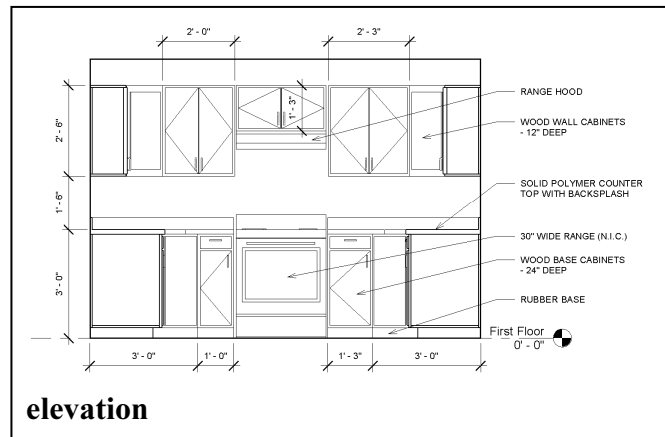
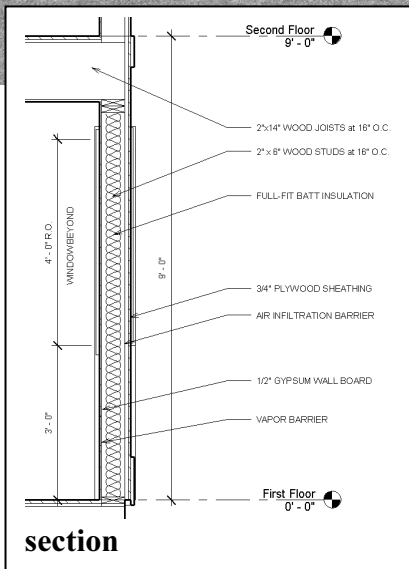


# Residential Design Using Revit® Architecture 2008



rendering



Daniel John Stine

**SDC**  
PUBLICATIONS

Schroff Development Corporation

[www.schroff.com](http://www.schroff.com)  
[www.schroff-europe.com](http://www.schroff-europe.com)

## Lesson 3

# Overview of Linework and Modify Tools::

It may seem odd to you, that, in a revolutionary 3D design program, you will begin by learning to draw and edit 2D lines and shapes. However, any 3D object requires, at a minimum, detailed information in at least two of the three dimensions; once two dimensions are defined, Revit can begin to automate much of the third dimension for you. Many building components (floors, roofs, ceilings, etc) and features (sub-room areas that will require its own room tag) will require you to draw the perimeter using 2D lines.

Many of the edit tools that are covered in this lesson are the same tools at are used to edit the 3D building components (i.e. walls, doors, etc.).

### *Exercise 3-1:*

#### *Lines and Shapes*

## Drawing lines

You will draw many 2D lines in Revit, typically in what is called *Sketch* mode. 2D Lines in Revit are extremely precise drawing elements. This means you can create very accurate drawings. Lines, or any drawn object, can be as precise as 8 decimal places (i.e. 24.99999999) or 1/256.

Revit is a vector based program. That means each drawn object is stored in a numerical database. When geometry needs to be displayed on the screen, Revit reads the from the project database to determine what to display on the screen. This means that the line will be very accurate at any scale or zoom magnification.

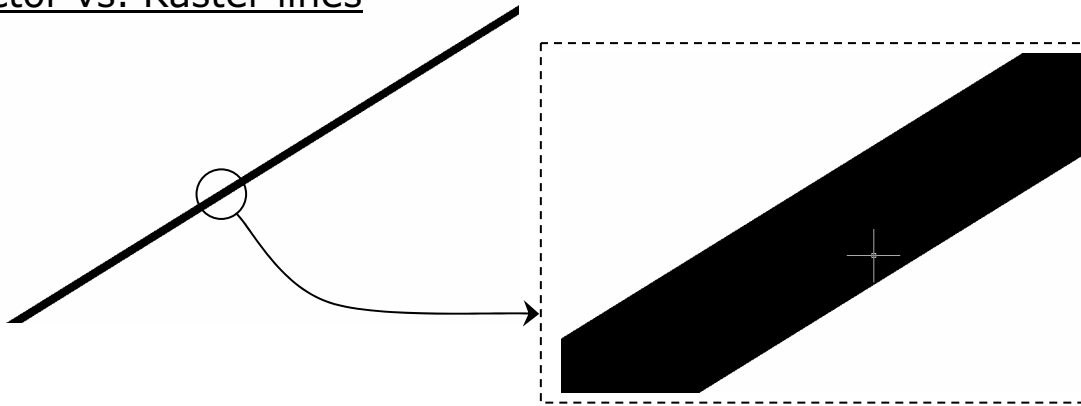
A raster based program, in contrast to vector based, is comprised of dots that infill a grid. The grid can vary in density, and is typically referred to as resolution (e.g. 600x800, 1600x1200, etc.). This file type is used by graphics programs that typically deal with photographs; such as Adobe Photoshop. There are two reasons this type of file is not appropriate for CAD programs:

1. A raster based line, for example, is composed of many dots on a grid (which also represents the lines width). When you zoom in (or magnify) the line, it starts to become pixilated; meaning you actually start to see each dot in the grid. In a vector file you can "infinitely" zoom in on a line and it will never become pixilated because the program recalculates the line each time you zoom in.

2. A CAD program, such as Revit, only needs to store the starting point and end point coordinates for each wall (for example); the dots needed to draw the wall are calculated on-the-fly for the current screen resolution. Whereas a raster file has to store each dot that represents the full length and width of the line (or lines in the wall example). This can vary from a few hundred dots to several thousand dots, depending on the resolution, for the same line.

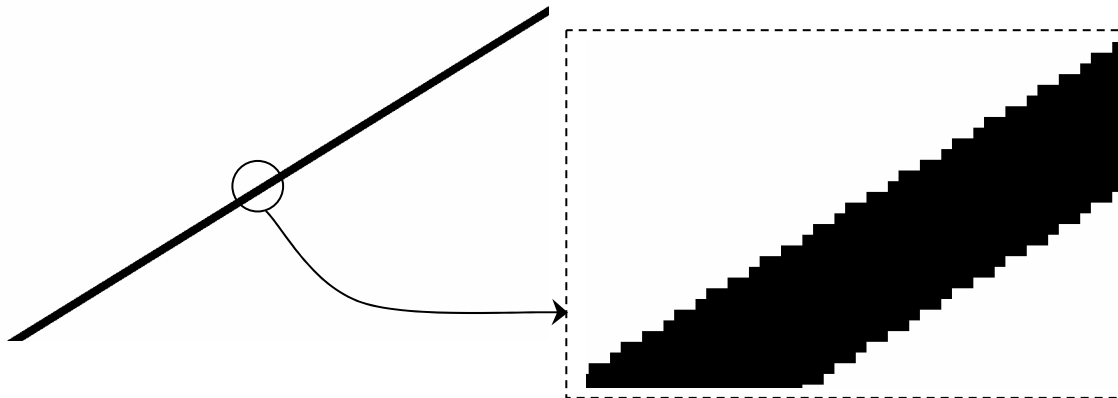
The following graphic illustrates this point:

### Vector vs. Raster lines



**Figure 3-1.1** Vector Line Example  
*File Size: approx. 33kb*

**Figure 3-1.1a** Vector Line Enlarged 1600%



**Figure 3-1.2** Raster Line Example  
*File Size: approx. 4.4MB*

**Figure 3-1.2a** Raster Line Enlarged 1600%

## The Detail Lines tool:

You will now study the *Detail Lines* tool.

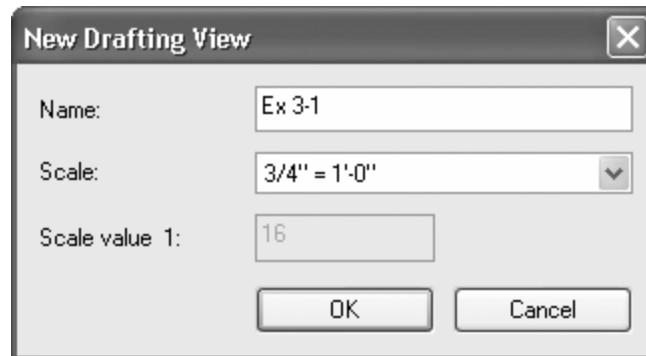
1. **Open** Revit.

Each time you start Revit, you are in the default project template. Therefore, you do not need to start a new project.

2. If Revit is already open, you should start a new project: Select **File** → **New** → **Project...**

The *Drawing Window* is set to the Level 1 floor plan view. The 2D drafting will be done in a drafting view. You will learn how to create one of these views next.

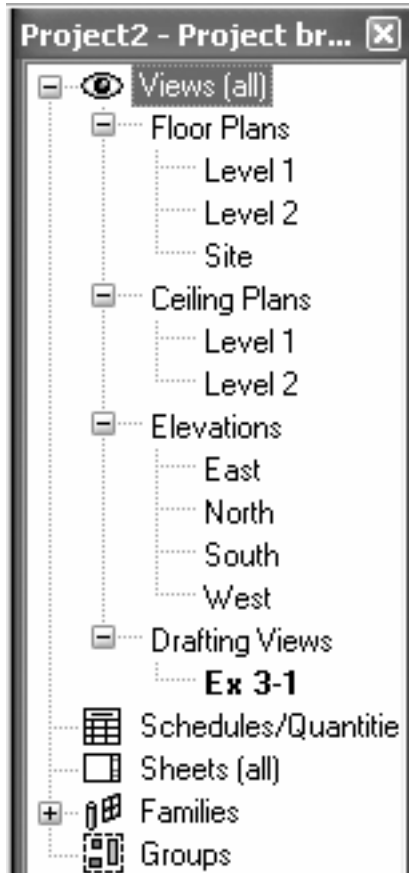
3. Select **View** → **New** → **Drafting View...**
4. In the *New Drafting View* dialog box, type **Ex3-1** for the *Name* and set the *Scale* to **3/4" = 1'-0"** by clicking the down-arrow at the right (Figure 3-1.3).



**Figure 3-1.3** New Drafting View dialog

The *Project Browser* now contains a category labeled *Drafting Views*. Each *Drafting View* created will be listed here.

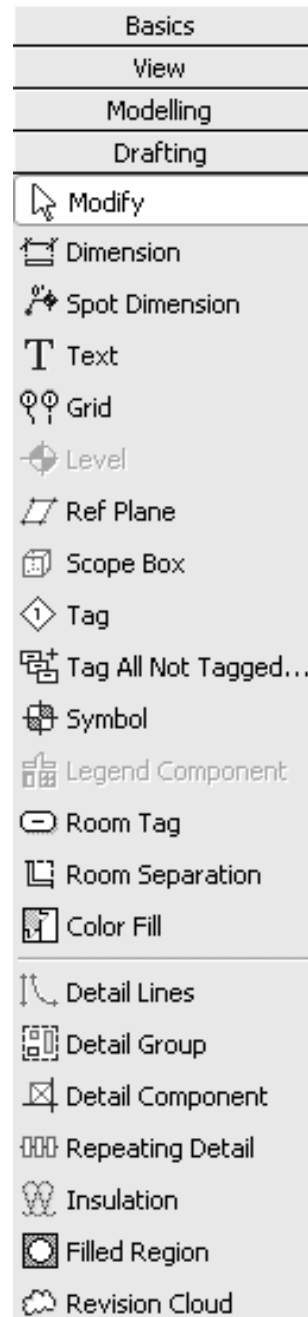
5. In the *Project Browser*, click the plus symbol next to the label *Drafting Views*; this will display the *Drafting Views* that exist in the current project (Figure 3-1.4).



**Figure 3-1.4** Project Browser: Drafting Views

You are now ready to start looking at the *Detail Lines* tool:

6. Select the **Drafting** tab within the *Design Bar*.



**Figure 3-1.5** Drafting tab

7. On the *Drafting* tab, select **Detail Lines** (Figure 3-1.5).

**TIP:** Do not use the "Lines" tool on the *Basic* tab.

8. **Draw a line** from the lower left corner of the screen to the upper right corner of the screen (by simply clicking two points on the screen).

**NOTE:** Do not drag or hold your mouse button down; just click (Figure 3-1.6).

After clicking your second point, you should notice the length and the angle of the line are graphically displayed; this information is temporary and will disappear when you begin the next line or cancel the tool.

You should also notice that the *Detail Lines* tool is still active, which means you could continue to draw additional lines on the screen.

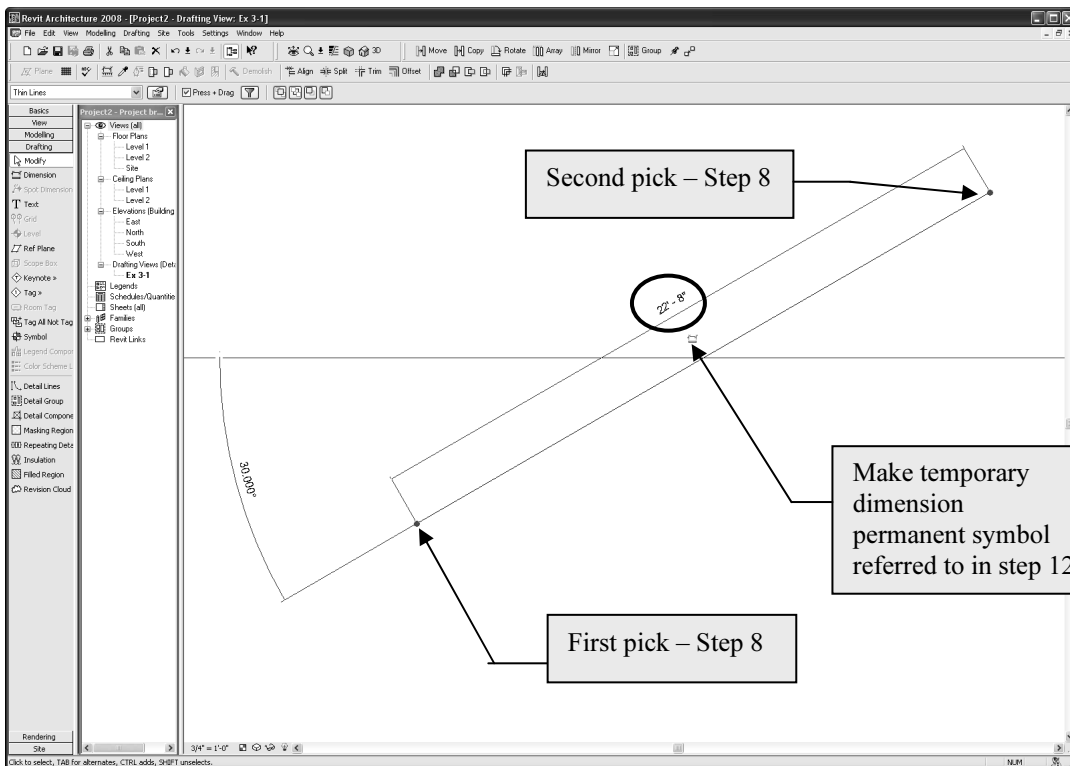
9. After clicking your second point, select the **Modify** tool from the *Drafting* tab.

Selecting *Modify* cancels the current tool and allows you to select portions of your drawing (for info/editing). Revit conveniently places the *Modify* tool on each tab in the *Project Browser*. **TIP:** Pressing the *Esc* key twice diverts Revit back to *Modify* mode.

### Did you make a mistake?

Whenever you make a mistake in Revit you can use the **UNDO** command to revert to a previous drawing state. You can perform multiple UNDO's all the way to your previous *Save*.

Similarly, if you press Undo a few too many times, you can use **REDO**.



**Figure 3-1.6** Your first detail line!

This constitutes your first line! However, as you are probably aware, it is not a very accurate line as far as length and angle are concerned.

Typically you need to provide information such as length and angle when drawing a line; you rarely pick arbitrary points on the screen like you did in the previous steps. Revit allows you to get close with the on-screen dimension and angle information. Most of the time you also need to accurately pick your starting point (for example: how far one line is from another or picking the exact middle point on another line).

Having said that, however, the line you just drew still has precise numbers associated with its length and angle; this information is displayed after the line is drawn. The dimension and angle information is displayed until you begin to draw another line or select another tool. While the dimensions are still visible, they can be used to modify the length and angle of the line; you will try that later.

10. If not already selected – click the **Modify** tool from the *Drafting* tab.

Notice that the temporary dimensions have disappeared.

While you are in *Modify* mode, you can select lines/objects in the current view.

11. Now **select the line** by clicking the mouse button with the cursor directly over the line. **FYI:** *Always the left button unless the right button is specifically mentioned.*

Notice that the temporary dimensions have returned.

## Making a temporary dimension permanent:

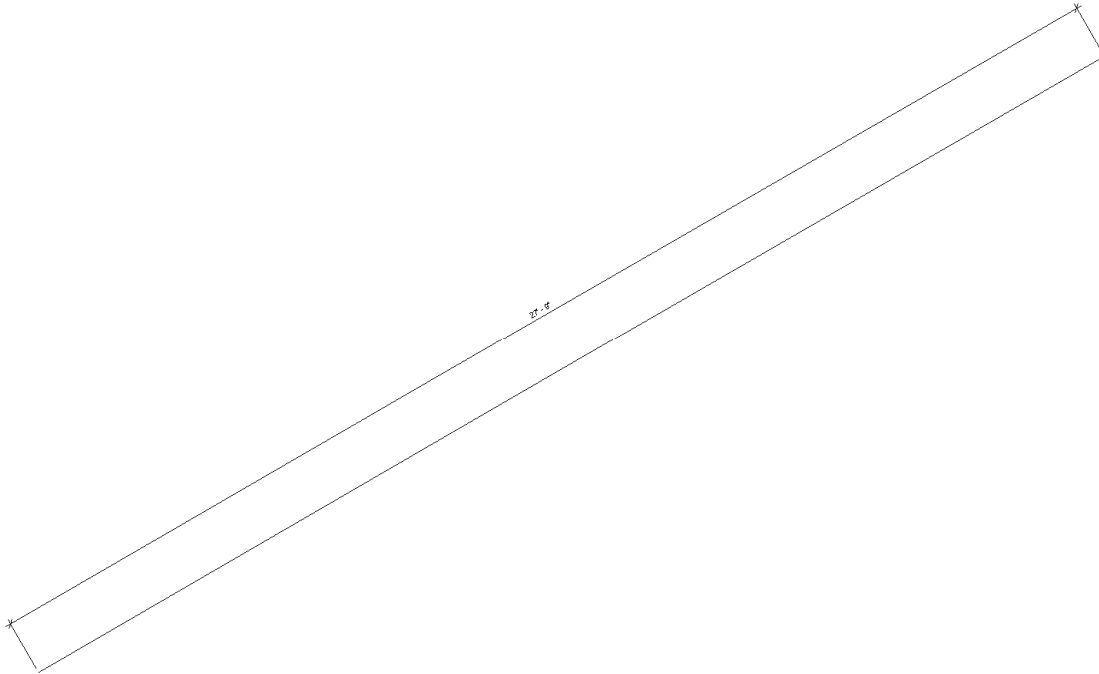
If, at any point, you want to make a temporary dimension permanent – you simply click the “make this temporary dimension permanent” symbol near the dimension. You will try this next.

12. With the diagonal line still selected, click the “make this temporary dimension permanent” symbol near the dimension (Figure 3-1.6).



13. Select **Modify** to unselect the line

The dimension indicating the length of the line is now permanent (Figure 3-1.7).



**Figure 3-1.7** Temp dimension converted to permanent dimension

## Changing the length of the line:

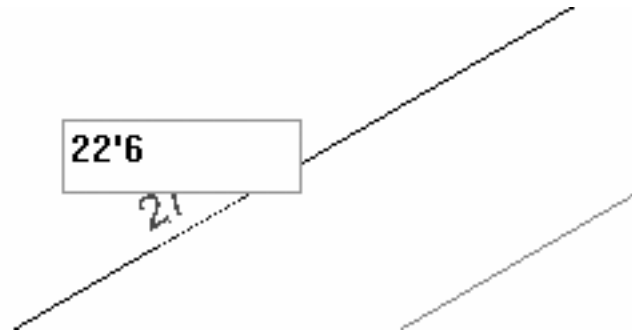
Currently, the line is approximately 27 – 30' long (27'-9" in Figure 3-1.7). If you want to change the length of the line to 22'-6" you select the line and then change the dimension text, which in turn, changes the line length. This can also be done with the temporary text – the key is that the line has to be selected. You will try this next.

14. In *Modify* mode, select the diagonal line.
15. With the line currently selected, click on the dimension text.

A dimension-text edit box appears directly over the dimension. Whatever you type for a dimension changes the line to match.

16. Type **22'6** and press **Enter** (Figure 3-1.8).





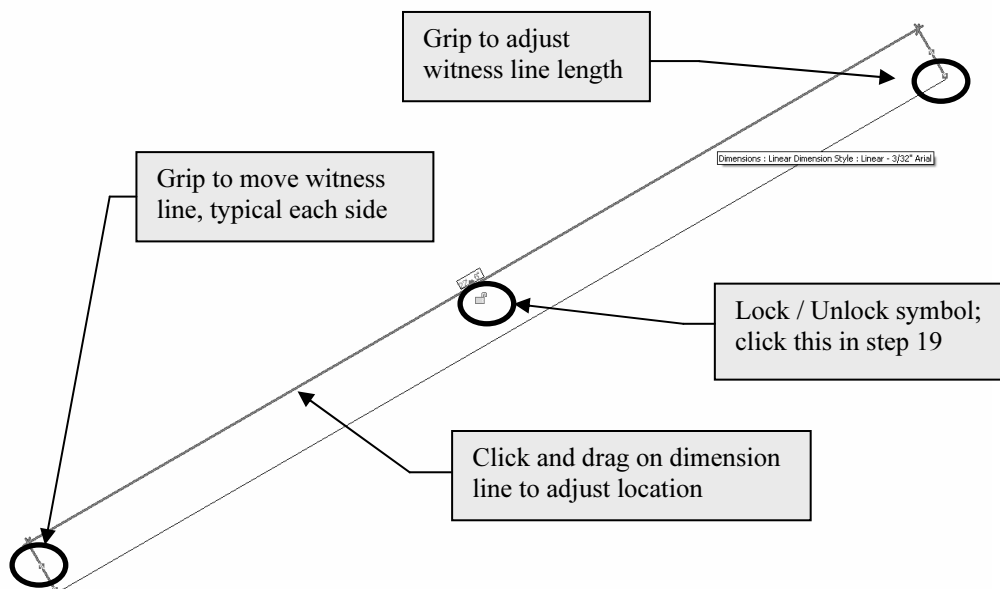
**Figure 3-1.8** Editing dimension to change line length

You should have noticed the line changed length. Revit assumes that you want the line to change length equally at each end, so the midpoint does not move.

### Locking dimensions:

Revit allows you to *Lock* a dimension; which prevents the dimension/line length from changing. You will investigate this now to help avoid problems later.

17. Make sure the line is *not* selected (press Esc or Modify).
18. Select the dimension (not the line) and note the following about the selected dimension (Figure 3-1.9).



**Figure 3-1.9** Selected dimension

19. Click on the **Lock/Unlock** (padlock) symbol to “Lock” the dimension (Figure 3-1.9).



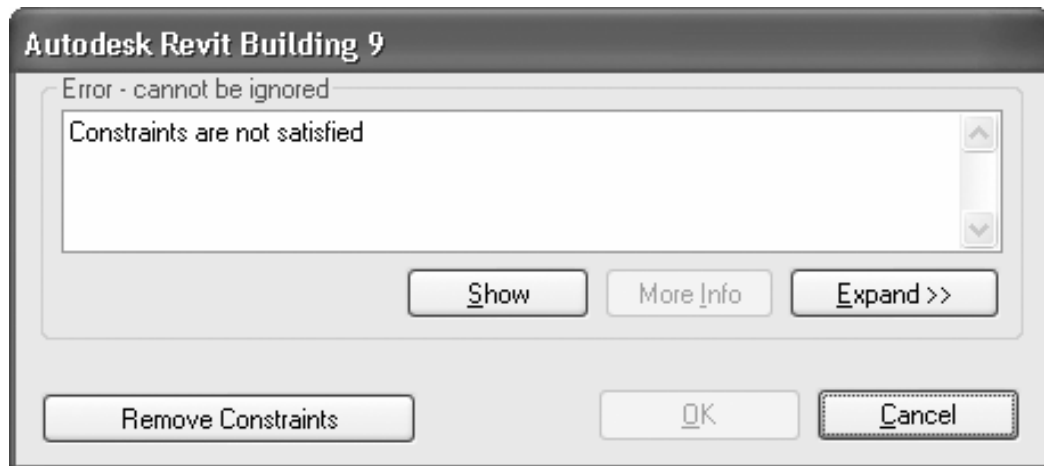
The dimension is now locked. Again, this means that you cannot change the dimension OR the line. The dimension is attached to the line in such a way that changing one affects the other. Next you will see what happens when you try to modify the dimension while it is locked.

Any time the line or dimension are selected you will see the Lock / Unlock symbol in the locked position.

**FYI:** Clicking it anytime it is visible will toggle the setting between locked and unlocked.

20. Select **Modify** to unselect the *Dimension*.
21. Select the line.
22. Click on the Dimension Text and attempt to modify the line length by typing **21'** and then press **Enter**.

You should now see the following error message (Figure 3-1.10), which indicates an error that cannot be ignored.

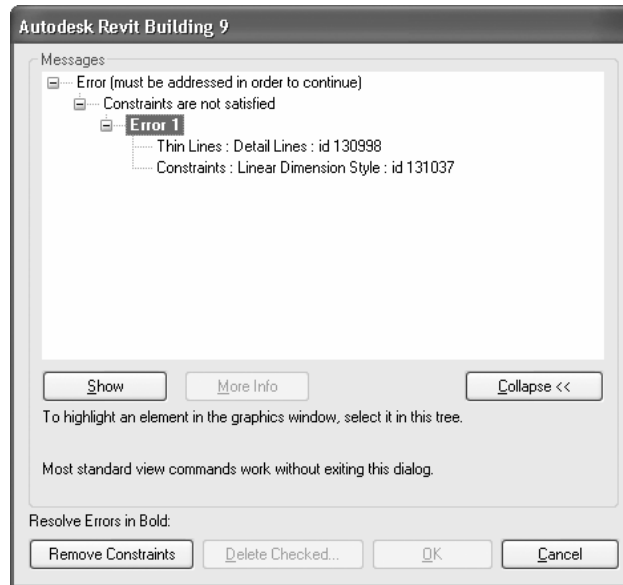


**Figure 3-1.10** Locked dimension error

As a new Revit user, you will likely see messages like this often; until you understand how Revit expects objects to work/relate to each other. This is helpful, because it identifies many items that deviate from your design intent or are not buildable in the real world.

If you are not sure what the constraint is, you may be able to figure it out by selecting the *Expand >>* button.

23. Click the **Expand >>** button.
24. Click the “plus” symbols to expand the view.



**Figure 3-1.11** Locked dimension error – expanded

The *Error 1* section indicates that a *Detail Line* is being constrained by a *Linear Dimension Style*.

At this point you can press *Cancel* to ignore the attempted change or click *Remove Constraints* to unlock the dimension (in this case). In this case you recall that you locked the dimension for a reason and do not want to change it:

25. Click **Cancel**.

Even though your current view is showing a relatively small area, i.e. *Drafting View*, it is actually an infinite drawing board.

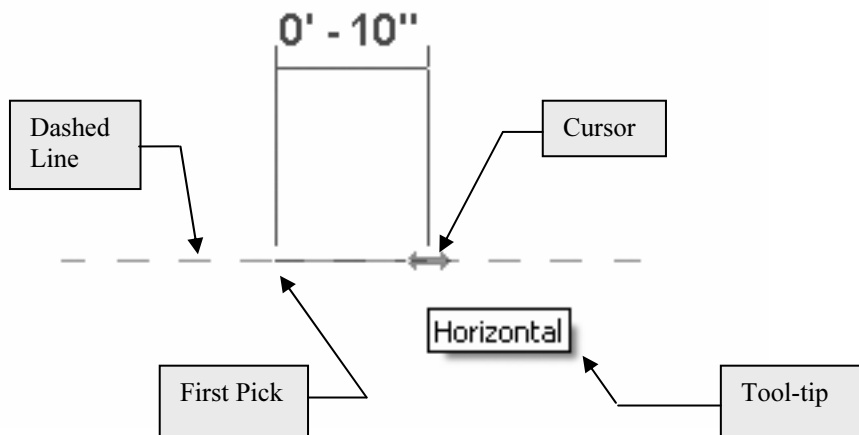
In architectural CAD drafting, everything is drawn “real-world” size (or full-scale); ALWAYS! If you are drawing a building, you might draw an exterior wall that is 600’-0” long. If you are drawing a window detail, you might draw a line that is 8” long. In either case you are entering that line’s actual length.

You could, of course, have an 8” line and a 600’-0” line in the same *Drafting View*. Either line would be difficult to see at the current drawing magnification (i.e. approx 22’ x 16’ area; also recall that your diagonal line is 22’-6” long). So you would have to zoom in to see the 8” line and zoom out to see the 600’-0” line. You will try this next:

## Draw an 8" line:

The next steps will walk you through drawing an 8" horizontal line. Revit provides more than one way to do this. You will try one of them now.

26. Select **Detail Lines** from the Drafting tab.
27. Pick a point somewhere in the upper left corner of the *Drawing Window*.
28. Start moving the mouse towards the right, and generally horizontal until you see a dashed reference line (extending in each direction of your line) appear on the screen as in Figure 3-1.12.



**Figure 3-1.12** Drawing a line with the help of Revit  
**TIP:** You will see a dashed horizontal line and a tooltip when the line is horizontal.

As you move the mouse left and right, you will notice Revit displays various dimensions that allow you to quickly draw your line at these oft used increments. Read the sidebar article in the next exercise to learn more about how to control the increments shown.

29. With the dashed line and *Tool-tip* visible on the screen, take your hand off the mouse (so you don't accidentally move it), and type: **8"** and then press **Enter**.

**TIP:** Remember, you have to type the inch symbol; Revit always assumes you mean feet unless you specify otherwise. A future lesson will review the input options in a little more detail.

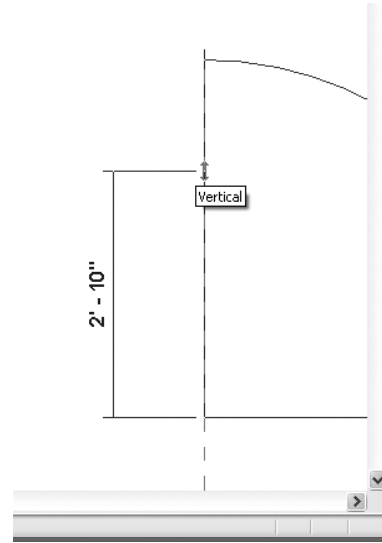
You have just drawn a line with a precise length and angle!

30. Use the **Tape Measure** tool to verify it was drawn correctly.

31. Use the **Zoom In Region** tool to enlarge the view of the 8" line.
32. Now use the **Zoom All to Fit** or **Previous Scroll/Zoom** tools so that both lines are visible again.

Draw a 600' line:

33. Select the **Detail Lines** tool and pick a point in the lower right corner of the *Drawing Window*.
34. Move the cursor (i.e. mouse) straight up from your first point so that the line snaps to the vertical and the dashed line appears (Figure 3-1.13).
35. With the dashed line and *tool-tip* visible on the screen, take your hand off the mouse (so you don't accidentally move it), and type: **600** and then press **Enter**.

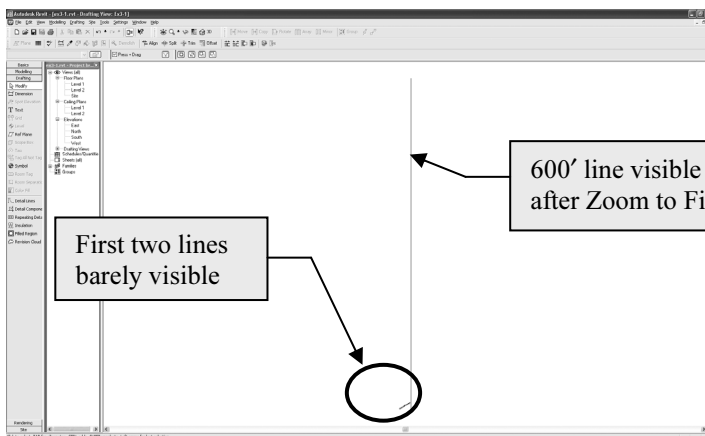


**Figure 3-1.13** Drawing another Detail Line; 600'-0" vertical line – lower right

**TIP #1:** Notice this time you did not have to type the foot symbol (').

**TIP #2:** You do not need to get the temporary dimension close to reading 600', the temporary dimension is ignored when you type in a value.

36. Press the **Esc** key twice to exit the *Drafting Lines* tool and return to the *Modify* tool.



**Figure 3-1.14** Detail view with three lines

Because the visible portion of the drawing area is only about 16' tall, you obviously would not expect to see a 600' line. You need to change the drawing's magnification (i.e. zoom out) to see it.

37. Use **Zoom All to Fit** to see the entire drawing (Figure 3-1.14).

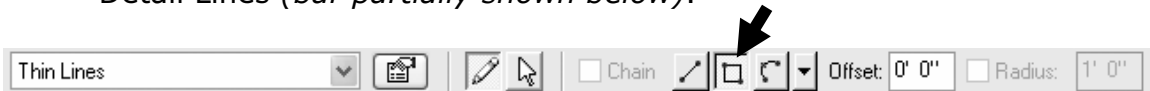
## Drawing Shapes:

Revit provides several tools to draw common shapes like square/rectangles, circles, ellipses. These tools can be found on the Options Bar while the *Detail Lines* tool is active. You will take a look at Rectangle and Circle now.

## Rectangle:

38. Use **Previous Scroll/Zoom** (or Zoom Region) to get back to the original view.
39. Select the **Detail Lines** tool from the *Drafting Tab*.

Notice the *Options Bar* has changed to show various options related to Detail Lines (*bar partially shown below*).



40. Select the **Rectangle** tool from the *Options Bar*.  
**TIP:** Hover cursor over icon to see tooltip until you learn the icons.
41. Pick the "**first corner point**" somewhere near the middle-bottom of the *Drawing Window* (Figure 3-1.15).

Notice the temporary dimensions are displaying a dimension for both the width and height.

At this point you can pick a point on the screen, trying to get the dimensions correct before clicking the mouse button. If you do not get the rectangle drawn correctly you can click on each dimension-text and change the dimension while the temporary dimensions are displayed; see the next two steps for the rectangle dimensions.

42. Draw a 2'-8"x4'-4" rectangle using the temporary dimensions displayed on the screen; if you do not draw it correctly do the following:
  - a. Click the dimension-text for the horizontal line and then type **2'-8"** and then press **Enter**.
  - b. Type **4'-4"** and then press **Enter** for the vertical dimension.

That's it; you just created your first rectangle!

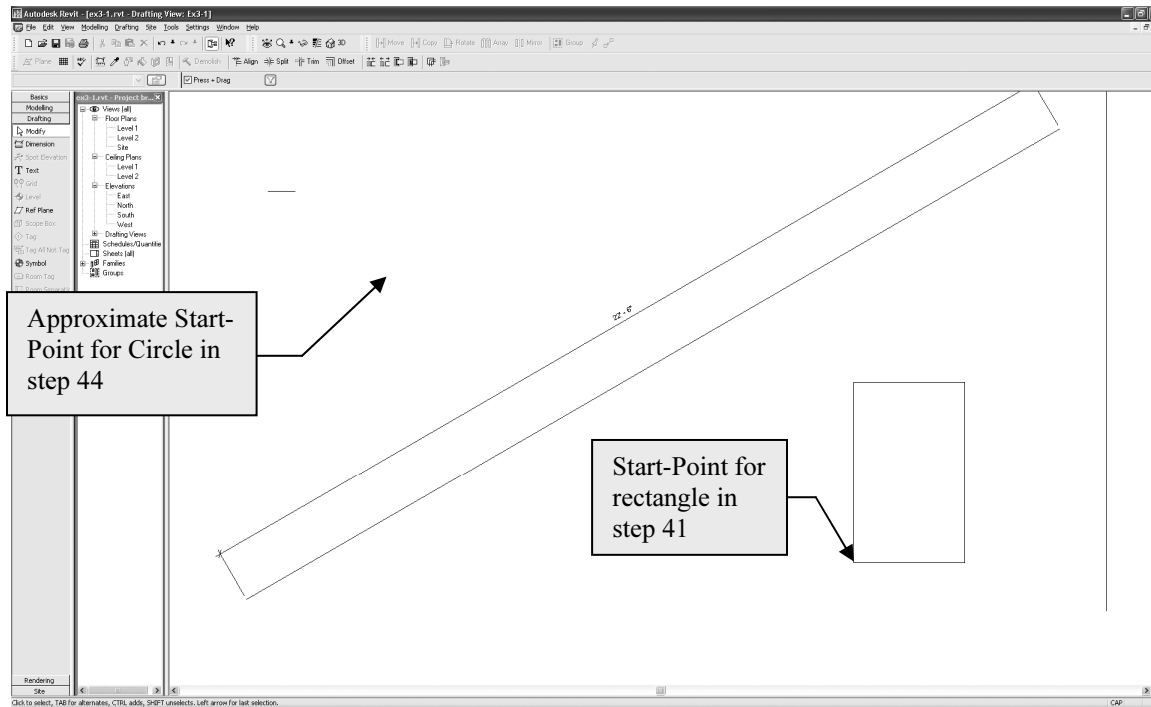


Figure 3-1.15 Drawing with Rectangle added

Circle:

43. With the *Detail Lines* tool active, select **Circle** from the *Options Bar*.

**TIP:** Click the down arrow (Figure 3-1.16).

44. You are now prompted to pick the center point for the circle: pick a point approximately as shown in Figure 3-1.15

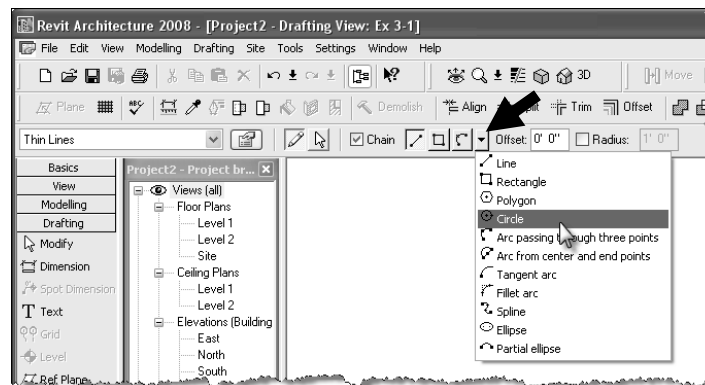
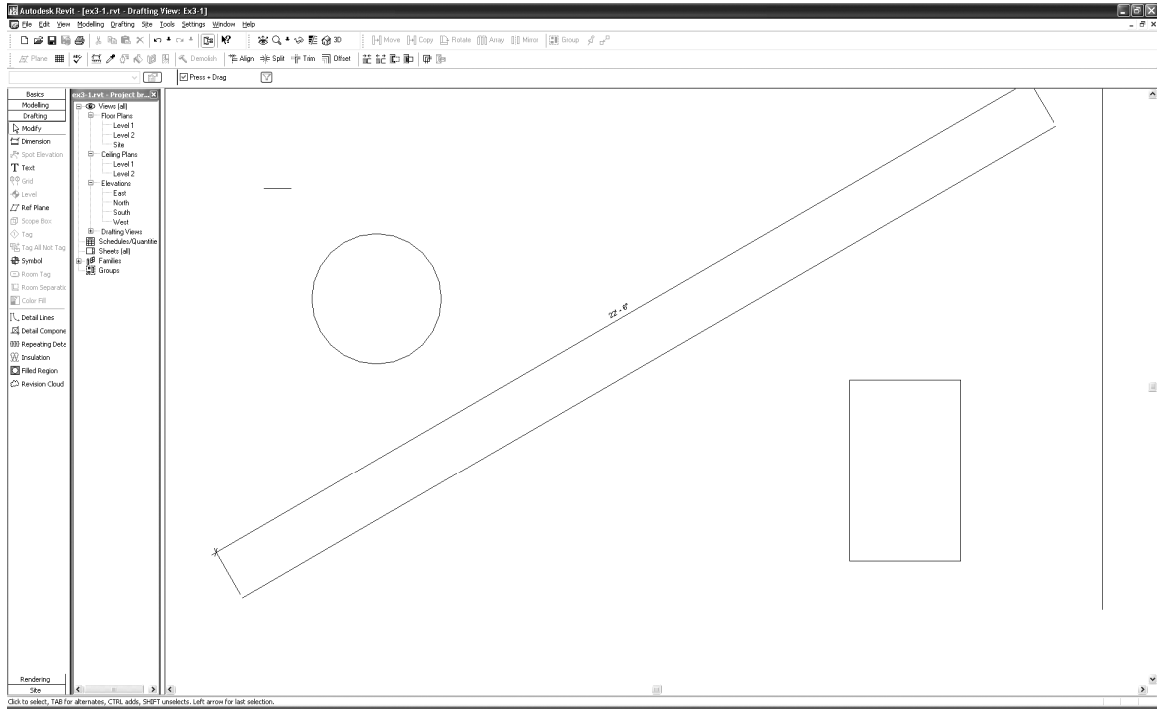


Figure 3-1.16 Detail Line Options

You should now see a dynamic circle and temporary dimension attached to your cursor (which allows you to visually specify the circle's size). Move your mouse around to see that you could arbitrarily pick a point on the screen to create a quick circle if needed, then proceed to step 45 where you will draw a circle with a radius of 1'-6 5/8".

45. Type **1'-6 5/8"** and then press **Enter** (Figure 3-1.17).



**Figure 3-1.17** Drawing with Circle added

46. **Save** your drawing as **ex3-1.rvt**.



## Exercise 3-2: Snaps

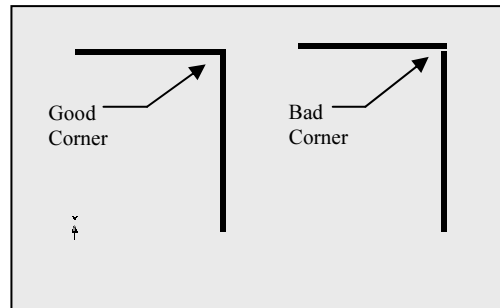
*Snaps* are tools that allow you to accurately pick a point on an object. For example: when drawing a line you can use *Object Snap* to select, as the start-point, the endpoint or midpoint of another line (or wall).

This feature is absolutely critical to drawing accurate technical drawings. Using this feature allows you to be confident you are creating perfect intersections, corners, etc. (Figure 3-2.1).

### Object Snaps Options:

You can use *Object Snaps* in one of two ways.

- "Normal" mode
- "Temporary Override" mode



**Figure 3-2.1** typical problem when *Snaps* are not used

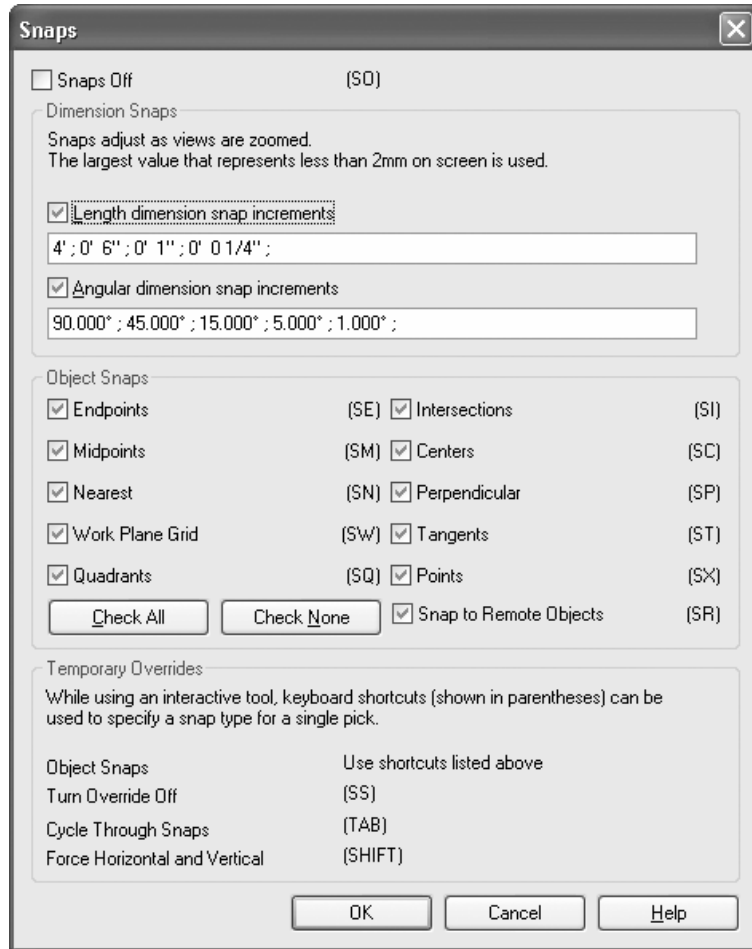
"Normal" *OSNAP* mode is a feature that constantly scans the area near your cursor when Revit is looking for user input. You can configure which types of points to look for. (**NOTE:** The term "normal" is not a Revit term, rather it is simply a description used in this book to differentiate this portion of the *Snaps* feature from the *Temporary Override* portion discussed next.)

Using a "Temporary Override" *Object Snap* for individual pick-points allows you to quickly select a particular point on an object. This option will temporarily disable the other *Object Snap* settings; which means you tell Revit to just look for the endpoint on an object (for the next pick-point only) rather than the three or four types being scanned for by the "normal" *Object Snaps* feature.

### Overview of the Snaps dialog box:

Revit provides a *Snaps* dialog box, where you specify which *Object Snaps* you want enabled. You will take a look at it next.

1. From the *Settings* pull-down menu, select ***Snaps...***



**Figure 3-2.2** Snaps dialog box; default settings

You should now see the *Snaps* dialog box (Figure 3-2.2). Take a minute to study the various settings that you can control with this dialog box. Notice the check box at the top that allows you to turn this feature off completely.

*Dimensions Snaps*

This controls the automatic dimensions that Revit suggests when you are drawing. Following the given format you could add or remove increments.

*Object Snaps*

This controls the “Normal” *Object Snaps* that Revit scans for while you are drawing. Un-checking an item tells Revit not to scan for it anymore. Currently, all Object Snaps are enabled (Figure 3-2.2).

*Temporary Overrides*

This area is really just information on how to use Temporary Overrides.

While drawing, you will occasionally want to tell Revit you only want to *Snap* to an Endpoint for the next pick. Instead of opening the *Snaps* dialog and unchecking every *Object Snap* except for Endpoint, you can specify a *Temporary Override* for the next pick. You do this by typing the two letters (in parentheses) in the *Object Snaps* area of the *Snaps* dialog (Figure 3-2.2).

2. Make sure the *Snaps Off* option is not checked in the upper-left corner of the dialog box (this turns Snaps completely off).
3. Click on the **Check All** button to make sure all *Snaps* are checked.
4. Click **OK** to close the *Snaps* dialog box.

## Snap Symbols:

By now you should be well aware of the Object Snap Symbols that Revit displays as you move your cursor about the drawing window (while you are in a tool like *Wall* and Revit is awaiting your input or pick-point).

If you hold your cursor still for a moment, while a snap symbol is displayed, a tool tip will appear on the screen. However, when you become familiar with the snap symbols you can pick sooner (rather than waiting for the tool tip to display) (Figure 3-2.3).

The TAB key cycles through the available snaps near your cursor.

| Symbol | Position      | Keyboard Shortcut |
|--------|---------------|-------------------|
| ✕      | Intersection  | SI                |
| □      | Endpoint      | SE                |
| △      | Midpoint      | SM                |
| ○      | Center        | SC                |
| ✕      | Nearest       | SN                |
| ⊥      | Perpendicular | SP                |
| ○      | Tangent       | ST                |

Figure 3-2.3 Snap symbols

Finally, typing **SO** turns all snaps off for one pick.

**FYI:**

The *Snaps* shown in Figure 3-2.2 are for Revit in general, not just the current project.

This is convenient; you don't have to adjust to your favorite settings for each Project or View (existing or new).

## Setting Object Snaps:

You can set Revit to have just one or all Snaps running at the same time. Let's say you have Endpoint and Midpoint set to be running. While using the *Wall* tool, you move your cursor near an existing *Wall*. When the cursor is near the end of the *Wall* you will see the Endpoint symbol show up, when you move the cursor towards the middle of the line you will see the Midpoint symbol show up.

The next step shows you how to tell Revit which Object Snaps you want it to look for.

First you need to **Open** the project from the previous Lesson.

1. **Open** project **ex3-1.rvt** (if not currently open).
2. Next, do a **Save-As** and name the project **ex3-2.rvt**.
3. As discussed previously, open the **Snaps** dialog box.
4. Make sure only the following *Snaps* are checked:
  - a. Endpoint
  - b. Midpoint
  - c. Center
  - d. Intersection
  - e. Perpendicular
5. Click **OK** to Close the dialog box.

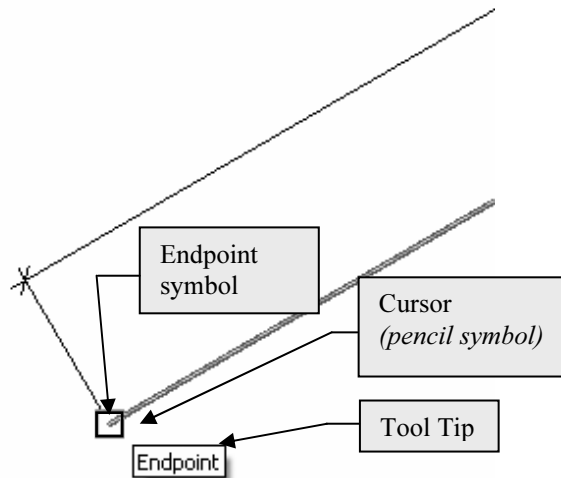
**For More Information:**

For more on using Snaps, search Revit's Help System for **Snaps**.

Then double-click the **Snap Points** or any other items found by the search.

Now that you have the *Snaps* set, you will give this feature a try.

6. Using the **Detail Lines** tool, move your cursor to the lower-left portion of the diagonal line (Figure 3-2.4).
7. Hover the cursor over the line's endpoint (without picking), when you see the *Endpoint Symbol* you can click to select that point.



**Figure 3-2.4** Endpoint SNAP symbol visible

### Just so you know

It is important that you see the *OSNAP* symbol before clicking. Also, once you see the symbol you should be careful not to move the mouse too much.

These steps will help to ensure accurate corners.

**While still in the Drafting Lines tool** you will draw lines using *Snaps* to draft accurately.

8. Draw the additional lines shown in **Figure 3-2.5** using the appropriate *Object Snap* (changing the selected *Snaps* as required to select the required points).
  - a. **TIP #1:** When using the *Drafting Lines* command you can draw several line segments without having to end the Line tool and then restart it for the next line segment; to do this you must have the *Chain* option checked on the *Options Bar*. After picking the start and end points for a line, the end point automatically becomes the first point for the next line segment; this continues until you finish the Line tool (i.e. right-click/Cancel or Esc twice).
  - b. **TIP #2:** At any point, while the Line tool is active, you can open the SNAP dialog box and adjust its settings. This will not cancel the line command.

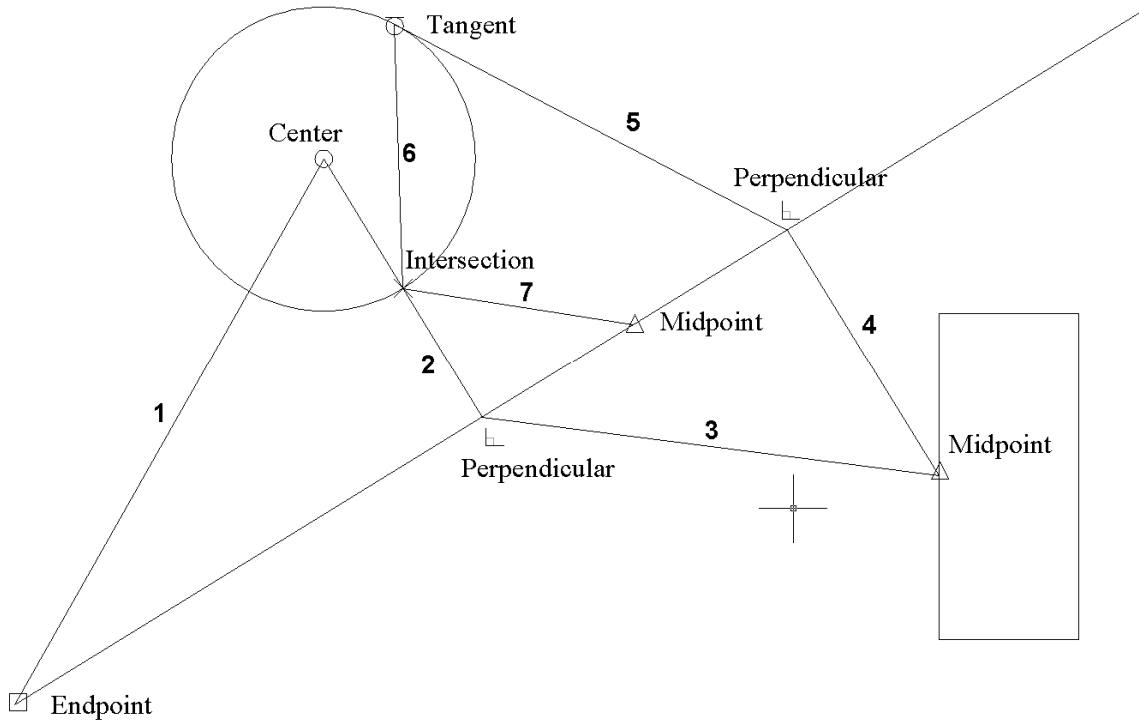


Figure 3-2.5 Lines to draw

9. **Save** your project.

### **This is a residential example?**

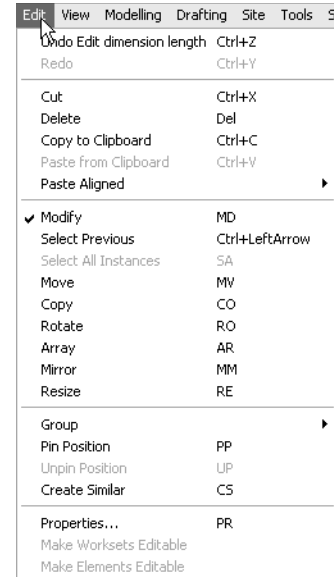
OK, this is not really an architectural example yet. However, the point here is to focus on the fundamental concepts and not architecture just yet.

## Exercise 3-3: Edit Tools

The Edit Tools are used often in Revit. Much time is spent tweaking designs and making code/client related revisions.

Example: you use the Design tools (e.g. Walls, Doors, Windows) to initially draw the project. Then you use the Edit tools to *Move* a wall so a room becomes larger, *Mirror* a cabinet so it faces in a different direction, and *Rotate* the furniture per the owner's instructions.

You will usually access the various Edit tools from the Standard or Edit Toolbars; you can also access them from the Edit Menu shown in Figure 3-3.1. (You can probably visualize what most of the commands do by its name.) The two letters shown to the right of a tool, in the menu, is its keyboard shortcut; pressing those two keys, one at a time, activates that tool.



**Figure 3-3.1** Edit menu

In this exercise you will get a brief overview of a few of the Edit tools; manipulating the tangled web of lines you have previously drawn.

1. **Open** project **ex3-2.rvt** from the previous lesson.
2. **Save-As ex3-3.rvt.**

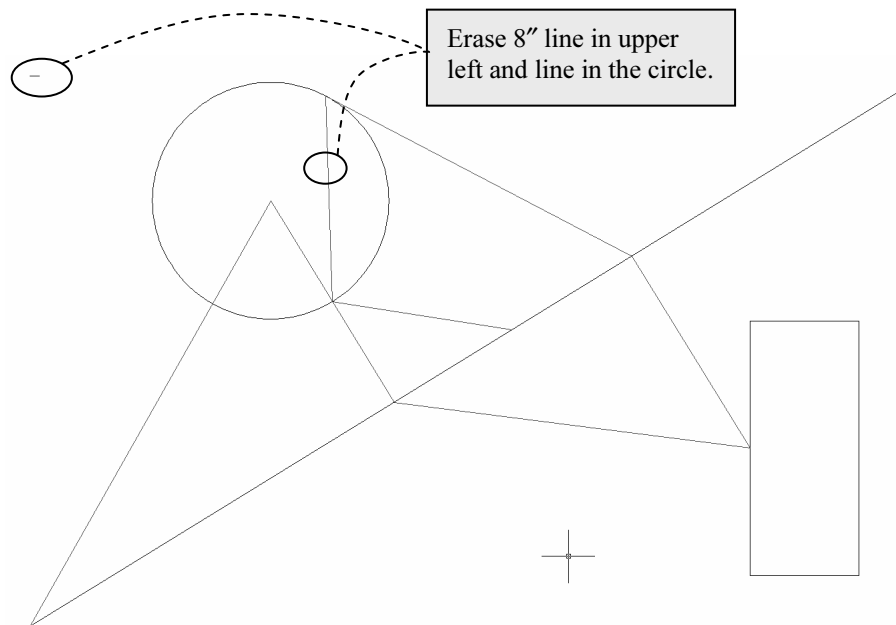
**FYI:** You will notice, in this book, that instructions or tools that have already been covered will have less "step-by-step" instruction.

### Delete tool:

It is no surprise that the *Delete* tool is a necessity, things change and mistakes are made. You can *Delete* one object at a time or several. Deleting objects is very easy; you select the Object (or Objects), and then pick the *Delete* icon. You will try this on two lines in your drawing.

3. While holding the Ctrl key, use the *Modify* tool to select the lines identified in **Figure 3-3.2**.

**TIP:** See the section below on *Selecting Entities*.

4. Select **Delete**.

**Figure 3-3.2** Lines to be erased

The lines are now deleted from the project.

## Selecting objects:

At this time we will digress and take a quick look at the various techniques for selecting entities in Revit. Most tools work the same when it comes to selecting objects.

When selecting entities, you have two primary ways to select them:

- Individually select entities one at a time
- Select several entities at a time with a window

You can use one, or a combination of both, methods to select objects (when using the Copy tool for example).

### Individual Selections:

When prompted to select entities (to copy or delete, for example), you simply move the cursor over the object and click; holding the Ctrl key to select multiple objects – then you typically select the tool you wish to use on the selected items.

*Continued on next page*



Window Selections:

Similarly, you can pick a Window around several objects to select them all at once. To select a window, rather than selecting an object as previously described, you select one corner of the window you wish to define (that is, you pick a point in "space"). Now, as you move the mouse you will see a rectangle on the screen that represents the windowed area you are selecting; when the Window encompasses the objects you wish to select – click the mouse.

You actually have two types of Windows you can select. One is called a **Window** and the other is called a **Crossing Window**.

**Window:**

This option allows you to select only the objects that are completely within the Window. Any lines that extend out of the Window are not selected.

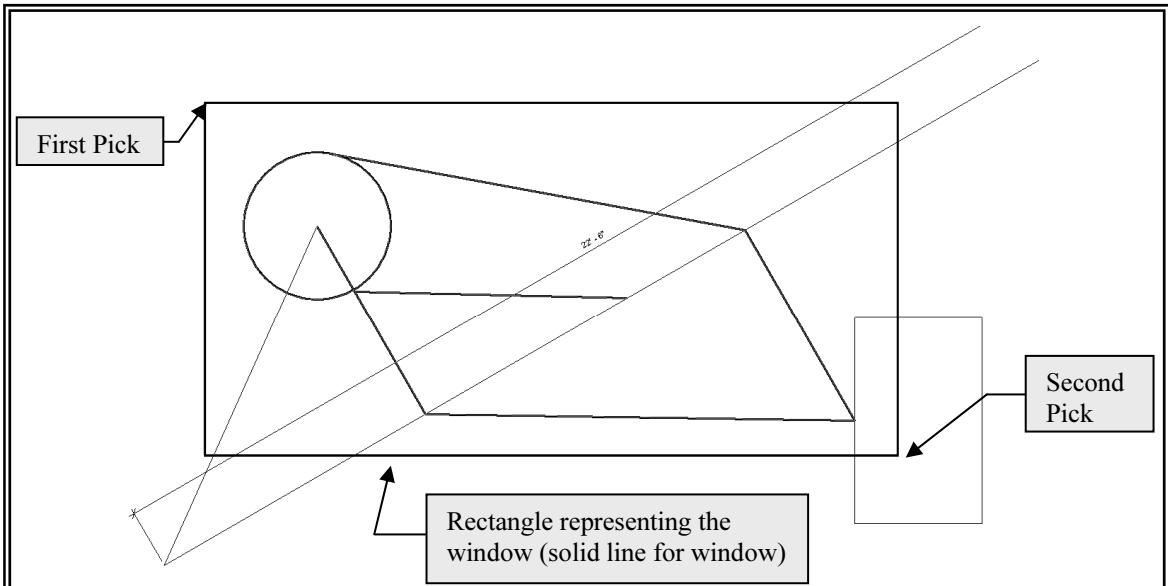
**Crossing Window:**

This option allows you to select all the entities that are completely within the Window and any that extend outside the Window.

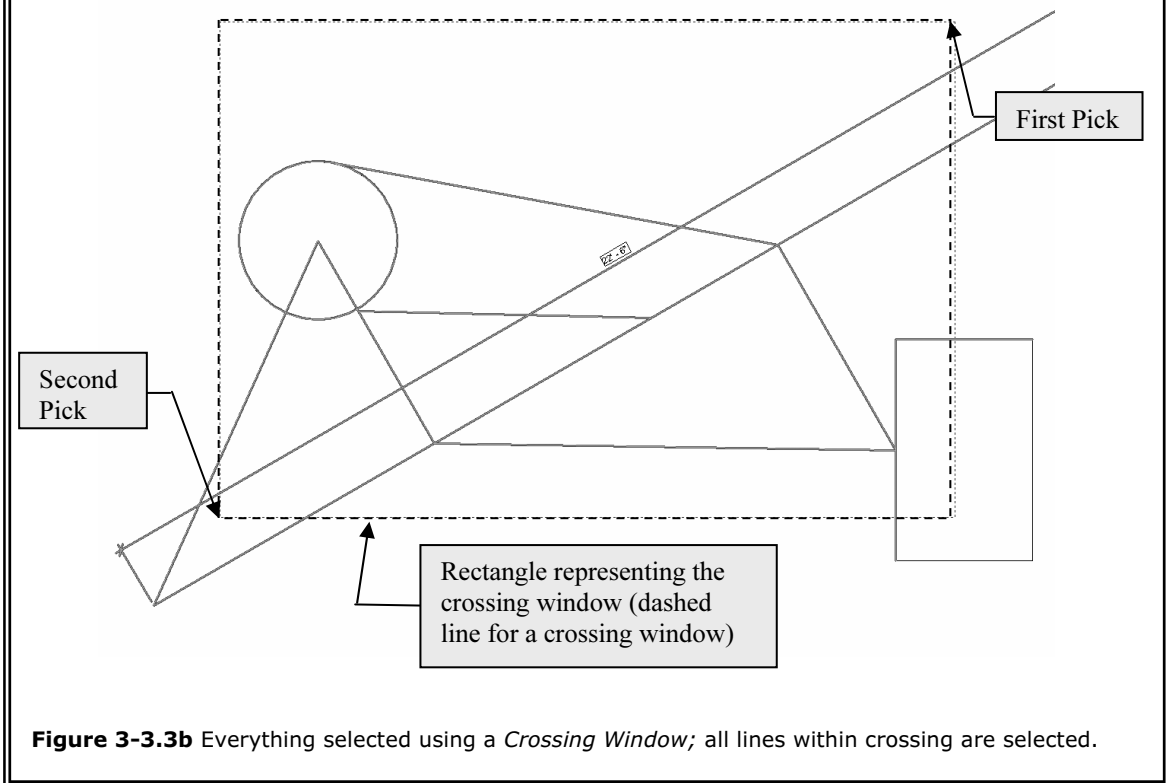
**Using Window versus Crossing Window:**

To select a *Window* you simply pick and drag from left to right to form a rectangle (Figure 3-3.3a).

Conversely, to select a Crossing Window, you pick and drag to define two diagonal points of the window from right to left (Figure 3-3.3b).



**Figure 3-3.3a** Six items selected using *Window*; only the lines within the window are selected.



**Figure 3-3.3b** Everything selected using a *Crossing Window*; all lines within crossing are selected.

## Copy tool:

The Copy tool allows you to accurately duplicate an object(s). You select the items you want to Copy and then pick two points that represent an imaginary vector (which provides both length and angle) defining the path used to copy the object to; you can also type in the length and angle if there are no convenient points to pick in the drawing. You will try both methods next.

5. **Select the circle.**

6. Select **Copy**. 

Notice the prompt at the bottom: click to enter move start point.

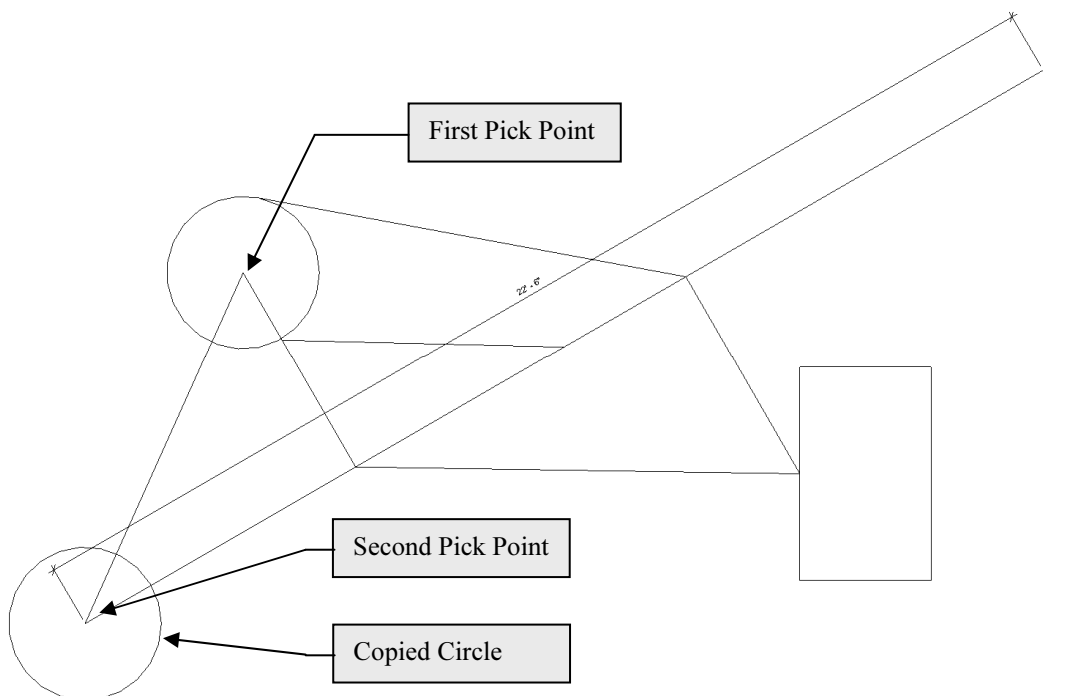
7. Pick the **Center** of the **Circle** (Figure 3-3.4).

**FYI:** You actually have three different Snaps you can use here: Center, Endpoint and Intersection. All occur at the exact same point.

Notice the prompt at the bottom; click to enter move end point.

8. Pick the Endpoint of the angled line in the lower left corner (Figure 3-3.4).

**FYI:** If you want to make several copies of the circle, select Multiple on the Options Bar.

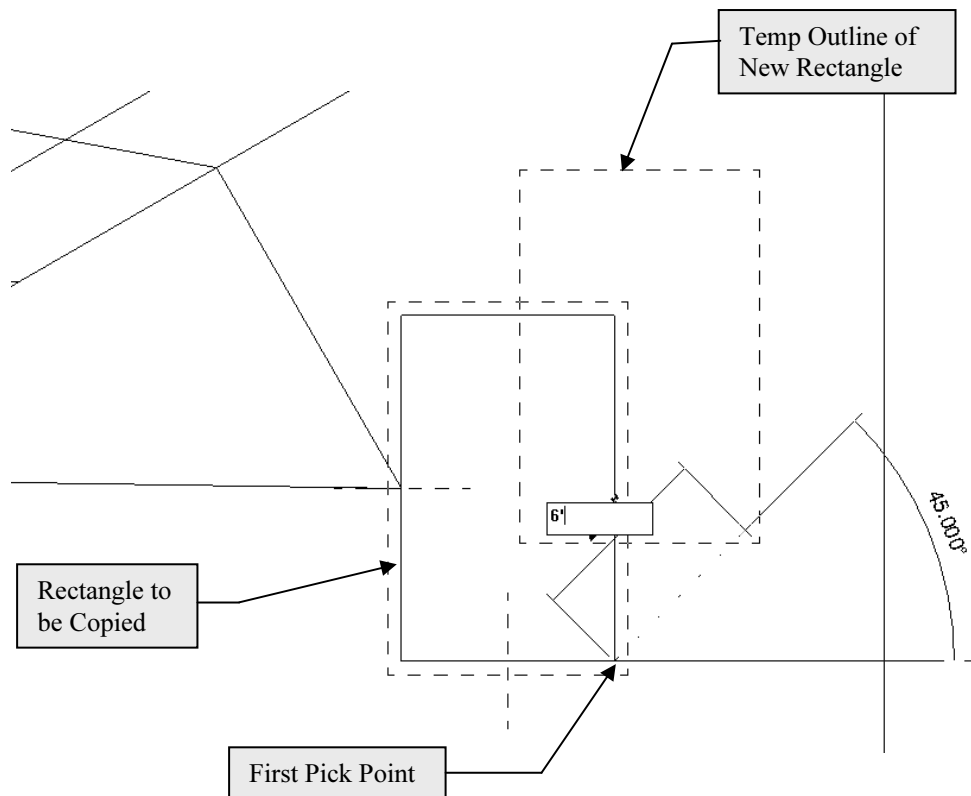


**Figure 3-3.4** Copied circle; also indicates points selected

9. **Select the rectangle** (*all four lines*).
10. Select **Copy**.
11. Pick an arbitrary point on the screen (*in this scenario it make no difference where you pick, you will see why in a moment*).

At this point you will move the mouse in the direction you want to copy the rectangle (until the correct angle is displayed) and then type in the distance, rather than picking a second point on the screen.

12. Move the mouse towards the upper right until 45 degrees displays and then type 6' and then press enter (Figure 3-3.5).



**Figure 3-3.5** copying rectangle; angle set visually and distance typed in

**NOTE:** Your drawing may look a little different than this one because your drawing is not totally to scale.

## Move tool:

The Move tool works exactly like the Copy tool except, of course, you move the objects rather than copy them. Given the similarity to the previous tool covered, the Move tool will not be covered here. You are encouraged to try it yourself.

## Rotate tool:

With the Rotate tool, you can arbitrarily or accurately rotate one or more objects in your drawing. When you need to Rotate accurately, you can pick points that define the angle (assuming points exist in the drawing to pick) or you can type a specific angle.

Rotate involves the following steps:

- Select object(s) to be rotated
- Select Rotate
- Determine if “center of rotation” symbol is where you want it.
  - If you want to move it, you simply drag it.
- Select a point to define a reference line and begin rotation.
- Pick a second point *using one of the following methods*:
  - By selecting other objects or using the graphic angle display or
  - You can type an angle and press enter.

13. **Select the new rectangle** you just copied (*all four lines*).

14. Select **Rotate**.

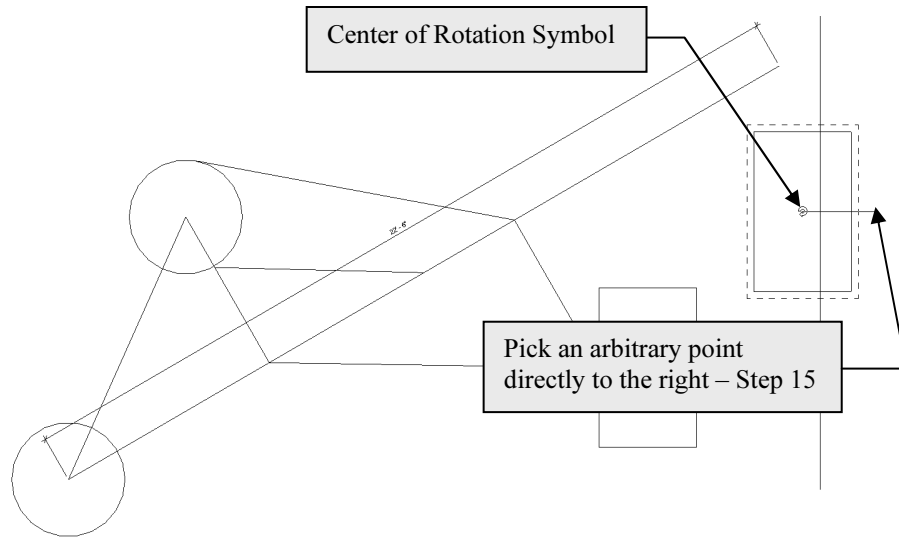


Notice that the “Center of Rotation” symbol, by default, is located in the center of the selected objects. This is the point about which the rotation will occur. See Figure 3-3.6.

You will not change the “Center of Rotation” at this time.

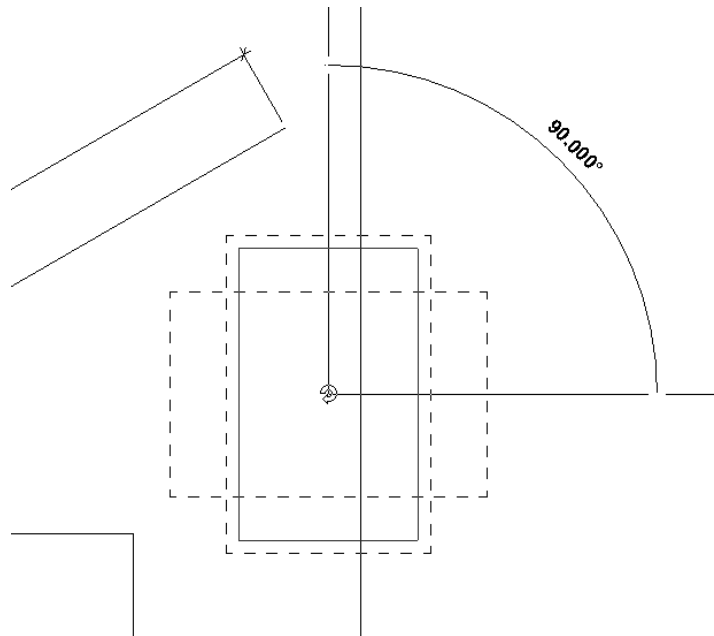
15. Pick a point directly to the right of the “Center of Rotation” symbol; this tells Revit you want to rotate the rectangle relative to the horizontal plane (Figure 3-3.6).

Now, as you move your mouse up or down, you will see the temporary angle dimension displayed. You can move the mouse until the desired angle is displayed and then click to complete the rotate or you can type the desired angle and then press enter. If you recall, the Snaps dialog box controls the increments of the angles that Revit displays (they are all whole numbers), so if you need to rotate something 22.45 degrees you must type it as Revit will never display that number as an option.



**Figure 3-3.6** Rotate tool – First Step; Select lines and then click Rotate

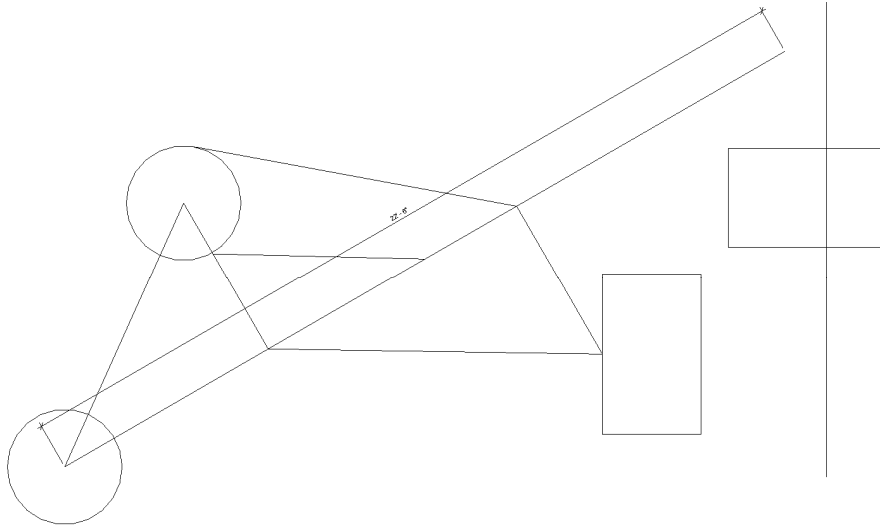
16. Move the mouse up and to the left until 90 degrees is displayed and then click to complete the rotate (Figure 3-3.7).



**Figure 3-3.7** Rotate tool – Last Step; Select angle visually or type angle

Thus, the previous steps just rotated the rectangle 90 degrees counter-clockwise; about its center point (Figure 3-3.8).

17. Select the **Undo** icon.

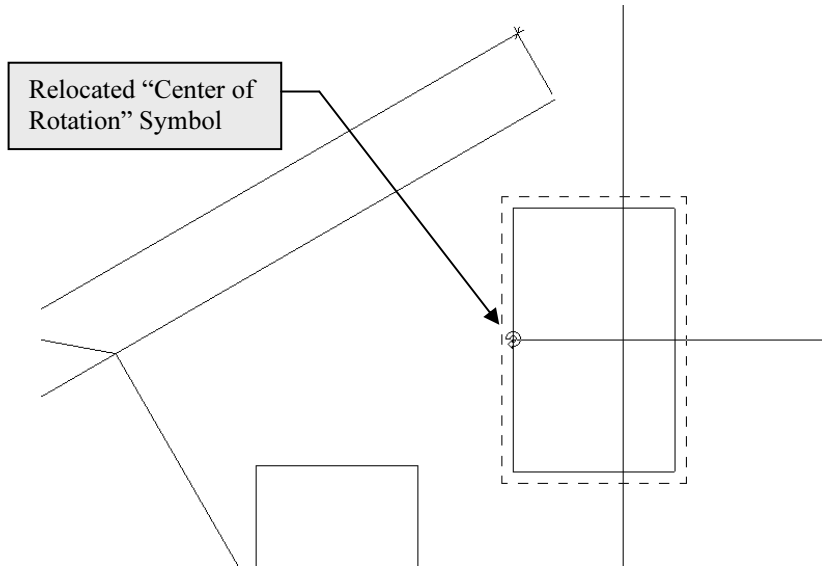


**Figure 3-3.8** Rotate tool – Rectangle rotated about its center point

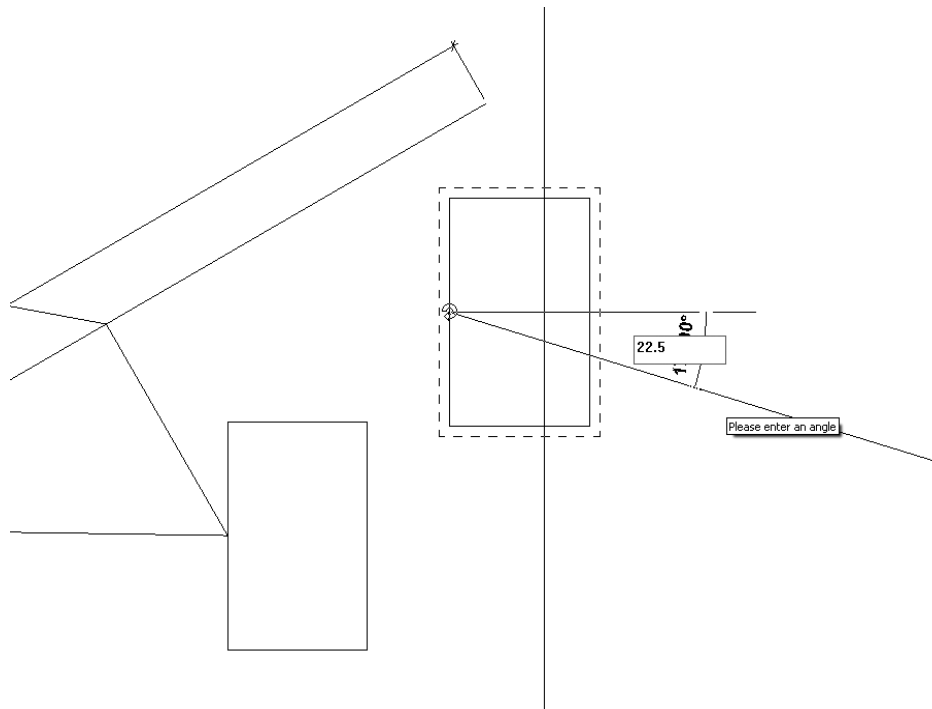
Now you will do the same thing, except with a different angle and “Center of Rotation”.

18. **Select the rectangle** and then pick **Rotate**.
19. Click and drag the “Center of Rotation” symbol to the left and *Snap* to the midpoint of the vertical line (Figure 3-3.9).
20. Pick a point to the right (creating a horizontal reference line).
21. Start moving your mouse downward and then type **22.5** and then press **Enter** (Figure 3-3.10).

The rectangle is now rotated 22.5 degrees in the clockwise direction (Figure 3-3.11).

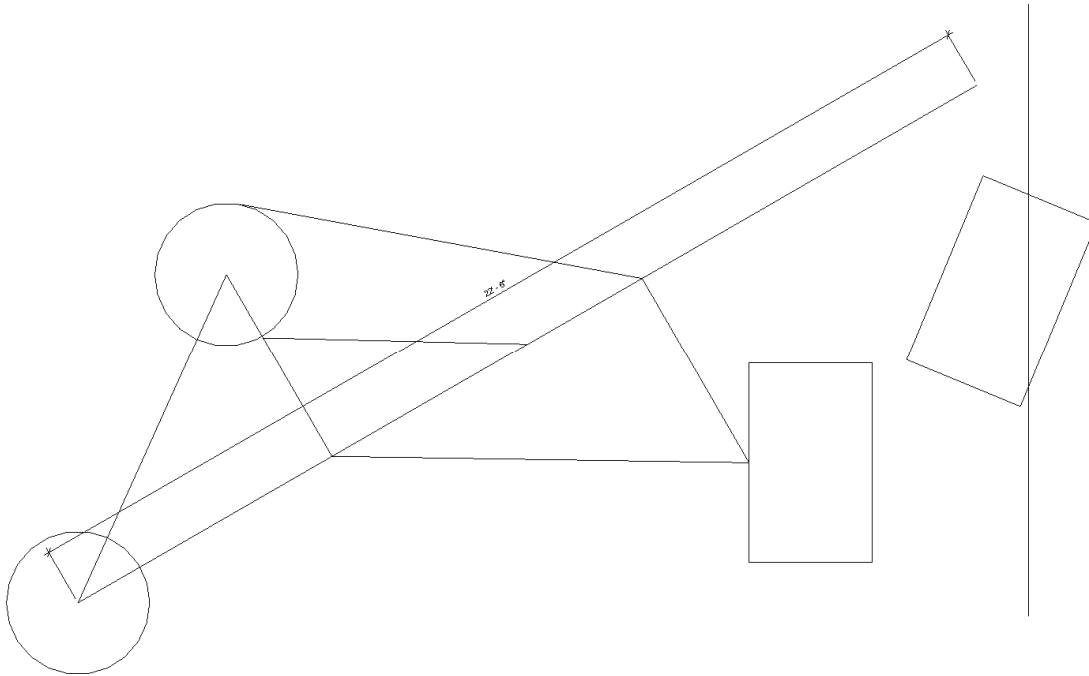


**Figure 3-3.9** Rotate tool; relocated "center of rotation"



**Figure 3-3.10** Rotate tool; typing in exact angle





**Figure 3-3.11** Rotate tool; Rectangle rotated 22.5 degrees

## Resize tool:

The Resize tool has steps similar to the Rotate tool. First you select what you want to resize (or scale), specify a scale factor and then you pick the base point. The scale factor can be provided by picks on the screen (graphical) or entering a numerical scale factor (e.g. 2 or .5; where 2 would be twice the original size and .5 would be half the original size).

Next you will use the Resize tool to adjust the size of the circle near the bottom.

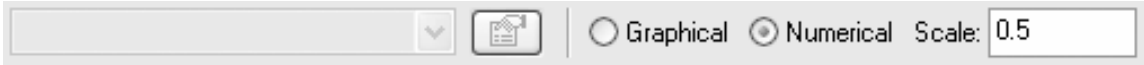
Before you resize the circle, you should use the **Modify** tool to note the **diameter** of the circle (select the circle and view its Temp dimensions). After resizing the circle, you will refer back to the Temp dimensions to note the change. This step is meant to teach you how to verify the accuracy and dimensions of entities in Revit.

22. **Select the circle** (the one at the bottom).

23. Select the **Resize** icon.



On the *Options Bar* you will specify a numeric scale factor of .5 to resize the circle to half its original size.



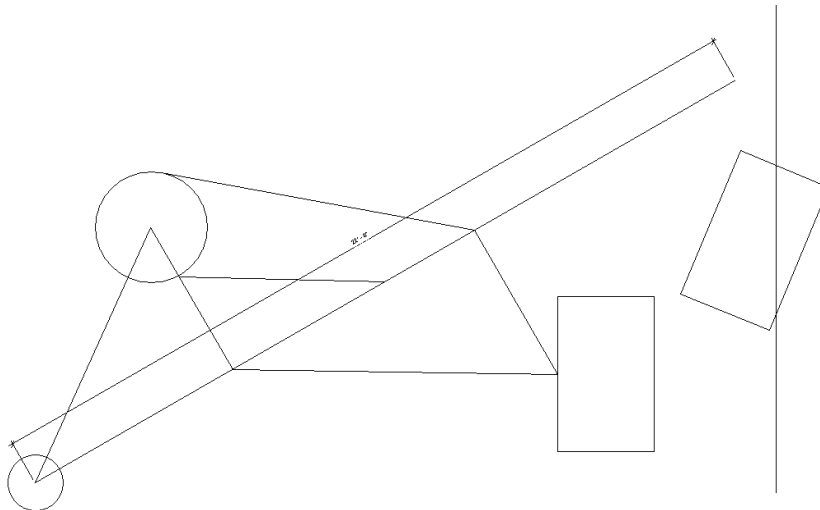
24. Click **Numerical** and then type **.5** in the text box (*see the Options Bar above*).

You are now prompted: **Click to enter origin on the status bar**. This is the base point about which the circle will be scaled (see examples in Figure 3-3.13 on the next page).

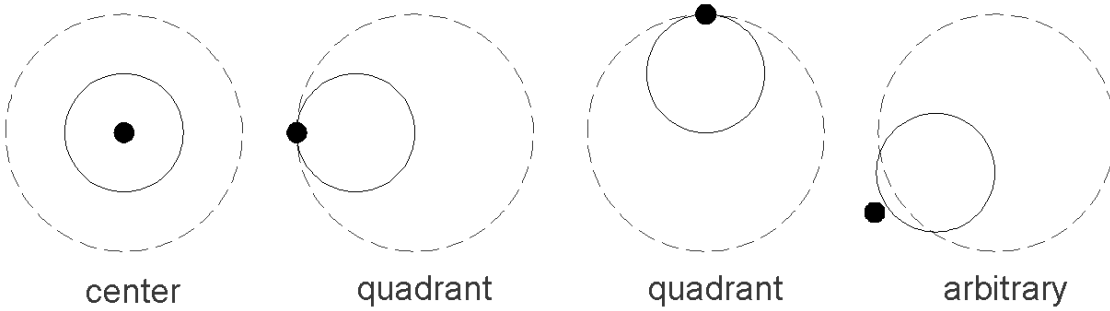
Now use the **Modify** tool to note the change in the size of the circle, from 1'-6 5/8" to 9 5/16" radius. A Scale Factor of .5 reduces the entities to half their original scale (Figure 3-3.12).

**Selecting the correct center of rotation (*base point*):**

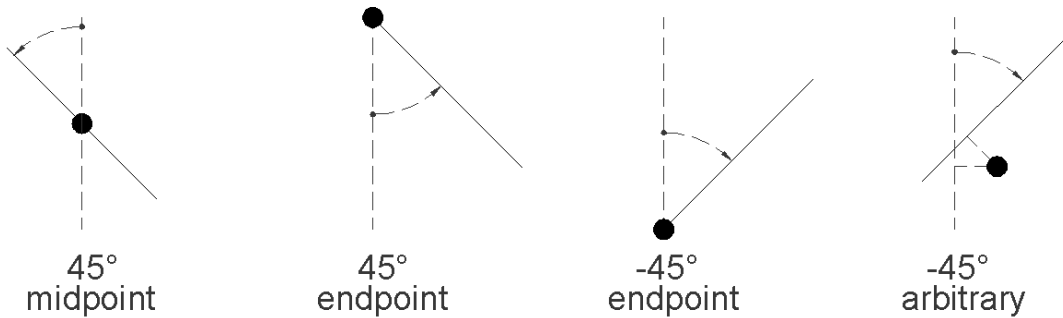
You need to select the appropriate Center of Rotation (or Base Point), for both the Resize and Rotate commands, to get the results desired. A few examples are shown in Figure 3-3.13. The dashed line indicates the original position of the entity being modified. The black dot indicates the base point selected.



**Figure 3-3.12** Resize circle; notice it is half the size of the other circle



Center of Rotation Options: Resize Command



Center of Rotation Options: Rotate Command

**Figure 3-3.13** Center of Rotation Options/the various results

This will conclude the brief tour of the Edit tools. Don't forget, even though you are editing 2D lines, the edit tools work the same way on 3D objects such as walls, doors, roofs, etc (exception: you cannot *Resize* walls, doors, etc.; these objects have to be modified by other methods. You would not typically change the door thickness when you changing its width and height as would happen if you could use the Resize tool on it).

As you surely noticed, the Edit menu and toolbar has a few other tools that have not been investigated yet. Many of these will be cover later in this book.

- 25. Save** your project (your project should already be named: ex3-3.rvt per step number 2 above).



Carter Residence

Images courtesy of LHB  
www.LHBcorp.com

## Exercise 3-4: Annotations

Annotations (text; notes) allow the designer/drafter to accurately describe the drawing. You will take a quick look at this feature now.

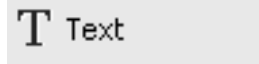
### Annotations:

Adding annotations to a drawing can be as essential as the drawing itself. Often the notes (i.e. annotations) describe something about a part of the drawing that would be difficult to discern from the drawing alone.

For example: a wall framing drawing showing a bolt may not indicate, graphically, how many bolts are needed or at what spacing. The note might say "5/8" anchor bolt at 24" O.C."

Next you will add text to your drawing.

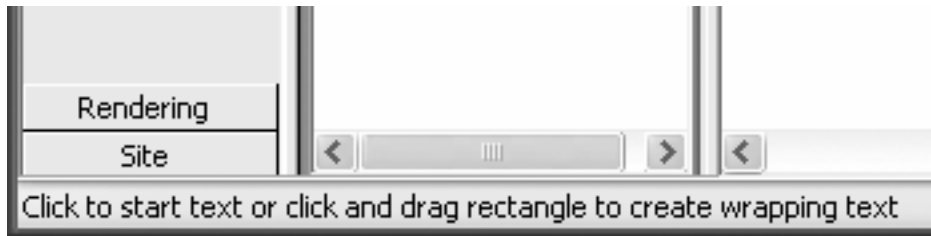
1. **Open** project **ex3-3.rvt** from the previous lesson.
2. **Save-As ex3-4.rvt.**
3. Use **Zoom** if required, to see the entire drawing (except for the 600' line, it can run off the screen).
4. From the Drafting tab (or the Basic tab), select the **Text** tool. (Notice that some tools are repeated on additional tabs for convenience.)



From the Drafting pull-down menu you can see that the keyboard shortcut for the *Text* tool is TX. Thus, at any time you can type T and then X to activate the Text tool, if you have another command active, Revit will cancel it.

Experienced/efficient designers use a combination of keyboard shortcuts and mouse clicks to save time. For example, while your left hand is typing TX, your right hand can be moving toward the location where you want to insert the text.

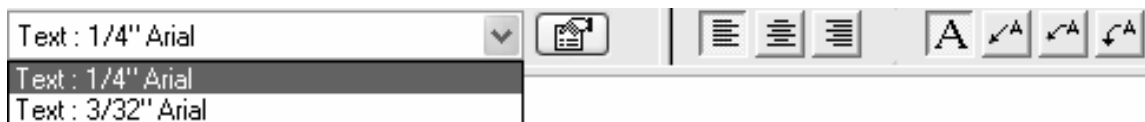
Notice the current *Prompt* on the status line at the bottom of the screen; you are asked to "Click to start text or click and drag to create text wrapping". By clicking on the screen you create one line of text (starting at the point picked) and press *Enter* to create additional lines. By clicking and dragging you specify a window, primarily for the width, which causes Revit to automatically move text to the next line (i.e. text wrapping) when the text no longer fits within the window (Figure 3-4.1).



**Figure 3-4.1** Status line while Text tool is active

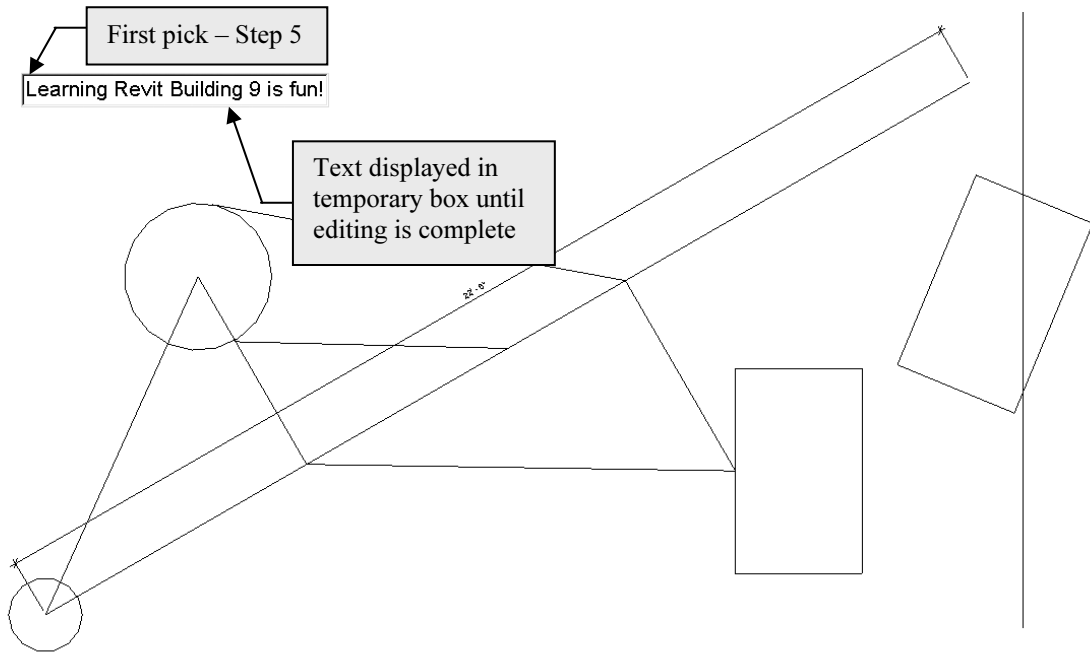
You should also notice the various text options, available on the Options Bar, while the Text tool is active (Figure 3-4.2). You have two text heights (loaded from the template file you started with), text justification icons (Left, Center, right) and the option to attach leaders (i.e. pointing arrows) to your drawings. The text tool will be covered in more detail later in this book.

**FYI:** The text heights shown (i.e. 1/4", 3/32") are heights the text will be when printed on paper, regardless of drawing scale.



**Figure 3-4.2** Options Bar with the text tool active

5. Pick a point in the upper left portion of the view as shown in Figure 3-4.3.
6. Type **Learning Revit Architecture 2008 is fun!**
7. Click anywhere in the view (except on the active text).



**Figure 3-4.3** Text tool; Picking first point and typing text.

As soon as you complete the text edit, the text will still be selected and the “Move” and “Rotate” symbols will be displayed near the text; this allows you to more quickly *Move* or *Rotate* the text after it is typed (Figure 3-4.4).



**Figure 3-4.4** Text tool; text typed with Move / Rotate symbols showing.

8. Finish the text tool completely by clicking away from the text

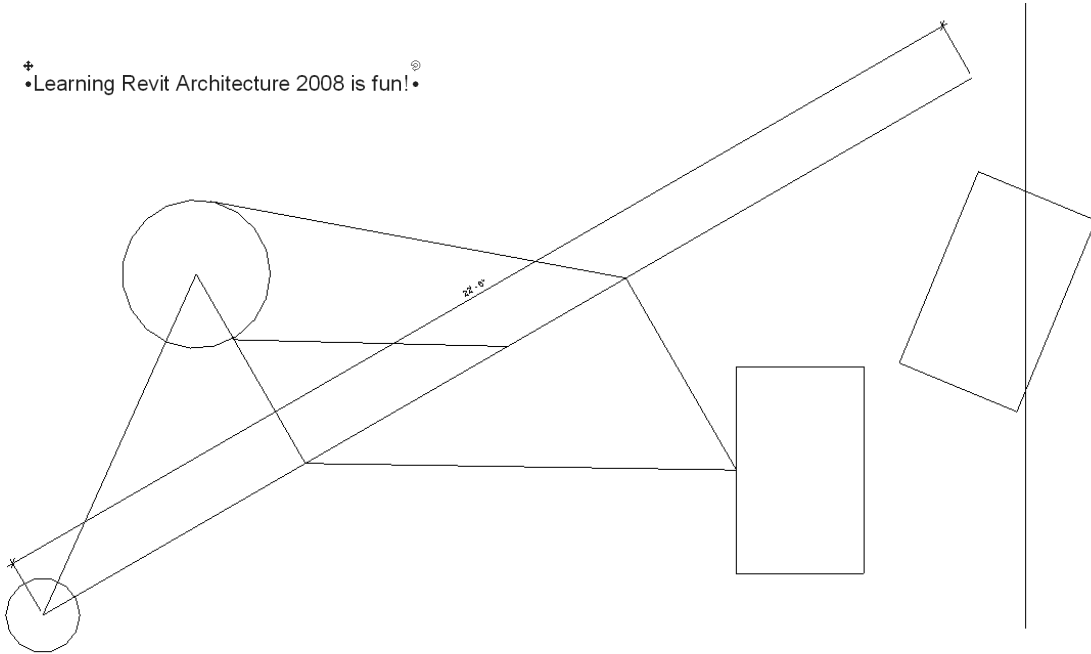
**TIP:** Notice that the text is no longer selected and the symbols are gone.

Your text should look similar to Figure 3-4.5. Text can be Moved and Rotated with the tools on the *Modify Toolbar*.

9. Print your drawing, refer back to page 2-15 for basic printing information; your print should fit the page and look similar to Figure 3-4.5.

10. **Save** your project.

+  
•Learning Revit Architecture 2008 is fun!•



**Figure 3-4.5** Text tool; text added to current view



Carter Residence

*Images courtesy of LHB  
www.LHBcorp.com*

**Self-Exam:**

The following questions can be used as a way to check your knowledge of this lesson. The answers can be found at the bottom of the page.

1. Revit is only accurate to three decimal places. (T/F)
2. The diamond shaped Snap symbol represents the Midpoint snap. (T/F)
3. You can move or rotate text via symbols when text is selected. (T/F)
4. Use the \_\_\_\_\_ tool to duplicate objects.
5. When selecting objects, use the \_\_\_\_\_ \_\_\_\_\_ to select all the objects in the selection window and all objects that extend through it.

**Review Questions:**

The following questions may be assigned by your instructor as a way to assess your knowledge of this section. Your instructor has the answers to the review questions.

1. Revit is a raster based program. (T/F)
2. The "Center of Rotation" you select for the Rotate and Resize commands are not important. (T/F)
3. Entering 16 for a distance, actually means 16'-0" to Revit. (T/F)
4. Use the *Detail Lines* tool, with \_\_\_\_\_ checked on the *Options Bar*, to create squares.
5. You can change the height of the text from the *Type Selector*. (T/F)
6. Pressing the \_\_\_\_\_ key cycles you through the snap options.
7. Where do the two predefined text heights come from? \_\_\_\_\_
8. Specifying degrees with the Rotate tool, you must type the number when Revit does not display the number you want, the increments shown on-screen are set in the \_\_\_\_\_ dialog box.
9. List all the Snap points available on a circle (ex. Line: endpoint, midpoint, nearest) \_\_\_\_\_.
10. The Snaps Off option must not be checked in the Snaps dialog box to automatically and accurately select snap points while drawing. (T/F)

*Self-Exam Answers:*

**1 – F, 2 – F, 3 – T, 4 – Copy, 5 – Crossing Window**



**Notes:**