

Principles and Practice:

An Integrated Approach to Engineering Graphics and AutoCAD 2008

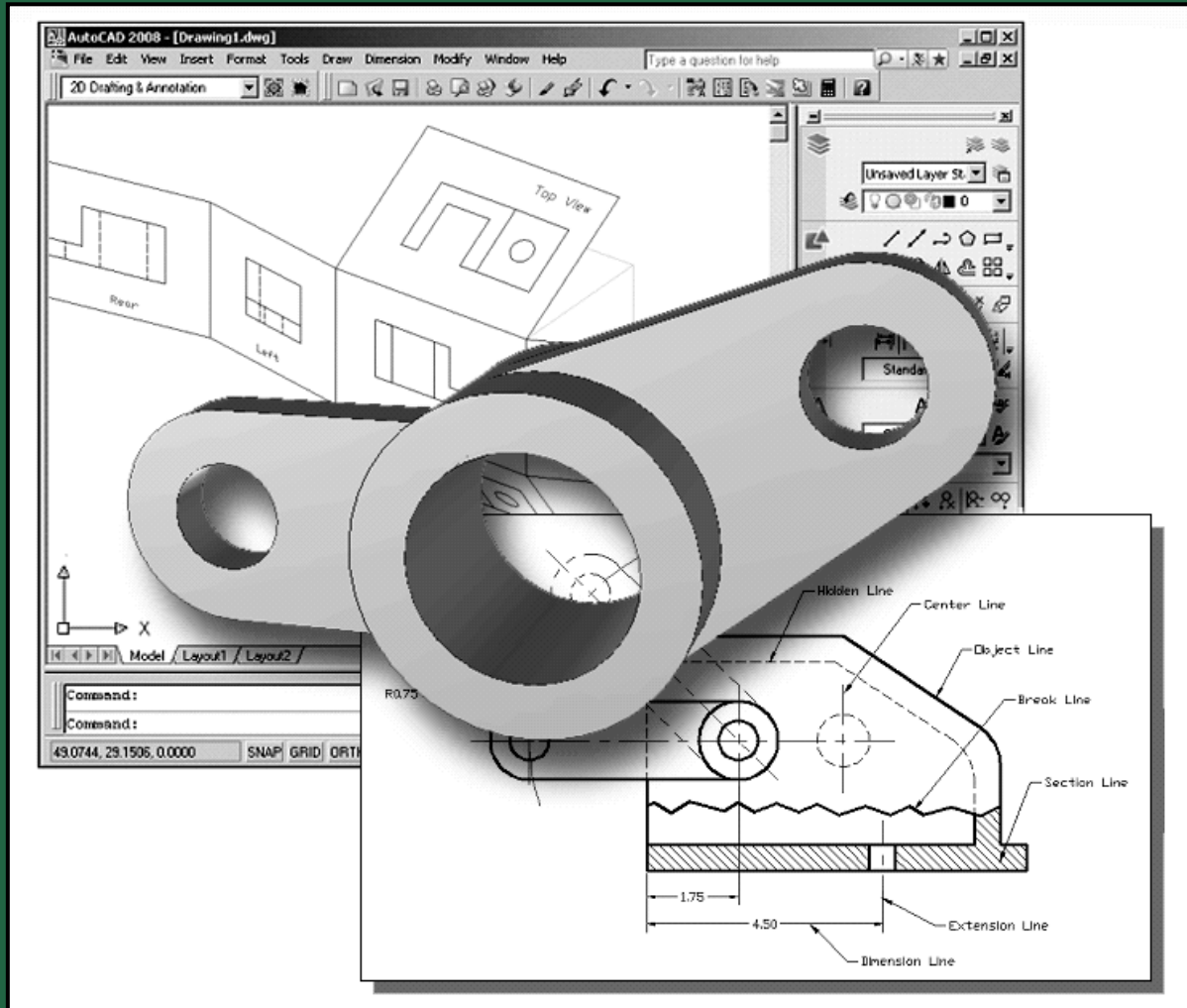

Randy H. Shih
Oregon Institute of Technology

SDC
PUBLICATIONS

Schroff Development Corporation

www.schroff.com
www.schroff-europe.com

Chapter 4 Orthographic Projection and Multiview Constructions

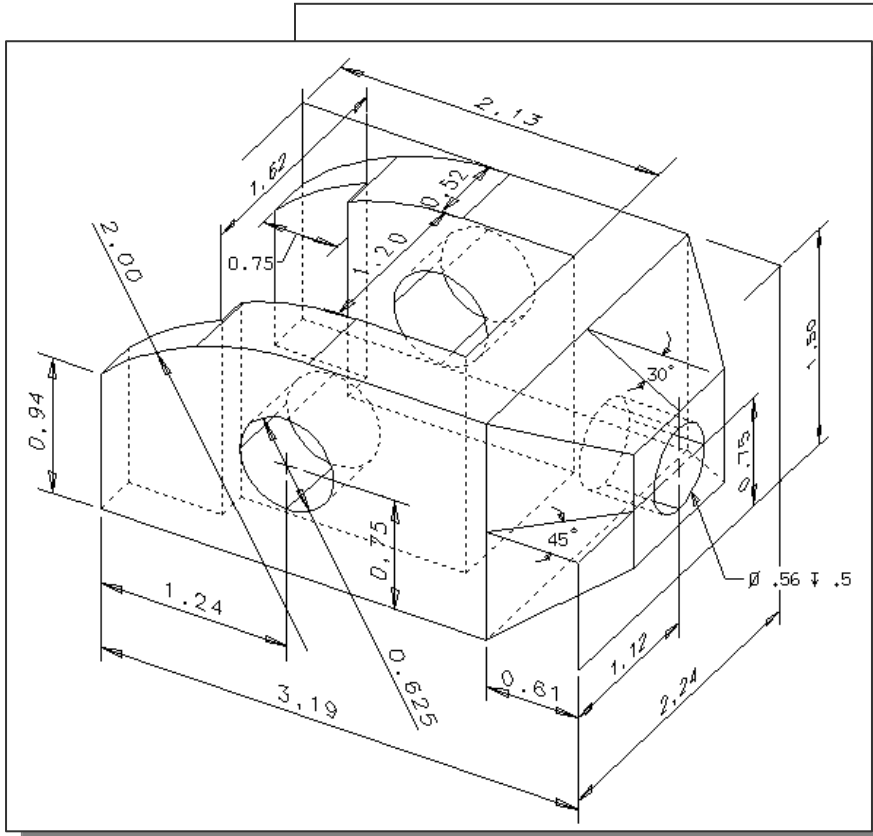

Learning Objectives

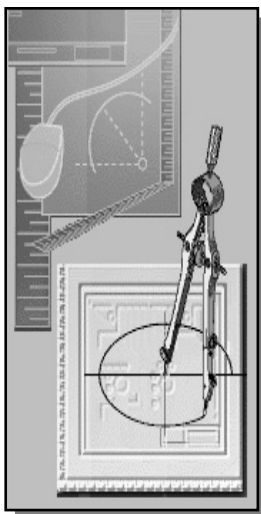

- ◆ Understand the Basic Orthographic projection principles.
- ◆ Be able to perform 1st and 3rd Angle projections.
- ◆ Use the CONSTRUCTION LINE command in AutoCAD to draw.
- ◆ Use the AutoCAD Running Object Snaps options.
- ◆ Use AutoCAD's *AutoSnap* and *AutoTrack* features.
- ◆ Using the Miter line method.

Introduction

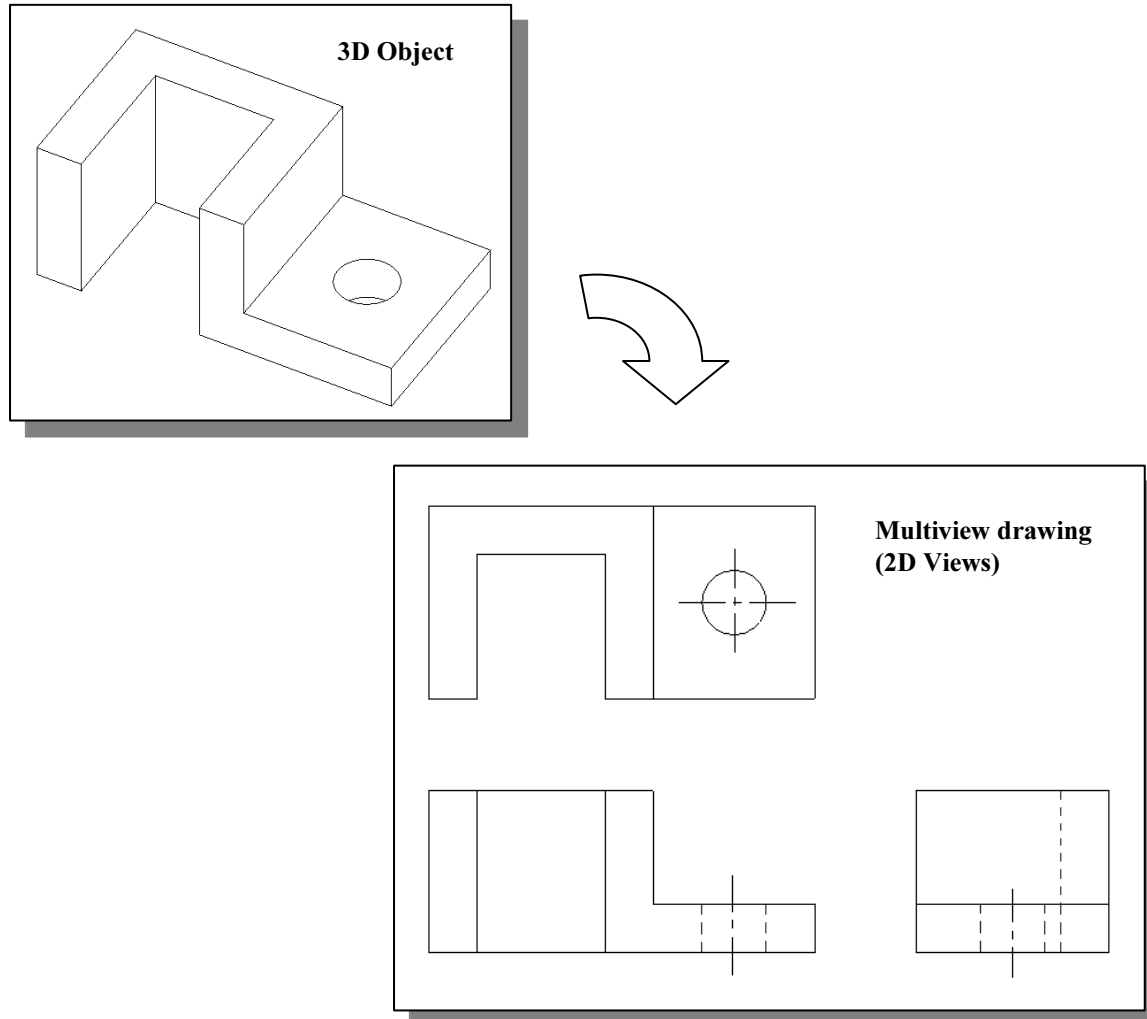

Most drawings produced and used in industry are ***multiview drawings***. Multiview drawings are used to provide accurate three-dimensional object information on two-dimensional media, a means of communicating all of the information necessary to transform an idea or concept into reality. The standards and conventions of multiview drawings have been developed over many years, which equip us with a universally understood method of communication.

Multiview drawings usually require several orthographic projections to define the shape of a three-dimensional object. Each orthographic view is a two-dimensional drawing showing only two of the three dimensions of the three-dimensional object. Consequently, no individual view contains sufficient information to completely define the shape of the three-dimensional object. All orthographic views must be looked at together to comprehend the shape of the three-dimensional object. The arrangement and relationship between the views are therefore very important in multiview drawings. Before taking a more in-depth look into the multiview drawings, we will first look at the concepts and principles of projections.

Basic Principles of Projection

To better understand the theory of projection, one must become familiar with the elements that are common to the principles of **projection**. First of all, the **POINT OF SIGHT** (aka, **STATION POINT**) is the position of the observer in relation to the object and the plane of projection. It is from this point that the view of the object is taken. Secondly, the observer views the features of the object through an imaginary **PLANE OF PROJECTION** (or **IMAGE PLANE**). Imagine yourself standing in front of a glass window, **IMAGE PLANE**, looking outward; the image of a house at a distance is sketched on to the glass which is a 2D view of a 3D house.

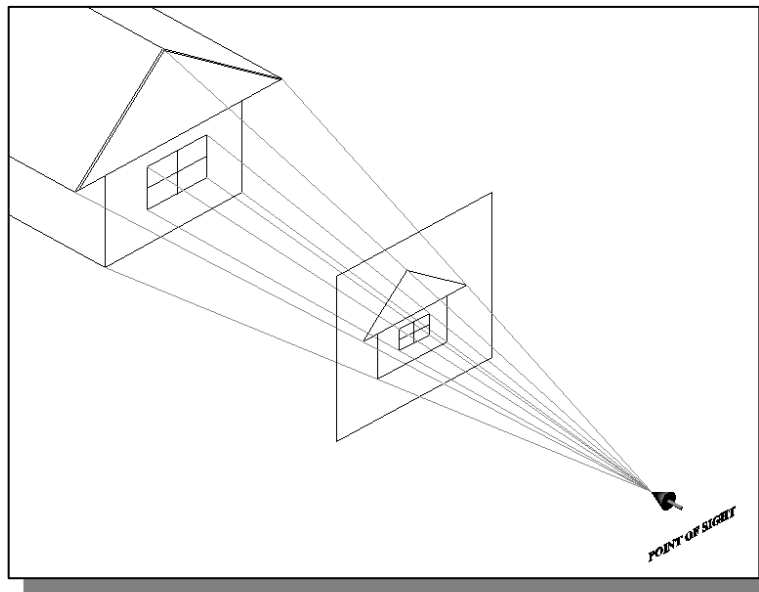

Orthographic Projection

The lines connecting from the *Point of Sight* to the 3D object are called the **Projection Lines** or **Lines of Sight**. Note that in the figure above, the projection lines are connected at the point of sight, and the projected 2D image is smaller than the actual size of the 3D object.

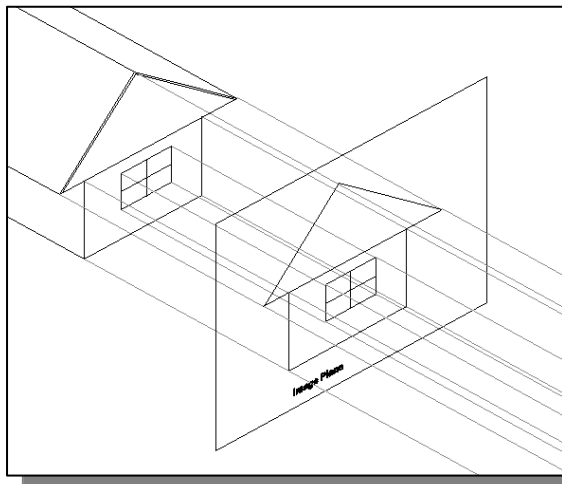

Now, if the *projection lines* are **parallel** to each other and the image plane is also **perpendicular** (*normal*) to the projection lines, the result is what is known as an **orthographic projection**. When the projection lines are parallel to each other, an accurate outline of the visible face of the object is obtained.

The term **orthographic** is derived from the word *orthos* meaning **perpendicular** or **90°**.

In *Engineering Graphics*, the projection of one face of an object usually will not provide an overall description of the object; other planes of projection must be used. To create the necessary 2D views, the *point of sight* is changed to project different views of the same object; hence, each view is from a different point of sight. If the point of sight is moved to the front of the object, this will result in the front view of the object. And then move the point of sight to the top of the object and looking down at the top, and then move to the right side of the object, as the case may be. Each additional view requires a new point of sight.

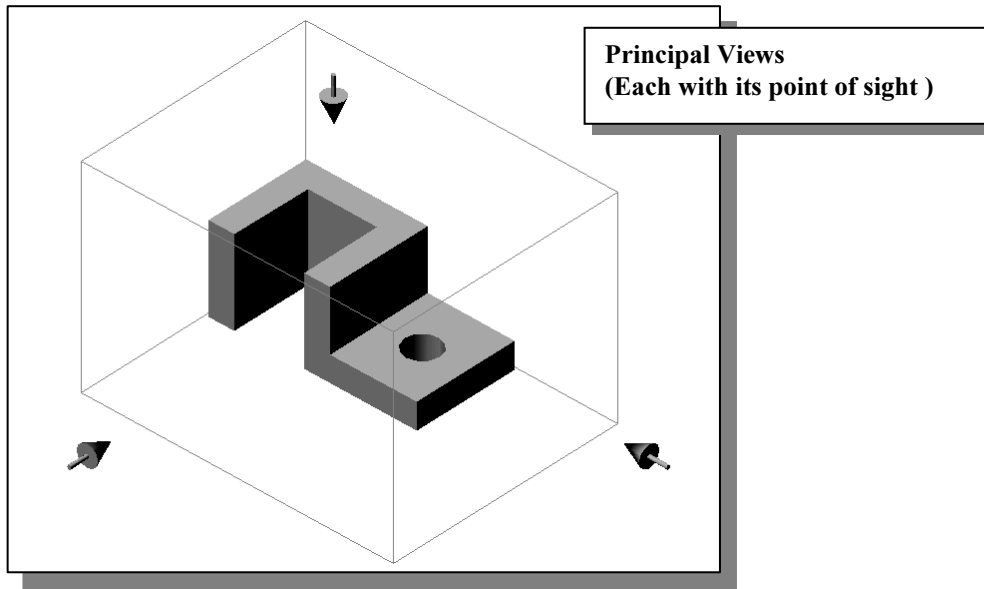

Multiview Orthographic Projection

In creating multiview orthographic projection, different systems of projection can be used to create the necessary views to fully describe the 3D object. In the figure below, two perpendicular planes are established to form the image planes for a multiview orthographic projection.

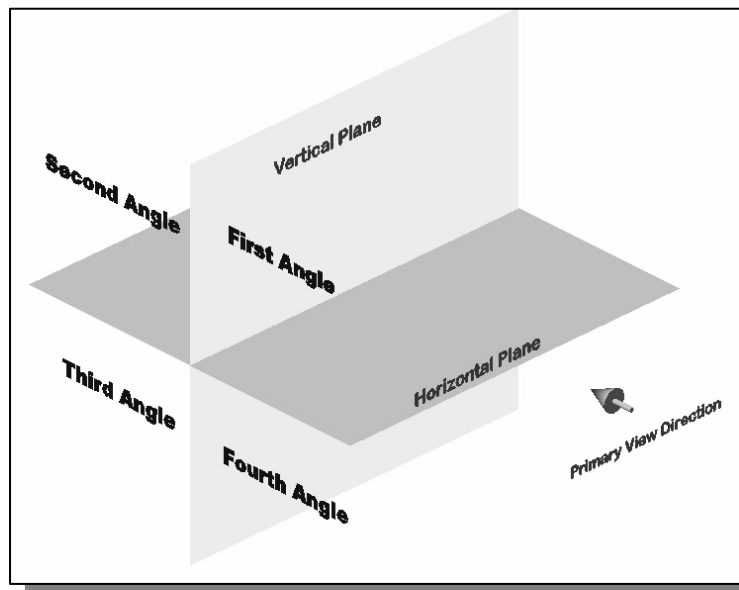

The angles formed between the horizontal and the vertical planes are called the **first, second, third, and fourth angles**, as indicated in the figure. For engineering drawings, both **first angle projection** and **third angle projection** are commonly used.

FIRST-ANGLE PROJECTION

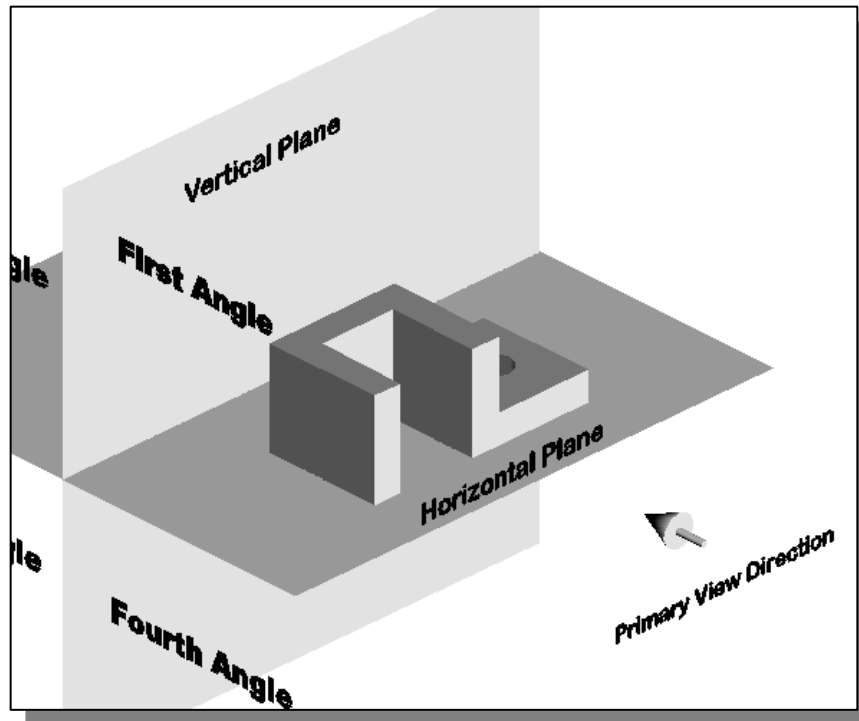

- ❖ In first-angle projection, the object is placed in **front** of the image planes. And the views are formed by projecting to the image plane located at the back.

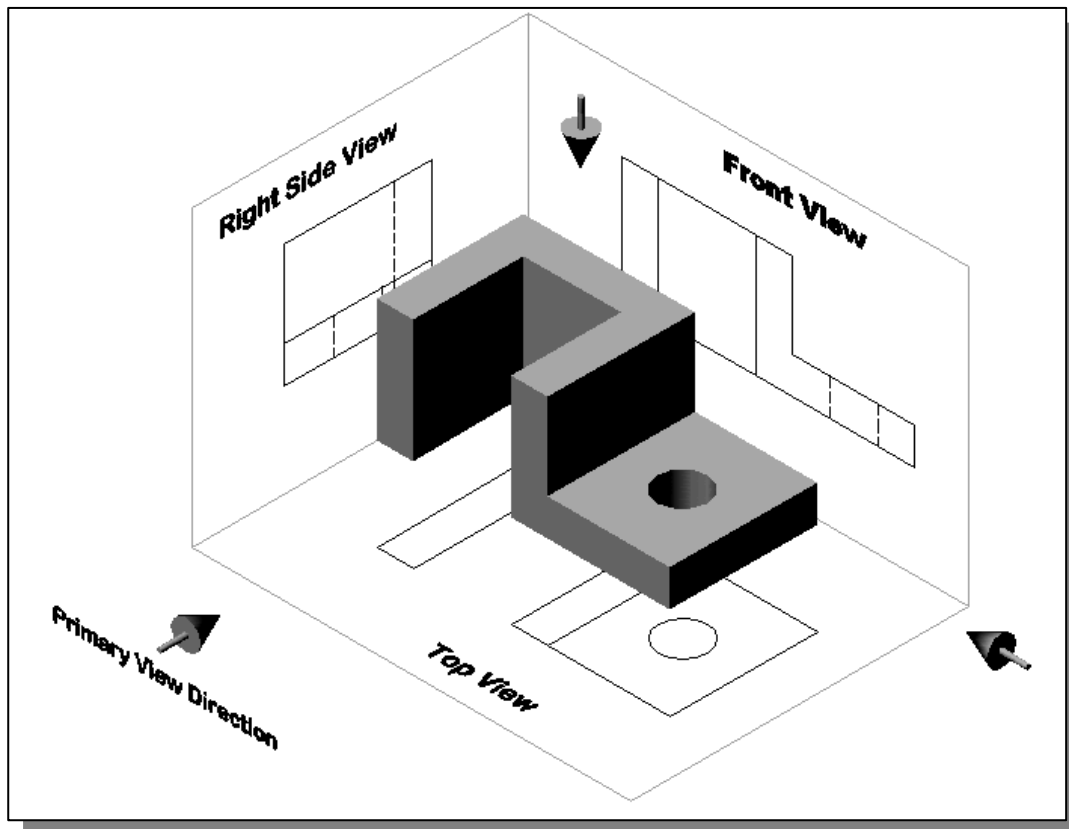

Rotation of the Horizontal and Profile planes

- ❖ In order to draw all three views of the object on the same plane, the horizontal (Top View) and profile (Right Side view) are rotated into the same plane as the primary image plane (Front View).

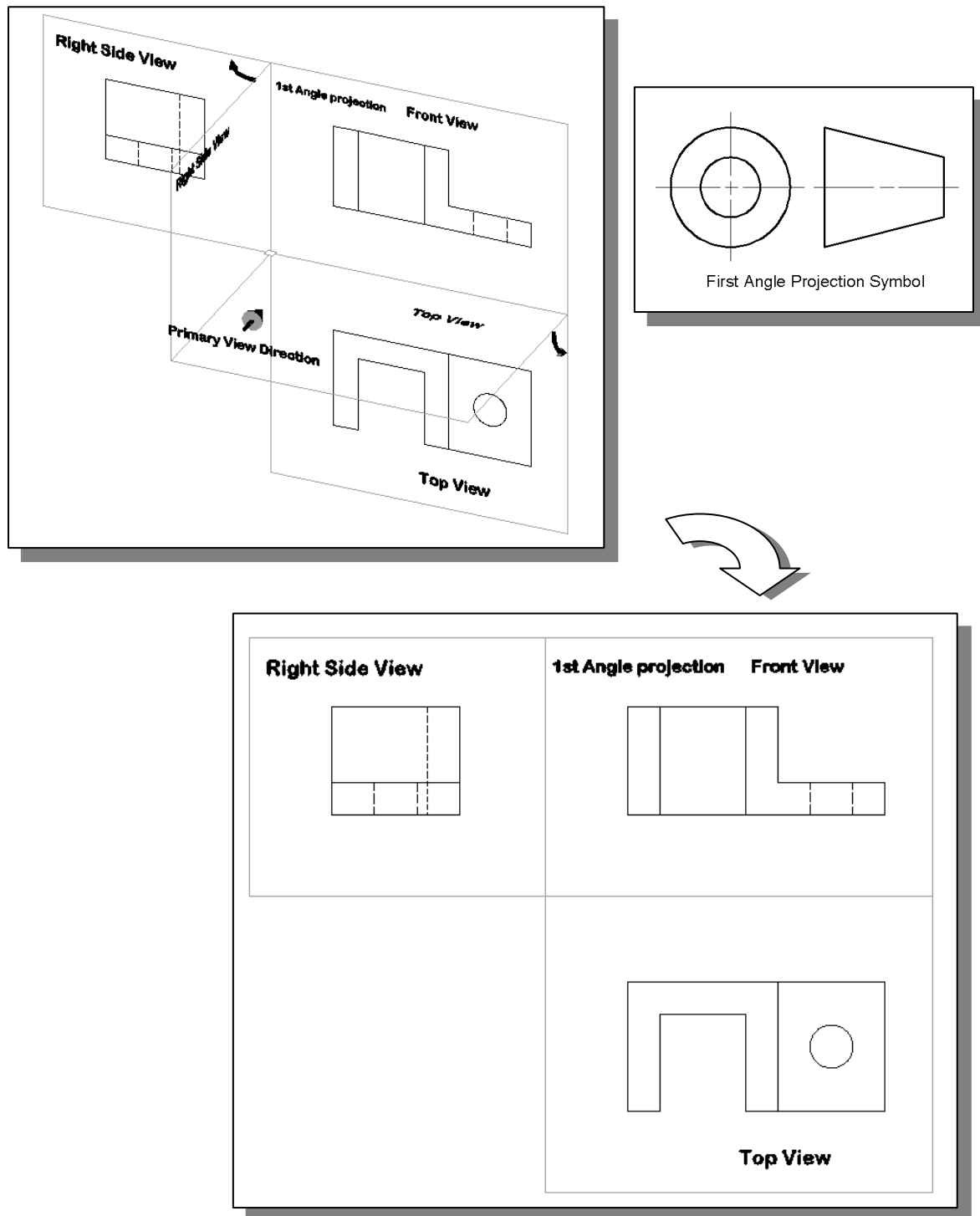

Getting the 3D Adjuster Model through the Internet

- AutoCAD® 2008 allows us to share files and resources through the Internet. Drawings can be placed and opened to an Internet location, insert blocks by dragging drawings from a web site, and insert hyperlinks in drawings so that others can access related documents. Note that to use the AutoCAD® 2008 Internet features, *Microsoft Internet Explorer 6.0* (or a later version) and Internet or Intranet connections are required.

We will illustrate the procedure to open an AutoCAD file from the Internet by *Uniform Resource Locator (URL)*.

1. Select the **AutoCAD 2008** option on the *Program* menu or select the **AutoCAD 2008** icon on the *Desktop*.
2. In the AutoCAD *Startup* dialog box, select **Open a Drawing** with a single click of the left-mouse-button.



3. Click **Browse** to open the *Select File* dialog box.

4. In the *Select File* dialog box, enter **<http://www.sdcACAD.com/acad2008/Adjuster1stAngle.dwg>** as shown in the figure below.

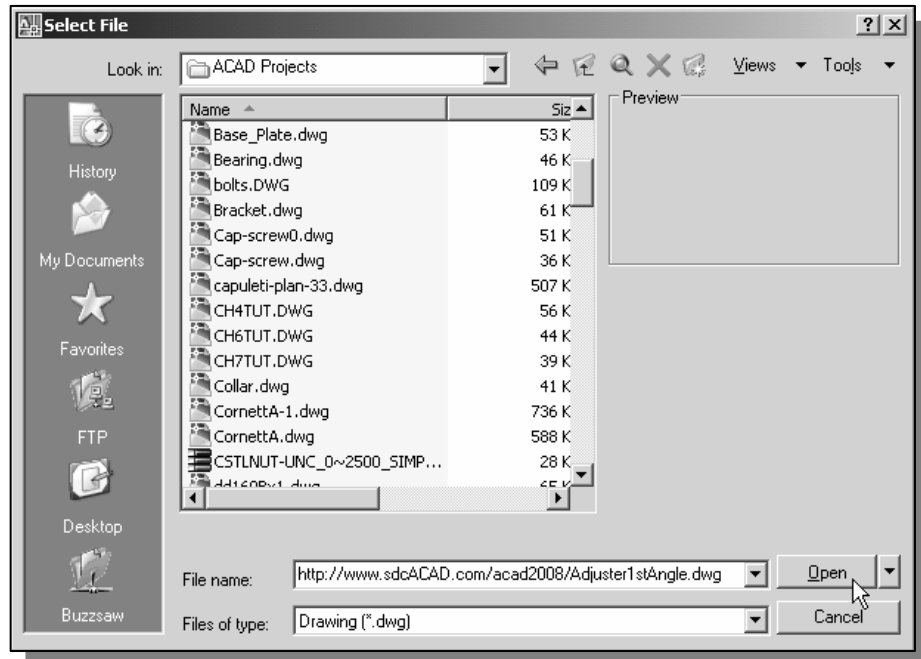

5. Click the **Open** icon and the file is downloaded from the www.sdcACAD.com web site to the local computer.

- The URL entered must be of the *Hypertext Transfer Protocol (http://)* and the complete filename must be entered including the filename extension (.dwg or .dwt).

Dynamic Rotation – 3D Orbit

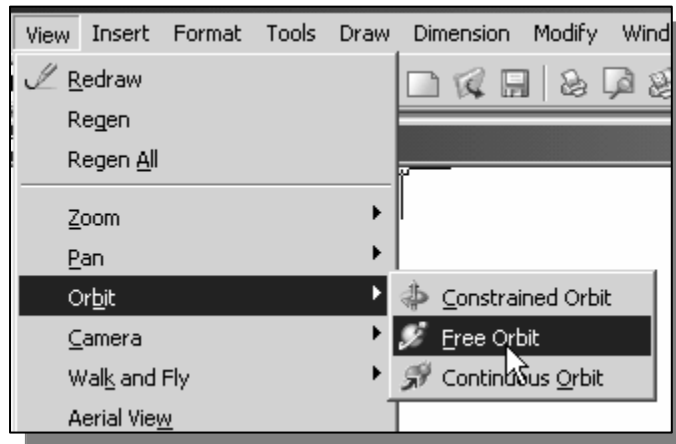

1. Select **3D Orbit** in the *View* pull-down menu.
[View] → [Orbit] → [Free Orbit]

- ❖ The Free-Orbit view displays an *arcball*, which is a circle, divided into four quadrants by smaller circles. Free-Orbit enables us to manipulate the view of 3D objects by clicking and dragging with the left-mouse-button.

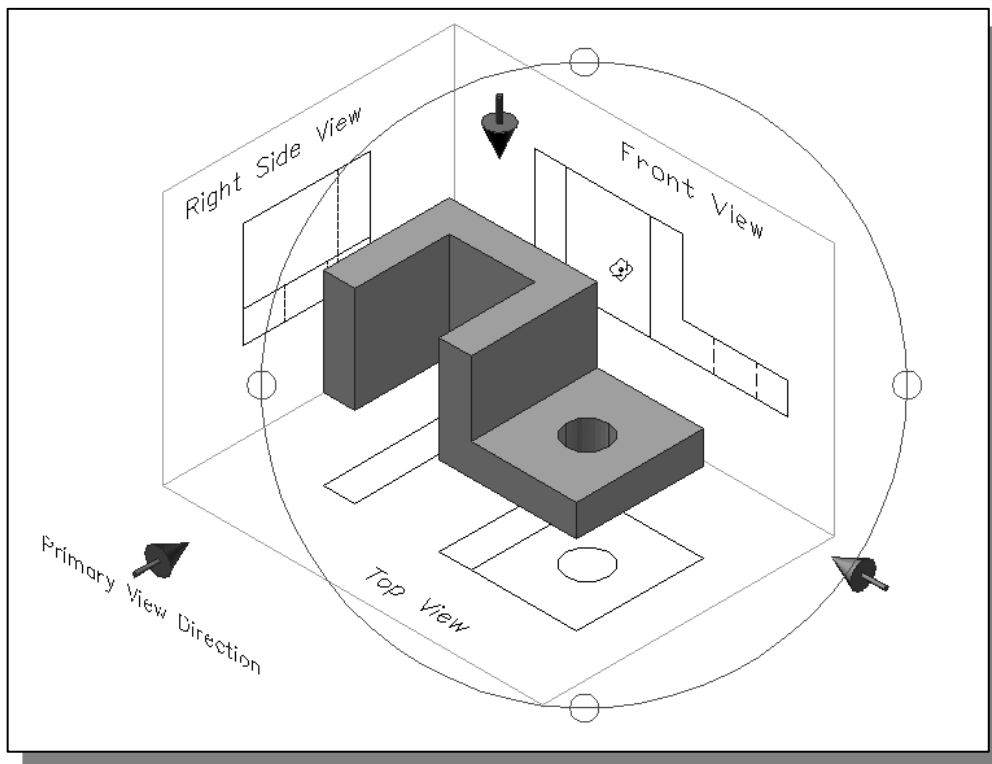

2. Inside the *arcball*, press down the left-mouse-button and drag it up and down to rotate about the screen X-axis. Dragging the mouse left and right will rotate about the screen Y-axis.
3. On your own, use the real-time dynamic rotation feature of the Free Orbit command and examine the relations of the 2D views, projection planes and the 3D object.

Third-Angle Projection

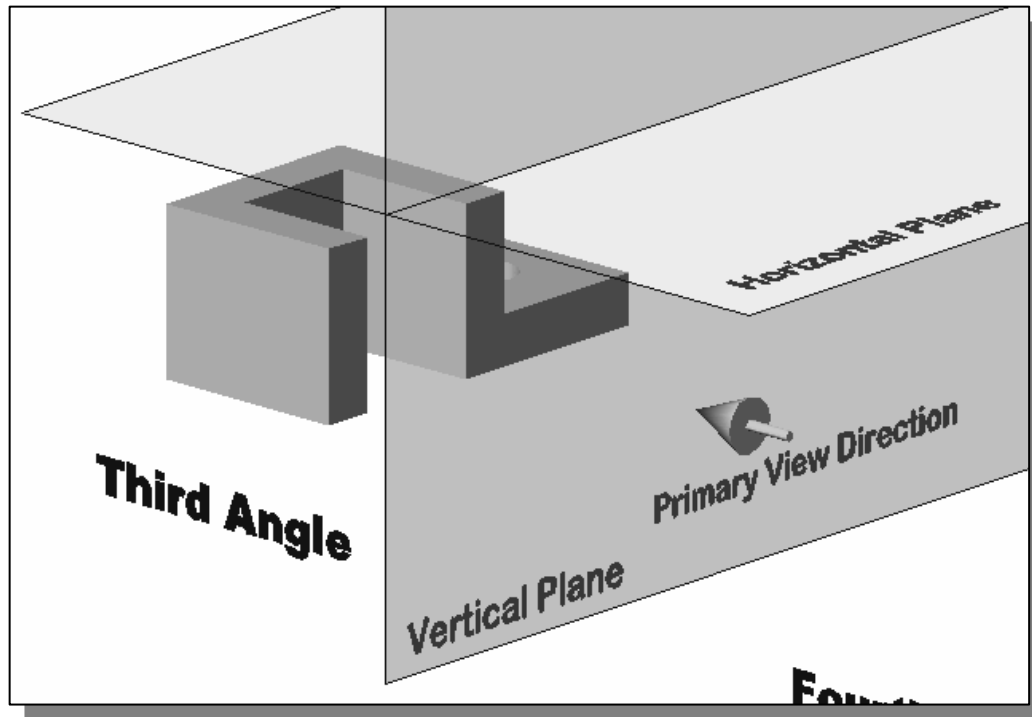

- ❖ In third-angle projection, the image planes are placed in between the object and the observer. And the views are formed by projecting to the image plane located in front of the object.

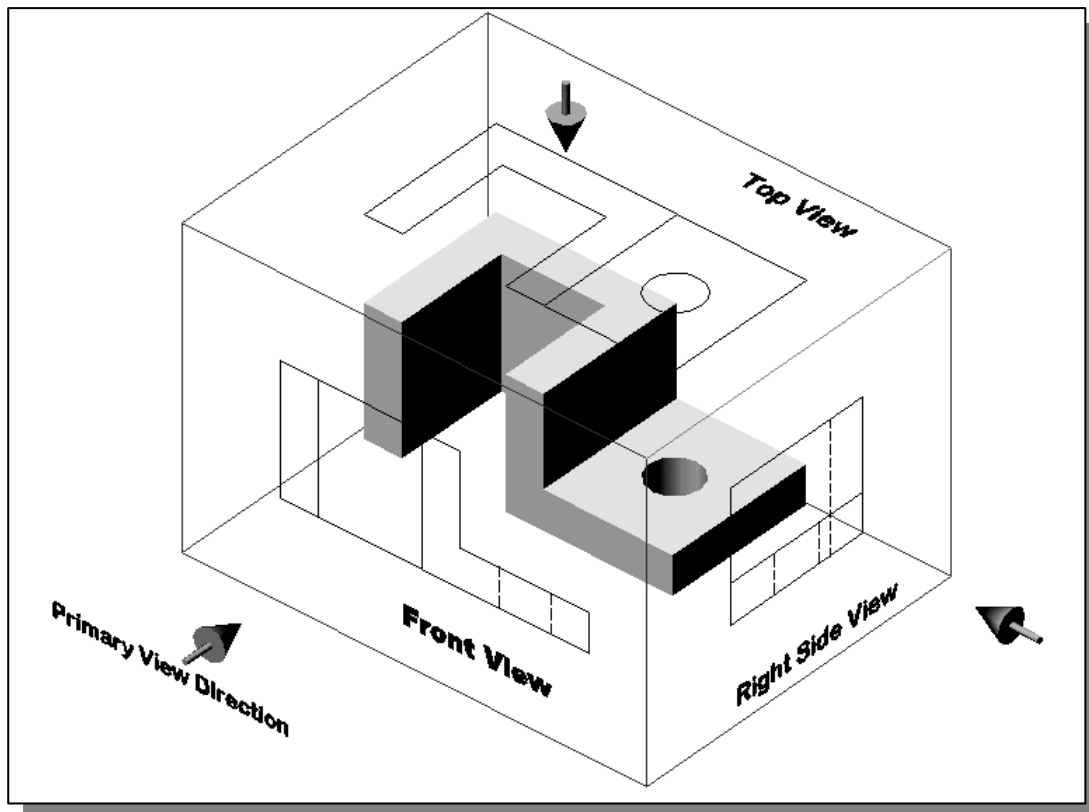

Rotation of the Horizontal and Profile Planes

- ❖ In order to draw all three views of the object on the same plane, the horizontal (Top View) and profile (Right Side View) are rotated into the same plane as the primary image plane (Front View).

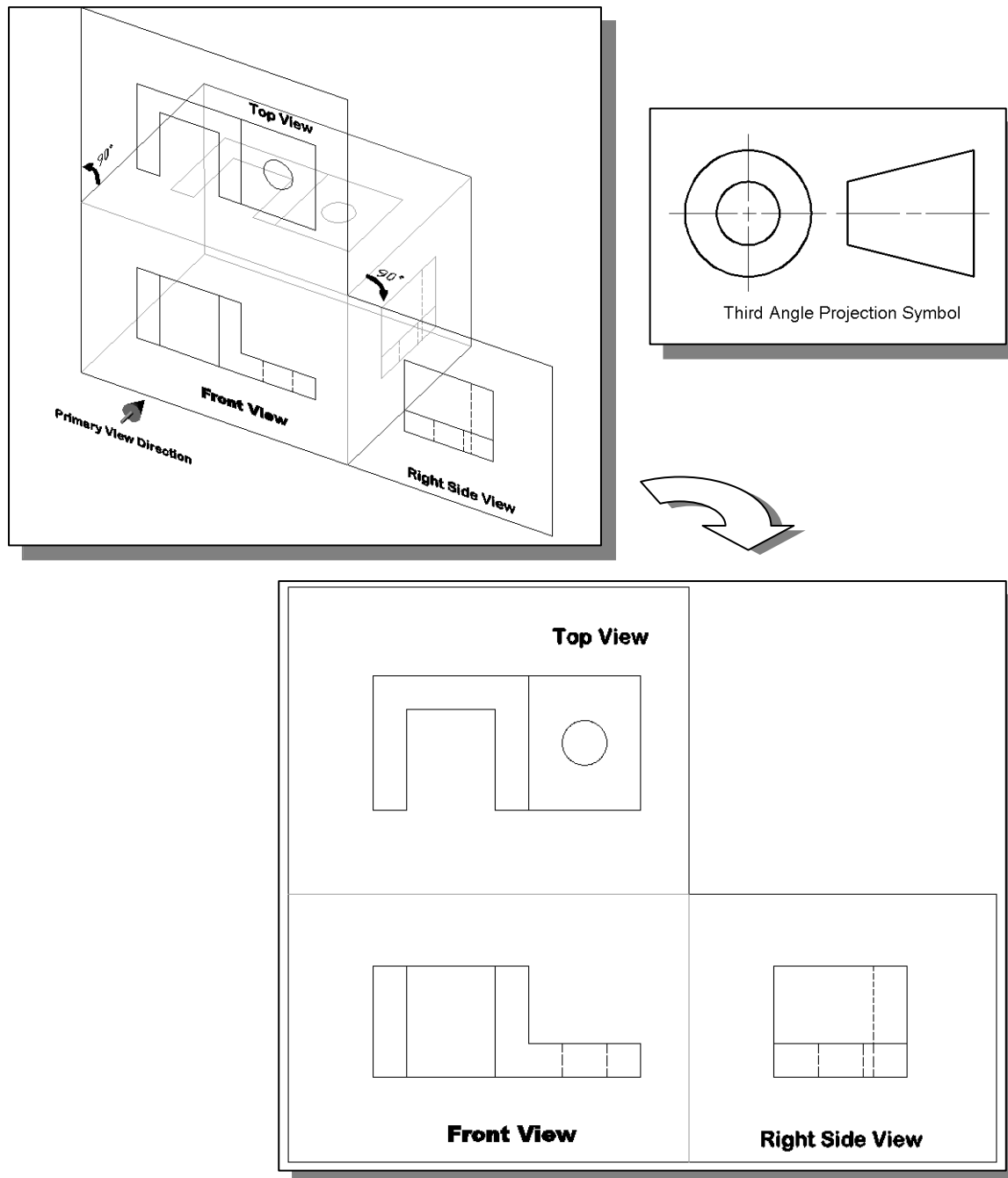

- Using the Internet Explorer, open the following **avi** file to view the rotation of the projection planes:
<http://www.sdcACAD.com/acad2008/AdjusterRTOP.avi>

Examining the 3rd Angle Projection

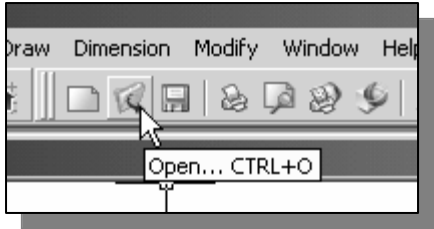

1. Click the **Open** icon in the *Standard* toolbar area as shown.

2. In the *Select File* dialog box, enter the following file name:
http://www.sdcACAD.com/acad2008/Adjuster3rdAngle.dwg

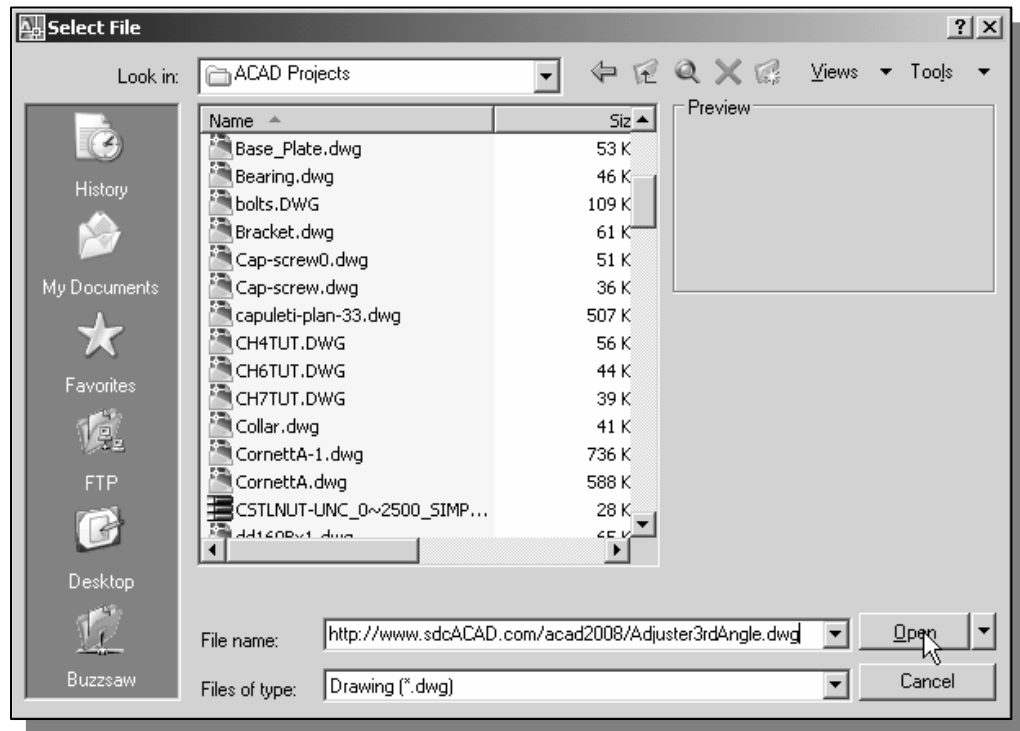

3. Click the **Open** icon and the ***Adjuster3rdAngle*** file is downloaded from the *www.sdcACAD.com* web site to the local computer.

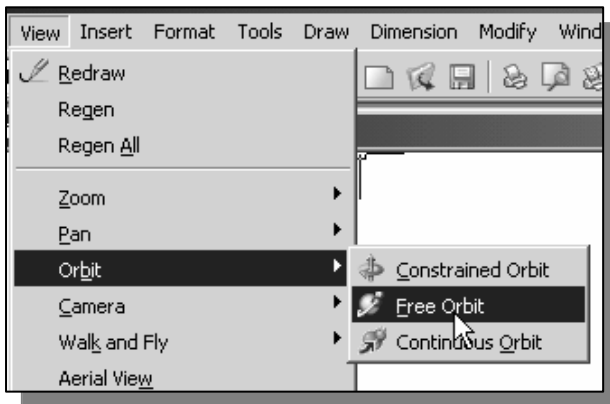

4. Select **3D Orbit** in the *View* pull-down menu.
[View] → [Orbit] → [Free Orbit]
5. On your own, examine the relations of the 2D views, projection planes and the 3D object.

The Glass Box and the Six Principal Views

Considering the third angle projection described in the previous section further, we find that the object can be entirely surrounded by a set of six planes, a glass box. On these planes, views can be obtained of the object as it is seen from the top, front, right side, left side, bottom, and rear.

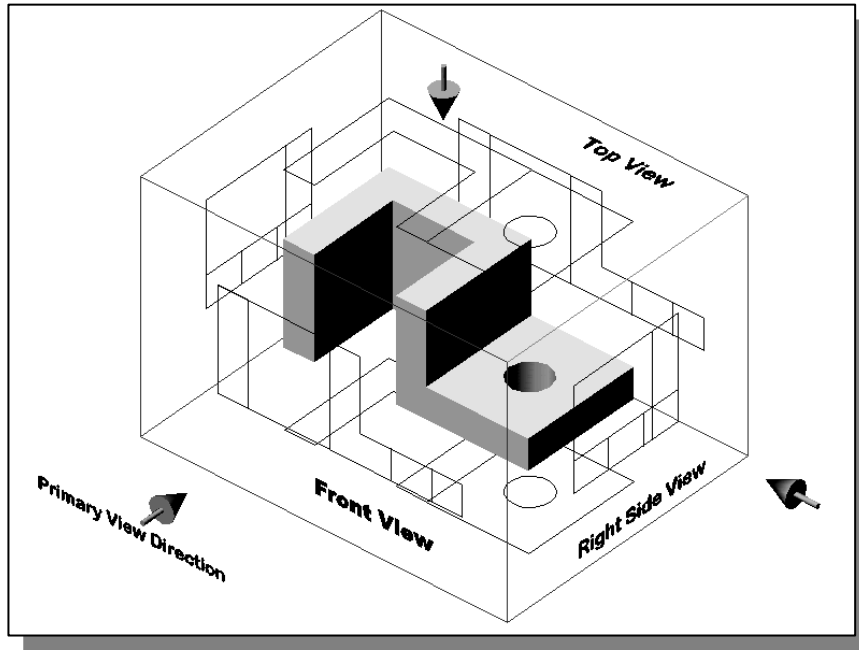

- ❖ Consider how the six sides of the glass box are being opened up onto one plane. The front is the primary plane, and the other sides are hinged and rotated into position.

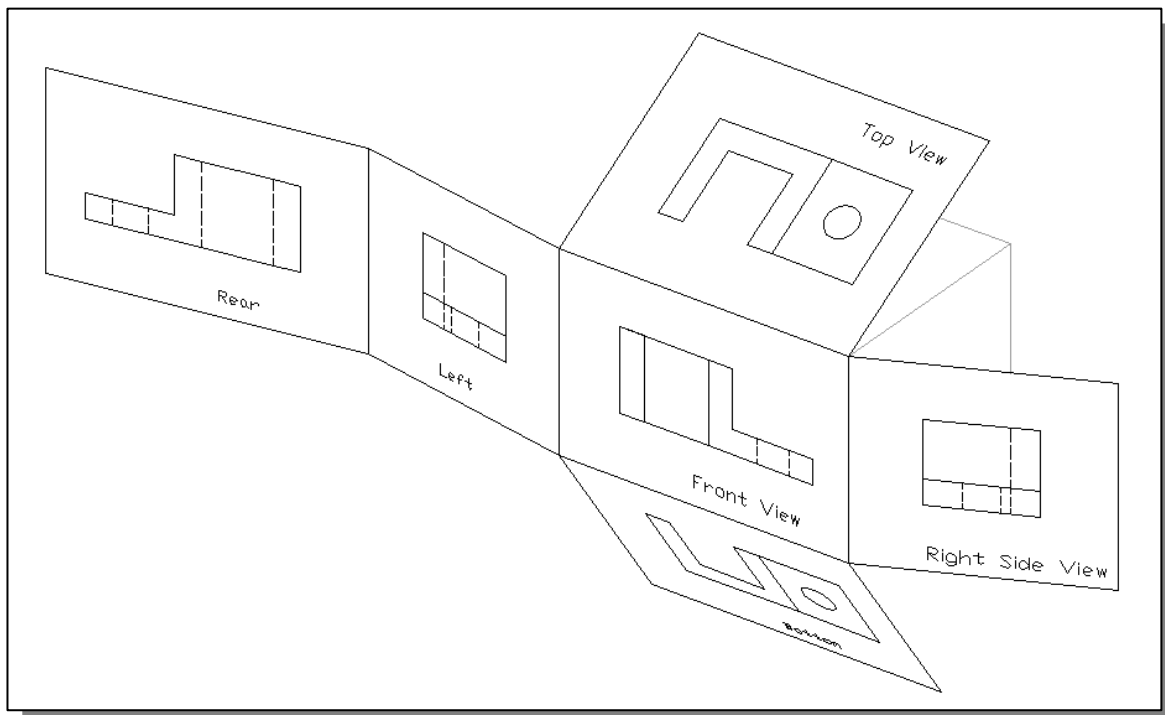

- ❖ In actual work there is rarely an occasion when all six principal views are needed on one drawing, but no matter how many are required, their relative positions need to be maintained. These six views are known as the **six principal views**. In performing orthographic projection, each of the 2D views shows only two of the three dimensions (**height, width, and depth**) of the 3D object.

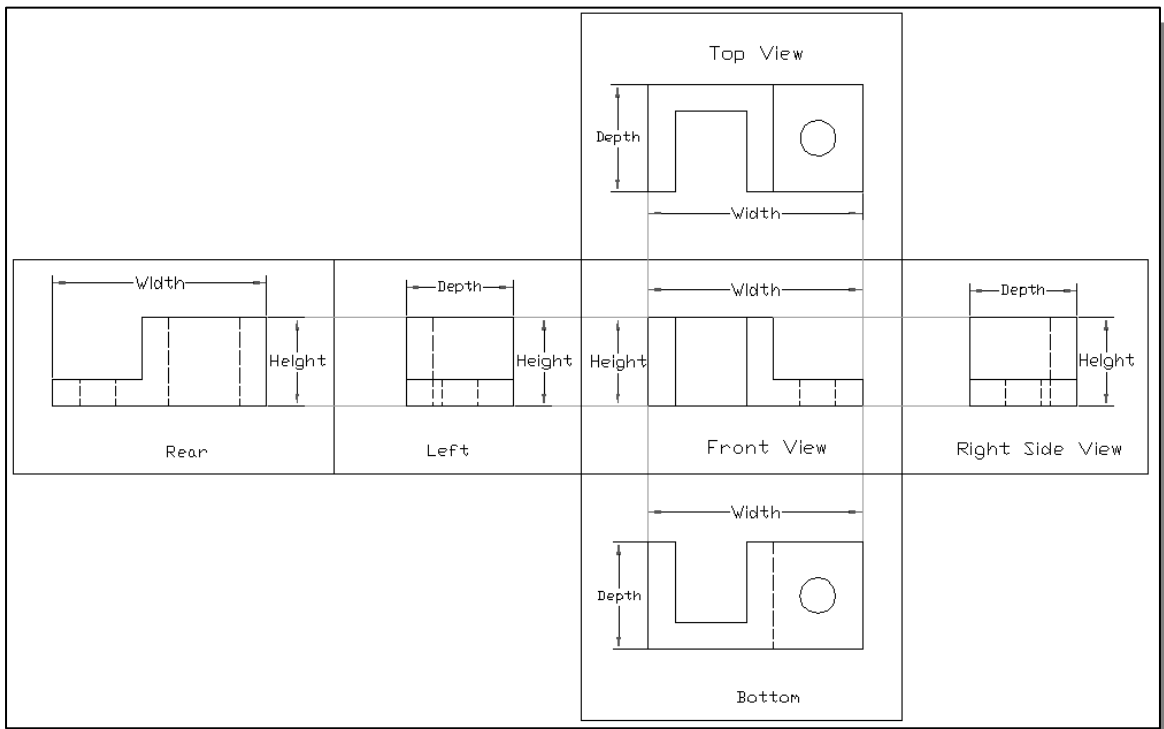
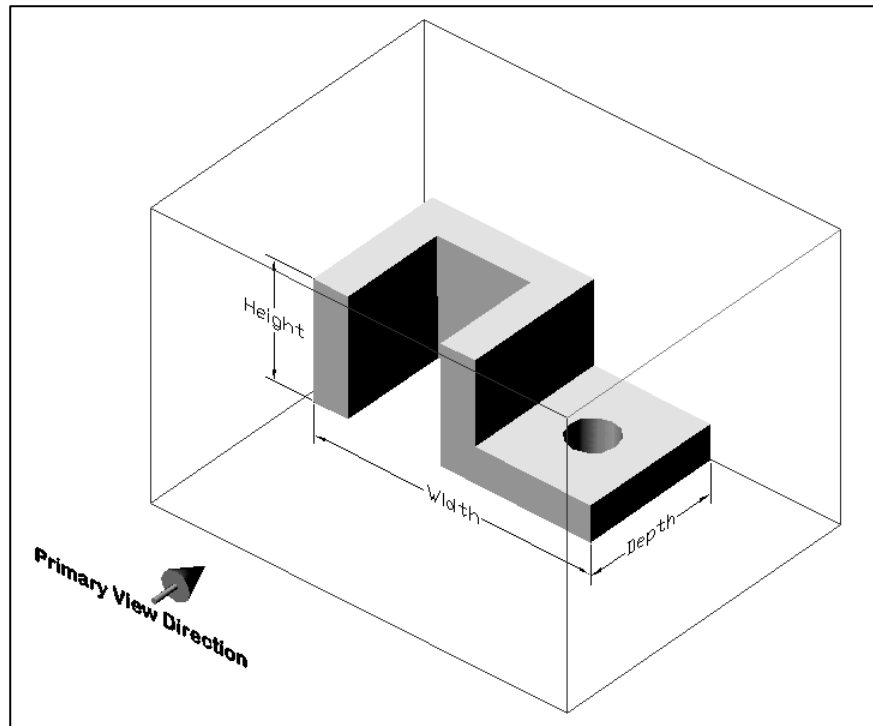

Examining the Glass Box Model

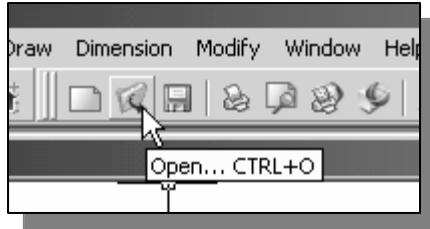

1. Click the **Open** icon in the *Standard* toolbar area as shown.

2. In the *Select File* dialog box, enter the following file name:
http://www.sdcACAD.com/acad2008/AdjusterGlassBox.dwg

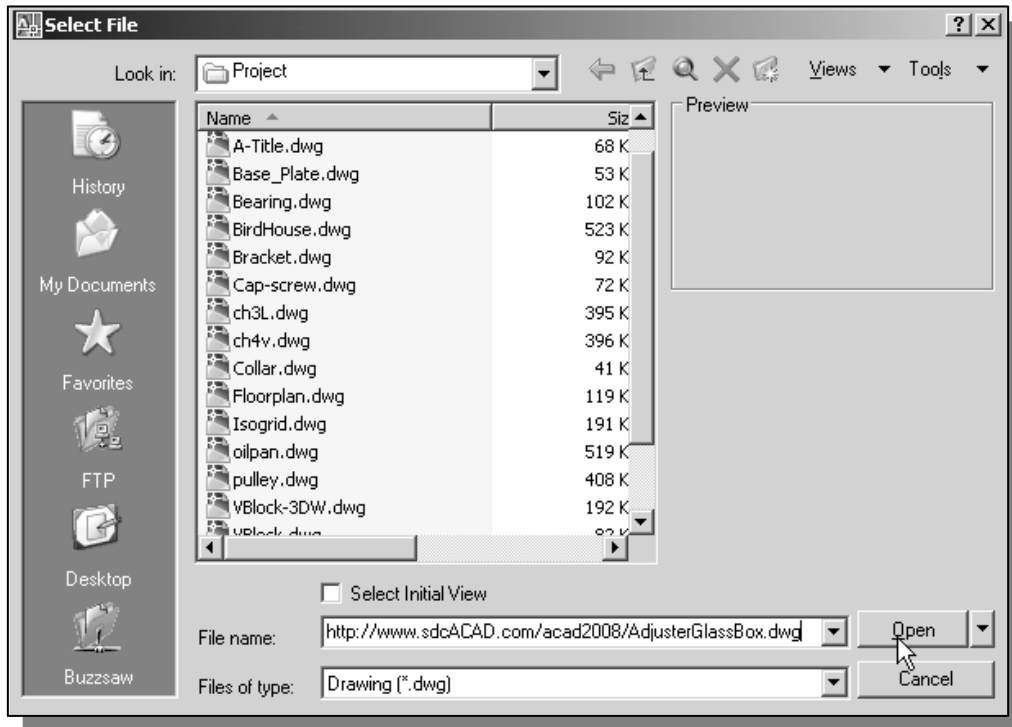

3. Click the **Open** icon and the **AdjusterGlassBox** file is downloaded from the www.sdcACAD.com web site to the local computer.

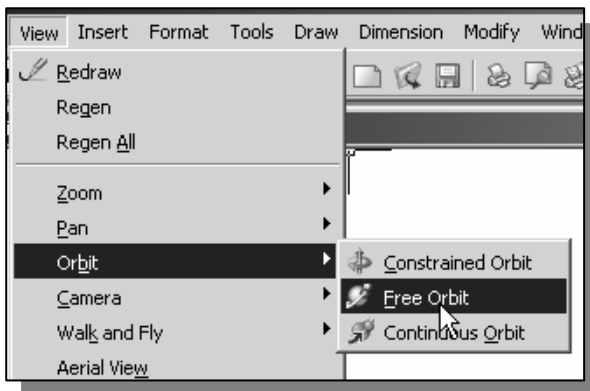

4. Select **3D Orbit** in the *View* pull-down menu.
[View] → [Orbit] → [Free Orbit]
5. On your own, examine the relations of the 2D views, projection planes and the 3D object.

Alphabet of Lines

In technical engineering drawings, each line has a definite meaning and is drawn in accordance to the line conventions as illustrated in the figure below. Two widths of lines are typically used on drawings; the thick line width should be 0.6 mm and the thin line width should be 0.3 mm.

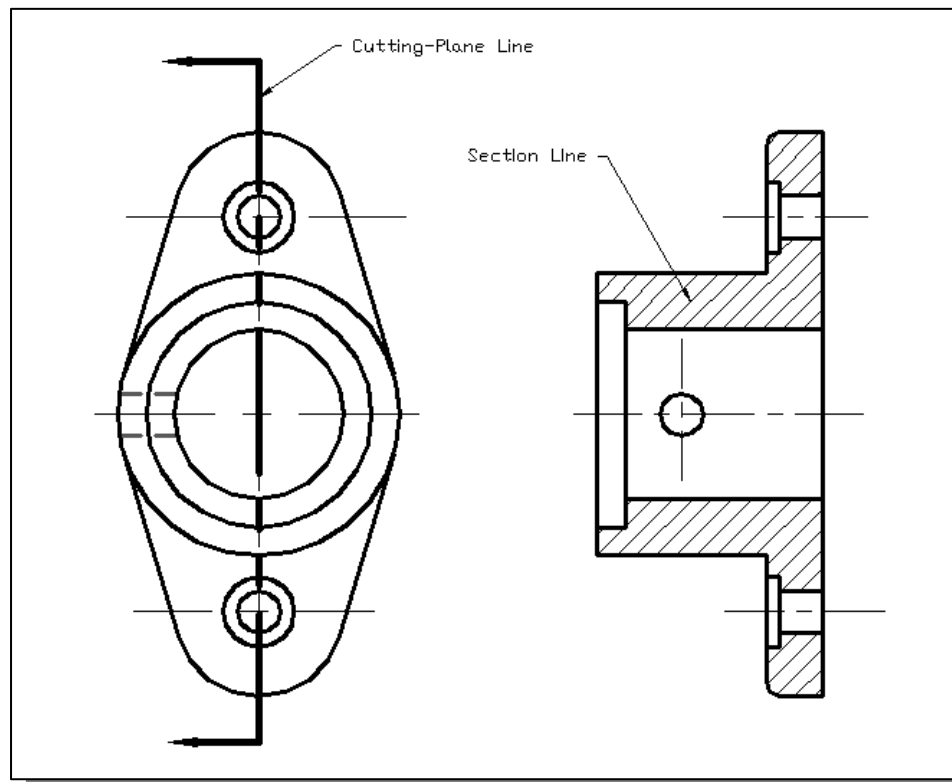
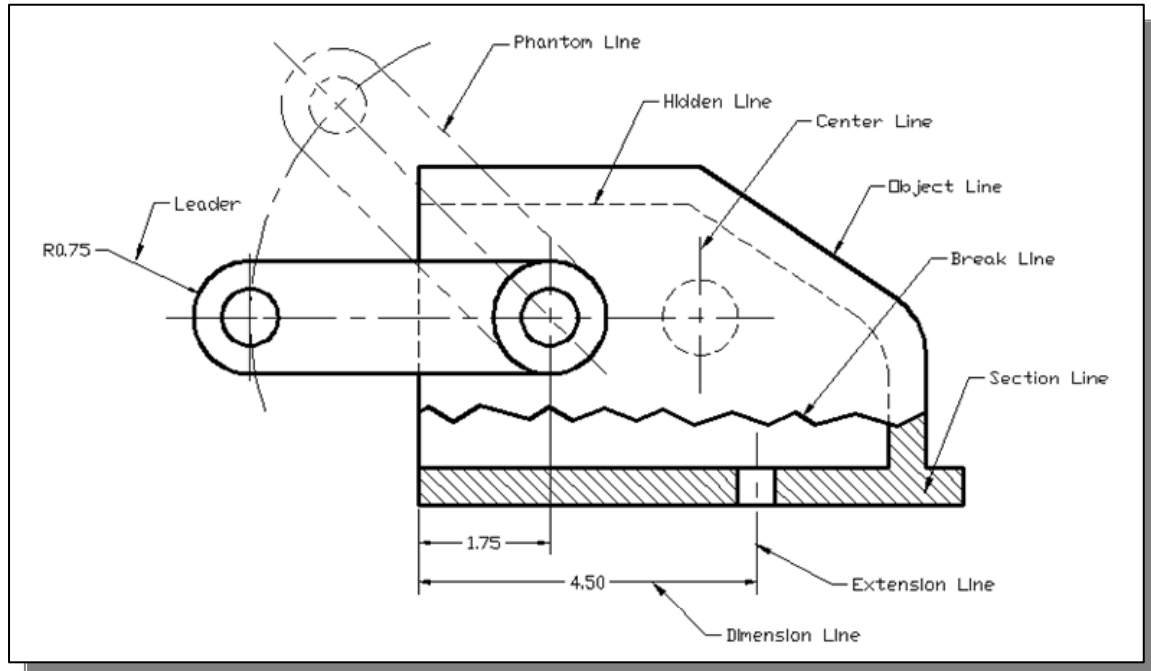

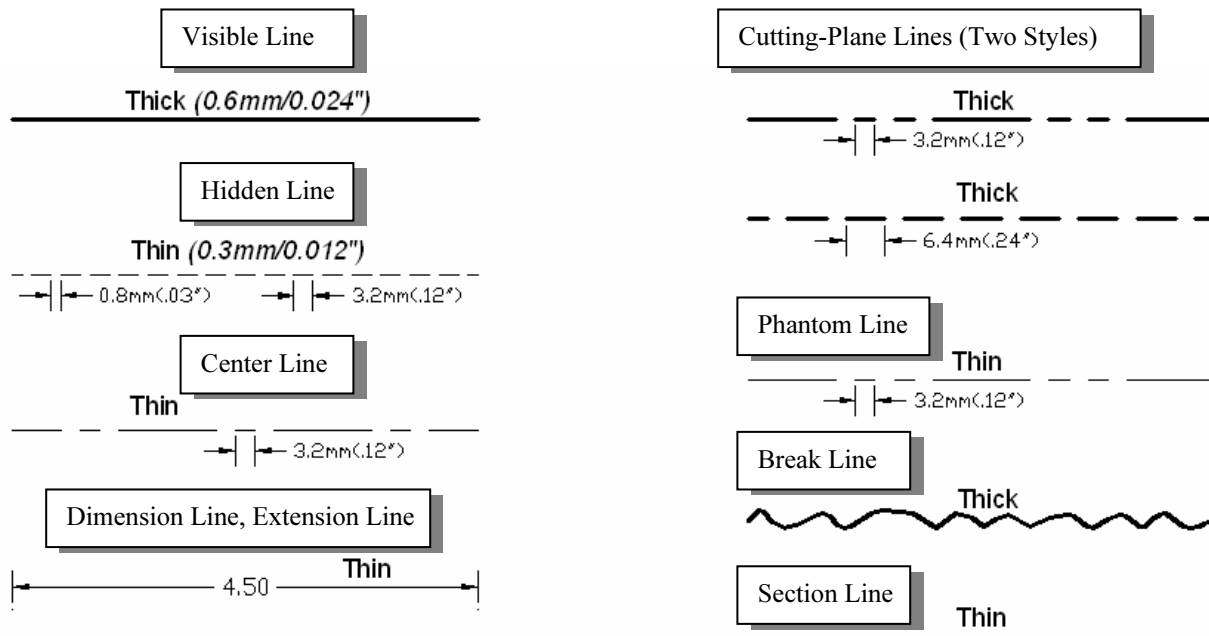

Visible Line Visible lines are used to represent visible edges and boundaries. The line weight is thick, 0.6mm/0.024").

Hidden Line Hidden lines are used to represent edges and boundaries that are not visible from the viewing direction. The line weight is thin, 0.3mm/0.012".

Center Line Center lines are used to represent axes of symmetry. The line weight is thick, 0.3mm/0.012".

Dimension Line, Extension Line and Leader Dimension lines are used to show the sizes and locations of objects. The line weight is thick, 0.3mm/0.012".

Cutting Plane Lines Cutting Plane lines are used to represent the location of an imaginary cut has been made, so that the interior of the object can be viewed. The line weight is thick, 0.6mm/0.024". (Note that two forms of linetype can be used.)

Phantom Line Phantom lines are used to represent imaginary features or objects, such as a rotated position of a part. The line weight is thin, 0.3mm/0.012".

Break Line Break lines are used to represent imaginary cut, so that the interior of the object can be viewed. . The line weight is thick, 0.6mm/0.024".

Section Line Section lines are used to represent the regions that have been cut with the *break lines* or *cutting plane lines*. The line weight is thin, 0.3mm/0.012".

Precedence of Lines

In multiview drawings, coincidence lines may exist within the same view. For example, hidden features may project lines to coincide with the visible object lines. And center lines may occur where there is a visible or hidden outline.

In creating a multiview drawing, the features of the design are to be represented, therefore object and hidden lines take precedence over all other lines. And since the visible outline is more important than hidden features, the visible object lines take precedence over hidden lines as shown in the figure below.

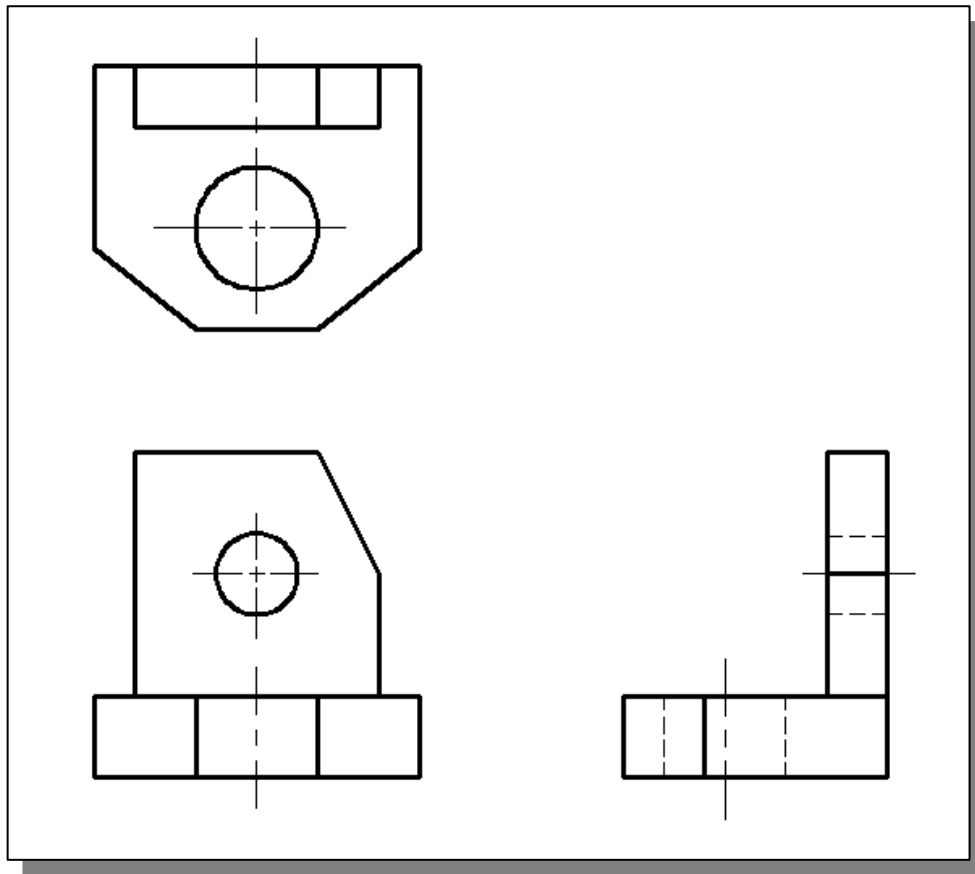

The following list gives the order of precedence of lines:

1. **Visible object lines**
2. **Hidden lines**
3. **Center line or cutting – plane line**
4. **Break lines**
5. **Dimension and extension lines**
6. **Crosshatch/section lines**

In the following sections, the general procedure of creating a 3rd angle three-view orthographic projection using AutoCAD is presented.

The *Locator* design

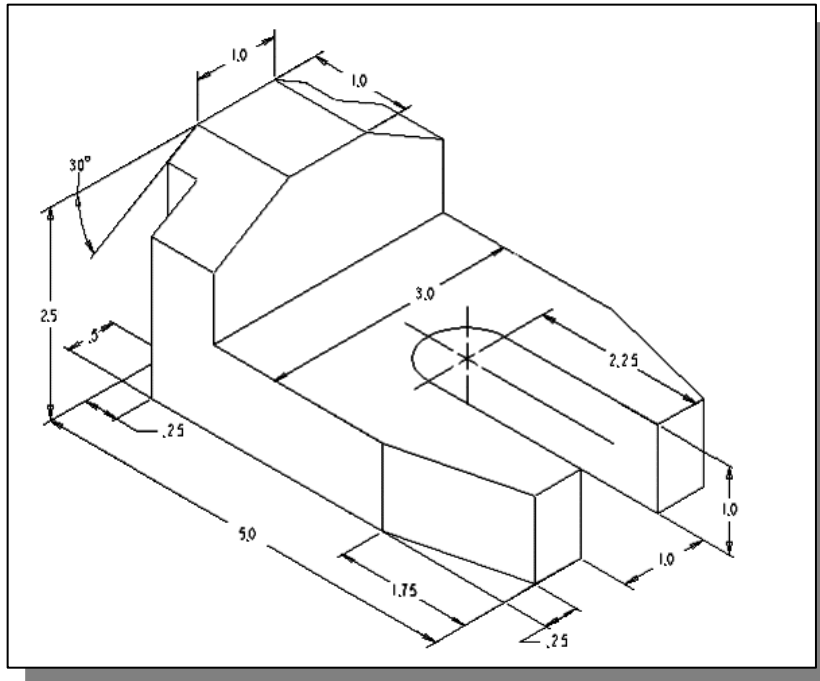

- Before going through the tutorial, make a rough sketch of a multiview drawing of the part. Based on your knowledge of **AutoCAD® 2008** so far, how would you arrange and construct these 2D views? Take a few minutes to consider these questions and do preliminary planning by sketching on a piece of paper. You are also encouraged to construct the orthographic views on your own prior to following through the tutorial. (Download the 3D *Locator* model by opening up the following the model at URL: <http://www.sdcACAD.com/acad2008/Locator.dwg>)

Starting Up AutoCAD® 2008

1. Select the **AutoCAD 2008** option on the *Program* menu or select the **AutoCAD 2008** icon on the *Desktop*.

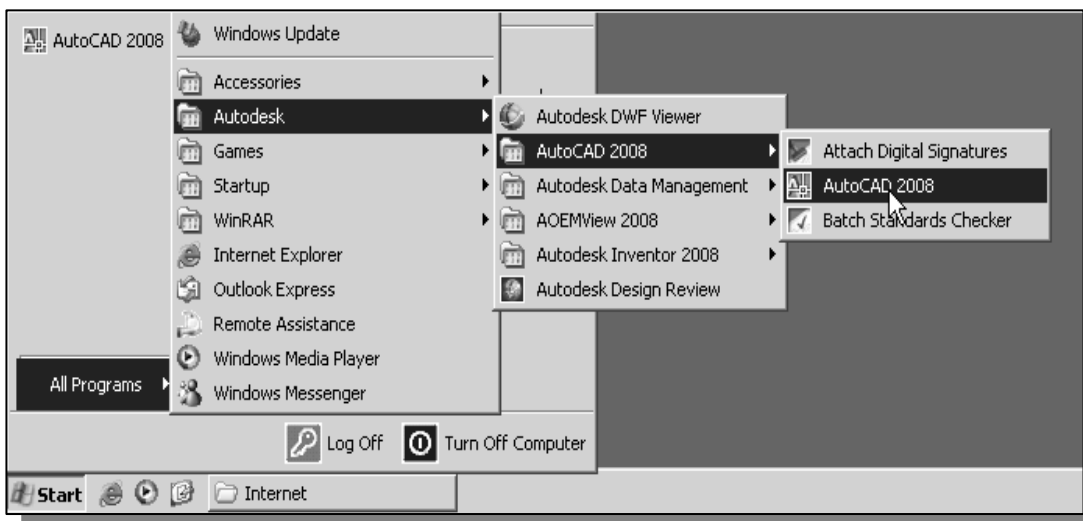

- In the *Startup* dialog box, select the **Start from Scratch** option with a single click of the left-mouse-button.

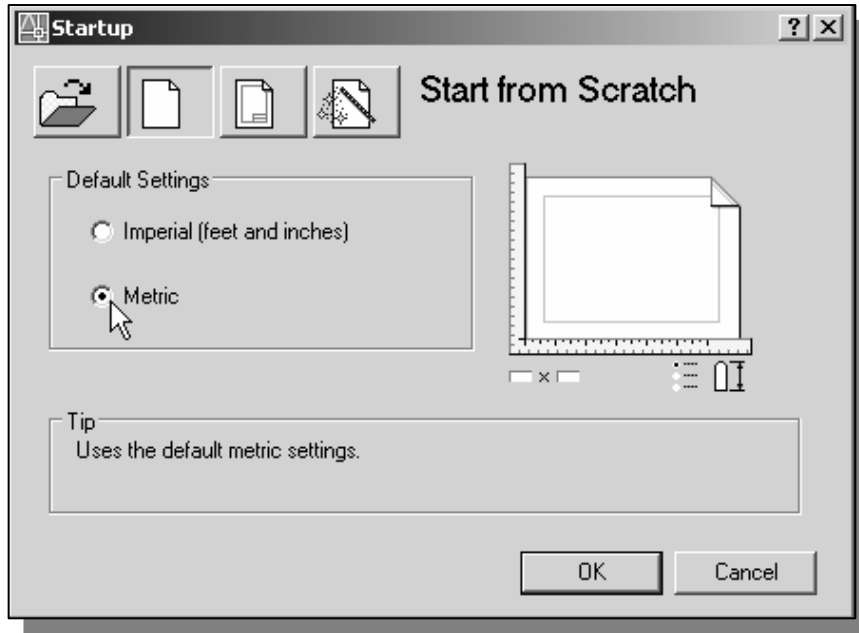

- In the *Default Settings* section, pick **Imperial** as the drawing units.
- Click **OK** to accept the settings and exit the *Startup* window.

GRID and SNAP Intervals Setup

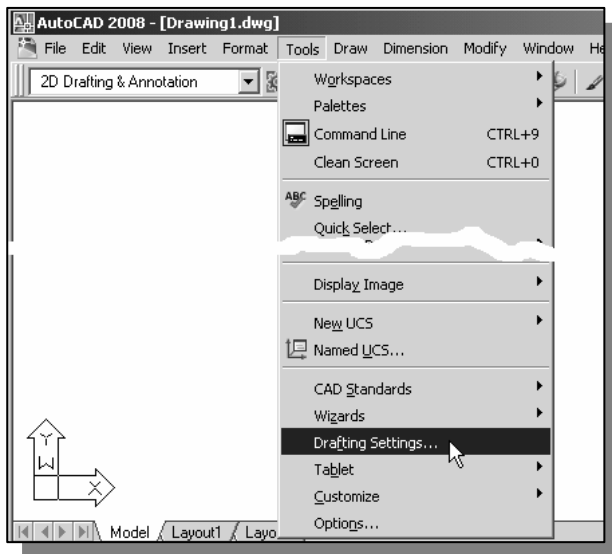

- In the pull-down menus, select: **[Tools] → [Drafting Settings]**
- In the *Drafting Settings* dialog box, select the **SNAP and GRID** tab if it is not the page on top.
- Change *Grid Spacing* to **0.5** for both X and Y directions.
- Also adjust the *Snap Spacing* to **0.5** for both X and Y directions.



- Pick **OK** to exit the *Drafting Settings* dialog box.

Layers Setup

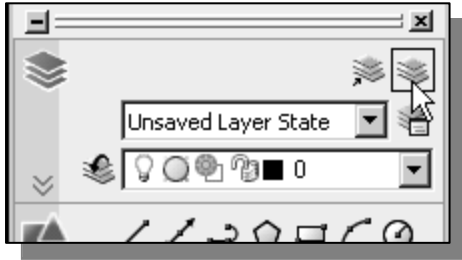

1. Pick **Layer Properties Manager** in the *Object Properties* toolbar.

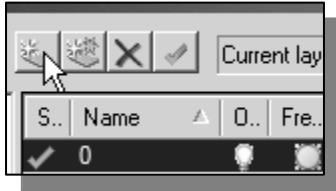

2. Click on the **New** icon to create new layers.

3. Create two **new** layers with the following settings:

<i>Layer</i>	<i>Color</i>	<i>Linetype</i>
Construction	White	Continuous
Object	Yellow	Continuous

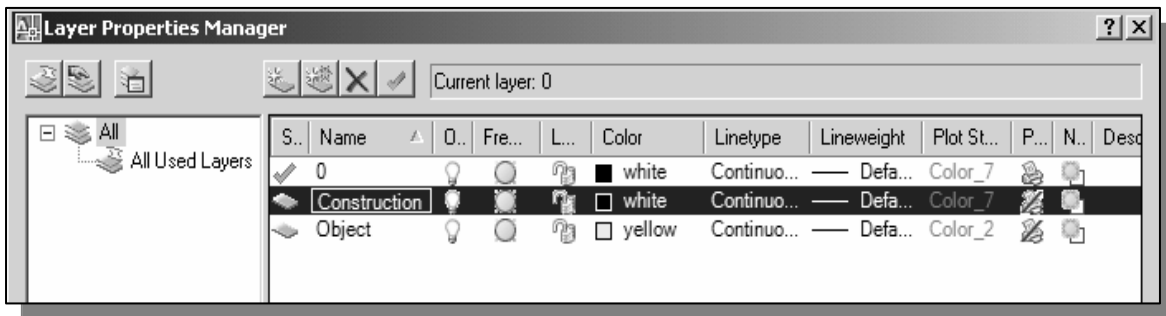

4. Highlight the layer **Construction** in the list of layers.

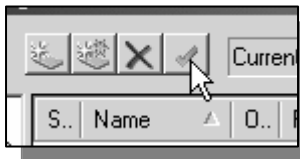

5. Click on the **Current** button to set layer **Construction** as the *Current Layer*.



6. Click on the **OK** button to accept the settings and exit the *Layer Properties Manager* dialog box.

7. In the *Status Bar* area, reset the option buttons so that only **SNAP**, **GRID**, and **MODEL** are switched **ON**.



Drawing Construction Lines

- ❖ *Construction lines* are lines that extend to infinity. Construction lines are usually used as references for creating other objects. We will also place the construction lines on the *Construction* layer so that the layer can later be frozen or turned off.

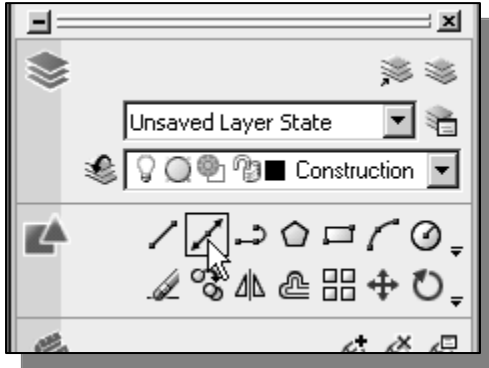

1. Select the **Construction Line** icon in the *Draw* toolbar. In the command prompt area, the message “*_xline Specify a point or [Hor/Ver/Ang/Bisect/Offset].*” is displayed.
 - To orient construction lines, we generally specify two points. Note that other orientation options are also available.
2. Select a location near the lower left corner of the graphics window. It is not necessary to align objects to the world coordinate origin. CAD systems provide us with many powerful tools to manipulate geometry. Our main goal is to use the CAD system as a flexible and powerful tool, and to be very efficient and effective with the systems.
3. Pick a location above the last point to create a **vertical construction line**.
4. Move the cursor toward the right of the first point and pick a location to create a **horizontal construction line**.
5. Inside the graphics window, **right-mouse-click** to end the Construction Line command.
6. In the *Status Bar* area, turn **OFF** the *SNAP* option.



Using the Offset command

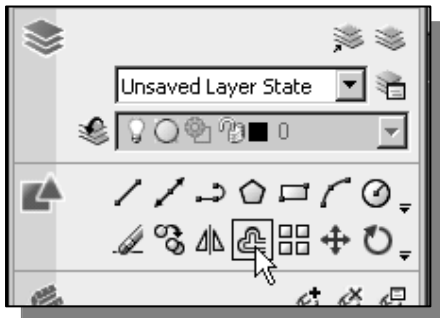

1. Select the **Offset** icon in the *Modify* toolbar. In the command prompt area, the message “*Specify offset distance or [Through/Erase/Layer].*” is displayed.
2. In the command prompt area, enter: **5.0 [ENTER]**.
3. In the command prompt area, the message “*Select object to offset or <exit>.*” is displayed. Pick the **vertical line** on the screen.

4. AutoCAD next asks us to identify the direction of the offset. Pick a location that is to the **right** of the vertical line.
5. Inside the graphics window, **right-mouse-click** to end the Offset command.

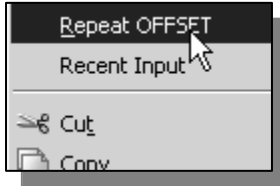

6. Hit the [SPACE BAR], or right-mouse-click inside the graphics window and select **Repeat Offset** in the popup list, to repeat the Offset command.

7. In the command prompt area, enter: **2.5 [ENTER]**.

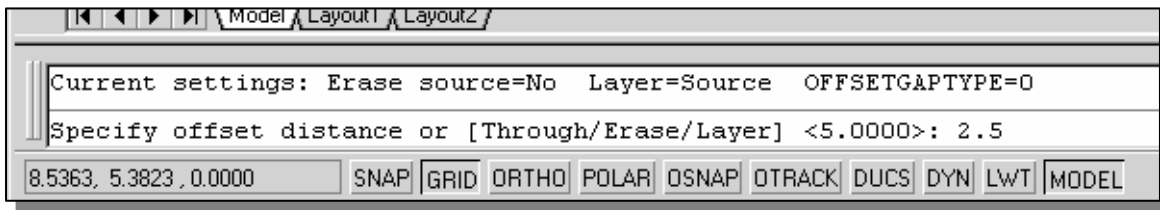

8. In the command prompt area, the message “*Select object to offset or <exit>:*” is displayed. Pick the **horizontal line** on the screen.
9. AutoCAD next asks us to identify the direction of the offset. Pick a location that is **above** the horizontal line.
10. Inside the graphics window, **right-mouse-click** to end the Offset command.
11. Repeat the **Offset** command and create the offset lines as shown.

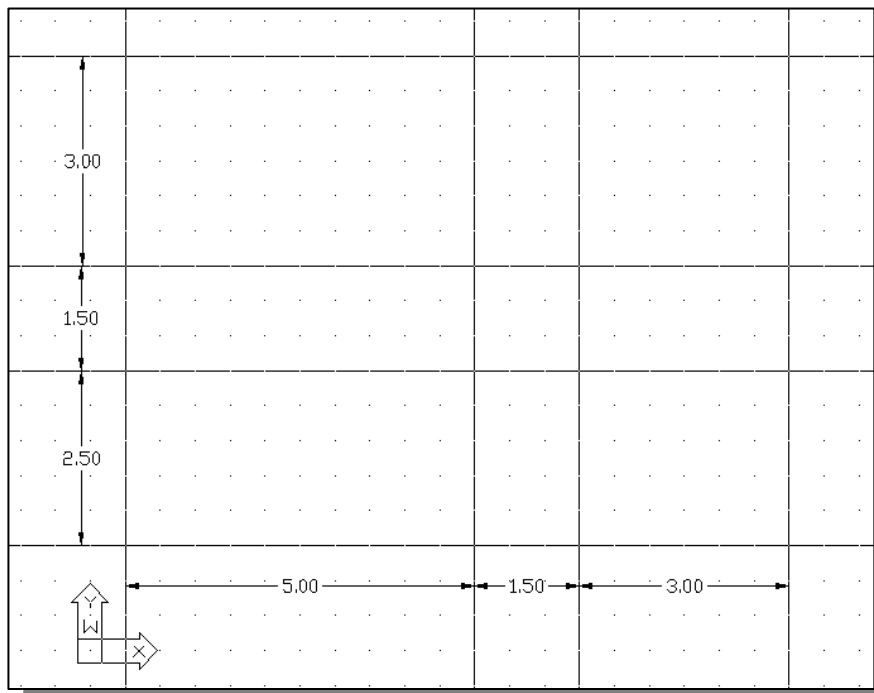

Set layer *Object* as the Current Layer

1. On the *Layers* toolbar panel, choose the *Layer Control* box with the left-mouse-button.
2. Move the cursor over the name of the layer *Object*. The tool tip “*Object*” appears.

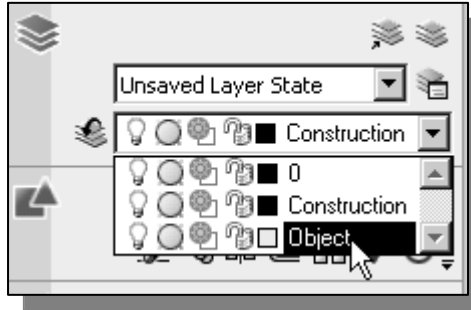

3. Left-mouse-click once and the layer *Object* is set as the *Current Layer*.

Using the *Running Object Snaps*

In **AutoCAD® 2008**, while using geometry construction commands, the cursor can be placed to points on objects such as endpoints, midpoints, centers, and intersections. In AutoCAD, this tool is called the *Object Snap*.

Object snaps can be turned on in one of two ways:

- **Single Point (or override) Object Snaps:** Sets an object snap for one use.
- **Running Object Snaps:** Sets object snaps *active* until we turn them off.

The procedure we have used so far is the *Single Point Object Snaps* option, where we select the specific object snap from the *Object Snap* toolbar for one use only. The use of the *Running Object Snaps* option to assist the construction is illustrated next.

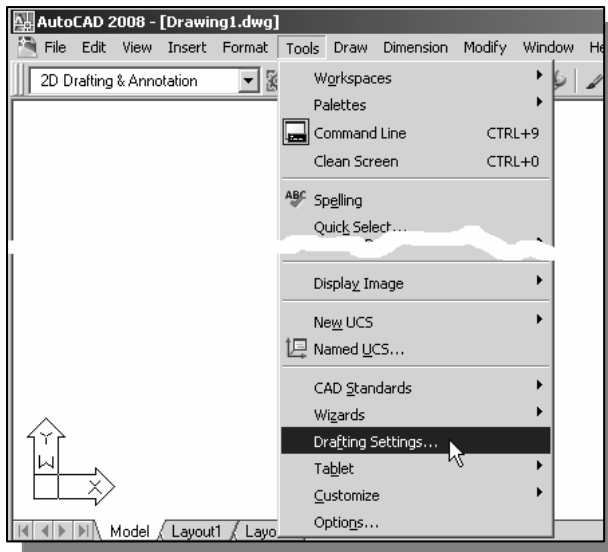

1. In the pull-down menus, select:

[Tools] → [Drafting Settings]

2. In the *Drafting Settings* dialog box select the **Object Snap** tab.

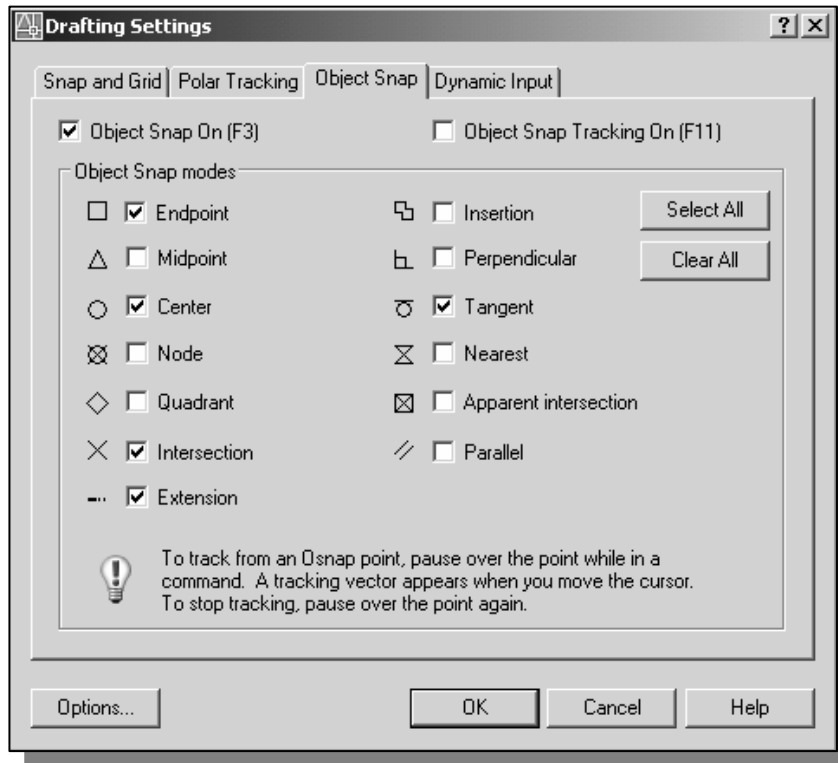

The *Running Object Snap* options can be turned on or off by clicking the different options listed. Notice the different symbols associated with the different *Object Snap* options.

3. Turn **ON** the *Running Object Snap* by clicking the **Object Snap On** box, or hitting the **[F3]** key once.
4. Confirm the **Intersection**, **Endpoint** and **Extension** options are switched **ON** and click on the **OK** button to accept the settings and exit from the *Drafting Settings* dialog box.

❖ Notice in the *Status Bar* area the **OSNAP** button is switched **ON**. We can toggle the *Running Object Snap* option on or off by clicking the **OSNAP** button.

5. Press the **[F3]** key once and notice the **OSNAP** button is switched **OFF** in the *Status Bar* area.



6. Press the **[F3]** key again and notice the **OSNAP** button is now switched **ON** in the *Status Bar* area.

➤ **AutoCAD® 2008** provides many input methods and shortcuts; you are encouraged to examine the different options and choose the option that best fits your own style.

Creating *Object Lines*

We will define the areas for the front-view, top-view and side-view by adding object lines using the *Running Object Snap* option.

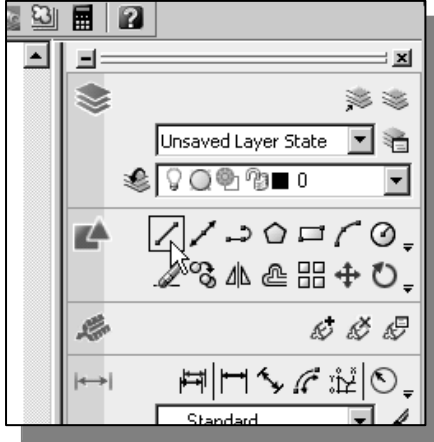

1. Select the **Line** command icon in the *Draw* toolbar. In the command prompt area, the message “_line Specify first point:” is displayed.
2. Move the cursor to the **intersection** of any two lines and notice the visual aid automatically displayed at the intersection.
3. Pick the four intersection points closest to the lower left corner to create the four sides of the area of the front view.

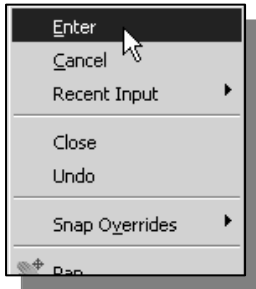

4. Inside the graphics window, right-mouse-click to activate the option menu and select **Enter** with the left-mouse-button to end the *Line* command.

5. Repeat the *Line* command to define the top view and side view as shown.

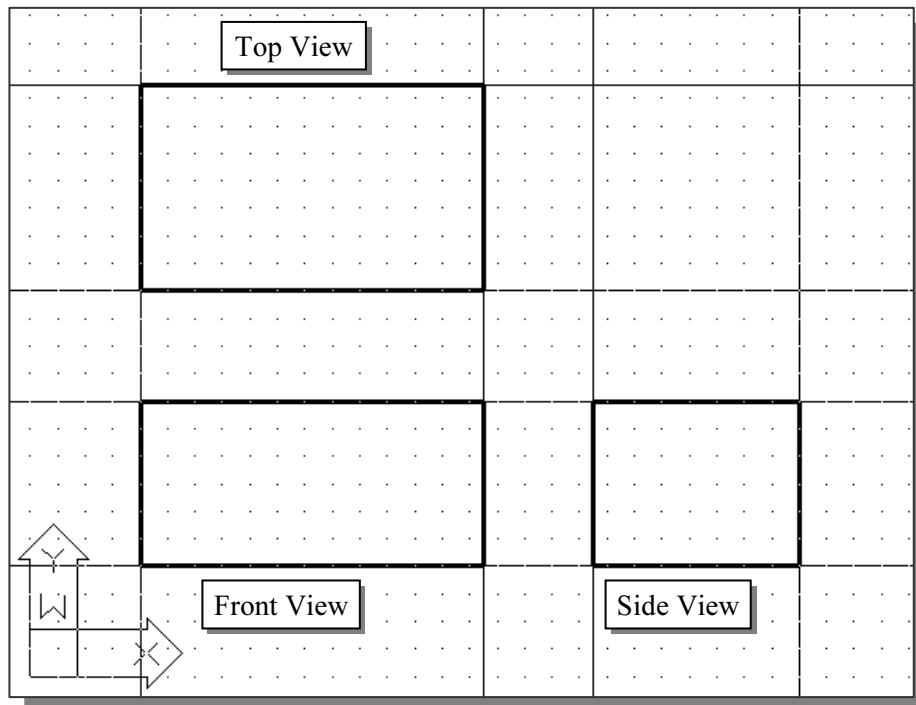

Turn **OFF** the Construction Lines layer

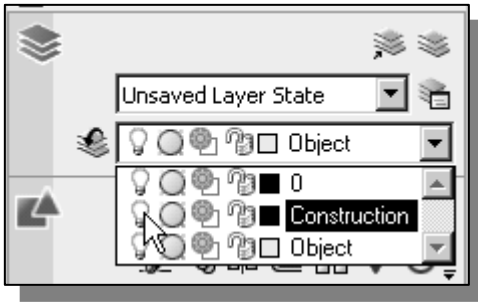

1. On the *Object Properties* toolbar, choose the **Layer Control** box with the left-mouse-button.
2. Move the cursor over the light-bulb icon for layer **Construction**. The tool tip “*Turn a layer On or Off*” appears.

3. **Left-mouse-click once** and notice the icon color is changed to gray, representing the layer (layer *Construction*) is turned **OFF**.

Adding more Objects in the Front View

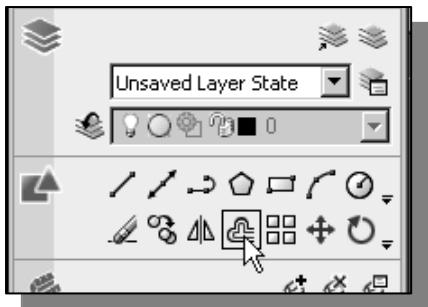

1. Use the **Offset** command and create the two parallel lines in the front view as shown.

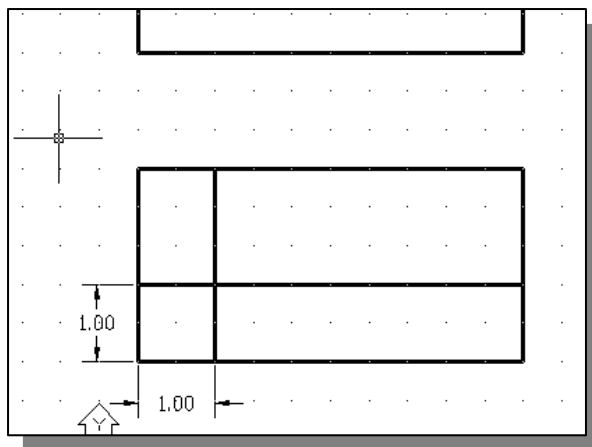

2. Use the **Trim** command and modify the front view as shown.

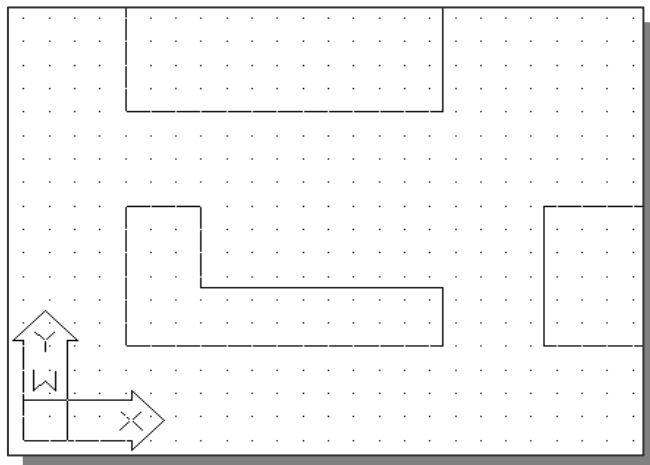
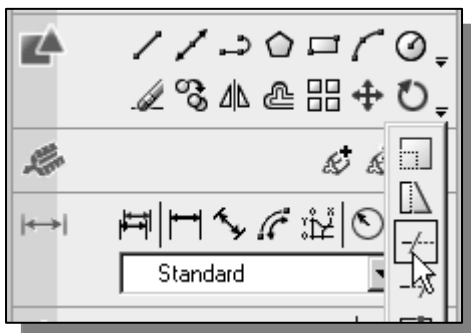

AutoCAD's *AutoSnap*[™] and *AutoTrack*[™] features

AutoCAD's *AutoSnap* and *AutoTrack* provide visual aids when the *Object Snap* options are switched *ON*. The main advantages of *AutoSnap* and *AutoTrack* are as follows:

- **Symbols:** Automatically displays the *Object Snap* type at the object snap location.
- **Tooltips:** Automatically displays the *Object Snap* type below the cursor.
- **Magnet:** Locks the cursor onto a snap point when the cursor is near the point.

With ***Object Snap Tracking***, the cursor can track along alignment paths based on other object snap points when specifying points in a command. To use *Object Snap Tracking*, one or more object snaps must be switched on. The basic rules of using the ***Object Snap Tracking*** option are as follows:

- To track from a *Running Object Snap* point, pause over the point while in a command.
- A tracking vector appears when we move the cursor.
- To stop tracking, pause over the point again.
- When multiple *Running Object Snaps* are on, press the **[TAB]** key to cycle through available snap points when the object snap aperture box is on an object.

1. In the *Status Bar* area, turn *ON* the *OTRACK* option.

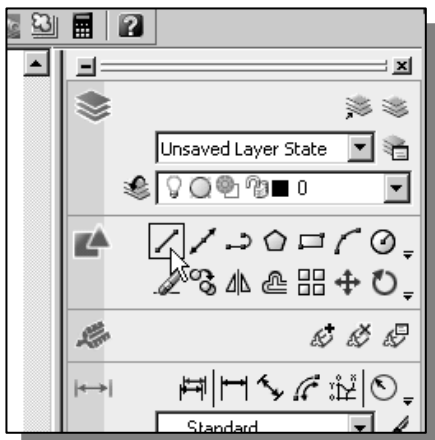
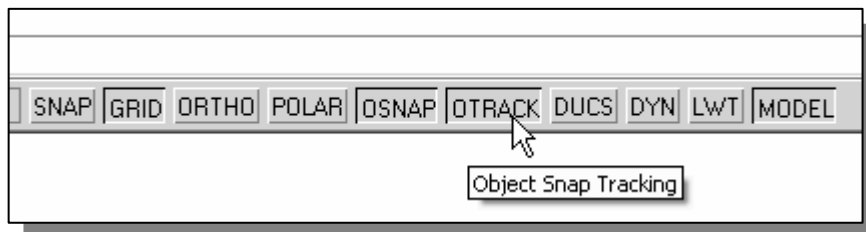

2. Select the **Line** command icon in the *Draw* toolbar. In the command prompt area, the message “*_line Specify first point:*” is displayed.

3. Move the cursor near the top right corner of the vertical protrusion in the front view. Notice that *AutoSnap* automatically locks the cursor to the corner and displays the *Endpoint* symbol.

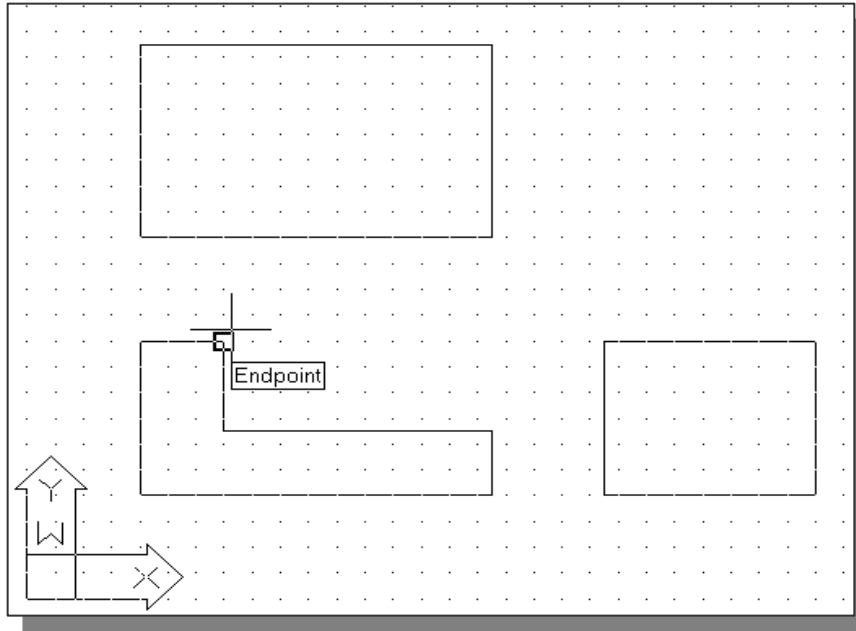

4. Move the cursor upward and notice that *Object Tracking* displays a dashed line, showing the alignment to the top right corner of the vertical protrusion in the front view. Move the cursor near the top horizontal line of the top view and notice that *AutoSnap* displays the intersection point.

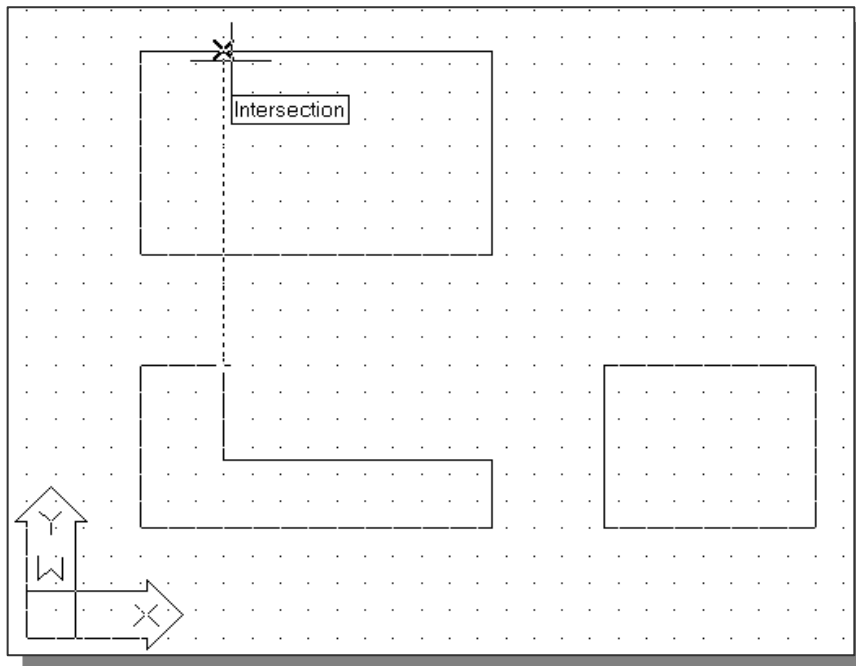

5. Left-mouse-click to place the starting point of a line at the intersection.

6. Move the cursor to the top left corner of the front view to activate the tracking feature.

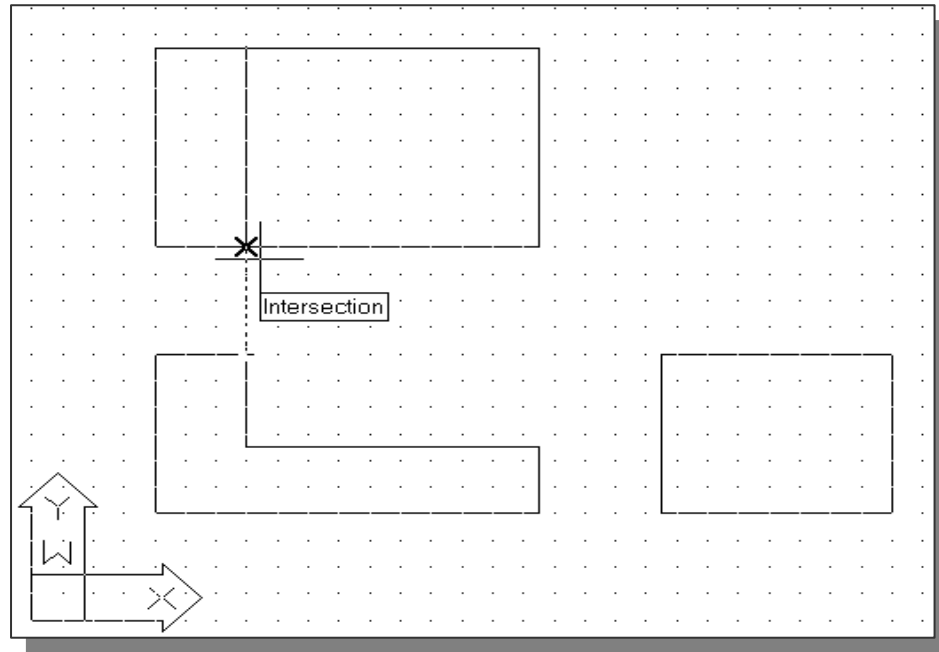

7. Create the line as shown in the above figure.

Adding more objects in the Top View

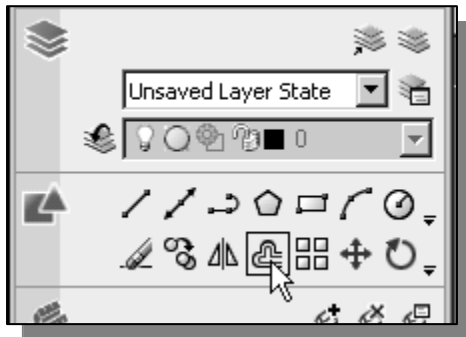

1. Use the **Offset** command and create the two parallel lines in the top view as shown.

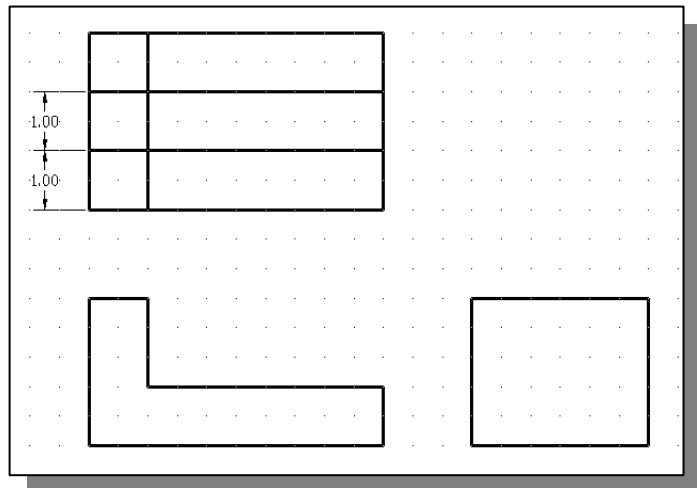

2. Move the cursor to the *Standard* toolbar area and **right-mouse-click** on any icon to display a list of toolbar menu groups.

3. Select **Object Snap**, with the left-mouse-button, to display the *Object Snap* toolbar on the screen.

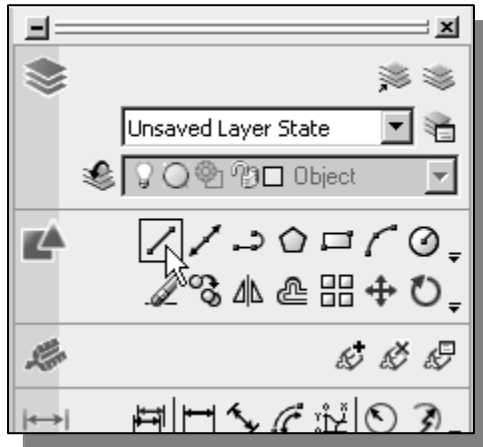

4. Select the **Line** command icon in the *Draw* toolbar. In the command prompt area, the message “_line Specify first point:” is displayed.
5. In the *Object Snap* toolbar, pick **Snap From**. In the command prompt area, the message “_from Base point” is displayed. AutoCAD now expects us to select a geometric entity on the screen.

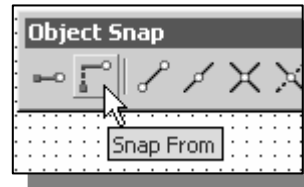

➤ The *Single Point Object Snap* overrides the *Running Object Snap* option.

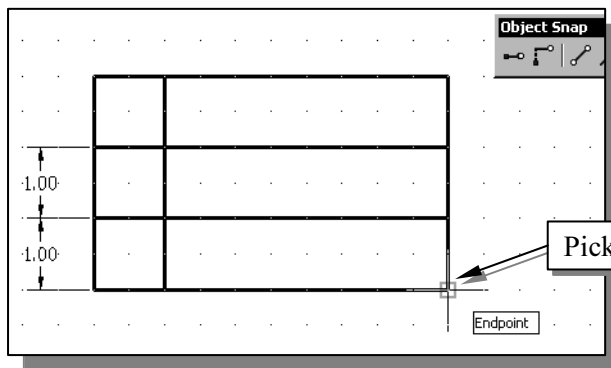

6. We will measure relative to the lower right corner. Pick the corner as shown.

7. In the *command prompt* area, enter **@0,25 [ENTER]**.

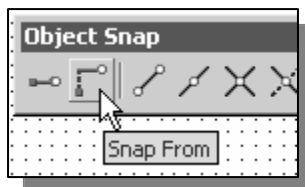

8. In the *Object Snap* toolbar, pick **Snap From**. Pick the lower right corner of the top view again.

9. In the *command prompt* area, enter **@-1.75,0 [ENTER]**.

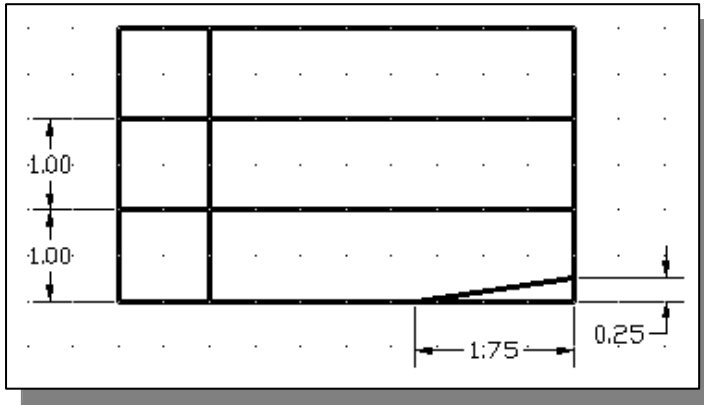

10. Inside the graphics window, right-mouse-click to activate the option menu and select **Enter** with the left-mouse-button to end the Line command.

11. Repeat the procedure and create the line and circle (diameter 1.0) as shown in the figure below.

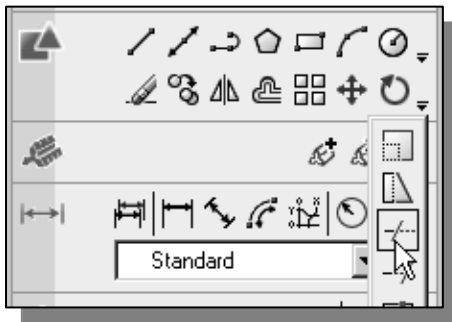
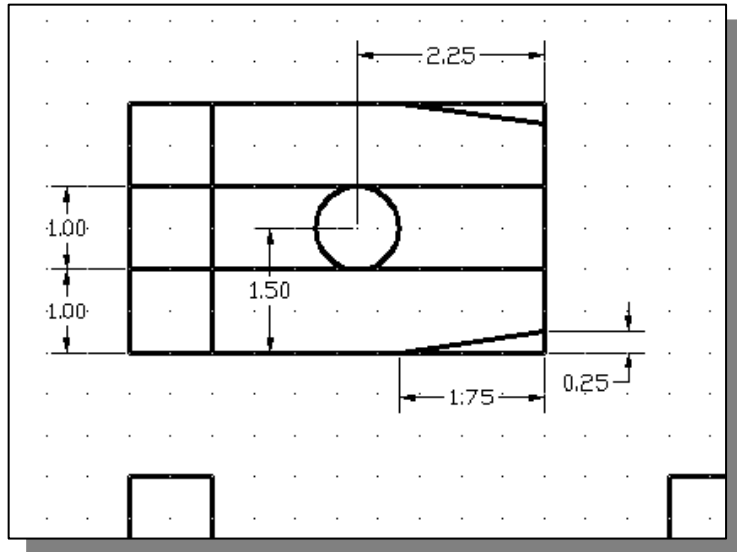

12. Select the **Trim** icon in the *Modify* toolbar. In the command prompt area, the message “*Select boundary edges... Select objects:*” is displayed.
13. Pick the following objects as boundary edges: the circle, and the lines that are near the circle.

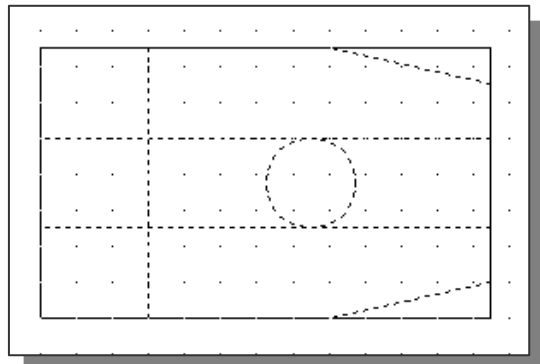

14. Inside the graphics window, **right-mouse-click** to accept the selected objects.
15. Select the unwanted portions and modify the objects as shown.

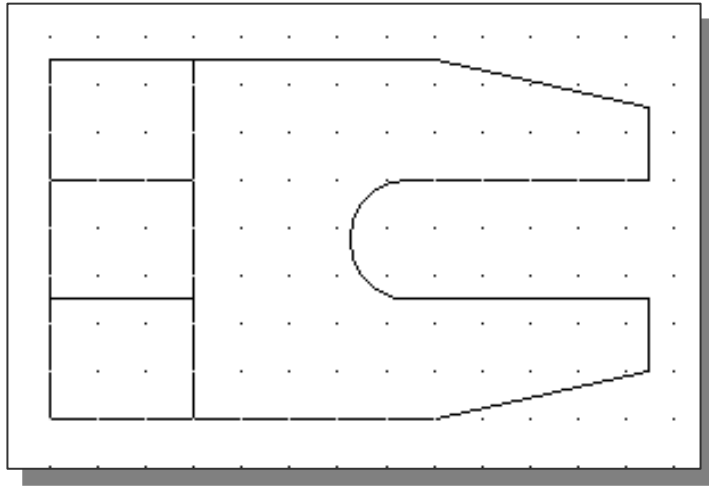

16. On your own, use the **Offset** and **Trim** commands and modify the top view as shown.

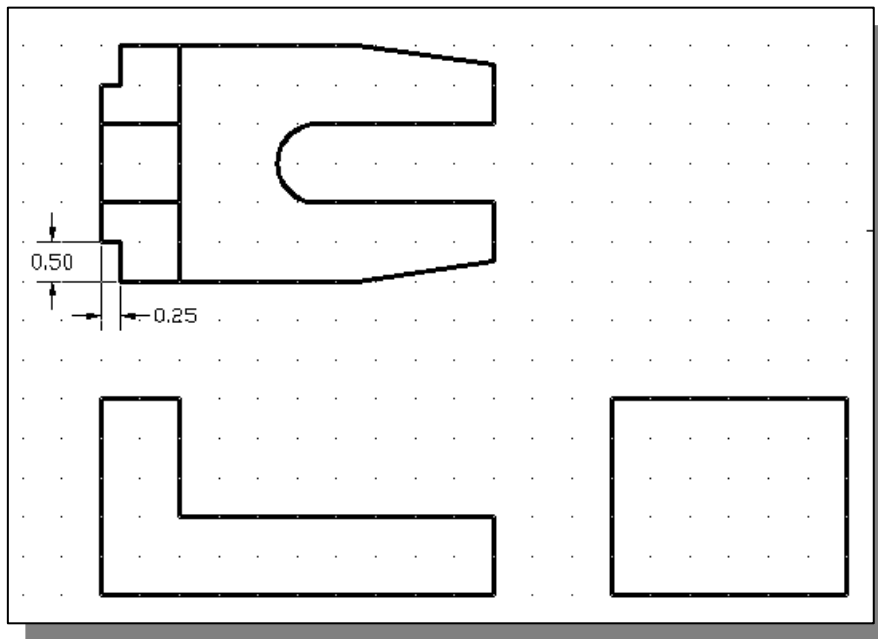
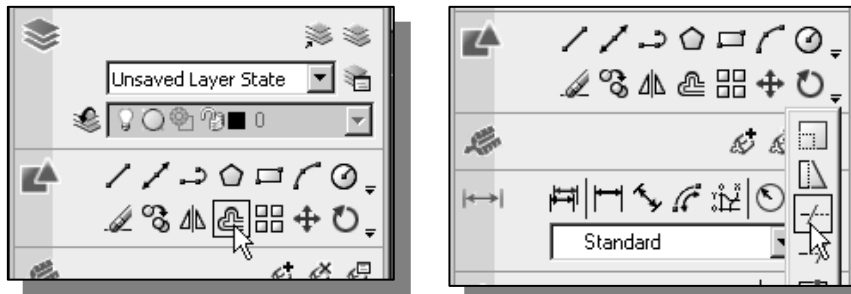

Drawing using the *Miter Line* method

- ❖ The 45° *miter line* method is a simple and straightforward procedure to transfer measurements in between the top view and the side view.

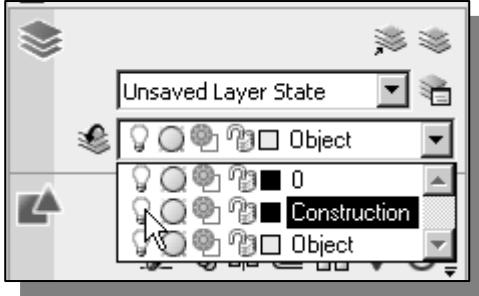

1. On the *Layers* toolbar panel, choose the **Layer Control** box by clicking once with the left-mouse-button.
2. Move the cursor over the **light-bulb** icon for layer **Construction**. The tool tip “*Turn a layer On or Off*” appears.
3. **Left-mouse-click once** and notice the icon color is changed to a light color, representing the layer (layer *Construction*) is turned *ON*.
4. **Left-mouse-click once** over the name of the layer **Construction** to set it as the *Current Layer*.
5. Use the **Line** command and create the *miter line* by connecting the two intersections of the construction lines as shown.

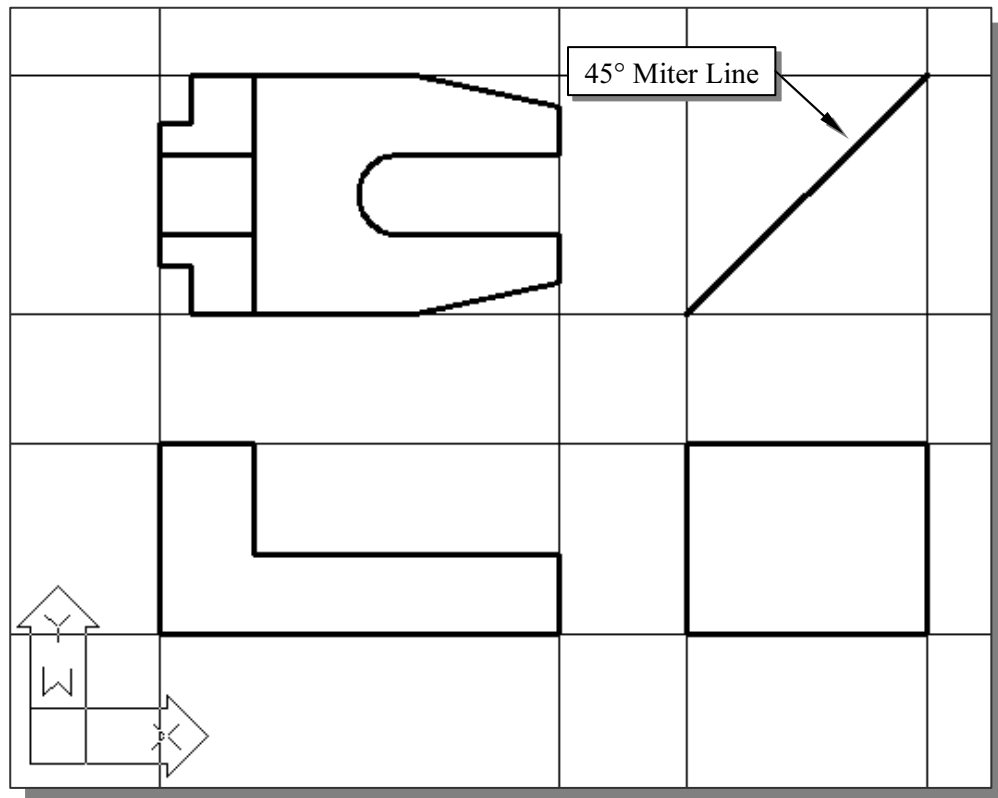

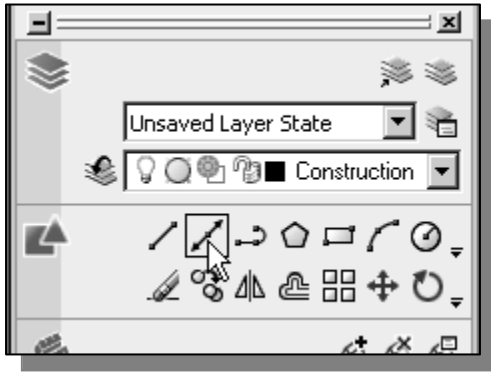

6. Select the **Construction Line** command in the *Draw* toolbar as shown.



7. Inside the graphics area, right-mouse-click once and select the **Horizontal** option as shown.

- 8. On your own, create horizontal projection lines through all the corners in the top view as shown.
- 9. Use the **Trim** command and trim the projection lines as shown in the figure below.

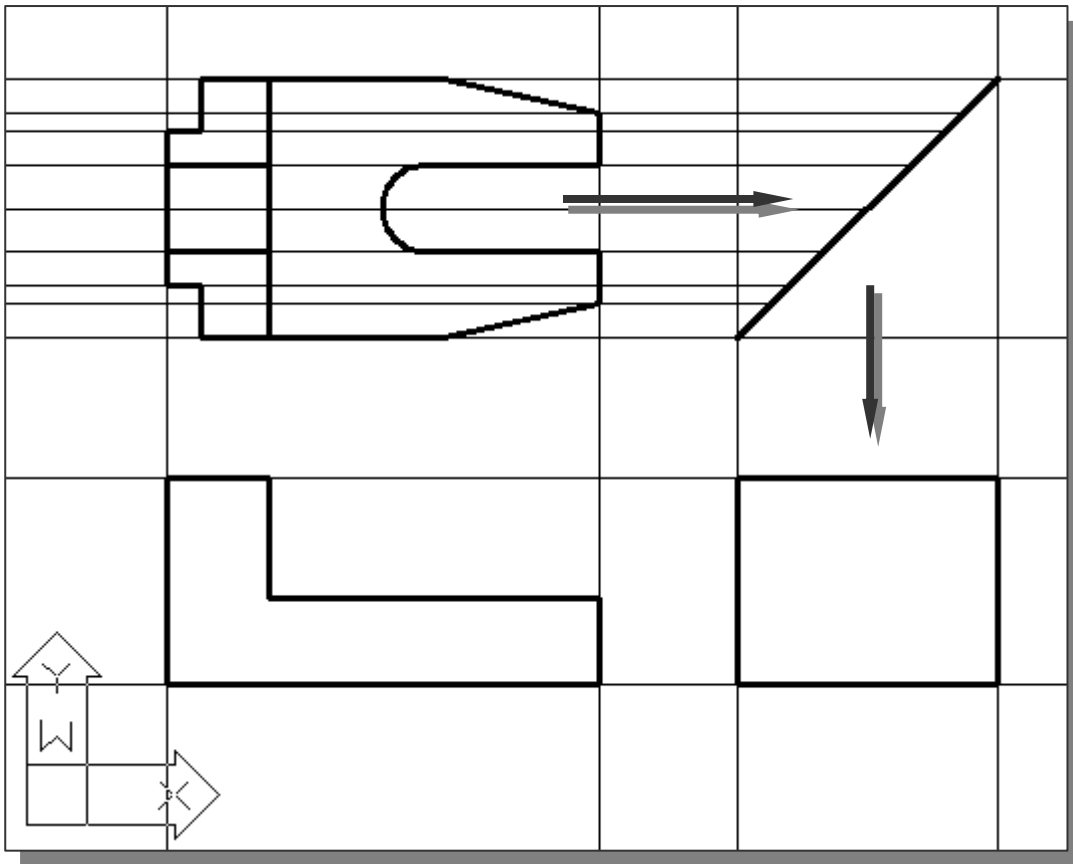

10. Add Construction Lines (vertical option) through all the intersection points that are on the *miter line*.

More Layers Setup

1. Pick **Layer Properties Manager** in the *Layers* toolbar panel as shown in the figure below.

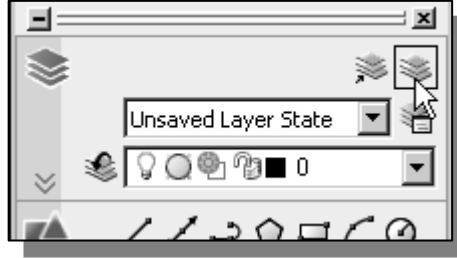

2. Click on the **New** icon to create new layers.
3. Create two **new layers** with the following settings:

<i>Layer</i>	<i>Color</i>	<i>Linetype</i>
Hidden	Cyan	HIDDEN
Center	Red	CENTER

- The default linetype is *Continuous*. To use other linetypes, click on the **Load** button in the *Select Linetype* dialog box and select the desired linetypes.

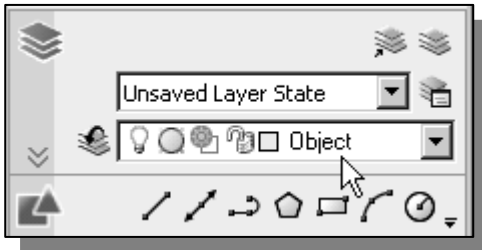
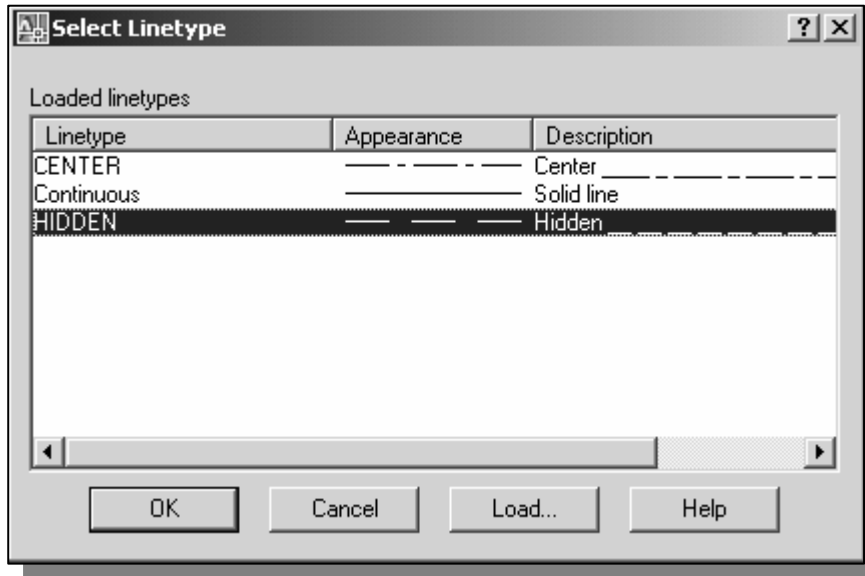

4. On your own, set the layer **Object** as the *Current Layer*.

Top View to Side View Projection

1. Using the *Running Object Snaps*, create the necessary **object-lines** in the side view.

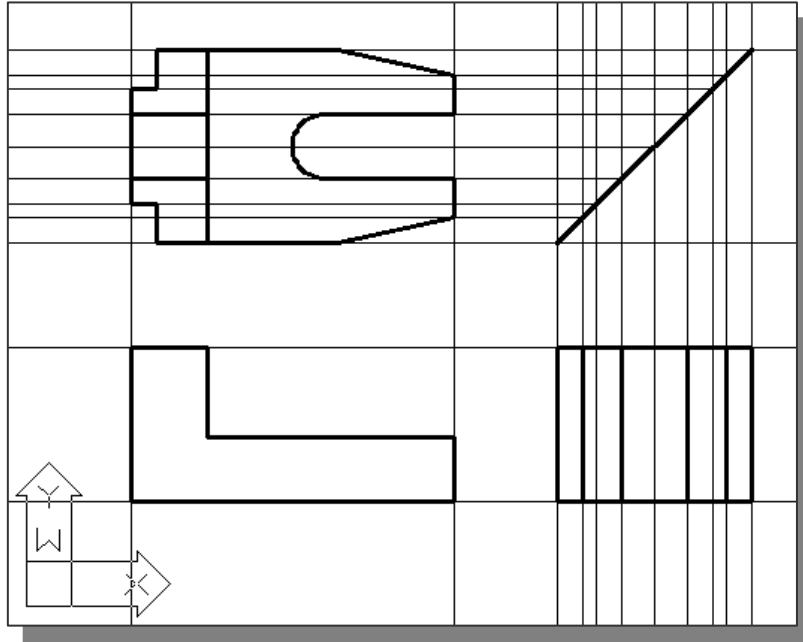

2. Set layer **Hidden** as the *Current Layer* and create the two necessary hidden lines in the side view.
3. Set layer **Center** as the *Current Layer* and create the necessary centerlines in the side view.

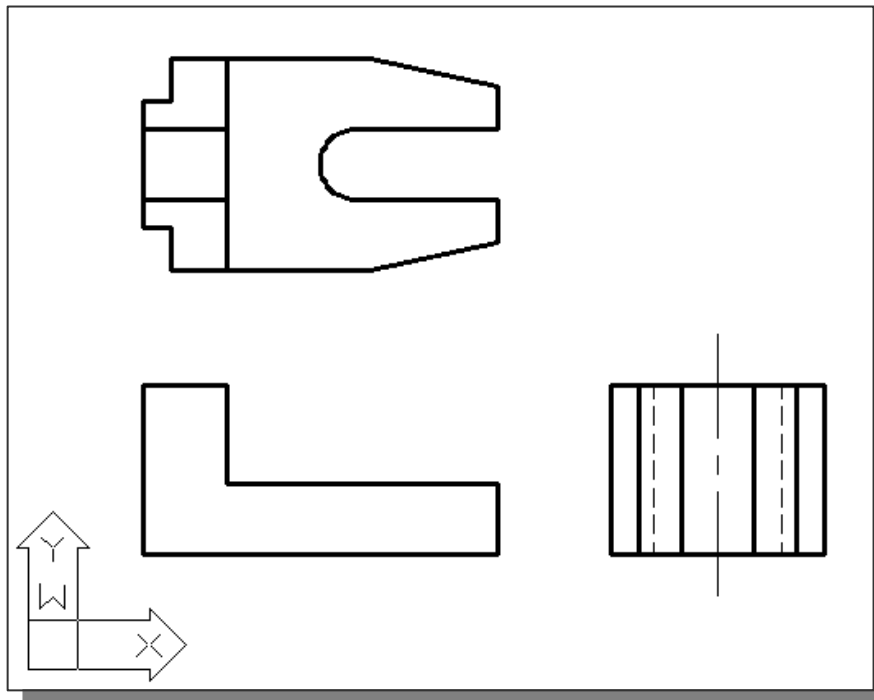

4. In the *Layer Control* box, turn **OFF** the construction lines.
5. Set layer **Object** as the *Current Layer*.

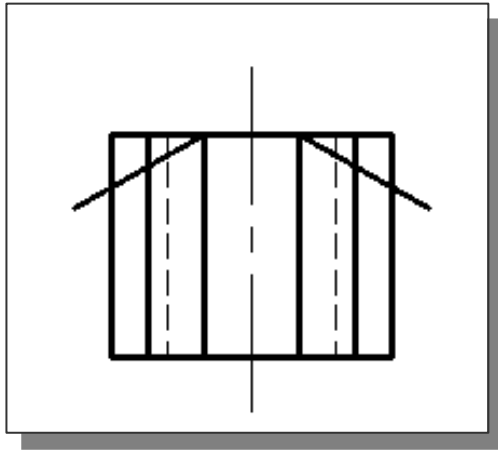

6. Use the **Line** command and create the two 30° inclined lines as shown.

(Hint: Use relative coordinate entries of @2.0<-30 and @2.0<210)

7. Use the **Line** command and create a horizontal line in the side view as shown.

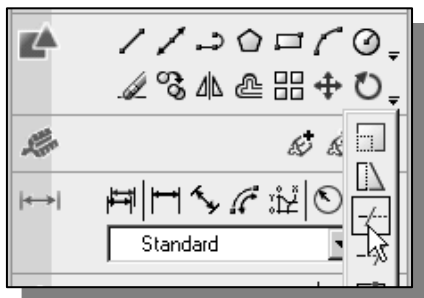
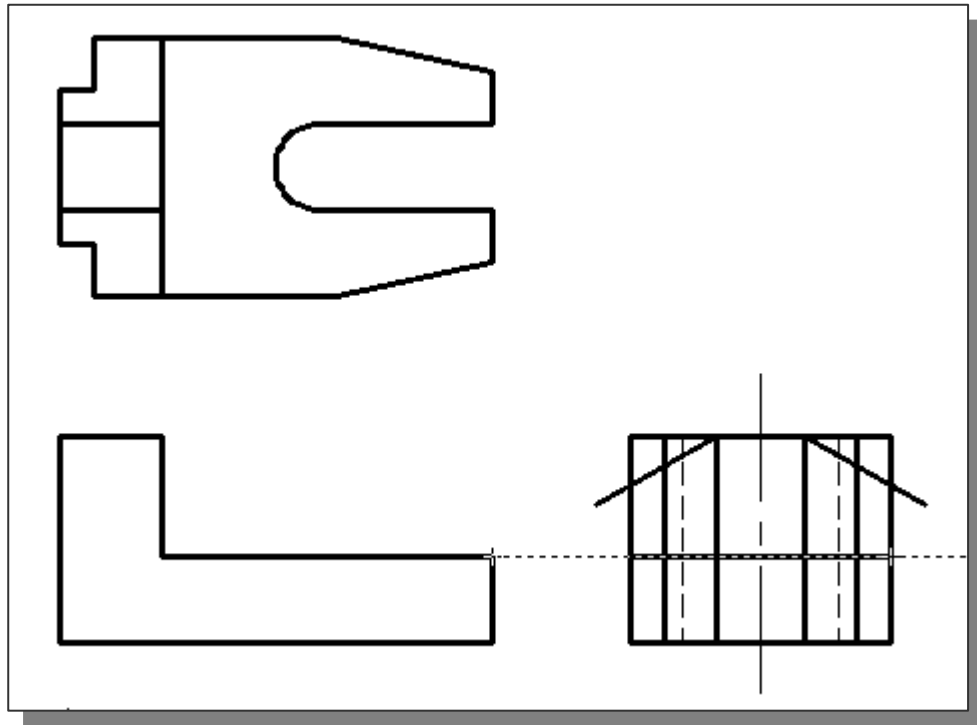

8. On your own, use the **Trim** command and remove the unwanted portions in the side view.

Completing the Front View

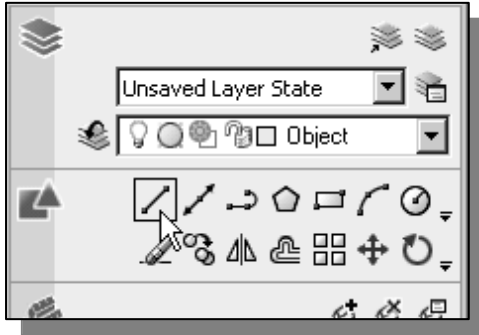

1. Select the **Line** command icon in the *Draw* toolbar. In the command prompt area, the message “*_line Specify first point:*” is displayed.
2. Move the cursor to the top left corner in the side view and the bottom left corner in the top view to activate the *Object Tracking* option to both corners.
3. Left-mouse-click once when the cursor is aligned to both corners as shown.

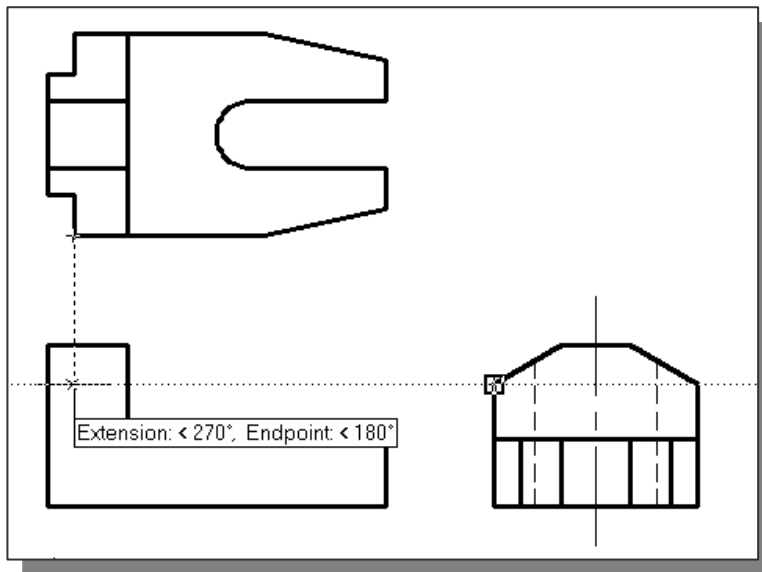

4. Create the **horizontal line** as shown.

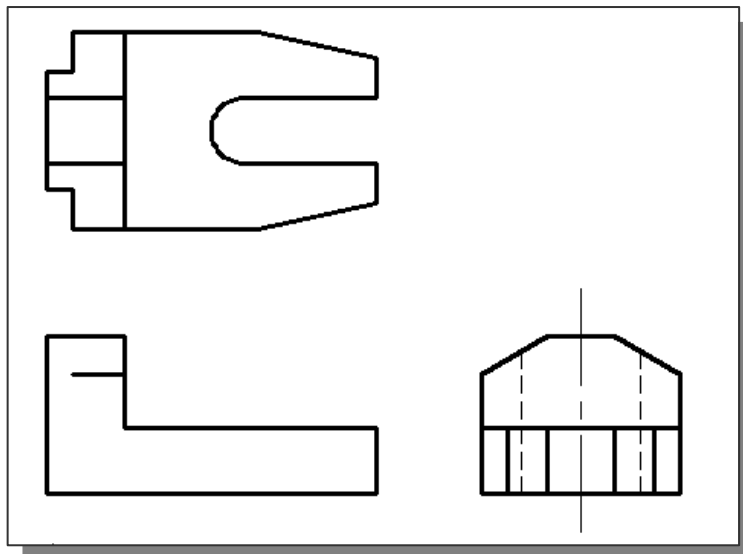

5. Repeat the procedure and create the lines in the front view as shown.

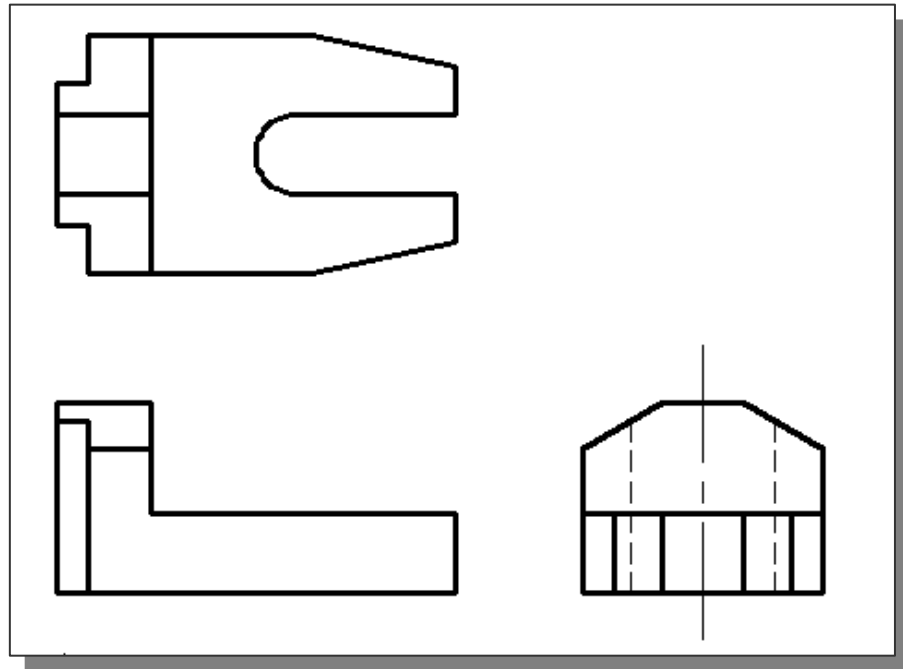

6. Add in any additional object lines that are necessary.
7. Set layer **Hidden** as the *Current Layer* and create the necessary hidden lines in the front view.
8. Set layer **Center** as the *Current Layer* and create the necessary centerlines in the top view and front view.

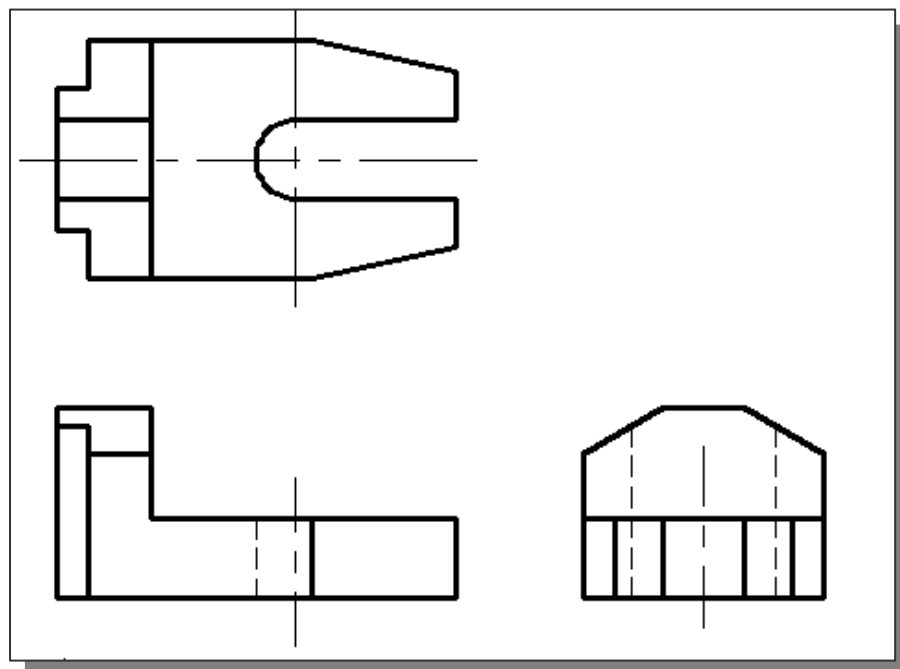

Questions:

1. Explain what an orthographic view is and why it is important to engineering graphics.
2. Describe the difference between 1st and 3rd angle projections used in engineering graphics.
3. What does the *Running Object Snaps* option allow us to do?
4. Explain how a *miter line* can assist us in creating orthographic views.
5. Describe the AutoCAD *AutoSnap* and *AutoTrack* options.
6. Identify the following commands:

(a)

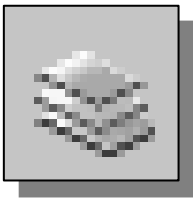

(b)

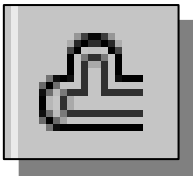

(c)

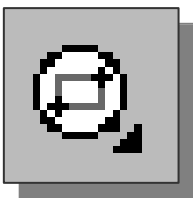

(d)



Exercises: (Unless otherwise specified, dimensions are in inches.)

1.

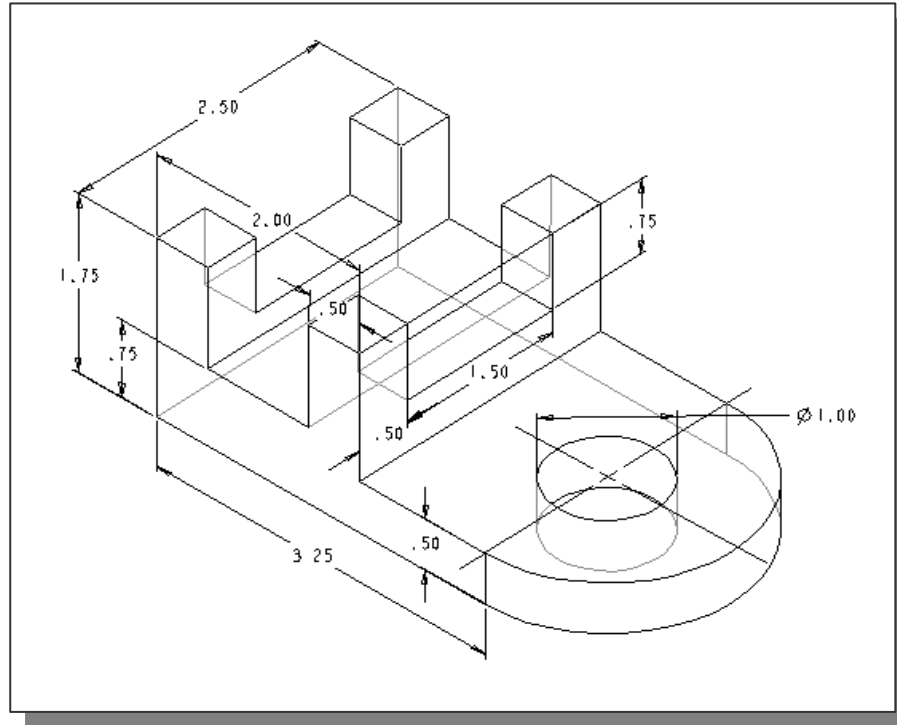

2.

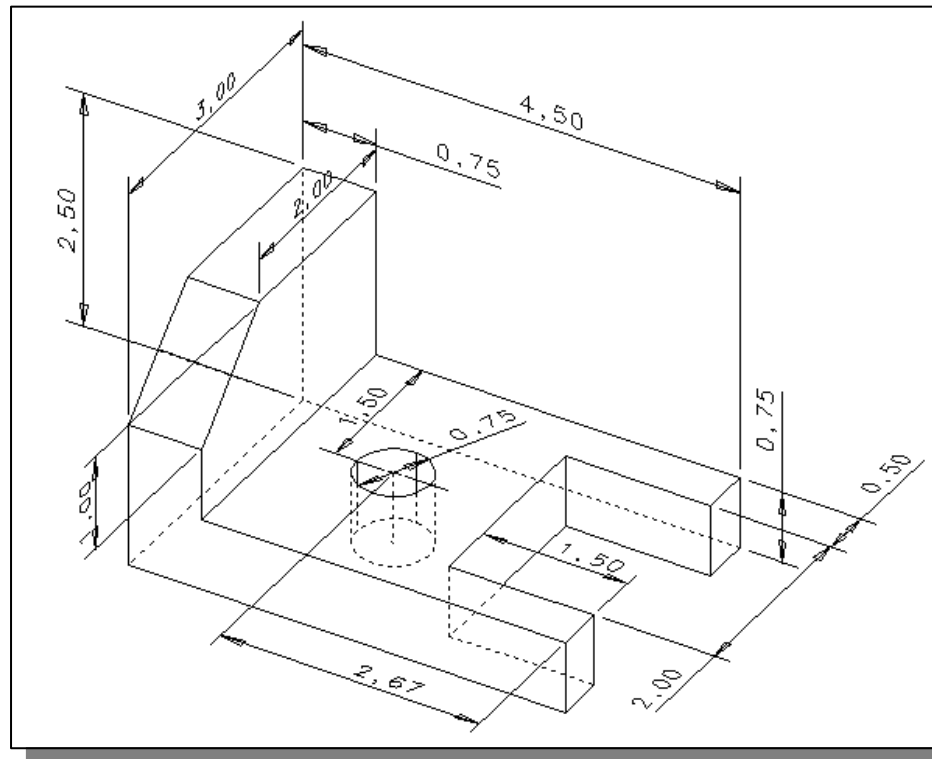

3.

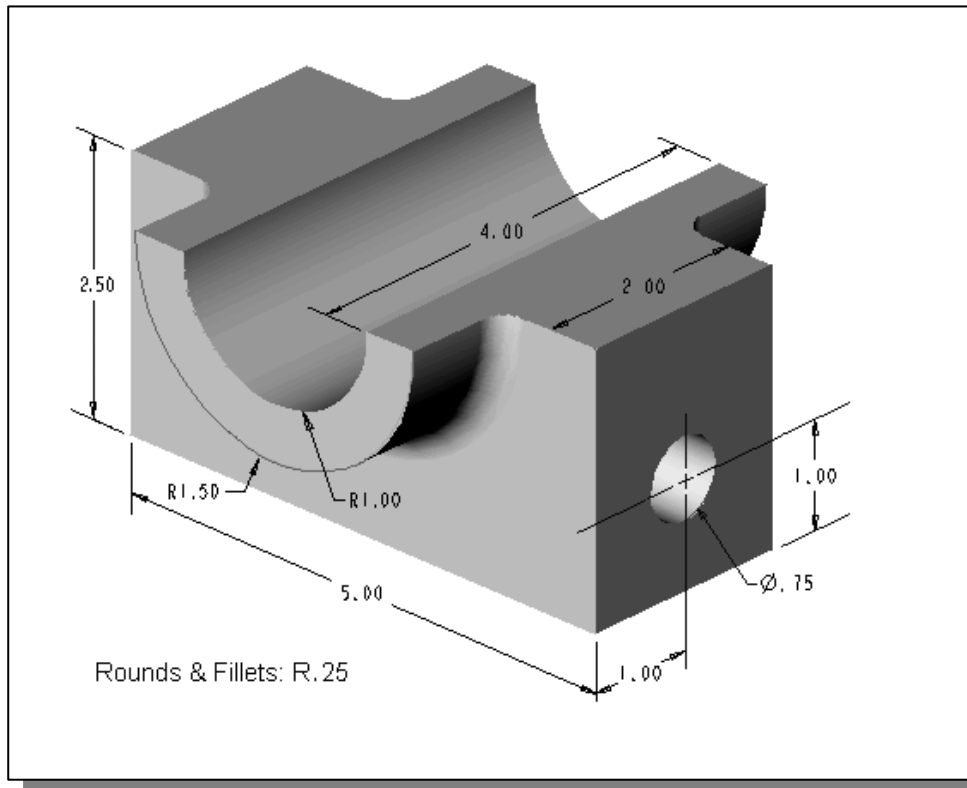

4. Dimensions are in Millimeters.

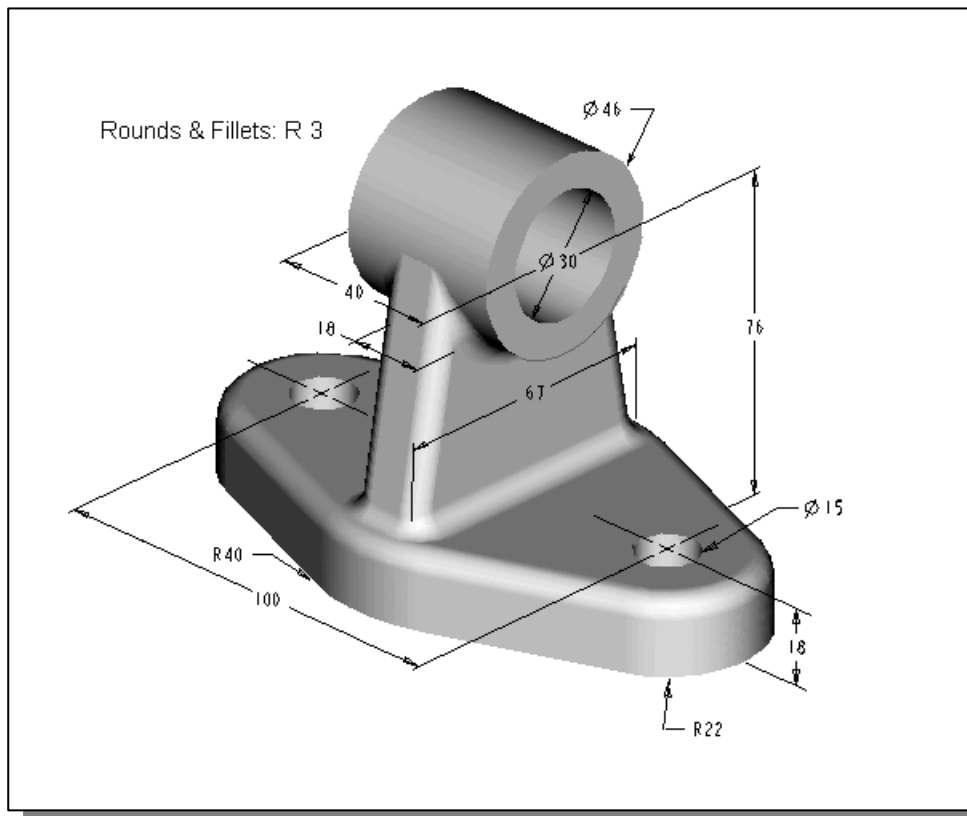

5.

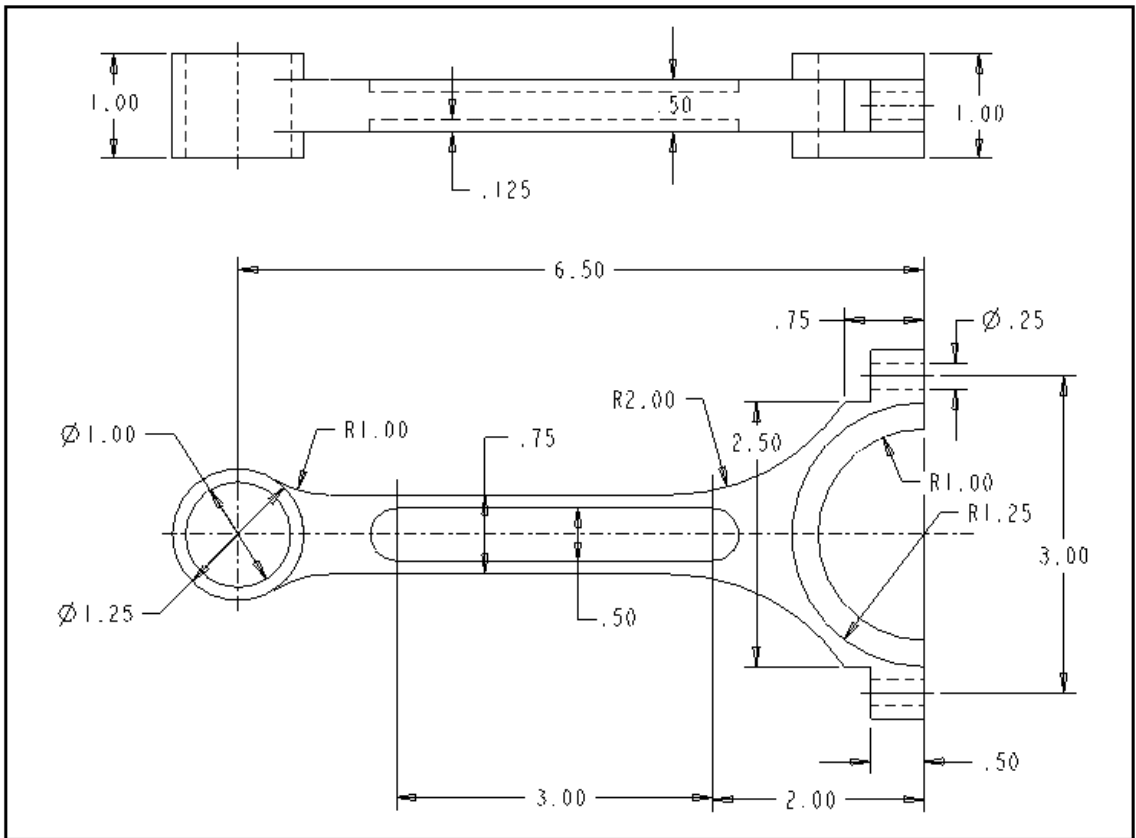
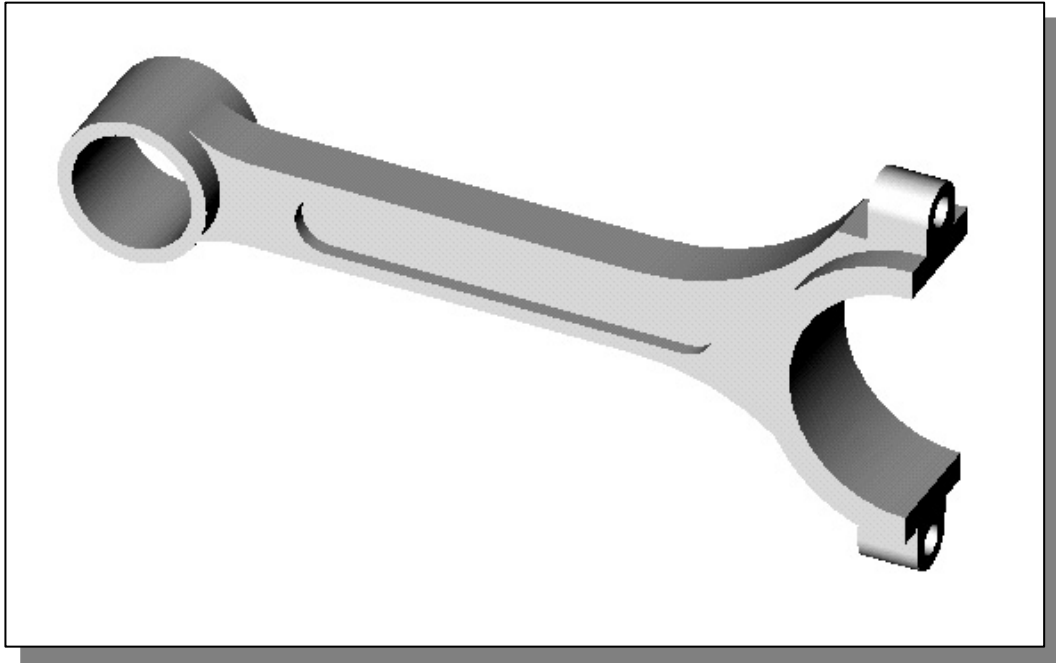

Notes: