

INSIDE:

MultiMedia CD

An audio/visual
presentation of the
tutorial projects

SolidWorks 2009 Tutorial

Introductory Level ♦ Project Based Tutorials ♦ Video Instruction

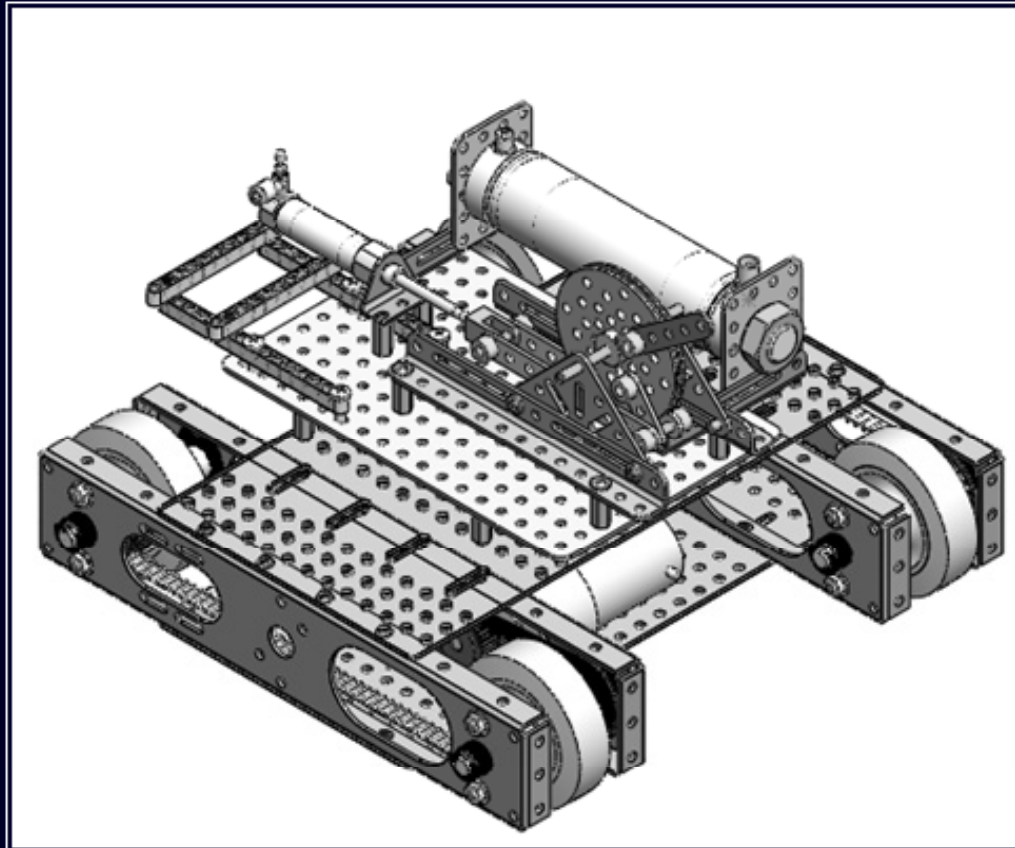

David C. Planchard & Marie P. Planchard, CSWP

**Included
in this book:**

Exercises and models
to prepare for the

**SolidWorks
Certification
Exam**

SDC
PUBLICATIONS

Schroff Development Corporation
www.schroff.com

Better Textbooks

Lower Prices

SolidWorks

Solution
Partner

Project 1

LINKAGE Assembly

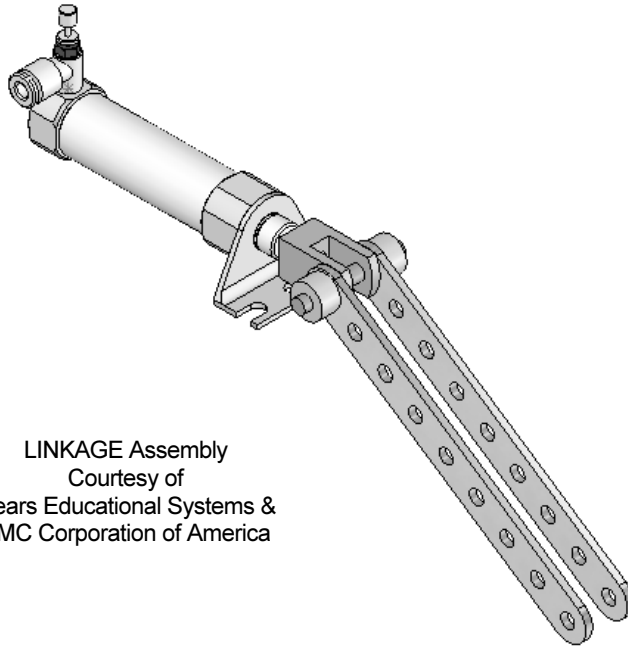

LINKAGE Assembly
Courtesy of
Gears Educational Systems &
SMC Corporation of America

Below are the desired outcomes and usage competencies based on the completion of Project 1.

Desired Outcomes:	Usage Competencies:
<ul style="list-style-type: none">• Create three parts:<ul style="list-style-type: none">○ AXLE○ SHAFT-COLLAR○ FLATBAR	<ul style="list-style-type: none">• Understand the SolidWorks default User Interface. Establish a SolidWorks session.• Create 2D sketch profiles on the correct Sketch plane.• Apply the following 3D features: Extruded Base, Extruded Cut, and Linear Pattern.
<ul style="list-style-type: none">• Create an assembly:<ul style="list-style-type: none">○ LINKAGE assembly	<ul style="list-style-type: none">• Understand the Assembly toolbar.• Insert components into an assembly.• Insert the following Standard mates: Concentric, Coincident, and Parallel.

Notes:



Project 1 – LINKAGE Assembly

Project Objective

SolidWorks is a design software application used to model and create 2D and 3D sketches, 3D parts, assemblies, and 2D drawings. The Project objective is to provide a comprehensive understanding of the SolidWorks default User Interface and CommandManager: *Menu bar toolbar, Menu bar menu, Drop-down menu, Context toolbar / menus, Flyout FeatureManager, System feedback, Confirmation Corner, Heads-up View toolbar and an understanding of Document Properties.*

Obtain the working familiarity of the following SolidWorks sketch and feature tools: Line, Circle, Centerpoint Straight Slot, Smart Dimension, Extruded Base, Extruded Cut, and Linear Pattern.

Create three individual parts: AXLE, SHAFT-COLLAR, and FLATBAR.

Create an assembly using the three created parts and a downloaded sub-assembly from the CD in the book:

- LINKAGE assembly.

On the completion of this project, you will be able to:

- Start a SolidWorks session and navigate through the SolidWorks (UI) and CommandManager.
- Set units and dimensioning standards for a SolidWorks document.
- Generate a 2D sketch and identify the correct Sketch plane.
- Add and modify sketch dimensions.
- Create a 3D model.
- Understand and apply the following SolidWorks features:
 - Extruded Base, Extruded Cut, and Linear Pattern
- Insert the following Geometric relations: MidPoint and Equal.
- Download an assembly into SolidWorks and create an assembly.
- Understand the Assembly toolbar.
- Apply the following Standard mates: Coincident, Concentric and Parallel.

Project Overview

SolidWorks is a 3D solid modeling CAD software package used to produce and model parts, assemblies, and drawings.

SolidWorks provides design software to create 3D models and 2D drawings.

Create three parts in this project:

- AXLE
- SHAFT-COLLAR
- FLATBAR

Download the AirCylinder assembly from the enclosed CD.

 The AirCylinder assembly is also available to download from the internet.

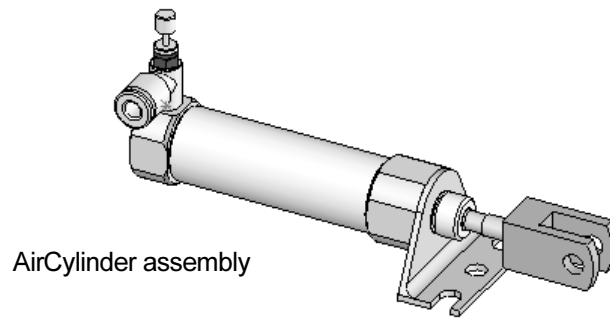
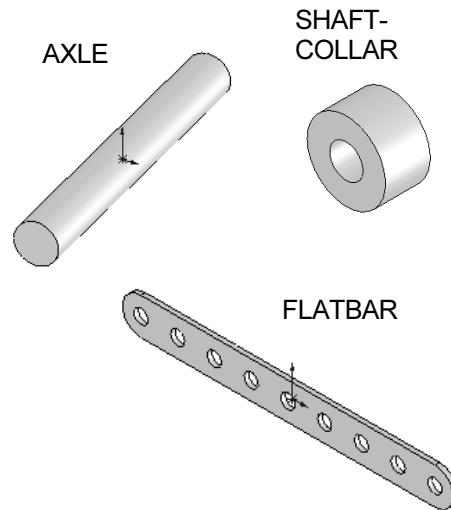

Combine the created parts and the downloaded AirCylinder assembly to create the LINKAGE assembly.

 Screen shots and illustrations in the book display the SolidWorks user default setup and interface for SP1.0.

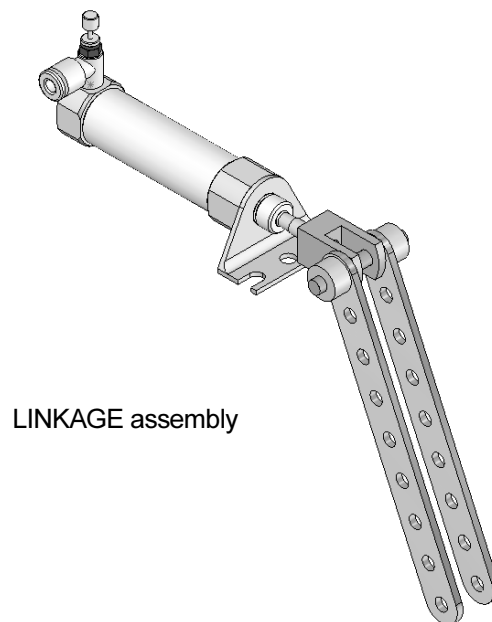

AXLE Part

The AXLE is a cylindrical rod. The AXLE supports the two FLATBAR parts.

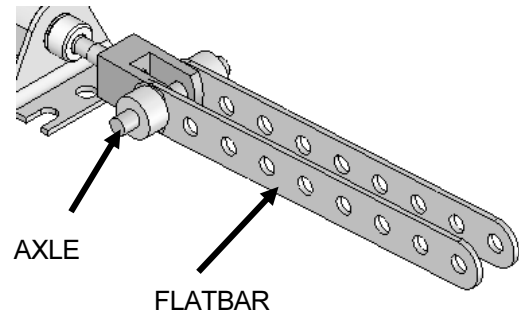

The AXLE rotates about its axis. The dimensions for the AXLE are determined from the other components in the LINKAGE assembly.

Start a new SolidWorks session. Create the AXLE part.

Use features to create parts. Features are the building blocks that add or remove material.

Utilize the Extruded Base  tool from the Features toolbar. The Extruded Base feature adds material. The Base feature is the first feature of the part. The Base feature is the foundation of the part. Keep the Base feature simple!

The Base feature geometry for the AXLE is a simple extrusion. How do you create a solid Extruded Base feature for the AXLE?

- Select the Front Plane as the Sketch plane.
- Sketch a circular 2D profile on the Front Plane, centered at the Origin as illustrated.
- Apply the Extruded Base Feature. Extend the profile perpendicular (\perp) to the Front Plane.

Utilize symmetry. Extrude the sketch with the Mid Plane End Condition in Direction 1. The Extruded Base feature is centered on both sides of the Front Plane.

Start a SolidWorks session. The SolidWorks application is located in the Programs folder.

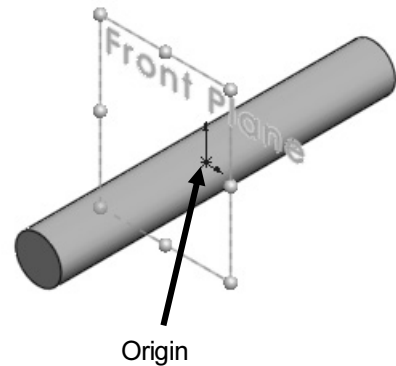
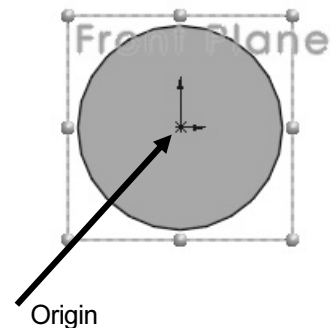
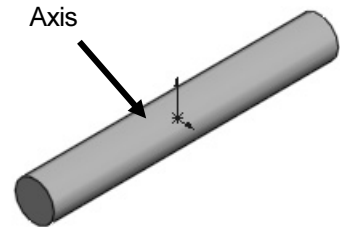

SolidWorks displays the Tip of the Day box. Read the Tip of the Day to obtain additional knowledge on SolidWorks.

Create a new part. Select File, New from the Menu bar toolbar or click New  from the Menu bar menu. There are two options for new documents: Novice and Advanced. Select the Advanced option. Select the default Part document.

Activity: Start a SolidWorks Session

Start a SolidWorks 2009 session.

- 1) Click **Start** from the Windows Taskbar.
- 2) Click **All Programs** All Programs .
- 3) Click the **SolidWorks 2009** folder.
- 4) Click the **SolidWorks 2009** application. The SolidWorks program window opens. Note: Do not open a document at this time.



If available, double-click the SolidWorks 2009 icon on the Windows Desktop to start a SolidWorks session.



The book was written using SolidWorks Office 2003 on Windows XP Professional SP3.0 with a Windows Classic desktop theme.







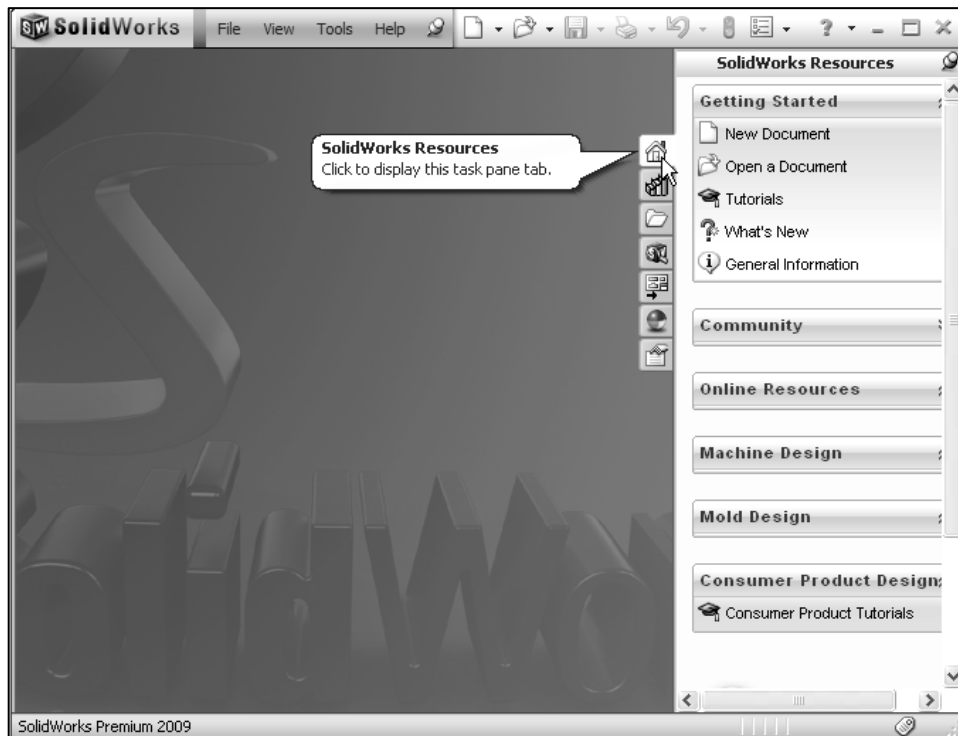

Read the Tip of the Day dialog box.

- 5) If you do not see this screen, click the SolidWorks **Resources**  tab on the right side of the Graphics window located in the Task Pane as illustrated.



Activity: Understand the SolidWorks User Interface and CommandManager

Menu bar toolbar

SolidWorks 2009 (UI) is design to make maximum use of the Graphics window area. The default Menu bar toolbar contains a set of the most frequently used tool buttons from the Standard toolbar. The available tools are: **New**  – Creates a new document, **Open**  – Opens an existing document, **Save**  – Saves an active document, **Print**  – Prints an active document, **Undo**  – Reverses the last action, **Rebuild**  – Rebuilds the active part, assembly or drawing, **Options**  – Changes system options and Add-Ins for SolidWorks.



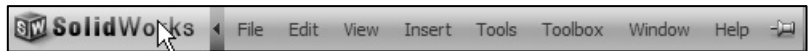
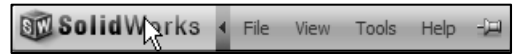

Menu bar menu

Click SolidWorks in the Menu bar toolbar to display the Menu bar menu. SolidWorks provides a Context-sensitive menu structure. The menu titles remain the same for all three types of documents, but the menu items change depending on which type of document is active.



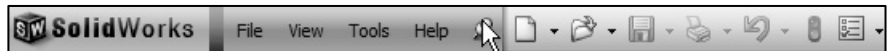

Example: The Insert menu includes features in part documents, mates in assembly documents, and drawing views in drawing documents. The display of the menu is also dependent on the work flow customization that you have selected. The default menu items for an active document are: *File, Edit, View, Insert, Tools, Window, Help, and Pin.*

 The Pin  option displays the Menu bar toolbar and the Menu bar menu as illustrated. Throughout the book, the Menu bar menu and the Menu bar toolbar is referred to as the Menu bar.

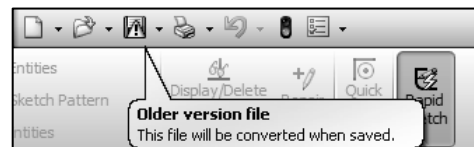

 Until a file is converted to the current version of SolidWorks and saved, a warning icon is displayed on the Save tool as illustrated.



 Expand the drop-down menu to display additional options and tools.

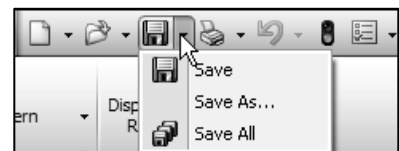

Drop-down menu

SolidWorks takes advantage of the familiar Microsoft® Windows® user interface. Communicate with SolidWorks either through the Drop-down menu, Pop-up menu, Shortcut toolbar, Flyout toolbar or the CommandManager. A command is an instruction that informs SolidWorks to perform a task.

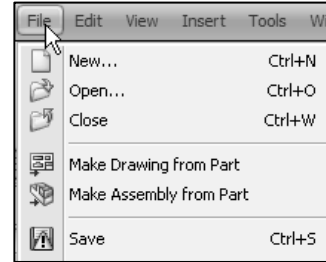

To close a SolidWorks drop-down menu, press the Esc key. You can also click any other part of the SolidWorks Graphics window, or click another drop-down menu.

Right-click Pop-up menus

Right-click in the Graphics window on a model, or in the FeatureManager on a feature or sketch to display a Context-sensitive toolbar. If you are in the middle of a command, this toolbar displays a list of options specifically related to that command.

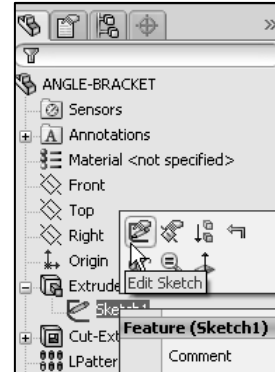

Consolidated toolbar

Similar commands are grouped together in the CommandManager. Example: Variations of the Rectangle sketch tool are grouped in a single fly-out button as illustrated.

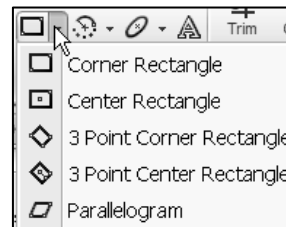

If you select the Consolidated toolbar button without expanding:

- For some commands such as Sketch, the most commonly used command is performed. This command is the first listed and the command shown on the button.

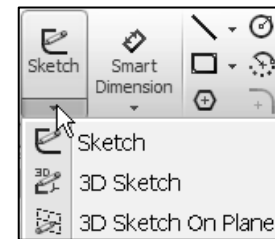

For commands such as rectangle, where you may want to repeatedly create the same variant of the rectangle, the last used command is performed. This is the highlighted command when the Consolidated toolbar is expanded.

System feedback

SolidWorks provides system feedback by attaching a symbol to the mouse pointer cursor. The system feedback symbol indicates what you are selecting or what the system is expecting you to select.

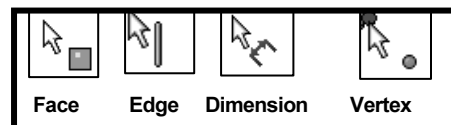

As you move the mouse pointer across your model, system feedback is provided to you in the form of symbols, riding next to the cursor arrow as illustrated.

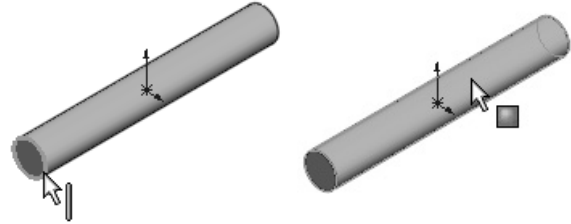

Confirmation Corner

When numerous SolidWorks commands are active, a symbol or a set of symbols are displayed in the upper right corner of the Graphics window. This area is called the Confirmation Corner.

When a sketch is active, the confirmation corner box displays two symbols. The first symbol is the sketch tool icon. The second symbol is a large red X. These three symbols supply a visual reminder that you are in an active sketch. Click the sketch symbol to exit the sketch and to saves any changes that you made.

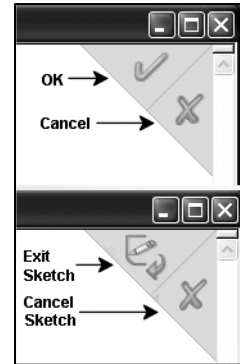

When other commands are active, the confirmation corner box provides a green check mark and a large red X. Click the green check mark to execute the current command. Click the large red X to cancel the command.

Heads-up View toolbar

SolidWorks provides the user with numerous view options from the Standard Views, View, and Heads-up View toolbar.



The Heads-up View toolbar is a transparent toolbar that is displayed in the Graphics window when a document is active. You can't hide nor move the Heads-up View toolbar. The following views are available:

Views are document dependent.



For an active Part or assembly document





For an active drawing document

- *Zoom to Fit* : Zooms the model to fit the Graphics window.
- *Zoom to Area* : Zooms to the areas you select with a bounding box.
- *Previous View* : Displays the previous view.
- *Section View* : Displays a cutaway of a part or assembly, using one or more cross section planes.

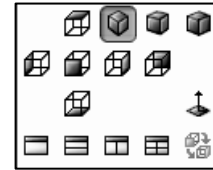
- **View Orientation** : Provides the ability to select a view orientation or the number of viewports. The available options are: *Top, Isometric, Trimetric, Dimetric, Left, Front, Right, Back, Bottom, Single view, Two view - Horizontal, Two view - Vertical, Four view.*



- **Display Style** : Provides the ability to display the style for the active view. The available options are: *Wireframe, Hidden Lines Visible, Hidden Lines Removed, Shaded, Shaded With Edges.*

- **Hide/Show Items** : Provides the ability to select items to hide or show in the Graphics window. Note: The available items are document dependent.

- **Edit Appearance** : Provides the ability to apply appearances from the Appearances PropertyManager.

- **Apply Scene** : Provides the ability to apply a scene to an active part or assembly document. View the available options.



- **View Setting** : Provides the ability to select the following: *RealView Graphics, Shadows in Shaded Mode, and Perspective.*

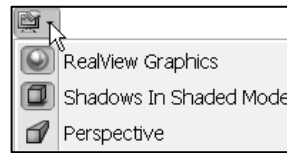

- **Rotate** : Provides the ability to rotate a drawing view.

- **3D Drawing View** : Provides the ability to dynamically manipulate the drawing view to make a selection.



To deactivate the reference planes for an active document, click **View**, uncheck **Planes** from the Menu bar. To deactivate the grid, click **Options** , **Document Properties** tab. Click **Grid/Snaps**, uncheck the **Display grid** box.



To deactivate a single reference plane in an active document, right-click the **selected plane**, click **Hide**.



Modify the Heads-up View toolbar. Press the **space** key. The Orientation dialog box is display.

Click the **New View**  tool. The Name View dialog box is displayed. Enter a new **named** view. Click **OK**. The new view is displayed in the Heads-up View toolbar

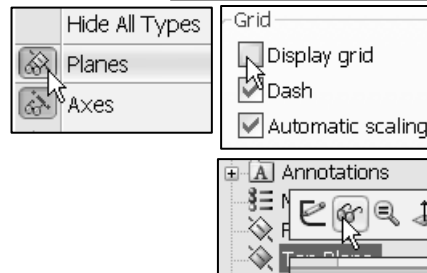

CommandManager

The CommandManager is document dependent. Drop-down tabs are located on the bottom left side of the CommandManager and display the available toolbars and features for each corresponding tab.

The default Part tabs are: *Features*, *Sketch*, *Evaluate*, *DimXpert*, and *Office Products*. Below is an illustrated CommandManager for a default Part document.

 The Office Products toolbar display is dependent on the activated Add-Ins during a SolidWorks session.

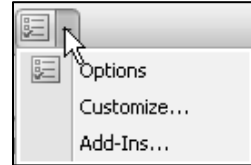

 If you have SolidWorks, SolidWorks Professional, or SolidWorks Premium, the Office Products tab is displayed in the CommandManager.

 Instant3D and Rapid Sketch are activated by default.

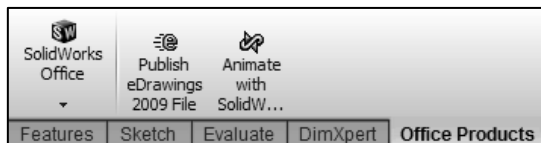
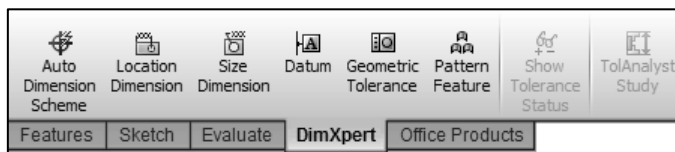
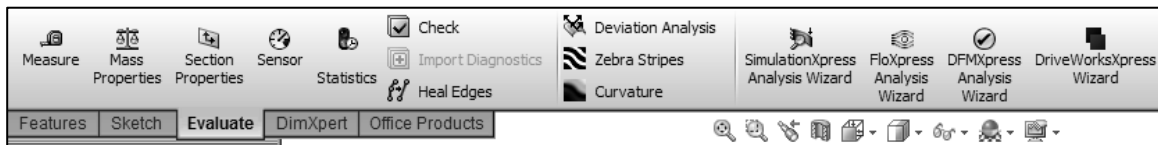
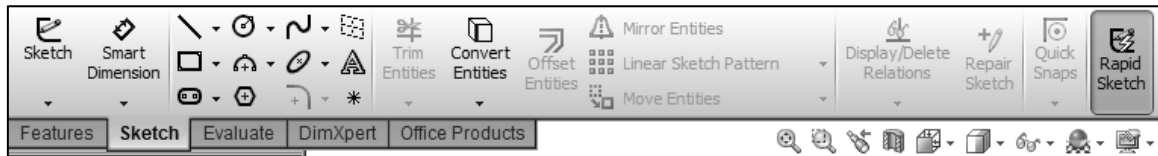
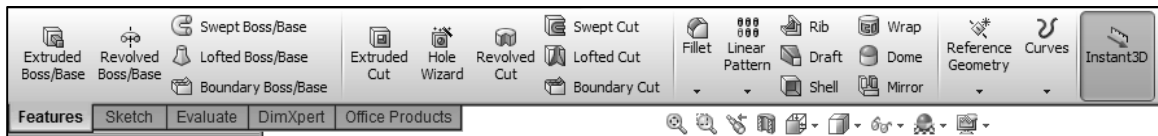



The CommandManager tabs that are displayed are document dependent and can be work flow customize. To customize the CommandManager tabs, **right-click** on a tab, and select the required **custom** option or select **Customize CommandManager** to access the Customize dialog box.

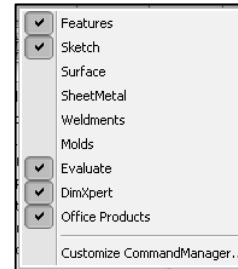

DimXpert provides the ability to graphically check if the model is fully dimensioned and toleranced. DimXpert automatically recognize manufacturing features. Manufacturing features are *not SolidWorks features*. Manufacturing features are defined in 1.1.12 of the ASME Y14.5M-1994 Dimensioning and Tolerancing standard. See SolidWorks Help for additional information.

FeatureManager Design Tree

The FeatureManager design tree is located on the left side of the SolidWorks Graphics window. The design tree provides a summarize view of the active part, assembly, or drawing document. The tree displays the details on how the part, assembly, or drawing document is created.

Understand the FeatureManager design tree to troubleshoot your model. The FeatureManager is use extensively throughout this book.

The FeatureManager consist of four default tabs:

- *FeatureManager design tree*
- *PropertyManager*
- *ConfigurationManager*
- *DimXertManager*

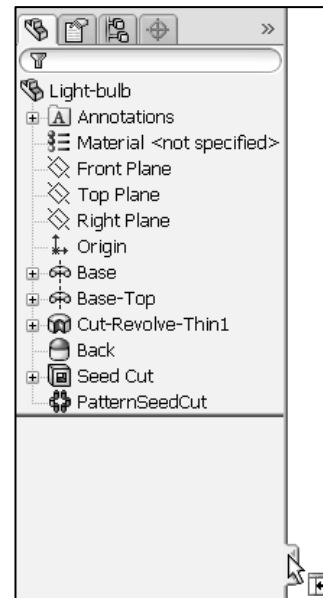

Select the Hide FeatureManager Tree Area arrows tab





from the FeatureManager to enlarge the Graphics window for modeling.



The Sensors tool  Sensors located in the FeatureManager monitors selected properties in a part or assembly and alerts you when values deviate from the specified limits. There are four sensor types: *Mass properties*, *Measurement*, *Interference Detection*, and *Simulation data*.



Various commands provide the ability to control what is displayed in the FeatureManager design tree. They are:

1. Show or Hide FeatureManager items.

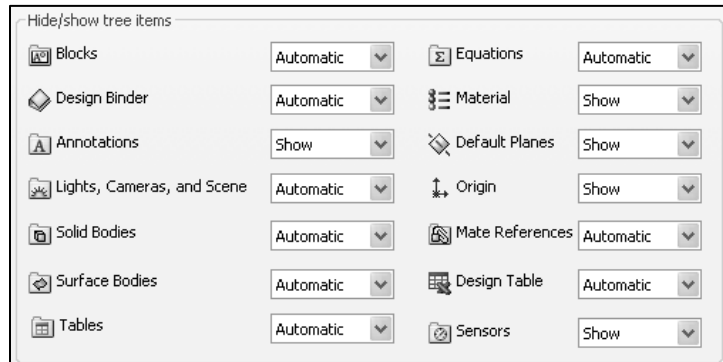
 Click **Options**  from the Menu bar. Click **FeatureManager** from the System Options tab. **Customize** your FeatureManager from the Hide/Show Tree Items dialog box.



2. Filter the FeatureManager design tree. Enter information in the filter field. You can filter by: *Type of features, Feature names, Sketches, Folders, Mates, User-defined tags, and Custom properties.*

 Tags are keywords you can add to a SolidWorks document to make them easier to filter and to search. The Tags  icon is located in the bottom right corner of the Graphics window.

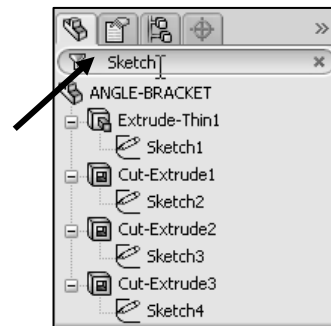

 To collapse all items in the FeatureManager, **right-click** and select **Collapse items**, or press the **Shift +C** keys.



The FeatureManager design tree and the Graphics window are dynamically linked. Select sketches, features, drawing views, and construction geometry in either pane.

Split the FeatureManager design tree and either display two FeatureManager instances, or combine the FeatureManager design tree with the ConfigurationManager or PropertyManager.

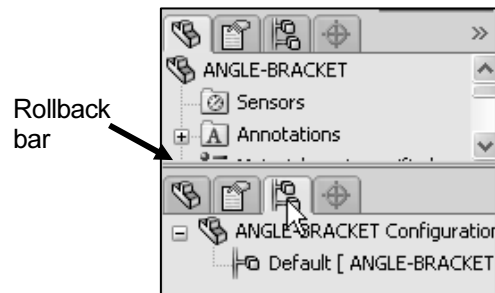





Move between the FeatureManager design tree, PropertyManager, ConfigurationManager, and DimXpertManager by selecting the tabs at the top of the menu.

 Press the **s** key to view/access previous command tools in the Graphics window.

Split the ConfigurationManager and either display two ConfigurationManager instances, or combine the ConfigurationManager with the FeatureManager design tree, PropertyManager, or a third party application that uses the panel.

The icons in the ConfigurationManager denote whether the configuration was created manually or with a design table.

The DimXpertManager tab provides the ability to insert dimensions and tolerances manually or automatically. The DimXpertManager provides the following selections: *Auto Dimension Scheme* , *Show Tolerance Status* , *Copy Scheme* , and *TolAnalyst Study* .





Fly-out FeatureManager

The fly-out FeatureManager design tree provides the ability to view and select items in the PropertyManager and the FeatureManager design tree at the same time.

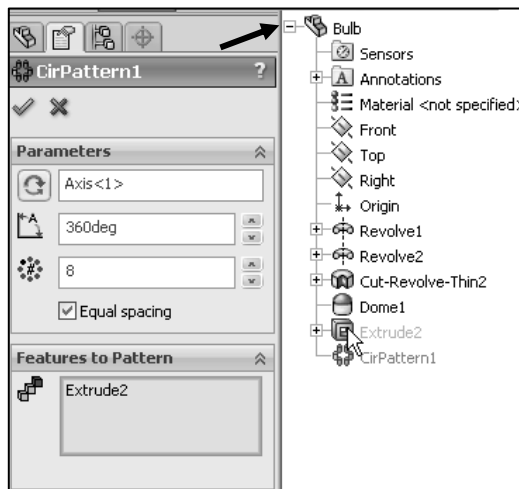
Throughout the book, you will select commands and command options from the drop-down menu, fly-out FeatureManager, Context toolbar, or from a SolidWorks toolbar.



 Another method for accessing a command is to use the accelerator key. Accelerator keys are special keystrokes which activates the drop-down menu options. Some commands in the menu bar and items in the drop-down menus have an underlined character. Press the Alt key followed by the corresponding key to the underlined character activates that command or option.



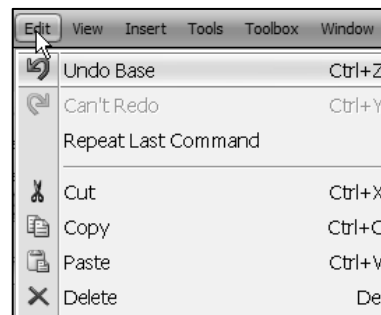

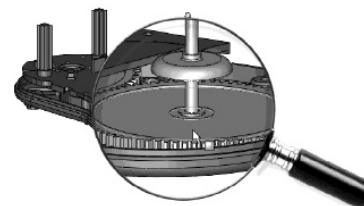

 Press the **g** key to activate the Magnifying glass tool. Use the Magnifying glass tool to inspect a model and make selections without changing the overall view.





 Illustrations may vary slightly depending on your SolidWorks version.



Task Pane

The Task Pane is displayed when a SolidWorks session starts. The Task Pane contains the following default tabs: *SolidWorks Resources* , *Design Library* , *File Explorer* , *SolidWorks Search* , *View Palette* , *Appearances/Scenes* , and *Custom Properties* .



 The Document Recovery tab  is displayed in the Task Pane if your system terminates unexpectedly with an active document and if auto-recovery is enabled in the System Options section.

SolidWorks Resources

The basic SolidWorks Resources  menu displays the following default selections: *Getting Started*, *Community*, *Online Resources*, and *Tip of the Day*.

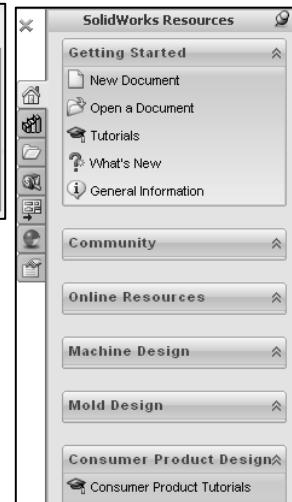
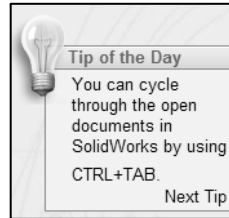



Other user interfaces are available during the initial software installation selection: *Machine Design*, *Mold Design*, or *Consumer Products Design*.

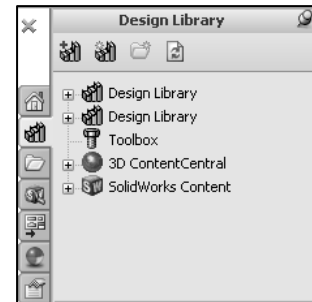

Design Library

The Design Library  contains reusable parts, assemblies, and other elements, including library features.

The Design Library tab contains four default selections. Each default selection contains additional sub categories. The default selections are: *Design Library*, *Toolbox*, *3D ContentCentral*, and *SolidWorks Content*.



 Click **Tools, Add-Ins...**, **SolidWorks Toolbox** and **SolidWorks Toolbox Browser** to activate the SolidWorks Toolbox.

 To access the Design Library folders in a non network environment for an new installation, click **Add File Location** , enter: **C:\Documents and Settings\All Users\Application Data\SolidWorks\SolidWorks 2009\design library**. Click **OK**. In a network environment, contact your IT department for system details.

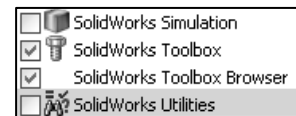

File Explorer

File Explorer  duplicates Windows Explorer from your local computer and displays *Recent Documents*, *directories*, and the *Open in SolidWorks* and *Desktop* folders

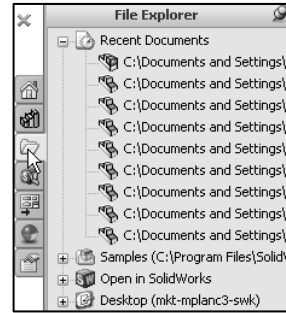

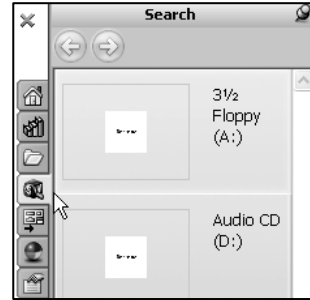
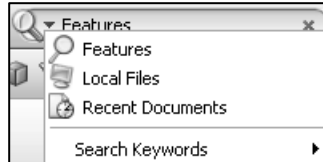

Search

SolidWorks Search  is installed with Microsoft Windows Search and indexes the resources once before searching begins, either after installation, or when you initiate the first search.



The SolidWorks Search box is display in the upper right corner of the SolidWorks Graphics window. Enter the text or key words to search. Click the drop-down arrow to view the last 10 recent searches.

The Search tool  in the Task Pane searches the following default locations: *All Locations*, *Local Files*, *Design Library*, *SolidWorks Toolbox*, and *3D ContentCentral*.

 Select any or all of the above locations. If you do not select a file location, all locations are searched.

View Palette

The View Palette  tool located in the Task Pane provides the ability to insert drawing views of an active document, or click the Browse button to locate the desired document.

Click and drag the view from the View Palette into an active drawing sheet to create a drawing view.

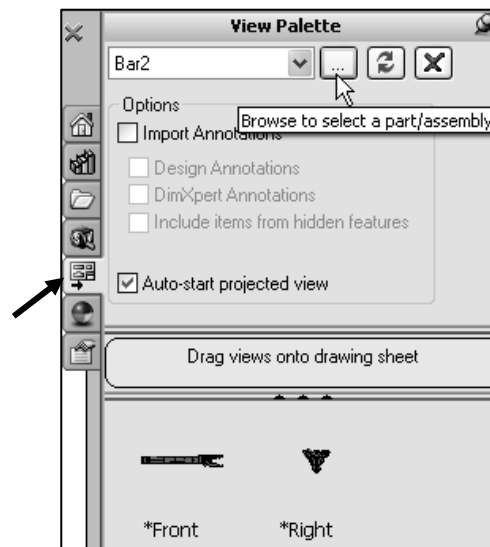

Appearances/Scenes

Appearances/Scenes  provide a simplified way to display models in a photo-realistic setting using a library of Appearances and Scenes. Note: Appearances/Scenes require graphics card support.

 Appearances/Scenes graphics is only available with supported graphics cards. For the latest information on graphics cards that support Appearances/Scenes Graphics display, visit: www.solidworks.com/pages/services/videocardtesting.html.

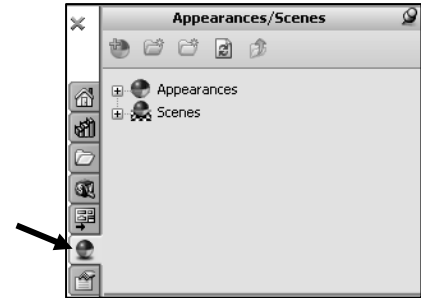

Custom Properties

New in 2009 is the Custom Properties tab located in the Task Pane. The Custom Properties  tool provides the ability to enter custom and configuration specific properties directly into SolidWorks files.

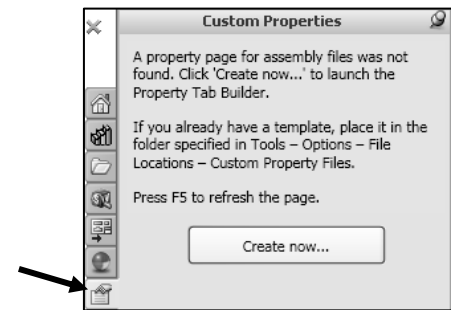

Document Recovery

If auto recovery is initiated in the System Options section and the system terminates unexpectedly with an active document, the saved information files are available on the Task Pane Document Recovery tab the next time you start a SolidWorks session.

Motion Study tab

Motion Studies are graphical simulations of motion for an assembly. Access MotionManager from the Motion Study tab. The Motion Study tab is located in the bottom left corner of the Graphics window.

Incorporate visual properties such as lighting and camera perspective. Click the Motion Study tab to view the MotionManager. Click the Model tab to return to the FeatureManager design tree.

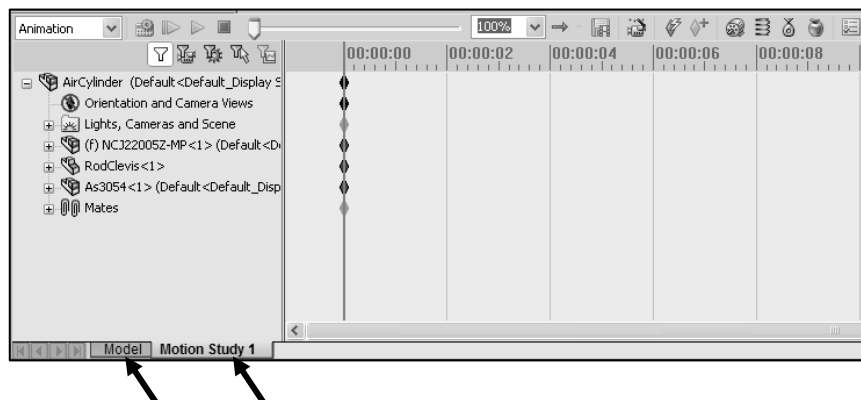

The MotionManager display a timeline-based interface, and provide the following selections from the drop-down menu as illustrated:

Animation: Apply Animation to animate the motion of an assembly. Add a motor and insert positions of assembly components at various times using set key points. Use the Animation option to create animations for motion that does not require accounting for mass or gravity.

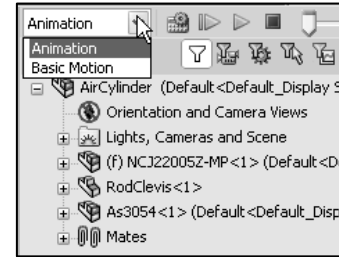

Basic Motion. Apply Basic Motion for approximating the effects of motors, springs, collisions, and gravity on assemblies. Basic Motion takes mass into account in calculating motion. Basic Motion computation is relatively fast, so you can use this for creating presentation animations using physics-based simulations. Use the Basic Motion option to create simulations of motion that account for mass, collisions, or gravity.



To create a new Motion Study, click **Insert, New Motion Study** from the Menu bar.

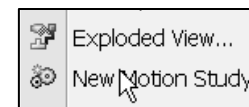

There are two modes in the New SolidWorks Document dialog box: Novice and Advanced. The Novice option is the default option with three templates. The Advanced option contains access to more templates.

Activity: Create a new Part

A part is a 3D model which consists of features. What are features?

- Features are geometry building blocks.
- Features add or remove material.
- Features are created from 2D or 3D sketched profiles or from edges and faces of existing geometry.
- Features are an individual shape that combined with other features, makes up a part or assembly. Some features, such as bosses and cuts, originate as sketches. Other features, such as shells and fillets, modify a feature's geometry.
- Features are displayed in the FeatureManager as illustrated.



You can suppress a feature, as is *Flat-Pattern1* in the Bent Bar FeatureManager. A suppress feature is display in light gray.

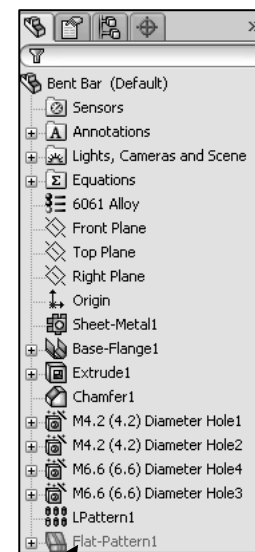

 The first sketch of a part is the Base sketch. The Base sketch is the foundation for the 3D model.

Create a new part.

- 6) Click **New**  from the Menu bar. The New SolidWorks Document dialog box is displayed.

Select Advanced Mode.

- 7) Click the **Advanced** button to display the New SolidWorks Document dialog box in Advance mode.
- 8) The Templates tab is the default tab. Part is the default template from the New SolidWorks Document dialog box. Click **OK**.

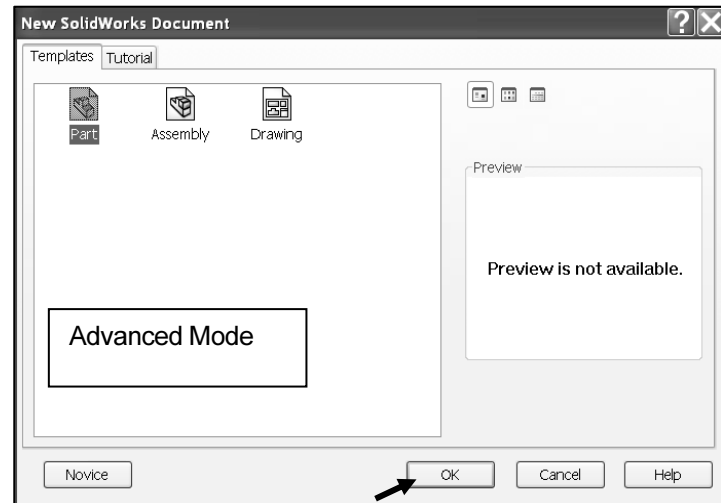
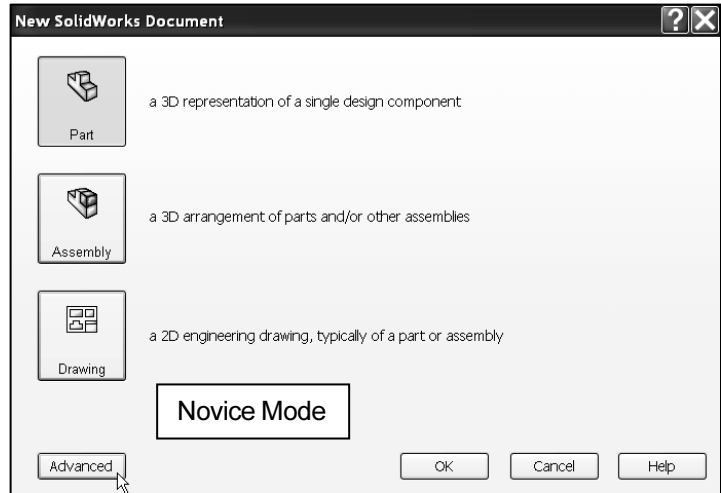

The Advanced mode remains selected for all new documents in the current SolidWorks session. When you exit SolidWorks, the Advanced mode setting is saved.

The default SolidWorks installation contains two tabs in the New SolidWorks Document dialog box: Templates and Tutorial.

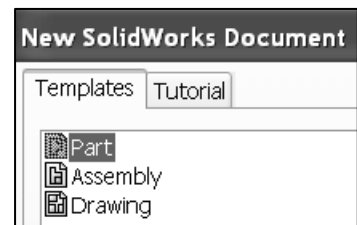

The Templates tab corresponds to the default SolidWorks templates.

The Tutorial tab corresponds to the templates utilized in the SolidWorks Online Tutorials.



Part1 is displayed in the FeatureManager and is the name of the document. Part1 is the default part window name. The Menu bar, CommandManager, FeatureManager, Heads-up View toolbar, SolidWorks Resources, SolidWorks Search, Task Pane, and the Origin are displayed in the Graphics window.

The Origin  is displayed in blue in the center of the Graphics window. The Origin represents the intersection of the three default reference planes: *Front Plane*, *Top Plane*, and *Right Plane*. The positive X-axis is horizontal and points to the right of the Origin in the Front view. The positive Y-axis is vertical and point upward in the Front view. The FeatureManager contains a list of features, reference geometry, and settings utilized in the part.

 The Tags  icon is displayed in the bottom right corner of the Graphics window. Tags are keywords you add to SolidWorks documents and features to make them easier to filter and search for.

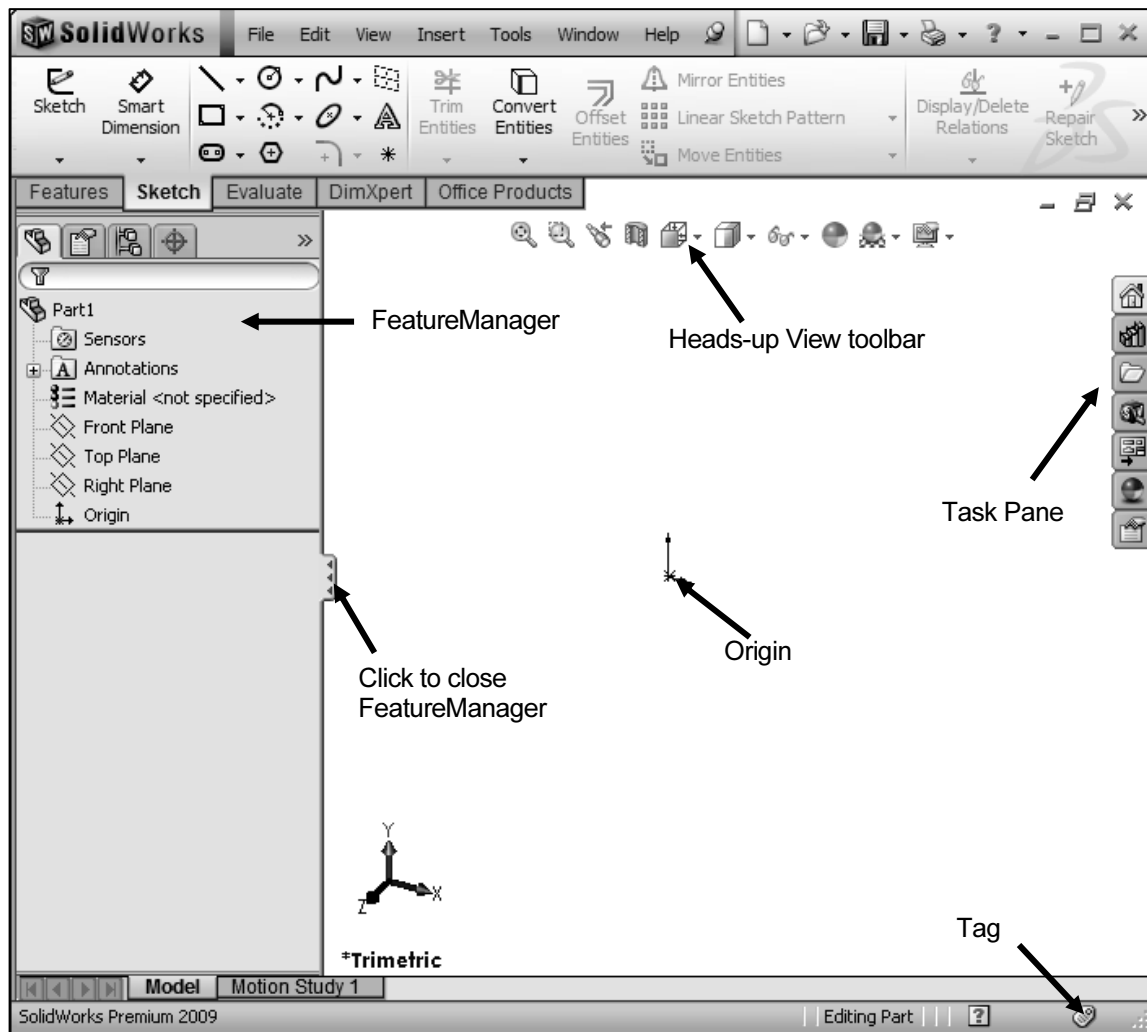

 In the book, Reference planes and Grid/Snaps are deactivated in the Graphics window to improve model clarity.

The CommandManager is document dependent. The tabs are located on the bottom left side of the CommandManager and display the available toolbars and features for each corresponding tab. The default tabs for a Part are: *Features*, *Sketch*, *Evaluate*, *DimXpert*, and *Office Products*.

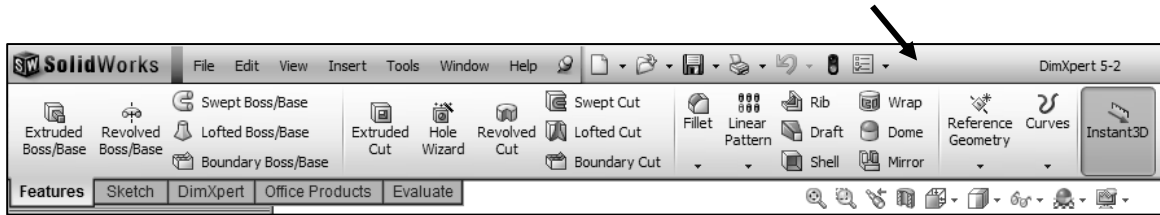

 The Features icon and Features toolbar should be selected by default in Part mode.

The CommandManager is utilized in this text. Control the CommandManager display.

Right-click in the gray area to the right of the Options  icon in the Menu bar toolbar. A complete list of toolbars is displayed. Check CommandManager if required.

 Another way to display a toolbar, click **View, Toolbars** from the Menu bar menu. Select the required toolbar.

Select individual toolbars from the View, Toolbars list to display in the Graphics window. Reposition toolbars by clicking and dragging.

 Click **View, Origins** from the Menu bar menu to display the Origin in the Graphics window.

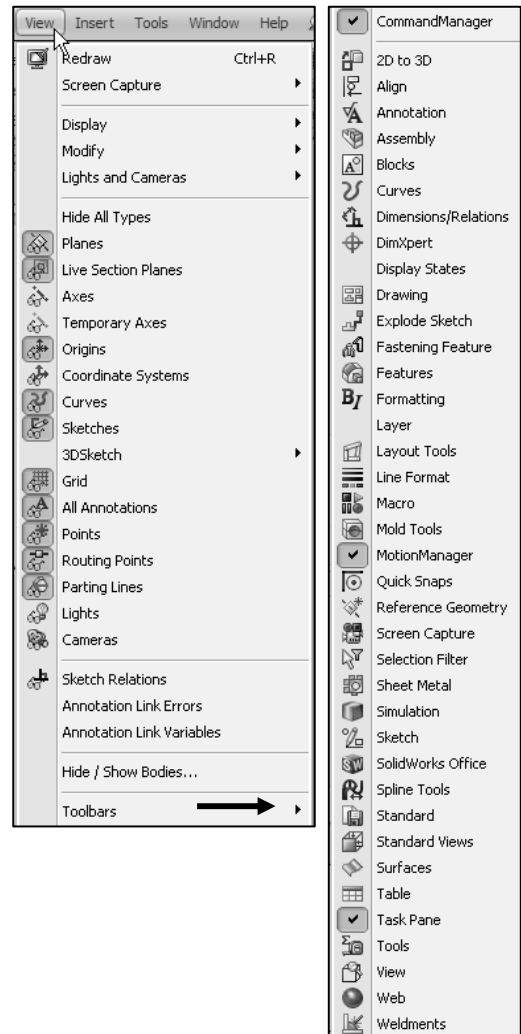



Activity: Create the AXLE Part

Set the Menu bar toolbar and Menu bar menu.

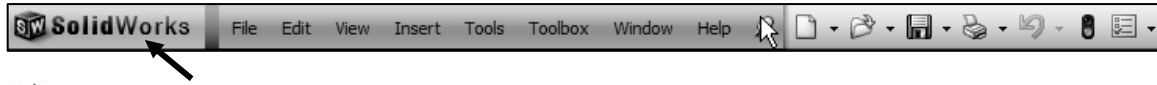
- 9) Click **SolidWorks** to expand the Menu bar menu.
- 10) Pin  the Menu bar as illustrated. Use both the Menu bar menu and the Menu bar toolbar in this book.



 The SolidWorks Help Topics contains step-by-step instructions for various commands. The Help  icon is displayed in the dialog box or in the PropertyManager for each feature.

Set the Document Properties.

- 11) Click **Options**  from the Menu bar. The System Options General dialog box is displayed
- 12) Click the **Document Properties** tab.
- 13) Select **ANSI** from the Overall drafting standard drop-down menu. Various Detailing options are available depending on the selected standard.

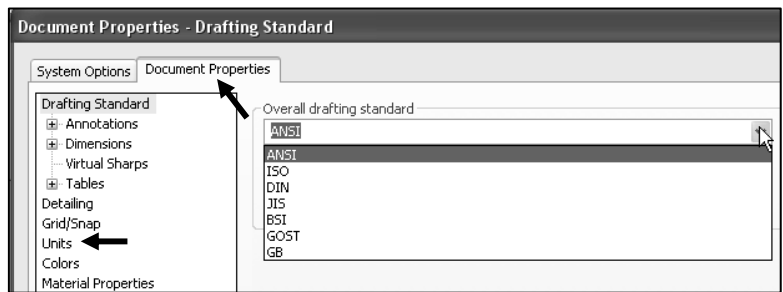
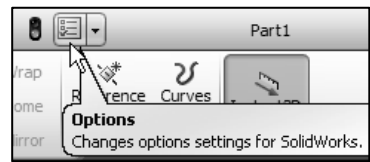

 Various detailing options are available depending on the selected standard.

The Overall drafting standard determines the display of dimension text, arrows, symbols, and spacing. Units are the measurement of physical quantities. Millimeter dimensioning and decimal inch dimensioning are the two most common unit types specified for engineering parts and drawings.

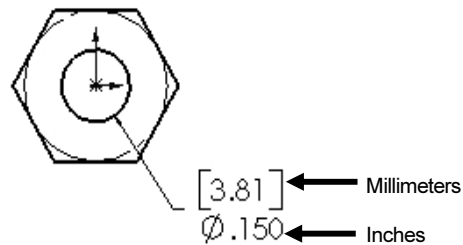

The primary units in this book are provided in IPS, (inch, pound, seconds). The optional secondary units are provided in MMGS, (millimeters, grams, second) and are indicated in brackets [].

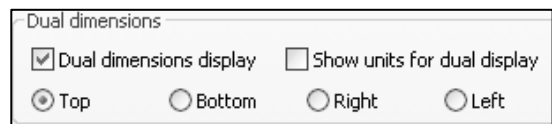
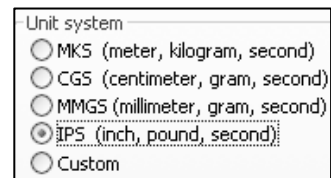



Illustrations are provided in both inches and millimeters.

Set the document units.

- 14) Click **Units**.
- 15) Click **IPS** (inch, pound, second) [MMGS] for Unit system.
- 16) Select **.123, [.12]** (three decimal places) for Length basic units.
- 17) Select **None** for Angle decimal places.
- 18) Click **OK** from the Document Properties - Units dialog box. The Part FeatureManager is displayed.

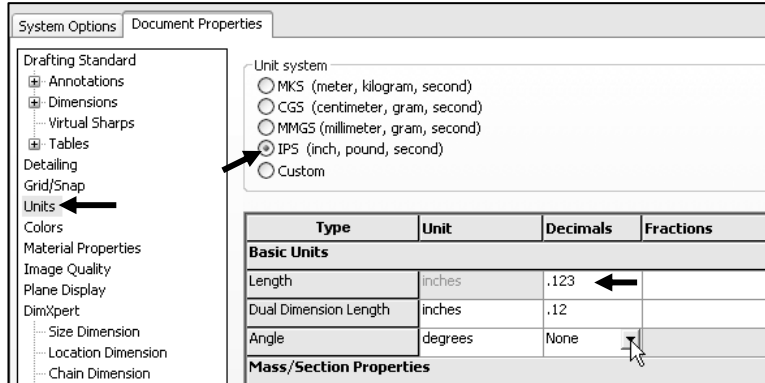

Activity: AXLE Part-Extruded Base Feature

Insert a new sketch for the Extruded Base feature.

- 19) Right-click **Front Plane** from the FeatureManager. This is your Sketch plane. The Context toolbar is displayed.
- 20) Click **Sketch** from the Context toolbar as illustrated.

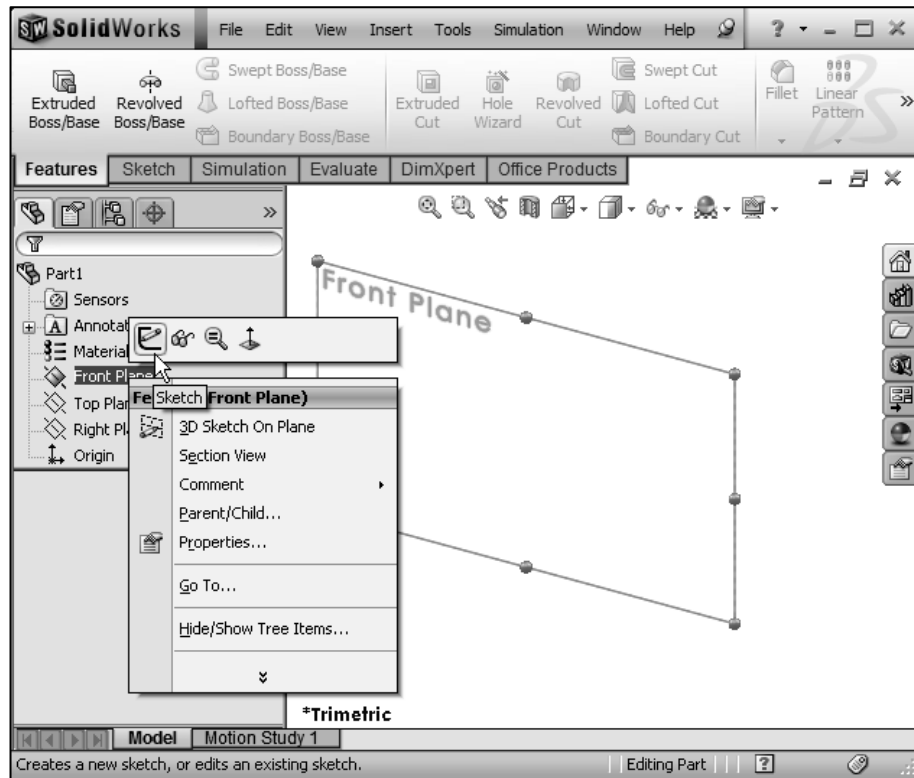

The Sketch toolbar is displayed. Front Plane is your Sketch plane. Note: the grid is deactivated for picture clarity.



You can also click the Front Plane from the FeatureManager and click the Sketch tab from the CommandManager.

- 21) Click the **Circle** tool from the Sketch toolbar. The Circle PropertyManager is displayed.

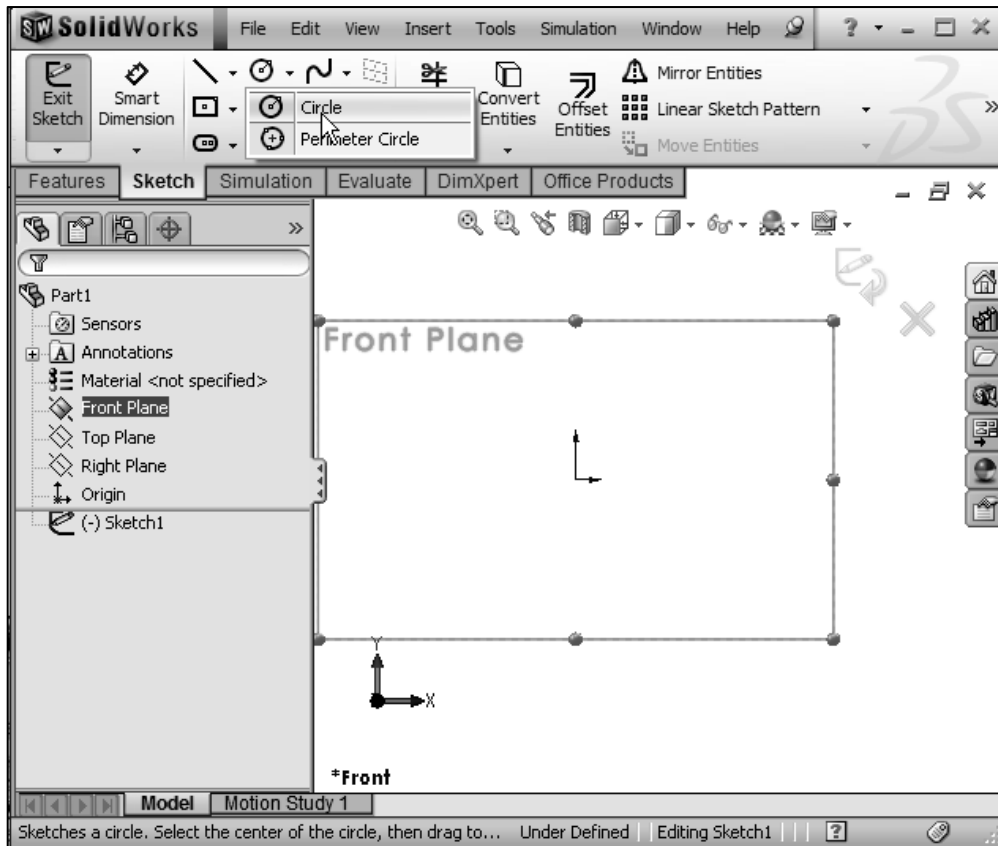

The Circle-based tool uses a Consolidated Circle PropertyManager. The SolidWorks application defaults to the last used tool type.

- 22) Drag the **mouse pointer** into the Graphics window. The cursor displays the Circle icon symbol.

- 23) Click the **Origin** of the circle. The cursor displays the Coincident to point feedback symbol.

- 24) Drag the **mouse pointer** to the right of the Origin to create the circle as illustrated. The center point of the circle is positioned at the Origin.

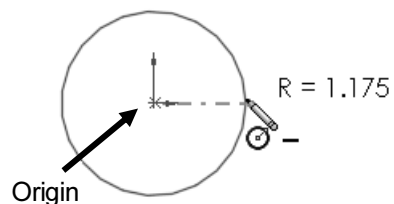

- 25) Click a **position** to create the circle. The activated circle is displayed in blue.

Add a dimension.

- 26) Click **Smart Dimension**  from the Sketch toolbar. The cursor displays the Smart Dimension icon

Dimension icon .

- 27) Click the **circumference** of the circle.



- 28) Click a **position** diagonally above the circle in the Graphics window.

- 29) Enter .188in, [4.78] in the Modify dialog box.

- 30) Click the **Green Check mark**  in the Modify dialog box. The diameter of the circle is .188 inches.

 If required, click the blue arrow head dots to toggle the direction of the dimension arrow.

The circular sketch is centered at the Origin. The dimension indicates the diameter of the circle.

 If your sketch is not correct, select the Undo  tool.

 To fit your sketch to the Graphics window, press the f key.

Extrude the sketch to create the Extruded Base Feature.

- 31) Click the **Features** tab from the CommandManager.

- 32) Click the **Extruded Boss/Base**  Features tool. The Extrude PropertyManager is displayed. Blind is the default End Condition in Direction 1.

- 33) Select **Mid Plane** for End Condition in Direction 1.

- 34) Enter 1.375in, [34.93] for Depth in Direction 1. Accept the default conditions.

- 35) Click **OK**  from the Extrude PropertyManager. Extrude1 is displayed in the FeatureManager.

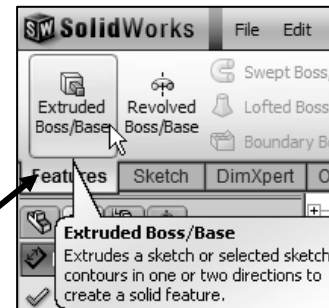
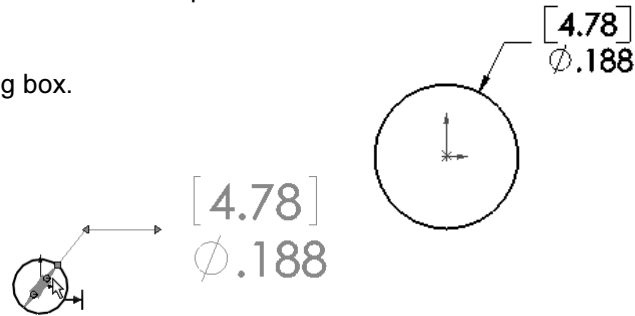
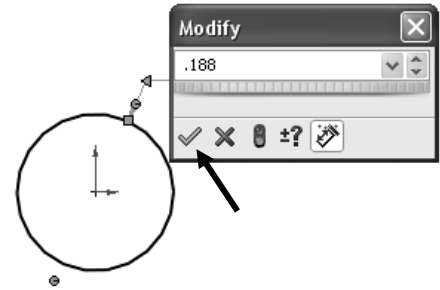

Fit the model to the Graphics window.

- 36) Press the **f** key. Note the location of the Origin in the model.

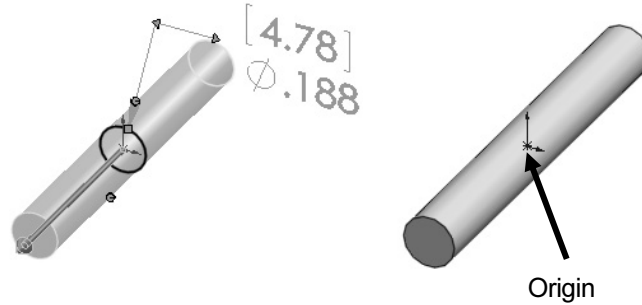

The Extrude PropertyManager displays the parameters utilized to define the feature. The Mid Plane End Condition in the Direction 1 box extrudes the sketch equally on both sides of the Sketch plane. The depth defines the extrude distance.

The Extrude1 feature name is displayed in the FeatureManager. The FeatureManager lists the features, planes, and other geometry that construct the part. Extrude features add material. Extrude features require the following: *Sketch plane*, *Sketch*, and *depth*.

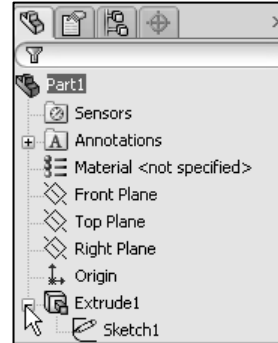

The Sketch plane is the Front Plane. The Sketch is a circle with the diameter of .188in, [4.76]. The Depth is 1.375in, [34.93].

Activity: AXLE Part-Save

Save the part.

- 37) Click **Save As** from the Menu bar.
- 38) Double-click the **MY-DOCUMENTS** file folder.
- 39) Click the **Create New Folder** icon.
- 40) Enter **SW-TUTORIAL-2009** for the file folder name.
- 41) Double-click the **SW-TUTORIAL-2009** file folder. SW-TUTORIAL-2009 is the Save in file folder name.
- 42) Enter **AXLE** for the File name.
- 43) Enter **AXLE ROD** for the Description.

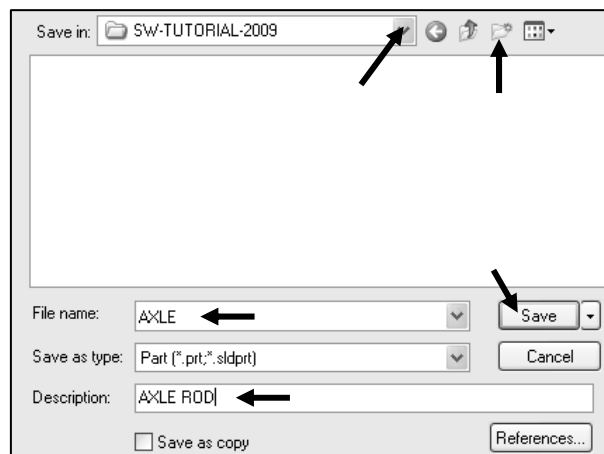
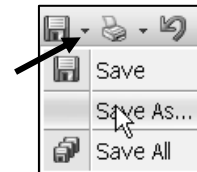



44) Click **Save**. The AXLE FeatureManager is displayed.

 Organize parts into file folders. The file folder for this project is named: SW-TUTORIAL-2009. Save all documents in the SW-TUTORIAL-2009 file folder.

 Copy all files from the CD in the book to the SW-TUTORIAL-2009 folder.

Activity: AXLE Part-Edit Color

Modify the color of the part.

- 45) Right-click the **AXLE**  icon at the top of the FeatureManager.
- 46) Click the **Appearances** drop down arrow.
- 47) Click the **Appearance** box as illustrated. The Appearances PropertyManager is displayed. AXLE is displayed in the Selection box.
- 48) Select a **light blue** color from the Color box.
- 49) Click **OK**  from the Color And Optics PropertyManager. View the AXLE in the Graphics window.

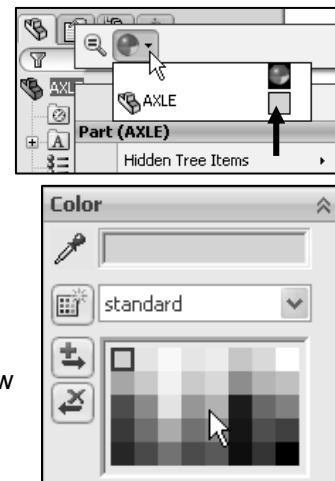

The SolidWorks FeatureManager design tree provides an indicator informing you on the status of your sketch. The sketch can either be:

- 1.) (+) *Over defined*. The sketch is displayed in red.
- 2.) (-) *Under defined*. The sketch is displayed in blue.
- 3.) (?) *Cannot be solved*.
- 4.) *No prefix*. The sketch is fully defined. This is the ideal state. A fully defined sketch has complete information and is displayed in black.

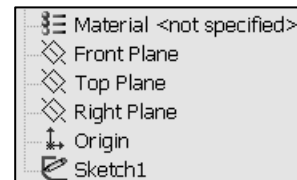
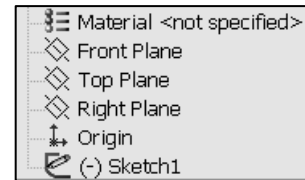
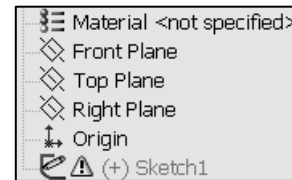

 The SketchXpert PropertyManager provides the ability to diagnose an over defined sketch to create a fully defined sketch.

If you have an over defined sketch, click Over Defined at the bottom of the Graphics window toolbar. The SketchXpert PropertyManager is displayed. Click the Diagnose button.

Select the desired solution and click the Accept button from the Results box.



Activity: AXLE Part-View Modes

Orthographic projection is the process of projecting views onto Parallel planes with \perp projectors.

The default reference planes are the Front, Top and Right Planes.

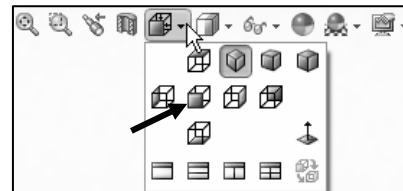

The Isometric view displays the part in 3D with two equal projection angles.

 The Heads-up View toolbar illustration may vary depending on your SolidWorks release version.

Display the various view modes using the Heads-up View toolbar.

50) Click **Front view**  from the Heads-up View toolbar.

51) Click **Top view**  from the Heads-up View toolbar.

52) Click **Right view**  from the Heads-up View toolbar.

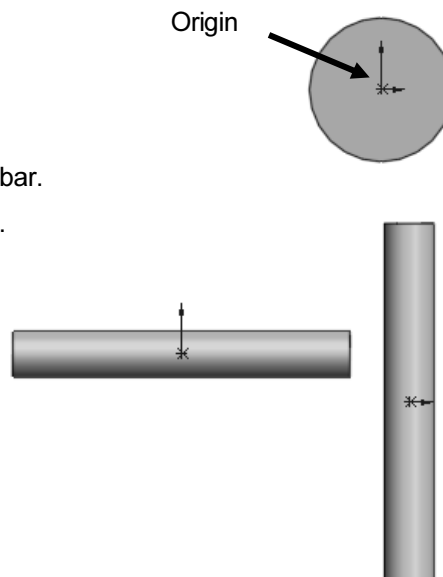

53) Click **Isometric view**  from the Heads-up View toolbar.

 View modes manipulate the model in the Graphics window.

Display the various View modes.

54) Press the lower case **z** key to zoom out.

55) Press the upper case **Z** key to zoom in.

56) Click **Zoom to Fit**  to display the full size of the part in the current window.

57) **Right-click** in the Graphics window. View the available view tools.

58) Click **inside** the Graphics window.

Rotate the model.

59) Click the **middle mouse** button and move your mouse. The model rotates. The Rotate icon  is displayed.

60) Press the **up arrow** on your key board. The arrow keys rotate the model in 15 degree increments.



 View modes remain active until deactivated from the View toolbar or unchecked from the pop-up menu.

 Utilize the center wheel of the mouse to Zoom In/Zoom Out and Rotate the model in the Graphics window.



View the various Display Styles.

61) Click **Isometric view**  from the Heads-up View toolbar.

62) Click the **drop down arrow** from the Display Styles box from the Heads-up Views toolbar as illustrated. SolidWorks provides five key Display Styles:

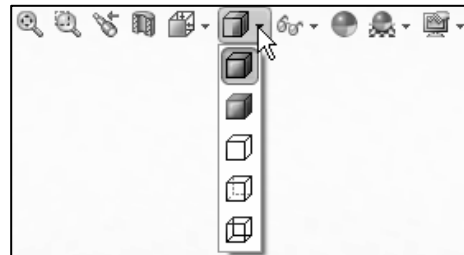
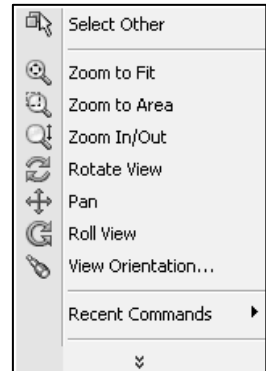
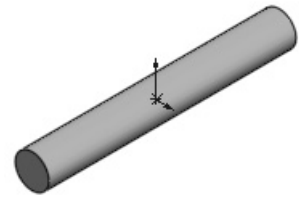
- *Shaded* . Displays a shaded view of the model with no edges.
- *Shaded With Edges* . Displays a shaded view of the model, with edges.



- *Hidden Lines Removed* . Displays only those model edges that can be seen from the current view orientation.
- *Hidden Lines Visible* . Displays all edges of the model. Edges that are hidden from the current view are displayed in a different color or font.
- *Wireframe* . Displays all edges of the model.

Save the AXLE part.

63) Click **Save** . The AXLE part is complete.



Review the AXLE Part

The AXLE part utilized an Extruded Base feature. The Extruded Base feature adds material. The Extruded feature required a Sketch plane, sketch, and depth. The AXLE Sketch plane was the Front Plane. The 2D circle was sketched centered at the Origin. A dimension defined the overall size of the sketch based on the dimensions of mating parts in the LINKAGE assembly.

The name of the feature is Extrude1. Extrude1 utilized the Mid Plane End Condition. The Extrude1 feature is symmetrical about the Front plane.

The Edit Color option modified the part color. Select the Part icon in the FeatureManager to modify the color of the part. Color and a prefix defines the sketch status. A blue sketch is under defined. A black sketch is fully defined. A red sketch is over defined.

The default Reference planes are the Front, Top, and Right Planes. Utilize the Heads-up View toolbar to display the principle views of a part. The View Orientation and Display Style tools manipulate the model in the Graphics windows.

 Instant3D provides the ability to click and drag geometry and dimension manipulator points to resize features in the Graphics window, and to use on-screen rulers to measure modifications. In this book, you will primarily use the PropertyManager and dialog boxes to create and modify model dimensions.

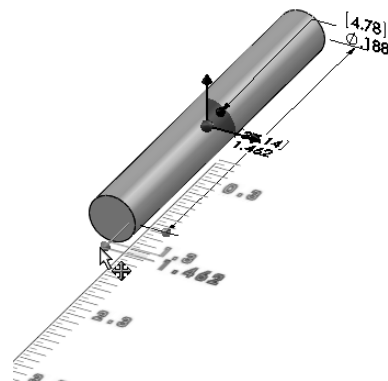
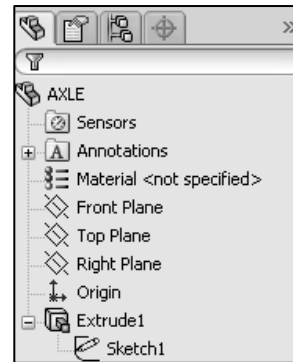

SHAFT-COLLAR Part

The SHAFT-COLLAR part is a hardened steel ring fastened to the AXLE part.

Two SHAFT-COLLAR parts are used to position the two FLATBAR parts on the AXLE.

Create the SHAFT-COLLAR part.

Utilize the Extruded Base  feature. The Extruded Base feature requires a 2D circular profile.

Utilize symmetry. Sketch a circle on the Front Plane centered at the Origin.

Extrude the sketch with the Mid Plane End Condition. The Extruded Base feature is centered on both sides of the Front Plane.

The Extruded Cut  feature removes material. Utilize an Extruded Cut feature to create a hole. The Extruded Cut feature requires a 2D circular profile. Sketch a circle on the front face centered at the Origin.

The Through All End Condition extends the Extruded Cut feature from the front face through all existing geometry.

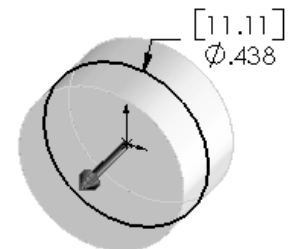
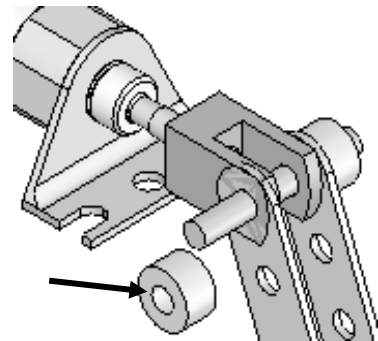

SHAFT-COLLAR

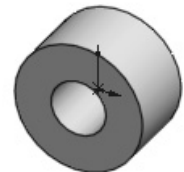

Activity: SHAFT-COLLAR Part-Extruded Base Feature

Create a new part.

64) Click **New**  from the Menu bar. The New SolidWorks Document dialog box is displayed. The Templates tab is the default tab. Part is the default template from the New SolidWorks Document dialog box.

65) Double-click **Part**. The Part FeatureManager is displayed.

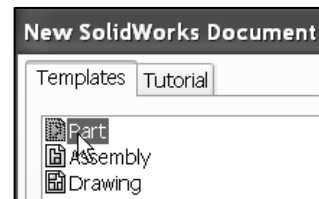

Save the part.

66) Click **Save As** from the Menu bar.

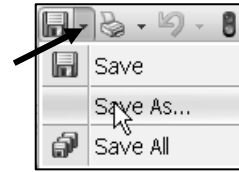

67) Enter **SHAFT-COLLAR** for File name in the SW-TUTORIAL-2009 folder.

68) Enter **SHAFT-COLLAR** for Description.

69) Click **Save**. The SHAFT-COLLAR FeatureManager is displayed.

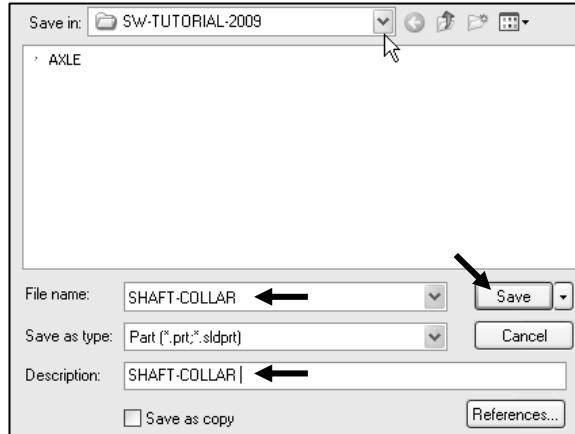

Set the Dimension standard and part units.

70) Click **Options**, **Document Properties** tab from the Menu bar.

71) Select **ANSI** from the Overall drafting standard drop-down menu.

72) Click **Units**.

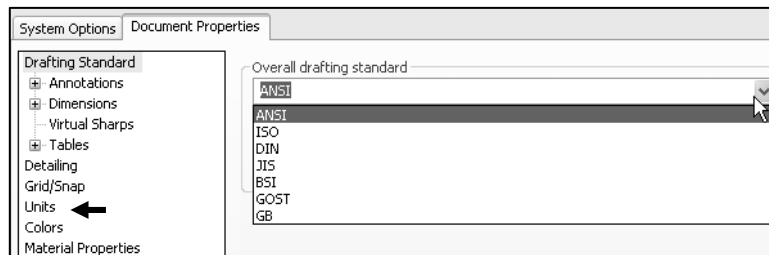



73) Click **IPS** (inch, pound, second), **[MMGS]** for Unit system.

74) Select **.123, [.12]** (three decimal places) for Length units Decimal places.

75) Select **None** for Angular units Decimal places.

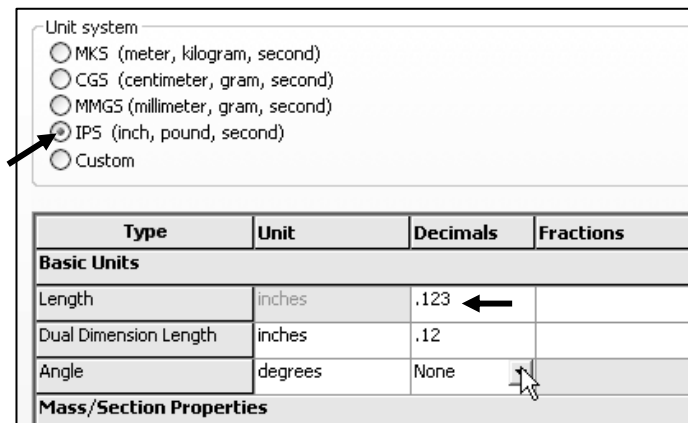
76) Click **OK** from the Document Properties - Units dialog box.



 To view the Origin, click **View, Origins** from the Menu bar menu.

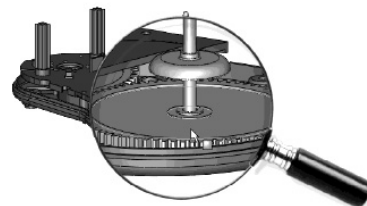

 Press the **g** key to activate the Magnifying glass tool. Use the Magnifying glass tool to inspect a model and make selections without changing the overall view.



Insert a new sketch for the Extruded Base feature.

77) Right-click **Front Plane** from the FeatureManager. This is the Sketch plane. The Context toolbar is displayed.

78) Click **Sketch**  from the Context toolbar as illustrated. The Sketch toolbar is displayed.

79) Click the **Circle**  tool from the Sketch toolbar. The Circle PropertyManager is displayed. The cursor displays the Circle icon symbol .

80) Click the **Origin** . The cursor displays the Coincident to point feedback symbol.

81) Drag the **mouse pointer** to the right of the Origin as illustrated.

82) Click a **position** to create the circle.

Add a dimension.

83) Click **Smart Dimension**  from the Sketch toolbar. Click the **circumference** of the circle. The cursor displays the diameter feedback symbol.

84) Click a **position** diagonally above the circle in the Graphics window.

85) Enter **.4375in, [11.11]** in the Modify dialog box.

86) Click the **Green Check mark**  in the Modify dialog box. The black sketch is fully defined.

Note: Three decimal places are displayed. The diameter value .4375 rounds to .438.

Extrude the sketch to create the Base feature.

87) Click the **Features** tab from the CommandManager.

88) Click the **Extruded Boss/Base**  features tool. The Extrude PropertyManager is displayed.

89) Select **Mid Plane** for End Condition in Direction 1. Enter **.250in, [6.35]** for Depth. Accept the default conditions. Note the location of the Origin.

90) Click **OK**  from the Extrude PropertyManager. Extrude1 is displayed in the FeatureManager.

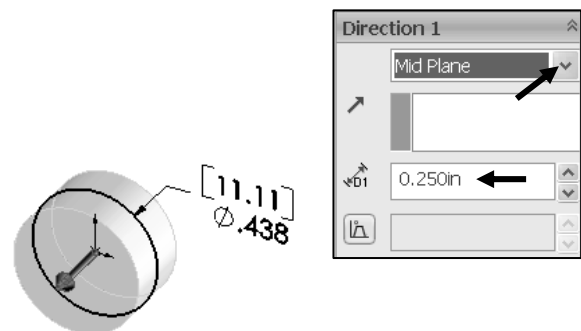
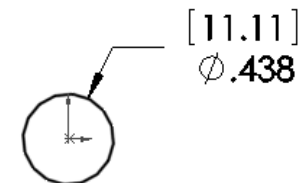
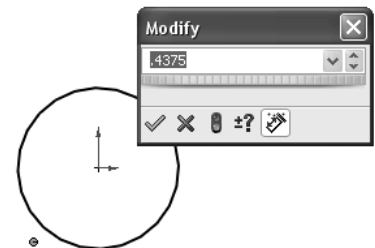
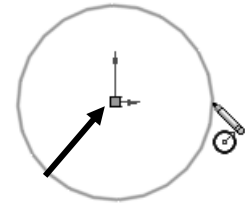
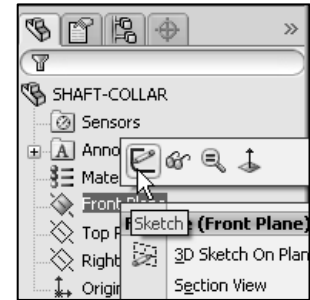

Fit the model to the Graphics window.

91) Press the **f** key.

92) Click **Isometric view**  from the Heads-Up View toolbar.

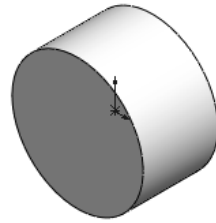

Save the model.

93) Click **Save** .

Activity: SHAFT-COLLAR Part-Extruded Cut Feature

Insert a new sketch for the Extruded Cut feature.

94) Right-click the **front circular face** of the Extrude1 feature for the Sketch plane. The mouse pointer displays the face feedback  icon.

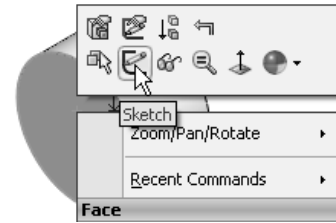

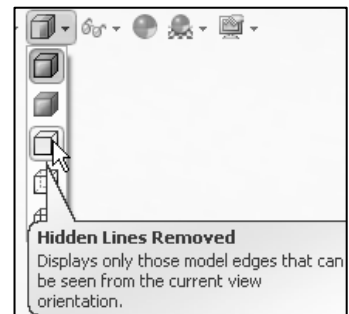

 View the mouse pointer feedback icon for the correct geometry: line, face, point, or vertex.

95) Click **Sketch**  from the Context toolbar as illustrated. The Sketch toolbar is displayed.



96) Click **Hidden Lines Removed**  from the Heads-up View toolbar.

97) Click the **Circle**  tool from the Sketch toolbar. The Circle PropertyManager is displayed. The cursor displays the Circle icon symbol .

98) Click the red **Origin** . The cursor displays the Coincident to point feedback symbol. Drag the **mouse pointer** to the right of the Origin.

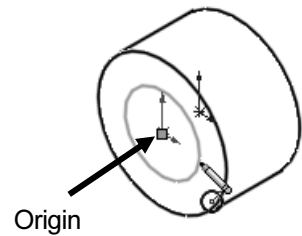

99) Click a **position** to create the circle as illustrated.

Add a dimension.

100) Click the **Smart Dimension**  Sketch tool.

101) Click the **circumference** of the circle.

102) Click a **position** diagonally above the circle in the Graphics window.

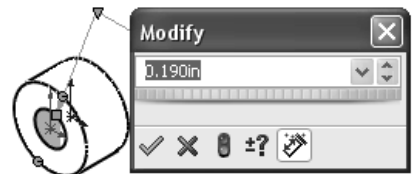

103) Enter **.190in, [4.83]** in the Modify dialog box.

104) Click the **Green Check mark**  in the Modify dialog box.

Insert an Extruded Cut feature.

105) Click the **Features** tab from the CommandManager.

106) Click **Extruded Cut**  from the Features toolbar. The Extrude PropertyManager is displayed.

107) Select **Through All** for End Condition in Direction 1. The direction arrow points to the right. Accept the default conditions.

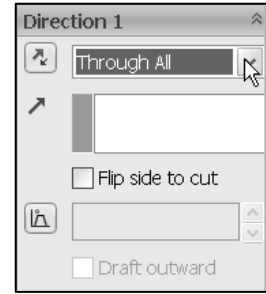

108) Click **OK**  from the Extrude PropertyManager. Extrude2 is displayed in the FeatureManager.



 The Extruded Cut feature is named Extrude2. The Through All End Condition removes material from the Front Plane through the Extrude1 geometry.

Activity: SHAFT-COLLAR-Modify Dimensions and Edit Color

Modify the dimensions.

109) Click **Trimetric view**  from the Heads-up View toolbar.

110) Click the **z** key a few times to Zoom in.

111) Click the **outside cylindrical face** of the SHAFT-COLLAR. The Extrude1 dimensions are displayed. Sketch dimensions are displayed in black. The Extrude depth dimensions are displayed in blue.

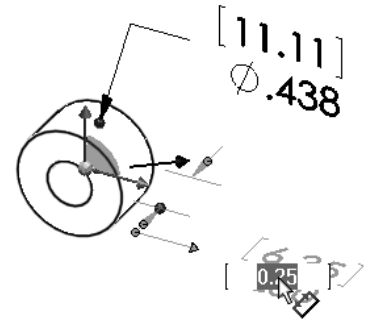

112) Click the **.250in, [6.35]** depth dimension.

113) Enter **.500in, [12.70]**.

The Extrude1 and Extrude2 are modified.

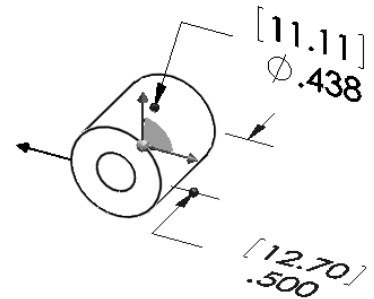

Return to the original dimensions.

114) Click the **Undo**  tool from the Menu bar.

115) Click **Shaded With Edges**  from the Heads-up View toolbar.

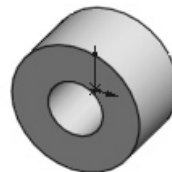

Modify the part color.

116) Right-click the **SHAFT-COLLAR Part**  icon at the top of the FeatureManager.

117) Click the **Appearances** drop-down arrow.

118) Click the **Appearance** box as illustrated. The Appearances PropertyManager is displayed. AXLE is displayed in the Selection box.

119) Select a **light green** color from the Color box.

120) Click **OK**  from the Appearances PropertyManager. View the SHAFT-COLLAR in the Graphics window.

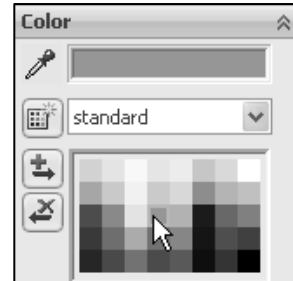
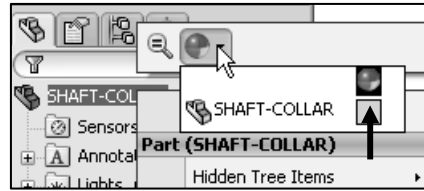

Save the SHAFT-COLLAR part.

121) Click **Save** . The SHAFT-COLLAR part is complete.

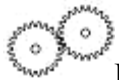



Review the SHAFT-COLLAR Part

The SHAFT-COLLAR utilized an Extruded Base  feature. The Extruded Base feature adds material. An Extruded feature required a Sketch plane, sketch, and depth.

The Sketch plane was the Front Plane. The 2D circle was sketched centered at the Origin. A dimension defined the overall size of the sketch.

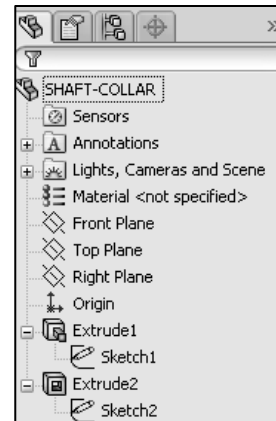
The name of the feature was Extrude1. Extrude1 utilized the Mid Plane End Condition. The Extrude1 feature was symmetric about the Front Plane.





The Extruded Cut  feature removed material to create the hole. The Extruded Cut feature default named is Extrude2. The Through All End Condition option created the Extrude2 feature. Feature dimensions were modified. The Edit Color option was utilized to modify the part color.

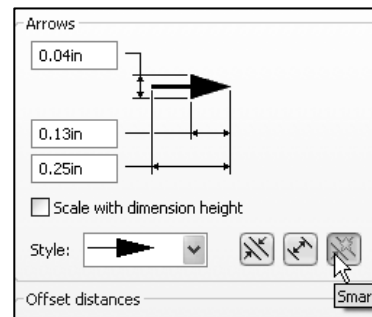

Click **Options, Document Properties** tab, **Dimension** and click the **Smart** box to have the dimension leader arrow head point inwards for ANSI.



 The SolidWorks Help contains step-by-step instructions for various commands. The Help  icon is displayed in the dialog box or in the PropertyManager for each feature.

Display Help for a rectangle.

122) Click **Help** from the Menu bar.

123) Click **SolidWorks Help**.

124) Click the **Index** tab.

125) Enter **rectangles**. The description is displayed in the right window.

126) Close  the Help window.

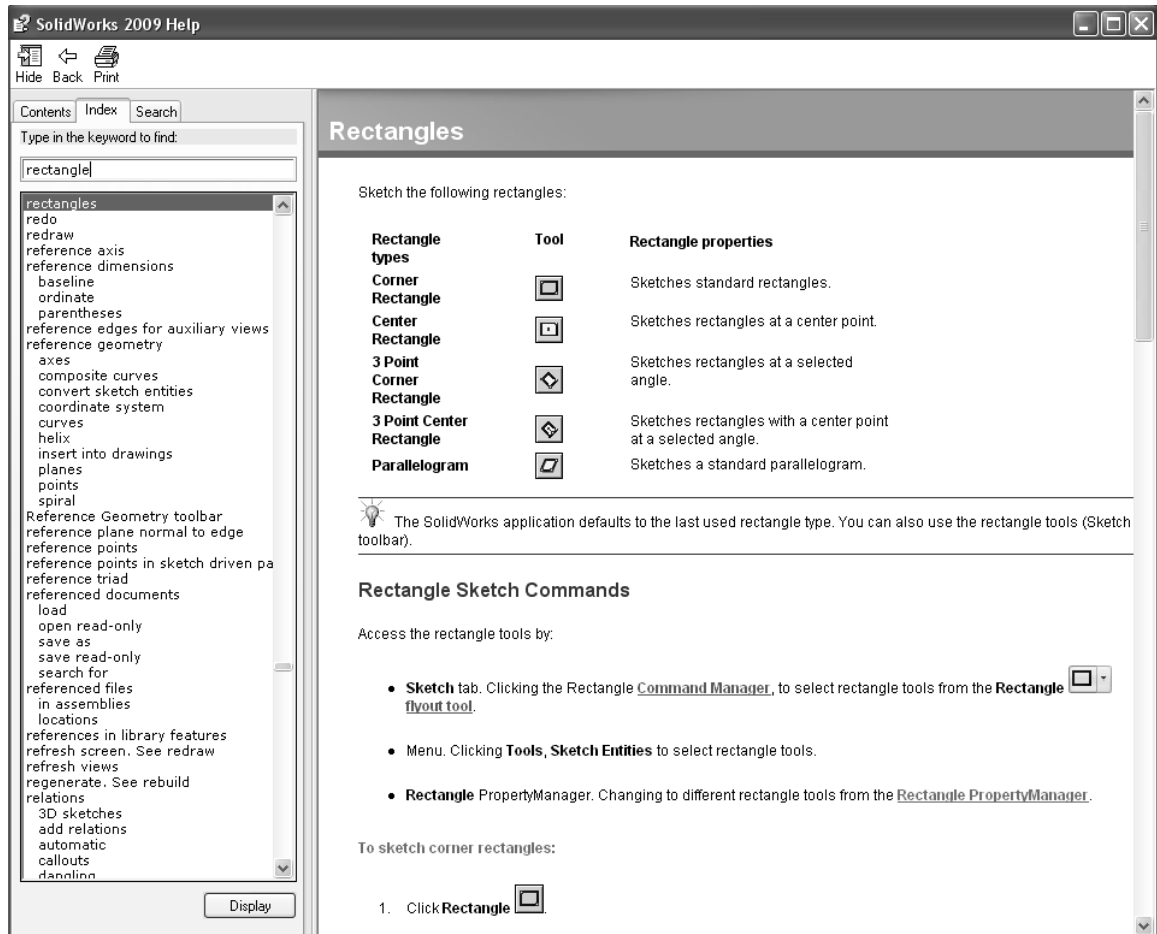
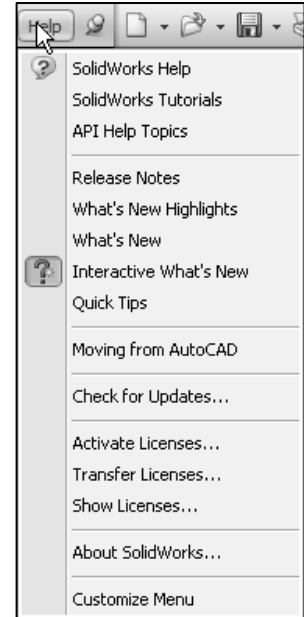

The Help option contains tools to assist the user. SolidWorks Help contains the following tabs:

- **Contents:** Contains the SolidWorks Online User's Guide documents.
- **Index:** Contains additional information on key words.
- **Search:** To locate information.

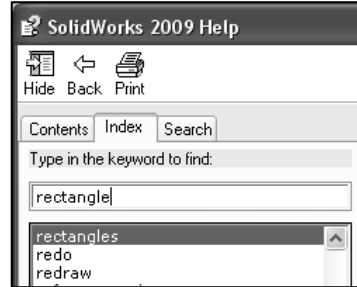

Display the SolidWorks Tutorials.

127) Click **Help** from the Menu bar.

128) Click **SolidWorks Tutorials**. The SolidWorks Tutorials categories are displayed.

129) Click the **Getting Started** category. Review Lesson 1. This is a great location for additional information.

130) Close  the SolidWorks Tutorial dialog box. Return to the Graphics window.

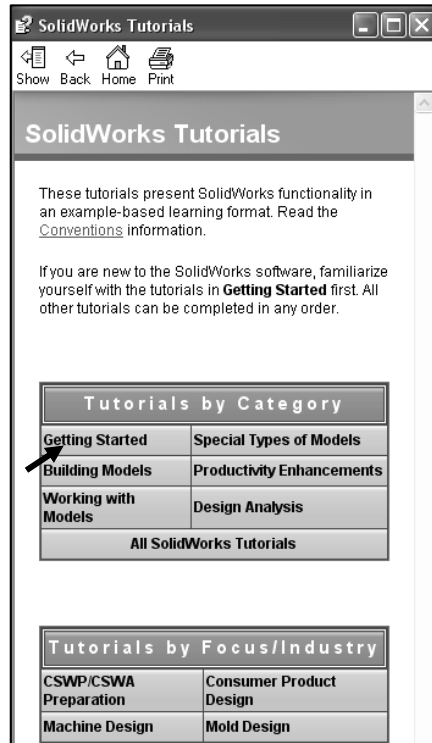

FLATBAR Part

The FLATBAR part fastens to the AXLE. The FLATBAR contains nine, $\varnothing.190$ in holes spaced 0.5in apart.

The FLATBAR part is manufactured from .090inch 6061 alloy.

Create the FLATBAR part. Utilize the new Straight Slot Sketch tool with an Extruded Base feature.

The Extruded feature requires a 2D profile sketched on the Front Plane.

The Straight Slot Sketch tool automatically applies design symmetry, (Midpoint and Equal geometric relations). Create the 2D profile centered about the Origin.

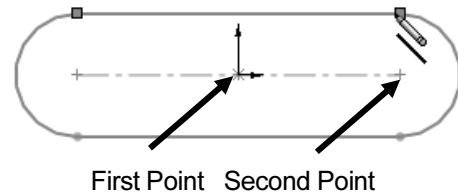
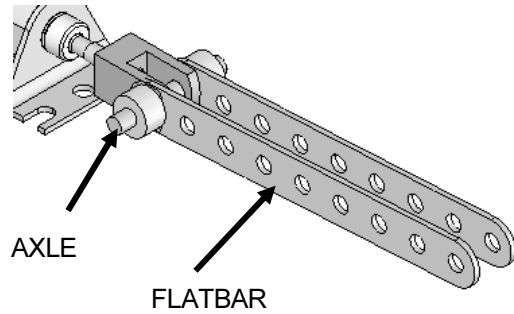

Relations control the size and position of entities with constraints.

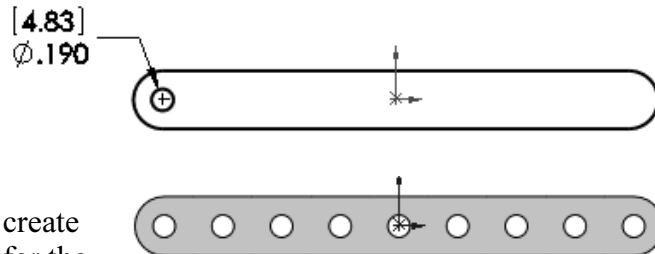

Utilize an Extruded Cut feature to create the first hole. This is the seed feature for the Linear Pattern.

Utilize a Linear Pattern feature to create the remaining holes. A Linear Pattern creates an array of features in a specified direction.

Activity: FLATBAR Part-Extruded Base Feature

Create a new part.

131) Click **New** from the Menu bar. The New SolidWorks Document dialog box is displayed. The Templates tab is the default tab. Part is the default template from the New SolidWorks Document dialog box.

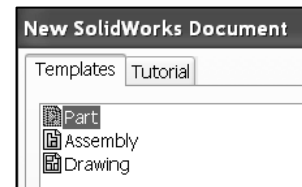

132) Double-click **Part**. The Part FeatureManager is displayed.

Save the part.

133) Click **Save As** from the Menu bar.

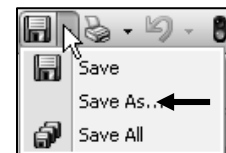

134) Enter **FLATBAR** for File name in the SW-TUTORIAL-2009 folder

135) Enter **FLAT BAR 9 HOLES** for Description.

136) Click **Save**. The FLATBAR FeatureManager is displayed.

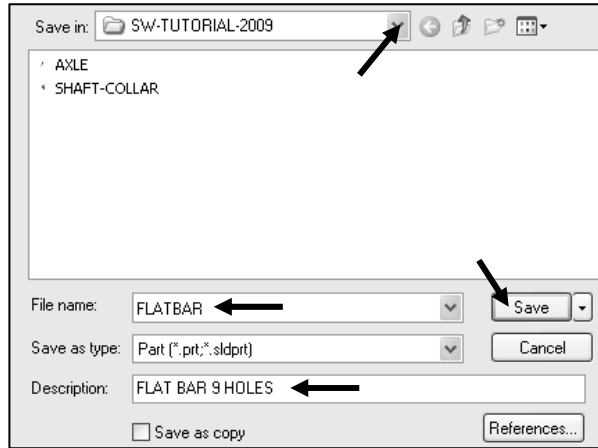

Set the Dimension standard and part units.

137) Click **Options**, **Document Properties** tab from the Menu bar.

138) Select **ANSI** from the Overall drafting standard drop-down menu.

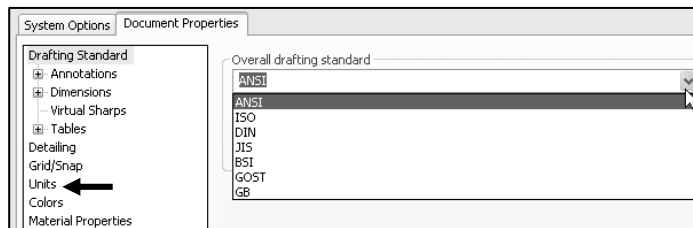

139) Click **Units**.

140) Click **IPS**, **[MMGS]** for Unit system.

141) Select **.123**, **[.12]** for Length units Decimal places.

142) Select **None** for Angular units Decimal places.

143) Click **OK** to set the document units.

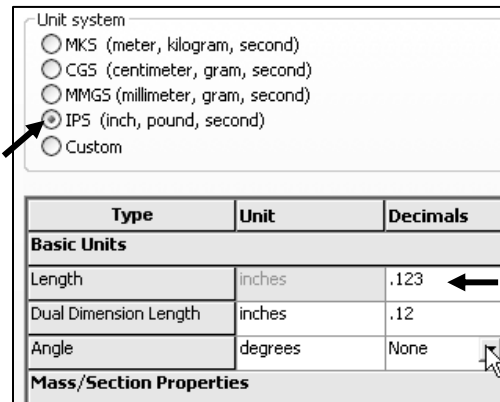

Insert a new sketch for the Extruded Base feature.

144) Right-click **Front Plane** from the FeatureManager. This is the Sketch plane.

145) Click **Sketch** from the Context toolbar as illustrated. The Sketch toolbar is displayed.

Utilize the new Consolidated Slot Sketch toolbar. Apply the Centerpoint Straight Slot Sketch tool. The Straight Slot Sketch tool provides the ability to sketch a straight slot from a centerpoint. In this example, use the Origin as your centerpoint.

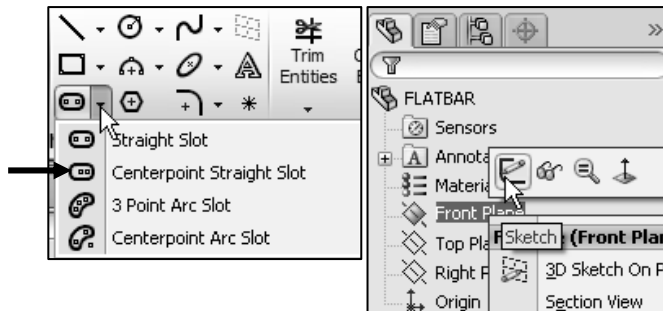

146) Click the **Centerpoint Straight Slot** tool from the Sketch toolbar. The Slot PropertyManager is displayed.

Create the Straight Slot with three points.

147) Click the **Origin**. This is your first point.

148) Click a **point** directly to the right of the Origin. This is your second point.

149) Click a **point** directly above the second point. This is your third point. The Straight Slot is displayed.

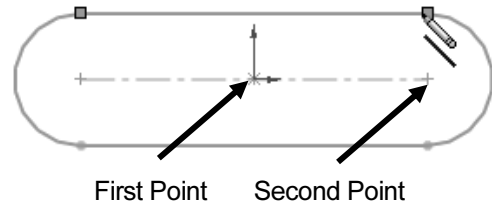

150) Click **OK** ✓ from the Slot PropertyManager

View the Sketch relations.

151) Click **View, Sketch Relations** from the Menu bar menu. View the sketch relations in the Graphics window.

Deactivate the Sketch relations.

152) Click **View**, uncheck **Sketch Relations** from the Menu bar. The Straight Slot Sketch tool provides a midpoint relation with the Origin and Equal relations between the other sketch entities.

Add a dimension.

153) Click the **Smart Dimension** tool from the Sketch toolbar.

154) Click the **horizontal centerline**.

155) Click a **position** above the top horizontal line in the Graphics window.

156) Enter **4.000in**, **[101.60]** in the Modify dialog box.

157) Click the **Green Check mark** ✓ in the Modify dialog box.

158) Click the **right arc** of the FLATBAR.

159) Click a **position** diagonally to the right in the Graphics window.

160) Enter **.250in**, **[6.35]** in the Modify dialog box.

161) Click the **Green Check mark** ✓ in the Modify dialog box. The black sketch is fully defined.

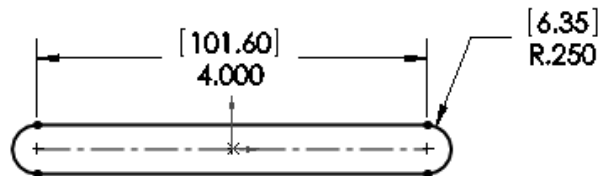
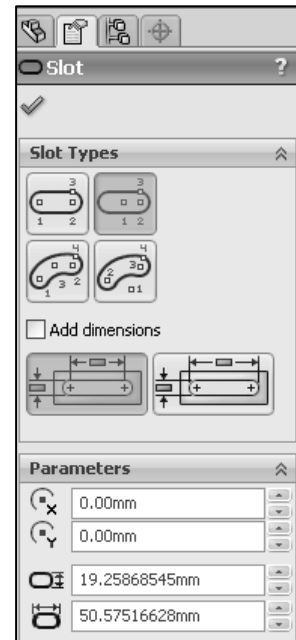

Extrude the sketch to create the Base feature.

162) Click **Extruded Boss/Base**  from the Features toolbar. The Extrude PropertyManager is displayed.

163) Enter **.090in, [2.29]** for Depth. Accept the default conditions.

164) Click **OK**  from the Extrude PropertyManager. Extrude1 is displayed in the FeatureManager.

Fit the model to the Graphics window.

165) Press the **f** key.

Save the FLATBAR part.

166) Click **Save** .

 Click **View, Origins** from the Menu bar menu to display the Origin in the Graphics window.

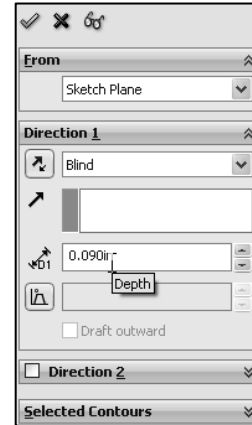
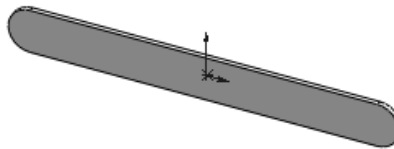

Activity: FLATBAR Part-Extruded Cut Feature

Insert a new sketch for the Extruded Cut Feature.

167) Right-click the **front face** of the Extrude1 feature in the Graphics window. This is the Sketch plane. Extrude1 is highlighted in the FeatureManager.

168) Click **Sketch**  from the Context toolbar as illustrated. The Sketch toolbar is displayed.

Display the Front view.

169) Click **Front view**  from the Heads-up View toolbar.

170) Click **Hidden Lines Removed**  from the Heads-up View toolbar.

The process of placing the mouse pointer over an existing arc to locate its centerpoint is called “wake up”.

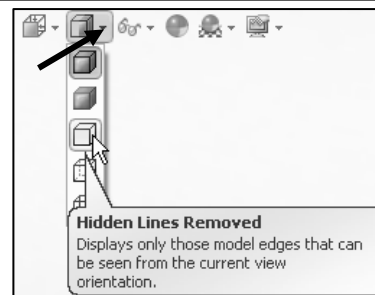
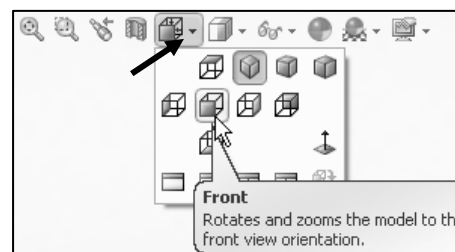
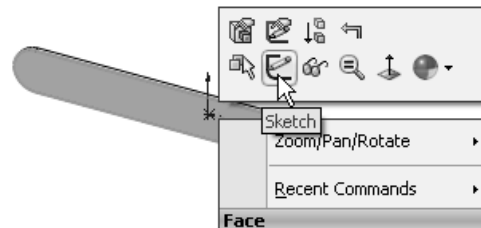

Wake up the center point.

- 171)** Click the **Circle**  Sketch tool from the Sketch toolbar.
The Circle PropertyManager is displayed.

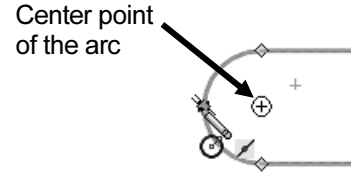

- 172)** Place the **mouse pointer** on the left arc. Do not click. The center point of the slot arc is displayed.

- 173)** Click the **centerpoint** of the arc.

- 174)** Click a **position** to the right of the center point to create the circle as illustrated.

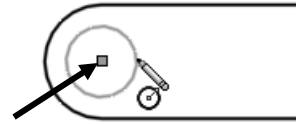

Add a dimension.

- 175)** Click the **Smart Dimension**  Sketch tool.

- 176)** Click the **circumference** of the circle.

- 177)** Click a **position** diagonally above and to the left of the circle in the Graphics window.

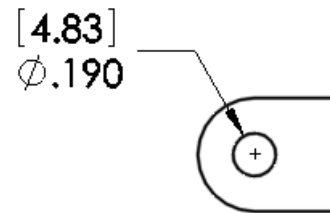

- 178)** Enter **.190in, [4.83]** in the Modify box.

- 179)** Click the **Green Check mark**  in the Modify dialog box.

- 180)** Click **Isometric view**  from the Heads-up View toolbar.

- 181)** Click **Shaded With Edges**  from the Heads-up View toolbar.

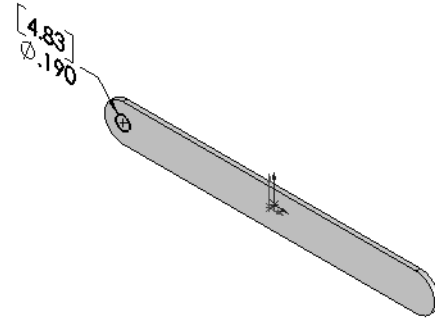



Insert an Extruded Cut feature.

- 182)** Click the **Features** tab from the CommandManager.

- 183)** Click **Extruded Cut**  from the Features toolbar.
The Extrude PropertyManager is displayed.

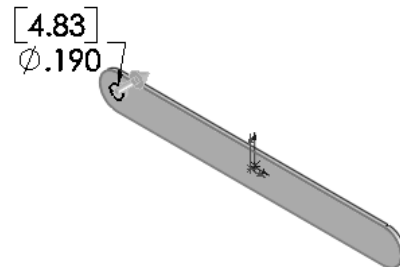
- 184)** Select **Through All** for End Condition in Direction 1.
The direction arrow points to the back. Accept the default conditions.



- 185)** Click **OK**  from the Extrude PropertyManager.
The Extrude2 feature is displayed in the FeatureManager.

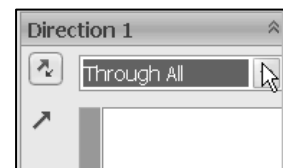

Save the FLATBAR part.

- 186)** Click **Save** .

The blue Extrude2 icon indicates that the feature is selected.

Select features by clicking their icons in the FeatureManager or by selecting their geometry in the Graphics window.

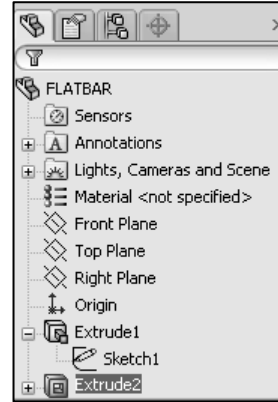

Activity: FLATBAR Part-Linear Pattern Feature

Create a Linear Pattern feature.

187) Click the **Linear Pattern**  tool from the Features toolbar. The Linear Pattern PropertyManager is displayed. Extrude2 is displayed in the Features to Pattern box. Note: If Extrude2 is not displayed, click inside the Features to Pattern box. Click Extrude2 from the fly-out FeatureManager.

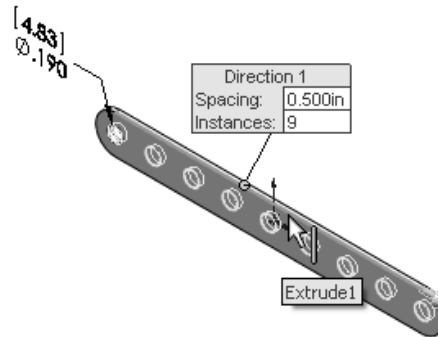

188) Click the **top edge** of the Extrude1 feature for Direction1 in the Graphics window. Edge<1> is displayed in the Pattern Direction box.

189) Enter **0.5in**, [**12.70**] for Spacing.

190) Enter **9** for Number of Instances. Instances are the number of occurrences of a feature.

191) The Direction arrow points to the right.

Click the **Reverse Direction**  button if required.

192) Geometry Pattern is check by default. Click **OK**  from the Linear Pattern PropertyManager. The LPattern1 feature is displayed in the FeatureManager.

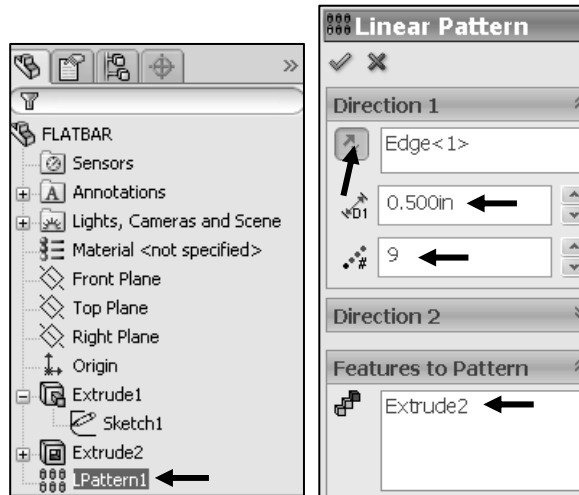

Save the FLATBAR part.

193) Click **Save** . The FLATBAR part is complete.

Close all documents.

194) Click **Windows, Close All** from the Menu bar.

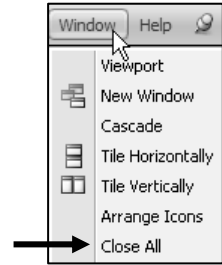



Review the FLATBAR Part

The FLATBAR part utilized an Extruded Base  feature as the first feature. The Sketch plane was the Front Plane. The 2D sketch utilized the Straight Slot Sketch tool to create the slot profile.

You added linear and radial dimensions to define your sketch. You applied the Extruded Base feature with a Blind End Condition in Direction 1. Extrude1 is created.

You created a circle sketch for the Extruded Cut feature on the front face of Extrude1.

The front face was your Sketch plane for the Extruded Cut feature. The Extruded Cut  feature removed material to create the hole. The Extruded Cut feature default name is Extrude2. The Through All End Condition option in Direction 1 created the Extrude2 feature. The Extrude2 feature is the seed feature for the Linear Pattern of holes.

The Linear Pattern  feature created an array of 9 holes, equally spaced along the length of the FLATBAR part.

LINKAGE Assembly

An assembly is a document that contains two or more parts. An assembly inserted into another assembly is called a sub-assembly. A part or sub-assembly inserted into an assembly is called a component. The LINKAGE assembly consists of the following components: AXLE, SHAFT-COLLAR, FLATBAR, and AirCylinder sub-assembly.

Establishing the correct component relationship in an assembly requires forethought on component interaction. Mates are geometric relationships that align and fit components in an assembly. Mates remove degrees of freedom from a component.

Mate Types

Mates reflect the physical behavior of a component in an assembly. The components in the LINKAGE assembly utilize Standard mate types. Review the Standard, Advanced, and Mechanical mate types.

Standard Mates:

Components are assembled with various mate types. The Standard mate types are:

Coincident Mate: Locates the selected faces, edges, or planes so they use the same infinite line. A Coincident mate positions two vertices for contact

Parallel Mate: Locates the selected items to lie in the same direction and to remain a constant distance apart.

Perpendicular Mate: Locates the selected items at a 90 degree angle to each other.

Tangent Mate: Locates the selected items in a tangential mate. At least one selected item must be either a conical, cylindrical, spherical face.

Concentric Mate: Locates the selected items so they can share the same center point.

Lock Mate: Maintains the position and orientation between two components.

Distance Mate: Locates the selected items with a specified distance between them. Use the drop-down arrow box or enter the distance value directly.

Angle Mate: Locates the selected items at the specified angle to each other. Use the drop-down arrow box or enter the angle value directly.

There are two Mate Alignment options. The Aligned option positions the components so that the normal vectors from the selected faces point in the same direction. The Anti-Aligned option positions the components so that the normal vectors from the selected faces point in opposite directions.

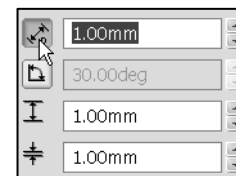
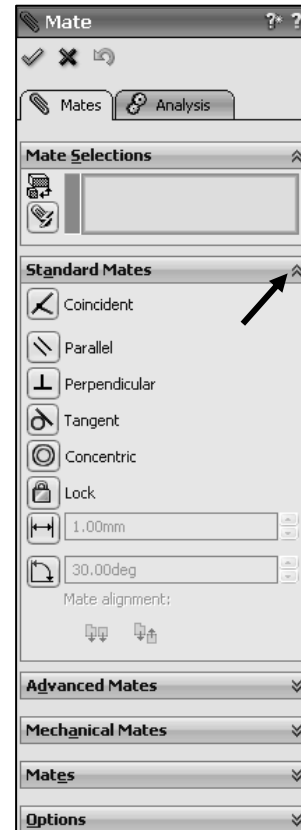



Mates reflect the physical behavior of a component in an assembly. In this project, the two most common mate types are Concentric and Coincident.

Advanced Mates:

The Advanced mate types are:

Symmetric Mate: Positions two selected entities to be symmetric about a plane or planar face. A Symmetric Mate does not create a Mirrored Component.

Width Mate: Centers a tab within the width of a groove.

Path Mate: Constrains a selected point on a component to a path.

Linear/Linear Coupler Mate: Establishes a relationship between the translation of one component and the translation of another component.

Distance Mate: Locates the selected items with a specified distance between them. Use the drop-down arrow box or enter the distance value directly.

Angle Mate: Locates the selected items at the specified angle to each other. Use the drop-down arrow box or enter the angle value directly.

Mechanical Mates:

The Mechanical mate types are:

Cam Mate: Forces a plane, cylinder, or point to be tangent or coincident to a series of tangent extruded faces.

Hinge Mate: Limits the movement between two components to one rotational degree of freedom.

Gear Mate: Forces two components to rotate relative to one another around selected axes.

Rack Pinion Mate: Provides the ability to have Linear translation of a part, rack causes circular rotation in another part, pinion, and vice versa.

Screw Mate: Constrains two components to be concentric, and also adds a pitch relationship between the rotation of one component and the translation of the other.

Universal Joint Mate: The rotation of one component (the output shaft) about its axis is driven by the rotation of another component (the input shaft) about its axis.

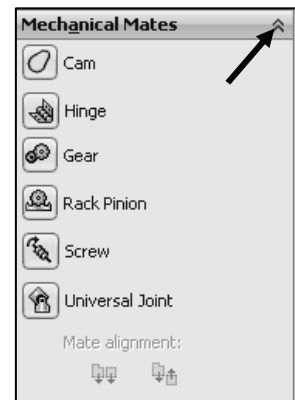
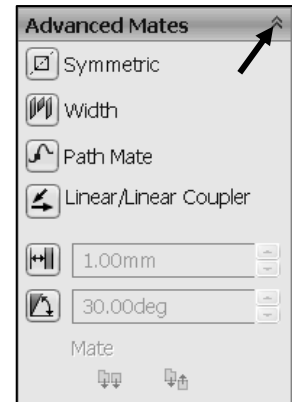

Example: Utilize a Concentric mate between the AXLE cylindrical face and the FLATBAR Extruded Cut feature, (hole). Utilize a Coincident mate between the SHAFT-COLLAR back face and the FLATBAR front flat face.

The LINKAGE assembly requires the AirCylinder assembly. The AirCylinder assembly is located on the SolidWorks Tutorial Multimedia CD in the Pneumatic Components folder.

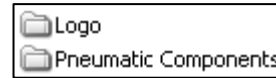

Activity: AirCylinder Assembly-Open and Save As option

Copy the folders and files from the CD in the book.

195) Minimize the SolidWorks Graphics window.

196) Insert the CD from the book into your computer. If required, **exit** out of AutoPlay for the Multi-media movies.

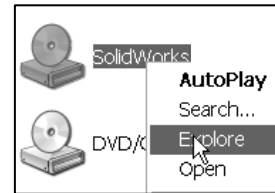

197) Right-click your CD drive icon.

198) Click Explore. View the available folders.

199) Copy the folders and files from the CD to your SW-TUTORIAL-2009 folder on the hard drive.

Return to SolidWorks. Create a new assembly.

200) Maximize the SolidWorks Graphics window.

201) Click New from the Menu bar. The New SolidWorks Document dialog box is displayed. The Templates tab is the default tab.

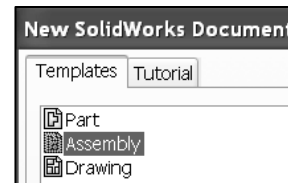

202) Double-click Assembly from the New SolidWorks Document dialog box. The Begin Assembly PropertyManager is displayed.

203) Click the Browse button.

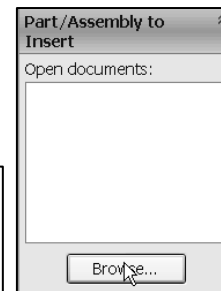

204) Double-click the AirCylinder assembly from the SW-TUTORIAL-2009/Pneumatic Components folder. The AirCylinder assembly is displayed in the Graphics window.



If an assembly or component is loaded in a Lightweight state, right-click the **assembly name** or **component name** from the FeatureManager. Click **Set Lightweight to Resolved**.

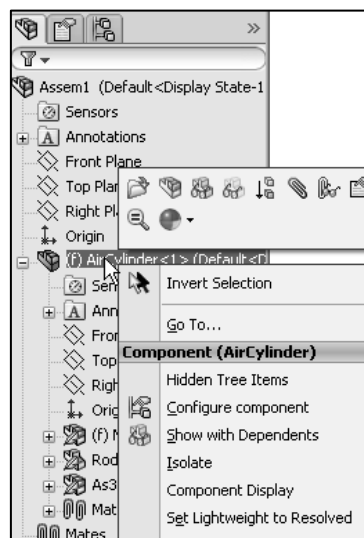

205) Click **OK**  from the Begin Assembly PropertyManager to fix the AirCylinder assembly in the Graphics window. The (f) symbol is placed in front of the AirCylinder name in the FeatureManager.

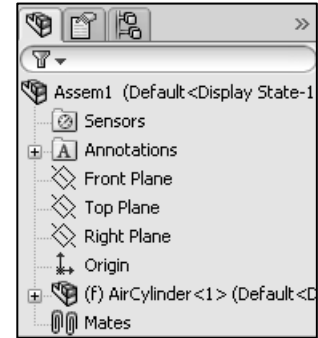

206) If required, click **Yes** to Rebuild.

207) Click **Save As** from the Menu bar.

208) Select **SW-TUTORIAL-2009** for Save in folder.

209) Enter **LINKAGE** for file name.

210) Click the **References** button.

211) Click the **Browse** button from the Specify folder for selected items.

212) Select the **SW-TUTORIAL-2009** folder.

213) Click **OK** from the Browse For Folder dialog box.

214) Click **Save All**. The LINKAGE assembly FeatureManager is displayed.

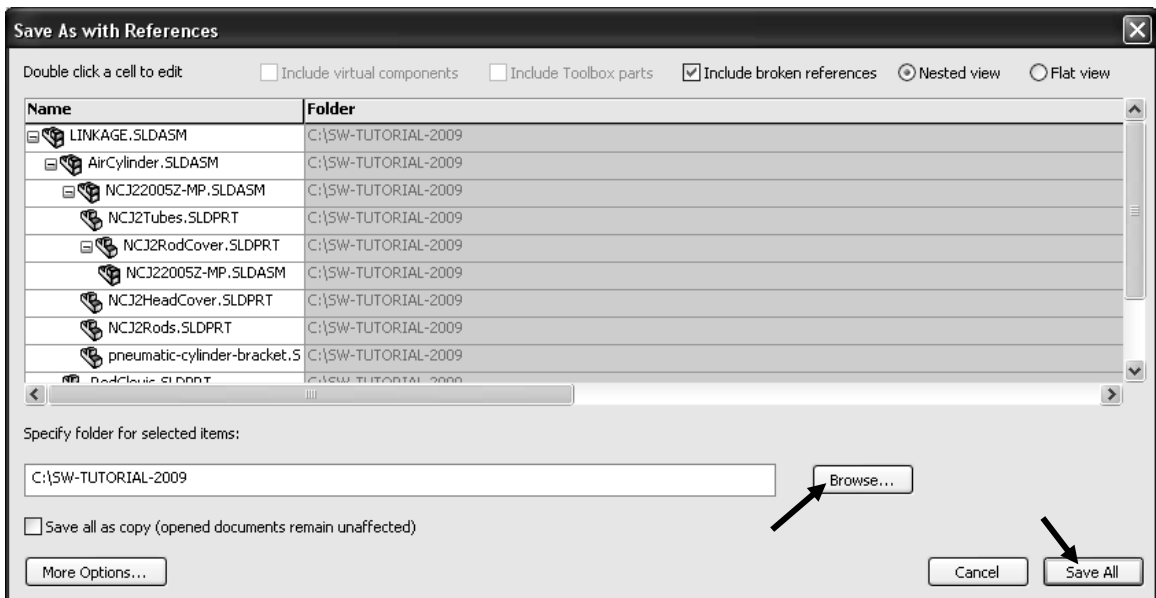
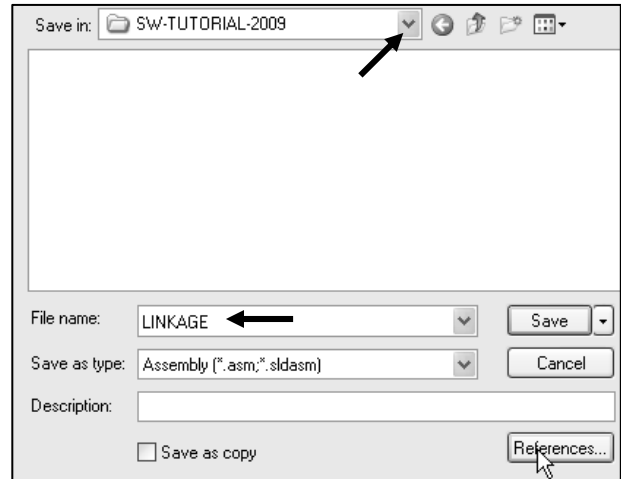

The AirCylinder assembly and its references are copied to the SW-TUTORIAL-2009 folder.

Assemble the AXLE to the holes in the RodClevis.

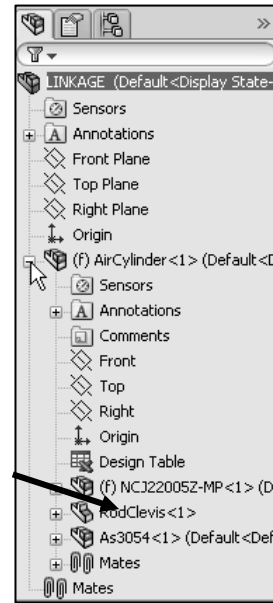
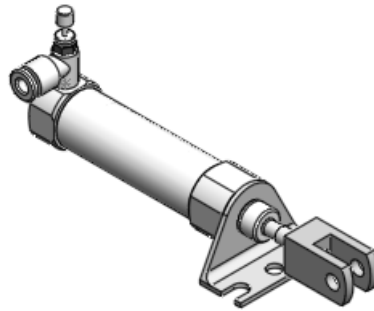

Display the RodClevis component in the FeatureManager.

215) Expand the AirCylinder assembly in the FeatureManager.

216) Click **RodClevis<1>** from the FeatureManager. Note: The RodClevis is displayed in blue in the Graphics window.

If required hide the Origins.

217) Click **View**, uncheck **Origins** from the Menu bar.

The AirCylinder is the first component in the LINKAGE assembly and is fixed (f) to the LINKAGE assembly Origin.

Display an Isometric view.

218) Click **Isometric view**  from the Heads-up View toolbar.

Insert the AXLE part.

219) Click the **Assembly** tab in the CommandManager.

220) Click the **Insert Components**  Assembly tool. The Insert Component PropertyManager is displayed.

221) Click the **Browse** button.

222) Select **All Files** from the Files of type box.

223) Double-click **AXLE** from the SW-TUTORIAL-2009 folder.

224) Click a **position** to the front of the AirCylinder assembly as illustrated.

Move the AXLE component.

225) Click and drag a **position** in front of the RODCLEVIS.

Enlarge the view.

226) **Zoom in** on the RodClevis and the AXLE.

Insert a Concentric mate.

227) Click the **Mate**  tool from the Assembly toolbar. The Mate PropertyManager is displayed.

228) Click the inside **front hole face** of the RodClevis. The cursor displays the face feedback symbol.

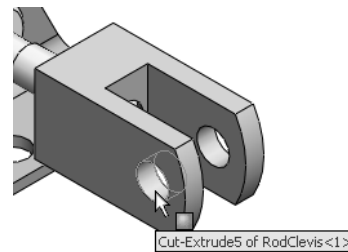
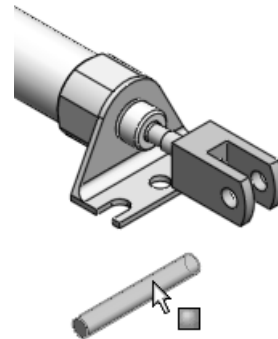
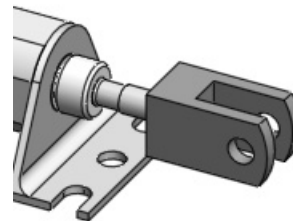

229) Click the **long cylindrical face** of the AXLE. The cursor displays the face feedback symbol. The selected faces are displayed in the Mate Selections box. Concentric mate is selected by default. The AXLE is positioned concentric to the RodClevish hole.

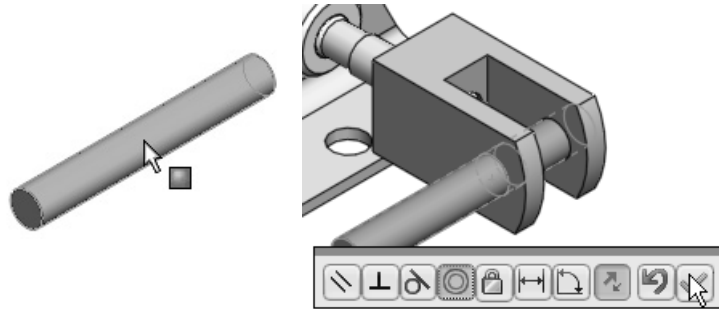

230) Click the **Green Check mark** ✓ as illustrated.

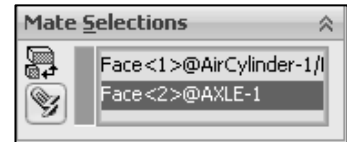

Move the AXLE.

231) Click and drag the **AXLE** left to right. The AXLE translates in and out of the RodClevish holes.

The Mate Pop-up toolbar is displayed after selecting the two cylindrical faces. The Mate Pop-up toolbar minimizes the time required to create a mate.

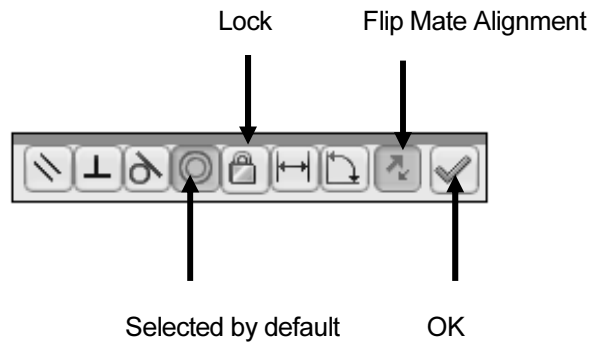

 Position the mouse pointer in the middle of the face to select the entire face. Do not position the mouse pointer near the edge of the face. If the wrong face or edge is selected, perform one of the following actions:

- Click the face or edge again to remove it from the Mate Selections box.
- Right-click in the Graphics window. Click Clear Selections to remove all geometry from the Items Selected text box.
- Right-click in the Mate Selections box to either select Clear Selections or to delete a single selection.
- Utilize the Undo button to begin the Mate command again.

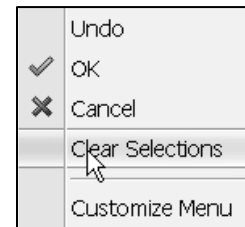

Display the Top view.

232) Click **Top view**  from the Heads-up View toolbar.

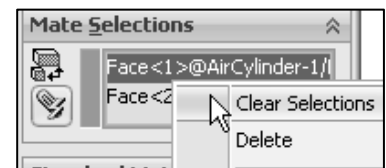

Expand the LINKAGE assembly and components in the fly-out FeatureManager.

233) **Expand** the LINKAGE assembly from the fly-out FeatureManager.

234) Expand the AirCylinder assembly from the fly-out FeatureManager.

235) Expand the AXLE part from the fly-out FeatureManager.

236) Expand the Features folder.

Clear all sections from the Mate Selections box.

237) Right-click **Clear Selections** inside the Mate Selections box.

Insert a Coincident mate.

238) Click the **Front Plane** of the AirCylinder assembly from the fly-out FeatureManager.

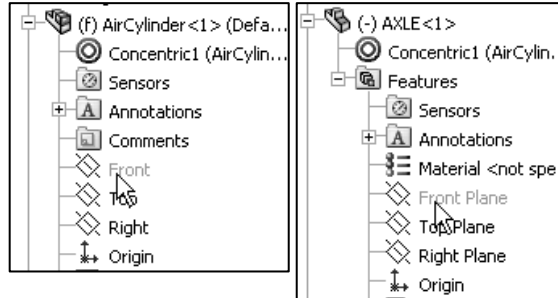

239) Click the **Front Plane** of the AXLE part from the fly-out FeatureManager. The selected planes are displayed in the Mate Selections box. Coincident mate is selected by default.

240) Click the **Green Check mark** ✓.

241) Click **OK** ✓ from the Mate PropertyManager.

The AirCylinder Front Plane and the AXLE Front Plane are Coincident. The AXLE is centered in the RodClevis.

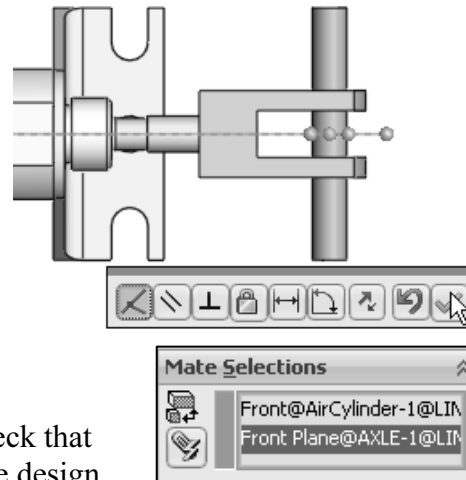

💡 Display the Mates in the FeatureManager to check that the components and the Mate types correspond to the design intent. Note: If you delete a Mate and then recreate it, the Mate numbers will be in a different order.

Display an Isometric view.

242) Click **Isometric view**  from the Heads-up View toolbar.

Display the Mates in the folder.

243) Expand the Mates folder in the FeatureManager. View the created mates.

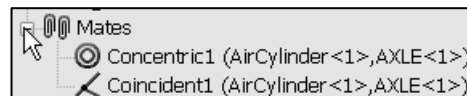

Save the LINKAGE assembly.

244) Click **Save** .

Activity: LINKAGE Assembly-Insert FLATBAR Part

Insert the FLATBAR part.

245) Click the **Insert Components**  Assembly tool. The Insert Component PropertyManager is displayed. Click the **Browse** button.

246) Select **Part** for Files of type from the SW-TUTORIAL-2009 folder.

247) Double-click **FLATBAR**.

Place the component in the assembly.

248) Click a **position** in the Graphics window as illustrated. Note: Use the z key to Zoom out if required.

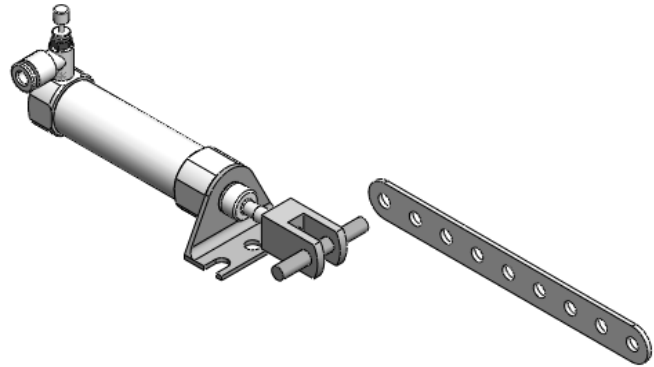

Enlarge the view.

249) **Zoom in** on the AXLE and the left side of the FLATBAR to enlarge the view.

Insert a Concentric mate.

250) Click the **Mate**  tool from the Assembly toolbar. The Mate PropertyManager is displayed. If required, right-click **Clear Selections** inside the Mate Selections box.

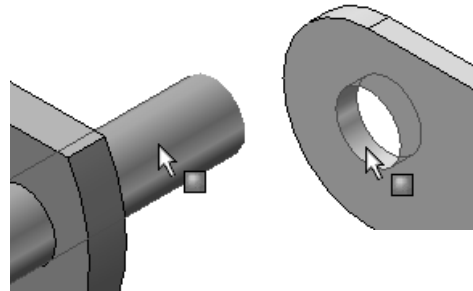

251) Click the inside **left hole face** of the FLATBAR.

252) Click the **long cylindrical face** of the AXLE. The selected faces are displayed in the Mate Selections box. Concentric is selected by default.



253) Click the **Green Check mark** .



Fit the model to the Graphics window.

254) Press the **f** key.

Move the FLATBAR.

255) Click and drag the **FLATBAR**. The FLATBAR translates and rotates along the AXLE.

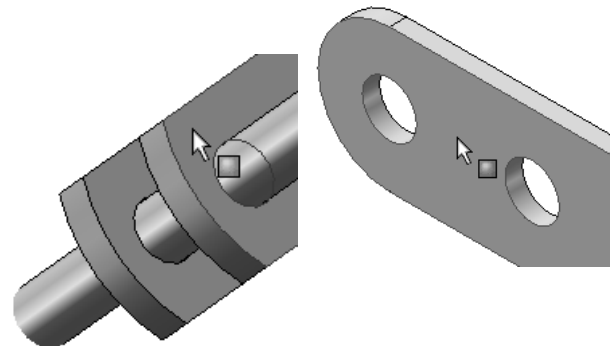

Insert a Coincident mate.

256) Click the **front face** of the FLATBAR.

257) Press the **left arrow key** approximately 5 times to rotate the model and to view the back face of the RodClevis.

258) Click the **back face** of the RodClevis as illustrated. The selected faces are displayed in the Mate Selections box. Coincident is selected by default.



259) Click the **Green Check mark** ✓ .

260) Click **OK** ✓ from the Mate PropertyManager.

Display the Isometric view.

261) Click **Isometric view**  from the Heads-up View toolbar.

Insert the second FLATBAR component.

262) Click the **Insert Components**  Assembly tool. The Insert Component PropertyManager is displayed.

263) Click the **Browse** button.

264) Select **Part** for Files of type from the SW-TUTORIAL-2009 folder.

265) Double-click **FLATBAR**.

266) Click a **position** to the front of the AirCylinder in the Graphics window as illustrated.

Enlarge the view.

267) **Zoom in** on the second FLATBAR and the AXLE.

Insert a Concentric mate.

268) Click the **Mate**  tool from the Assembly tool. The Mate PropertyManager is displayed.

269) Click the **left inside hole face** of the second FLATBAR.

270) Click the **long cylindrical face** of the AXLE. The selected faces are displayed in the Mate Selections box. Concentric is selected by default.

271) Click the **Green Check mark** ✓ .

272) Click and drag the **second FLATBAR** to the front.

Fit the model to the Graphics window.

273) Press the **f** key.

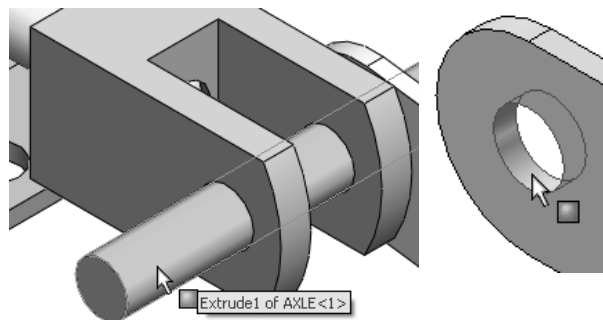
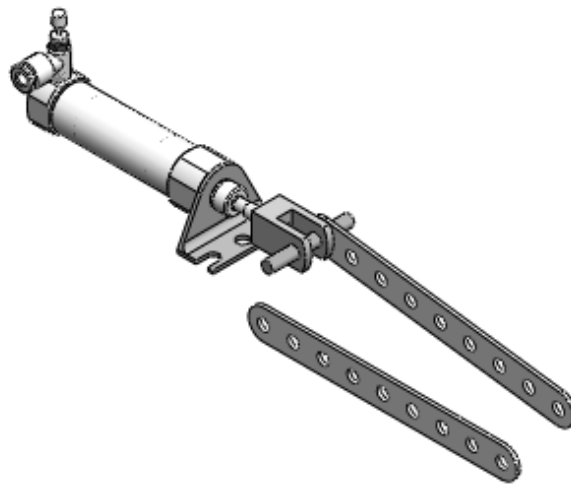
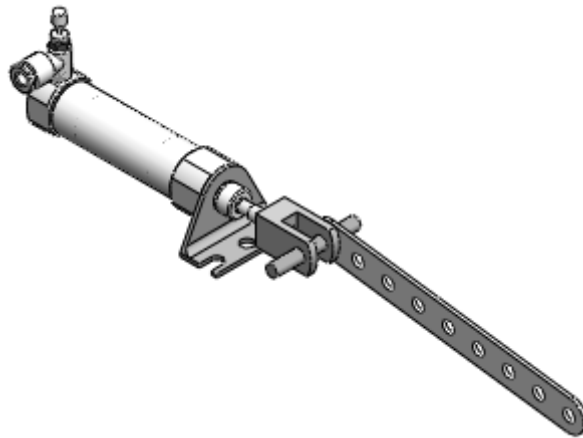

Insert a Coincident mate.

274) Press the **left arrow key** approximately 5 times to rotate the model to view the back face of the second FLATBAR.

275) Click the **back face** of the second FLATBAR.

276) Press the **right arrow key** approximately 5 times to rotate the model to view the front face of the RodClevis.

277) Click the **front face** of the RodClevis. The selected faces are displayed in the Mate Selections box. Coincident is selected by default.

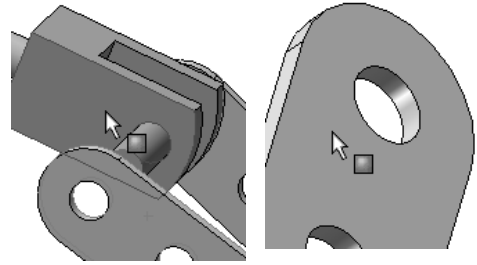

278) Click the **Green Check mark** ✓.



Insert a Parallel mate.

279) Press the **Shift-z** keys to Zoom in on the model.

280) Click the **top narrow face** of the first FLATBAR.

281) Click the **top narrow face** of the second FLATBAR. The selected faces are displayed in the Mate Selections box.

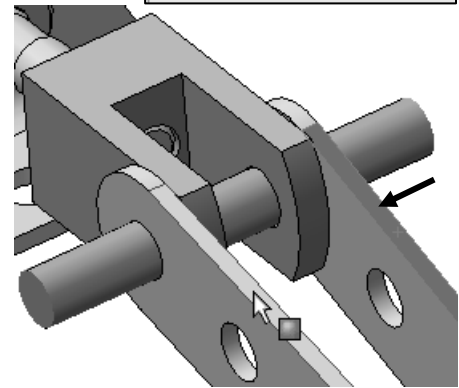

282) Click **Parallel** ∥.

283) Click the **Green Check mark** ✓.

284) Click **OK** ✓ from the Mate PropertyManager.



285) Click **Isometric view**  from the Heads-up View toolbar.



Move the two FLATBAR parts.

286) Click and drag the **second FLATBAR**. Both FLATBAR parts move together.

View the Mates folder.

287) **Expand** the Mates folder from the FeatureManager. View the created mates.

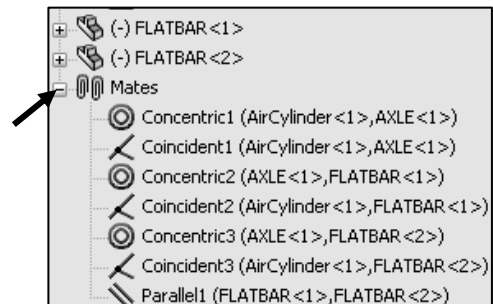

Activity: LINKAGE Assembly-Insert SHAFT-COLLAR Part

Insert the first SHAFT-COLLAR.

288) Click the **Insert Components**  Assembly tool. The Insert Component PropertyManager is displayed.

289) Click the **Browse** button.

290) Select **Part** for Files of type from the SW-TUTORIAL-2009 folder.

291) Double-click **SHAFT-COLLAR**.

292) Click a **position** to the back of the AXLE as illustrated.

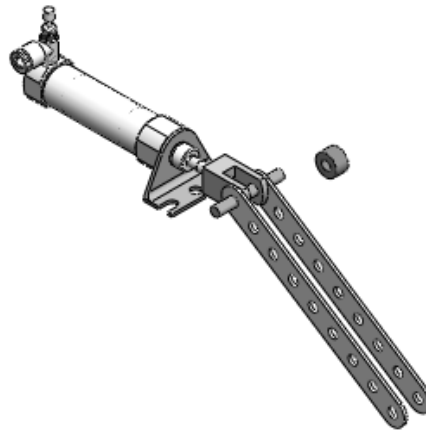

Enlarge the view.

293) Click the **Zoom to Area**  tool.

294) **Zoom-in** on the SHAFT-COLLAR and the AXLE component.

Deactivate the tool.

295) Click the **Zoom to Area**  tool.

Insert a Concentric mate.

296) Click the **Mate**  tool from the Assembly toolbar. The Mate PropertyManager is displayed.

297) Click the inside **hole face** of the SHAFT-COLLAR.

298) Click the **long cylindrical face** of the AXLE. The selected faces are displayed in the Mate Selections box. Concentric is selected by default.

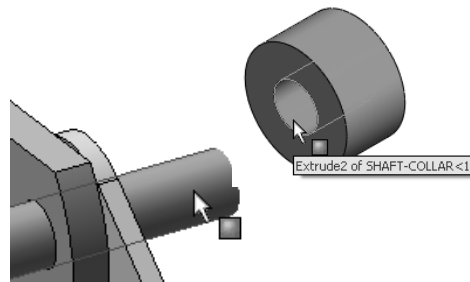

299) Click the **Green Check mark**  .

Insert a Coincident mate.

300) Press the **Shift-z** keys to Zoom in on the model.

301) Click the **front face** of the SHAFT-COLLAR as illustrated.

302) Press the **left arrow key** approximately 5 times to rotate the model to view the back face of the first FLATBAR.

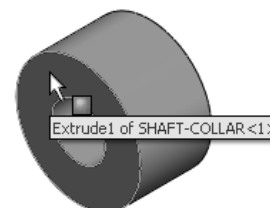
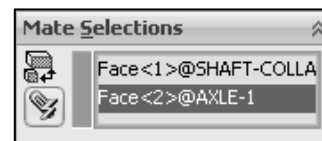

303) Click the **back face** of the first FLATBAR. The selected faces are displayed in the Mate Selections box. Coincident is selected by default.

304) Click the **Green Check mark** ✓.

305) Click **OK** ✓ from the Mate PropertyManager.

Display the Isometric view.

306) Click **Isometric view**  from the Heads-up View toolbar.

Insert the second SHAFT-COLLAR.

307) Click the **Insert Components**  Assembly tool. The Insert Component PropertyManager is displayed.

308) Click the **Browse** button.

309) Select **Part** for Files of type from the SW-TUTORIAL-2009 folder.

310) Double-click **SHAFT-COLLAR**.

311) Click a **position** near the AXLE as illustrated.

Enlarge the view.

312) Click the **Zoom to Area**  tool.

313) **Zoom-in** on the second SHAFT-COLLAR and the AXLE to enlarge the view.

314) Click the **Zoom to Area**  tool to deactivate the tool.

Insert a Concentric mate.

315) Click **Mate**  from the Assembly toolbar. The Mate PropertyManager is displayed.

316) Click the **inside hole face** of the second SHAFT-COLLAR.

317) Click the **long cylindrical face** of the AXLE. Concentric is selected by default. The selected faces are displayed in the Mate Selections box.

318) Click the **Green Check mark** ✓.

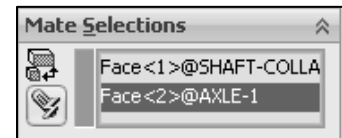
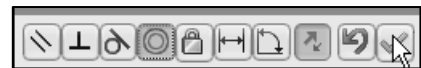
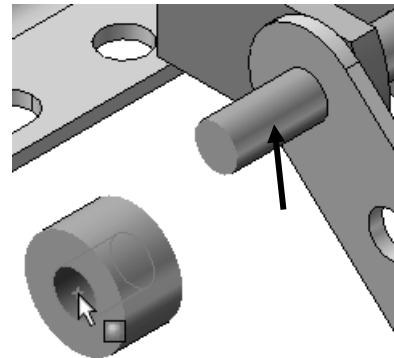
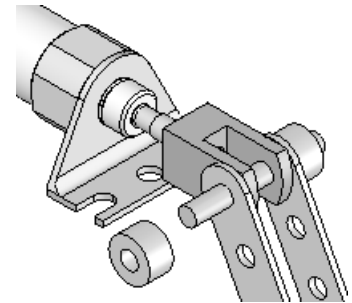
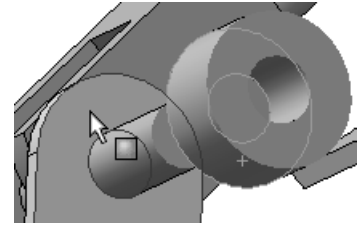

Insert a Coincident mate.

319) Click the **back face** of the second SHAFT-COLLAR.

320) Click the **front face** of the second FLATBAR. The selected faces are displayed in the Mate Selections box. Coincident is selected by default.

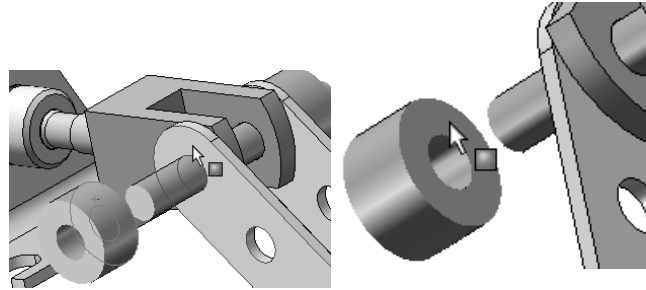

321) Click the **Green Check mark** ✓.



322) Click **OK** ✓ from the Mate PropertyManager.

323) **Expand** the Mates folder. View the created mates.



Display an Isometric view.

324) Click **Isometric view**  from the Heads-up View toolbar.

Fit the model to the Graphics window.

325) Press the **f** key.

Save the LINKAGE assembly.

326) Click **Save** . The LINKAGE assembly is complete.

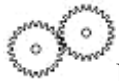
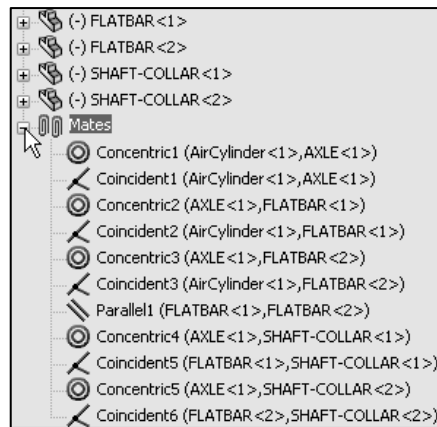

Review the LINKAGE Assembly

An assembly is a document that contains two or more parts. A part or sub-assembly inserted into an assembly is called a component. You created the LINKAGE assembly.

The AirCylinder sub-assembly was the first component inserted into the LINKAGE assembly. The AirCylinder assembly was obtained from the CD in the book and copied to the SW-TUTORIAL-2009 folder.

The AirCylinder assembly was fixed to the Origin. The Concentric and Coincident mates added Geometric relationships between the inserted components in the LINKAGE assembly.

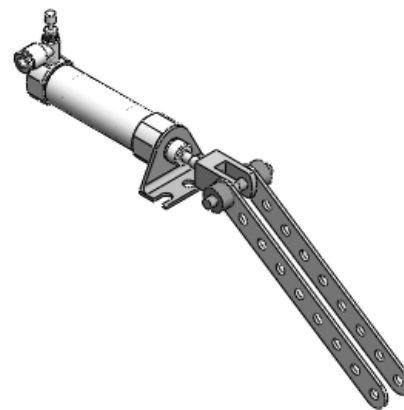

The AXLE part was the second component inserted into the LINKAGE assembly. The AXLE required a Concentric mate between the two cylindrical faces and a Coincident mate between two the Front Planes.

The FLATBAR part was the third component inserted into the LINKAGE assembly. The FLATBAR required a Concentric mate between the two cylindrical faces and a Coincident mate between the two flat faces.

A second FLATBAR was inserted into the LINKAGE assembly. A Parallel mate was added between the two FLATBARs.

Two SHAFT-COLLAR parts were inserted into the LINKAGE assembly. Each SHAFT-COLLAR required a Concentric mate between the two cylindrical faces and a Coincident mate between the two flat faces.

Motion Study – Basic Motion Tool

Motion Studies are graphical simulations of motion for assembly models. You can incorporate visual properties such as lighting and camera perspective into a motion study. Motion studies do not change an assembly model or its properties. They simulate and animate the motion you prescribe for your model. Use SolidWorks mates to restrict the motion of components in an assembly when you model motion.

Create a Motion Study. Select the Basic Motion option from the MotionManager. The Basic Motion option provides the ability to approximate the effects of motors, springs, collisions and gravity on your assembly. Basic Motion takes mass into account in calculating motion. Note: The Animation option does not!

Activity: LINKAGE Assembly-Basic Motion

Insert a Rotary Motor using the Motion Study tab.

327) Click the **Motion Study 1** tab located in the bottom left corner of the Graphics window. The MotionManager is displayed.

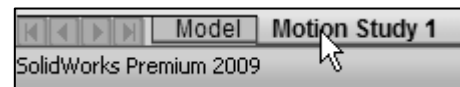

328) Select **Basic Motion** for Type of study from the MotionManager drop-down menu as illustrated.

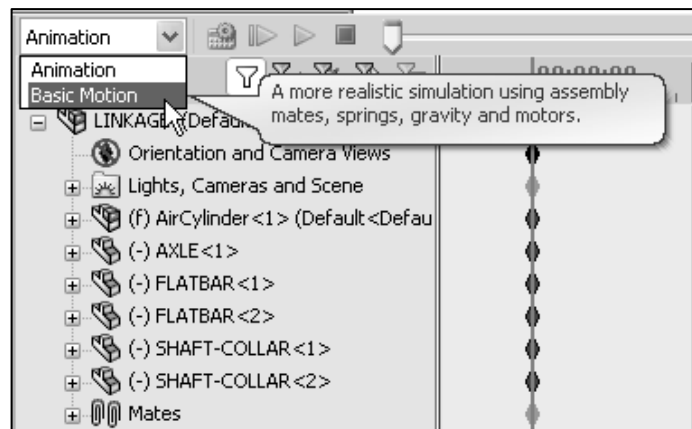

329) Click **Motor**  from the MotionManager. The Motor PropertyManager is displayed.



330) Click the **Rotary Motor** box.

331) Click the **FLATBAR front face** as illustrated. A red Rotary Motor icon is displayed. The red direction arrow points counterclockwise.

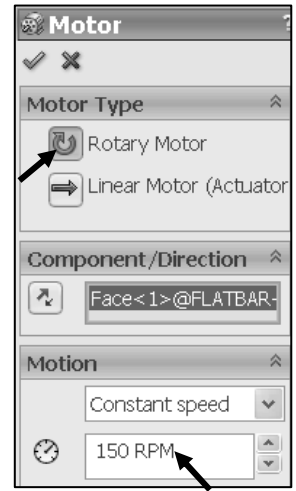
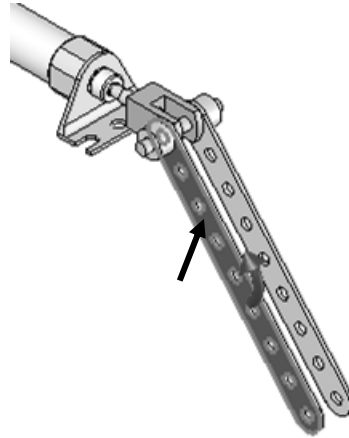

332) Enter **150 RPM** for speed in the Motion box.

333) Click **OK**  from the Motor PropertyManager.

Record the Simulation.

334) Click **Calculate** . The FLATBAR rotates in a counterclockwise direction for a set period of time.

335) Click **Play** . View the simulation.

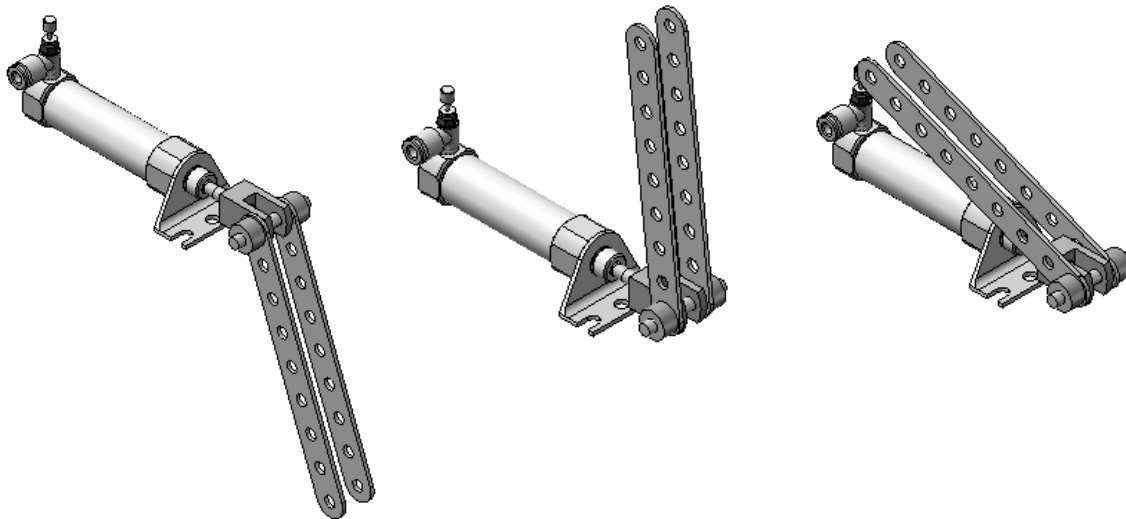

Linear Assembly Basic Simulation

Save the simulation in an AVI file to the SW-TUTORIAL-2009 folder.

336) Click **Save Animation**.



337) Click **Save** from the Save Animation to File dialog box. View your options.

338) Click **OK** from the Video Compression box.

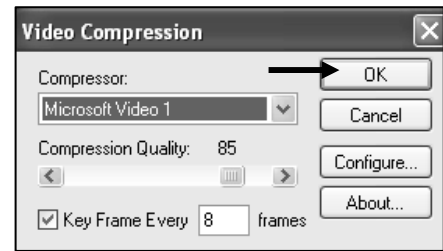

Close the Motion Study and return to SolidWorks.

339) Click the **Model** tab location in the bottom left corner of the Graphics window.

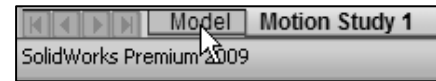

Fit the assembly to the Graphics window.

340) Press the **f** key.

Save the LINKAGE assembly.

341) Click **Save** .

Exit SolidWorks.

342) Click **Windows, Close All** from the Menu bar.

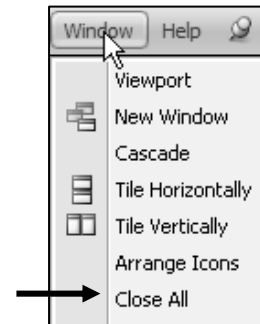

The LINKAGE assembly project is complete.



Review the Motion Study

The Rotary Motor Basic Motion tool combined Mates and Physical Dynamics to rotate the FLATBAR components in the LINKAGE assembly. The Rotary Motor was applied to the front face of the FLATBAR. You utilized the Calculate option to play the simulation. You saved the simulation in an .AVI file.

 Additional details on Motion Study, Assembly, mates, and Simulation are available in SolidWorks Help. Keywords: Motion Study and Basic Motion.

Project Summary

In this project you created three parts, copied the AirCylinder assembly from the CD in the book, and created the LINKAGE assembly.

You developed an understanding of the SolidWorks User Interface: Menus, Toolbars, Task Pane, CommandManager, FeatureManager, System feedback icons, Document Properties, Parts, and Assemblies.

You created 2D sketches and addressed the three key states of a sketch: *Fully Defined*, *Over Defined*, and *Under Defined*. Note: Always review your FeatureManager for the proper Sketch state.

You obtained the knowledge of the following SolidWorks features: Extruded Base, Extruded Cut, and Linear Pattern. Features are the building blocks of parts. The Extruded Boss/Base feature required a Sketch plane, sketch, and depth.

The Extruded Boss/Base feature added material to a part. The Extruded Base feature was utilized in the AXLE, SHAFT-COLLAR, and FLATBAR parts.

The Extruded Cut feature removed material from the part. The Extruded Cut feature was utilized to create a hole in the SHAFT-COLLAR, and FLATBAR parts.

The Linear Pattern feature was utilized to create an array of holes in the FLATBAR part.

When parts are inserted into an assembly, they are called components. You created the LINKAGE assembly by inserting the AirCylinder assembly, AXLE, SHAFT-COLLAR, and FLATBAR parts.

Mates are geometric relationships that align and fit components in an assembly. Concentric, Coincident, and Parallel mates were utilized to assemble the components.

You created a Motion Study. The Rotary Motor Basic Motion tool combined Mates and Physical Dynamics to rotate the FLATBAR components in the LINKAGE assembly.



If an assembly or component is loaded in a Lightweight  state, right-click the **assembly name** or **component name** from the FeatureManager. Click **Set Lightweight to Resolved**.

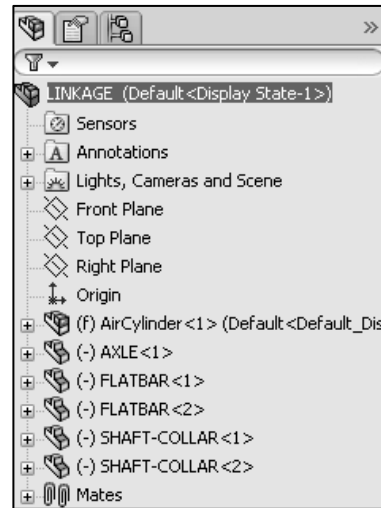

Project Terminology

Utilize SolidWorks Help for additional information on the terms utilized in this project.

Assembly: An assembly is a document which contains parts, features, and other sub-assemblies. When a part is inserted into an assembly it is called a component. Components are mated together. The filename extension for a SolidWorks assembly file name is .SLDASM.

Component: A part or sub-assembly within an assembly.

Cursor Feedback: Feedback is provided by a symbol attached to the cursor arrow indicating your selection. As the cursor floats across the model, feedback is provided in the form of symbols, riding next to the cursor.

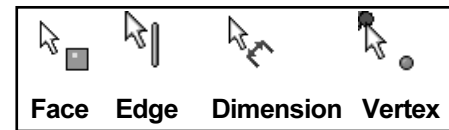

Dimension: A value indicating the size of feature geometry.

Drafting Standard: A set of drawing and detailing options developed by national and international organizations. The Dimensioning standard options are: ANSI, ISO, DIN, JIS, BSI, GOST and GB.

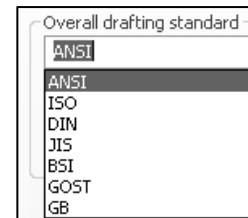

Features: Features are geometry building blocks. Features add or remove material. Features are created from sketched profiles or from edges and faces of existing geometry.

Instance Number: The instance number increments every time you insert the same component or mate. If you delete a component or mate and then reinsert the component or mate in the same SolidWorks session, the instance number increments by one.

Mates: A mate is a geometric relationship between components in an assembly.

Mouse Buttons: The left and right mouse buttons have distinct meanings in SolidWorks. Left mouse button is utilized to select geometry. Right-mouse button is utilized to invoke commands.

Part: A part is a single 3D object made up of features. The filename extension for a SolidWorks part file name is .SLDPRT.

Plane: To create a sketch, select a plane. Planes are flat and infinite. They are represented on the screen with visible edges. The reference plane for this project is the Front Plane.

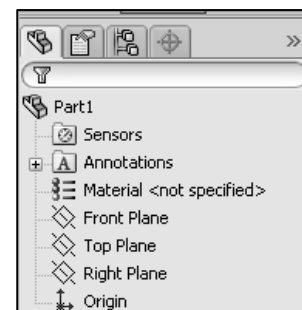
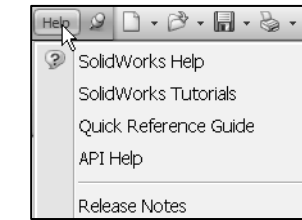

Relation: A relation is a geometric constraint between sketch entities or between a sketch entity and a plane, axis, edge, or vertex.

Sketch: The name to describe a 2D profile is called a sketch. 2D Sketches are created on flat faces and planes within the model. Typical geometry types are lines, arcs, rectangles, circles, polygons and ellipses.

Status of a Sketch: Three states are utilized in this Project:

- *Fully Defined:* Has complete information, (Black), *Over Defined:* Has duplicate dimensions, (Red), or *Under Defined:* There is inadequate definition of the sketch, (Blue).

Toolbars: The toolbar menus provide shortcuts enabling you to quickly access the most frequently used commands.

Trim Entities: Deletes selected sketched geometry. Extends a sketch segment unit it is coincident with another entity.

Units: Used in the measurement of physical quantities. Millimeter dimensioning and decimal inch dimensioning are the two types of common units specified for engineering parts and drawings.

Project Features

Extruded Boss/Base: An Extruded Base feature is the first feature in a part. The Extruded Boss/Base feature starts with either a 2D or 3D sketch. An Extruded Boss feature occurs after the Extruded Base feature. The Extruded Boss/Base feature adds material by extrusion. Steps to create an Extruded Boss/Base Feature:

- Select the Sketch plane; Sketch the profile; Add needed dimensions and Geometric relations; Select Extruded Boss/Base from the Features toolbar; Select an End Condition and/or options; Enter a depth; Click OK from the Extrude PropertyManager.

Extruded Cut: The Extruded Cut feature removes material from a solid. The Extruded Cut feature performs the opposite function of the Extruded Boss/Base feature. The Extruded Cut feature starts with either a 2D or 3D sketch and removes material by extrusion. Steps to create an Extruded Cut Feature:

- Select the Sketch plane; Sketch the profile, Add Dimensions and Relations; Select Extruded Cut from the Features toolbar; Select an End Condition and/or options; Enter a depth; Click OK from the Extrude PropertyManager.



Linear Pattern: A Linear Pattern repeats features or geometry in an array. A Linear Pattern requires the number of instances and the spacing between instances. Steps to create a Linear Pattern Feature:

- Select the features to repeat; Select Linear Pattern from the Feature toolbar; Enter Direction of the pattern; Enter Number of pattern instances in each direction; Enter Distance between pattern instances; Optional: Pattern instances to skip; Click OK from the Linear Pattern PropertyManager.

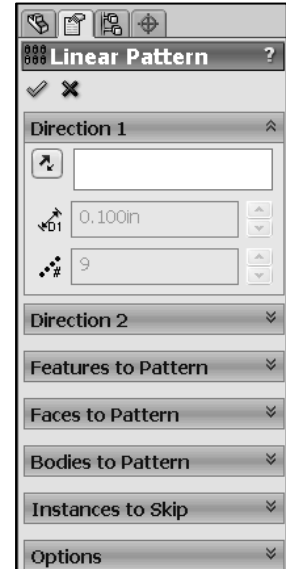

Engineering Journal

Engineers and designers utilize mathematics, science, economics and history to calculate additional information about a project. Answers to questions are written in an engineering journal.

1. Volume of a cylinder is provided by the formula, $V = \pi r^2 h$. Where:

- V is volume.
- r is the radius.
- h is the height.

- Determine the radius of the AXLE in mm.
- Determine the height of the AXLE in mm.
- Calculate the Volume of the AXLE in mm^3 .

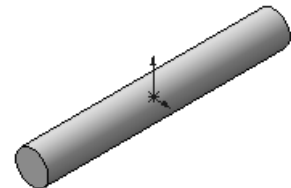

2. Density of a material is provided by the formula: $\rho = m/V$. Where:

- ρ is density.
- m is mass.
- V is volume.

a) Determine the mass of the AXLE in grams if the AXLE is manufactured from hardened steel. The density of hardened steel is $.007842 \text{ g/mm}^3$.

3. The material supplier catalog lists Harden Steel Rod in foot lengths.

Harden Steel Rod (Ø 3/16):		
Part Number:	Length:	Cost:
23-123-1	1 ft	\$10.00
23-123-2	2 ft	\$18.00
23-123-3	3 ft	\$24.00

Utilize the table above to determine the following questions:

How many 1-3/8 inch AXLES can be cut from each steel rod?

Twenty AXLE parts are required for a new assembly. What length of Harden Steel Rod should be purchased?

4. Air is a gas. Boyle’s Law states that with constant temperature, the pressure, P of a given mass of a gas is inversely proportional to its volume, V.

- $P_1 / P_2 = V_2 / V_1$
- $P_1 \times V_1 = P_2 \times V_2$

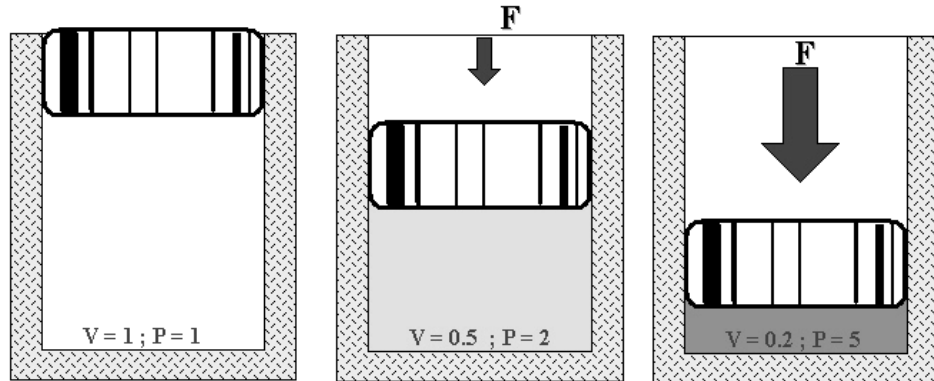

Illustration of Boyle’s Law
 Courtesy of SMC Corporation of America

The pressure in a closed container is doubled. How will the volume of air inside the container be modified?

Robert Boyle (1627-1691) was an Irish born, English scientist, natural philosopher and a founder of modern chemistry. Boyle utilized experiments and the scientific method to test his theories. Along with his student, Robert Hooke (1635-1703), Boyle developed the air pump.

Research other contributions made by Robert Boyle and Robert Hooke that are utilized today.

Questions

1. Explain the steps in starting a SolidWorks session.
2. Describe the procedure to begin a new 2D sketch.
3. Explain the steps required to modify part unit dimensions from inches to millimeters.
4. Describe the procedure to create a simple 3D part with an Extruded Base feature.
5. Identify the three default Reference planes.
6. Describe a Base feature? Provide two examples from this Project.
7. Describe the differences between an Extruded Base feature and an Extruded Cut feature.
8. The sketch color black indicates a sketch is _____ defined.
9. The sketch color blue indicates a sketch is _____ defined.
10. The sketch color red indicates a sketch is _____ defined.
11. Describe the procedure to “wake up” a centerpoint.
12. Define a Geometric relation. Provide an example.
13. Describe the procedure to create a Linear Pattern feature.
14. Describe an assembly or sub-assembly.
15. What are mates and why are they important in assembling components?
16. In an assembly, each component has _____ # degrees of freedom? Name them.
17. True or False. A fixed component cannot move in an assembly.
18. Review the Design Intent section in the book. Identify how you incorporated design intent into the parts and assembly.

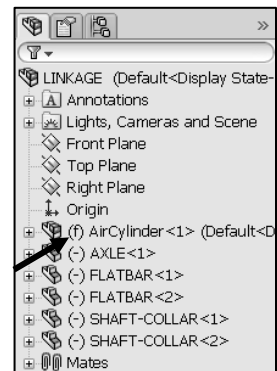
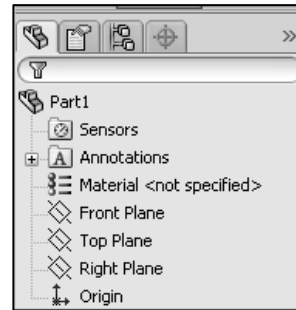
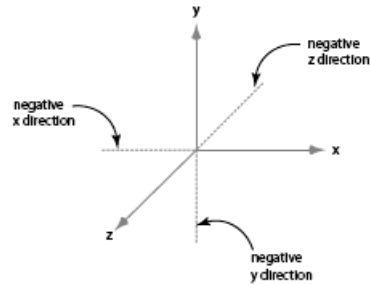
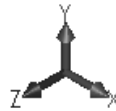

Exercises

Exercise 1.1: Identify the Sketch plane for the Extrude1 (Base) feature as illustrated.

- A: Top Plane
- B: Front Plane
- C: Right Plane
- D: Left Plane

Correct answer _____.

Create the part. Dimensions are arbitrary.

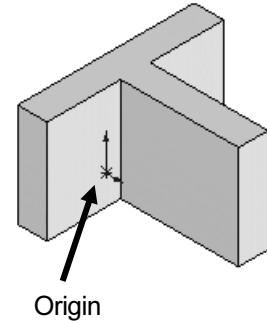

Exercise 1.2: Identify the Sketch plane for the Extrude1 (Base) feature as illustrated.

- A: Top Plane
- B: Front Plane
- C: Right Plane
- D: Left Plane

Correct answer _____.

Create the part. Dimensions are arbitrary.

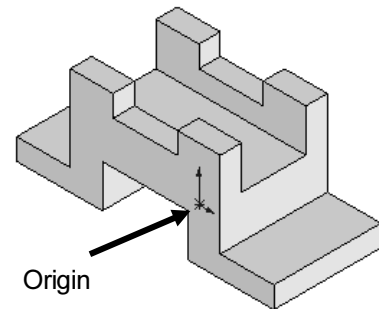

Exercise 1.3: Identify the Sketch plane for the Extrude1 (Base) feature as illustrated.

- A: Top Plane
- B: Front Plane
- C: Right Plane
- D: Left Plane

Correct answer _____.

Create the part. Dimensions are arbitrary.

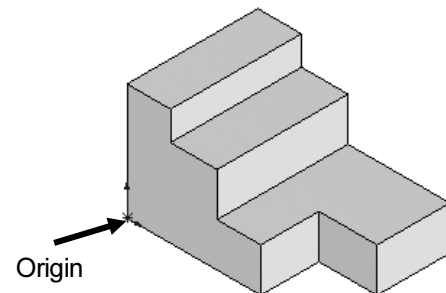

Exercise 1.4: FLATBAR-3HOLE.

Create the FLATBAR-3HOLE part.

- Utilize the Front Plane for the Sketch plane. Insert an Extruded Base feature.
- Create an Extruded Cut feature. This is your seed feature. Apply the Linear Pattern feature. The FLATBAR-3HOLE part is manufactured from 0.060in, [1.5mm] 6061 Alloy.

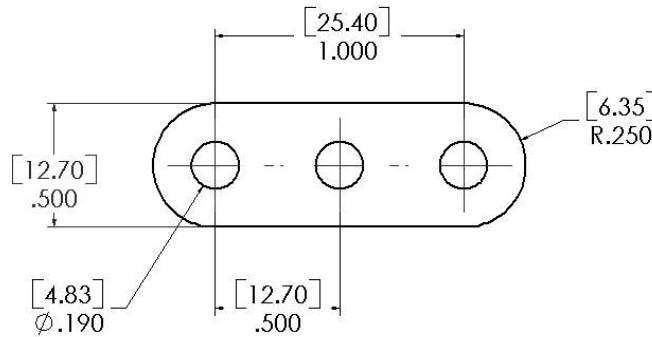
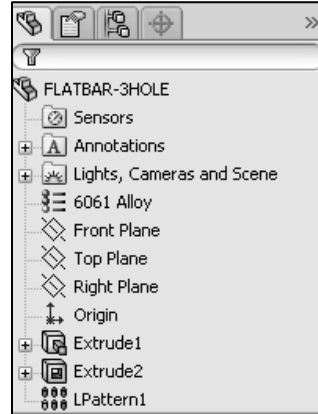

FLATBAR-3HOLE

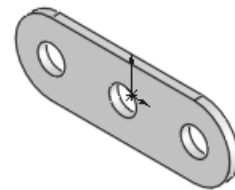

Exercise 1.5: FLATBAR-5HOLE.

Create the FLATBAR-5HOLE part as illustrated.

- Utilize the Front Plane for the Sketch plane. Insert an Extruded Base feature.
- Create an Extruded Cut feature. This is your seed feature. Apply the Linear Pattern feature. The FLATBAR-5HOLE part is manufactured from 0.060in, [1.5mm] 6061 Alloy.
- Calculate the required dimensions for the FLATBAR-5HOLE part. Use the following information: Holes are .500in on center, Radius is .250in, and Hole diameter is .190in.

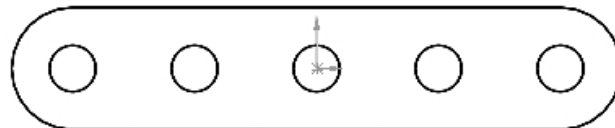
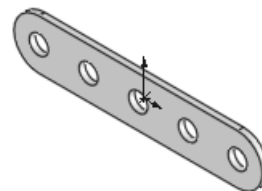

FLATBAR-5HOLE

Exercise 1.6

Create the illustrated part. Note the location of the Origin in the illustration.

- Calculate the overall mass of the illustrated model.
- Apply the Mass Properties tool.
- Think about the steps that you would take to build the model.
- Review the provided information carefully.
- Units are represented in the IPS, (inch, pound, second) system.
- $A = 3.50\text{in}$, $B = .70\text{in}$

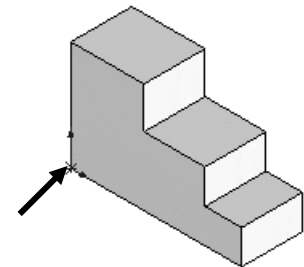
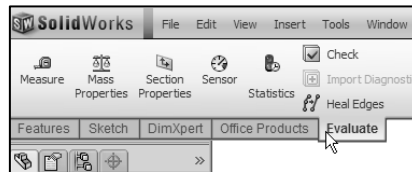
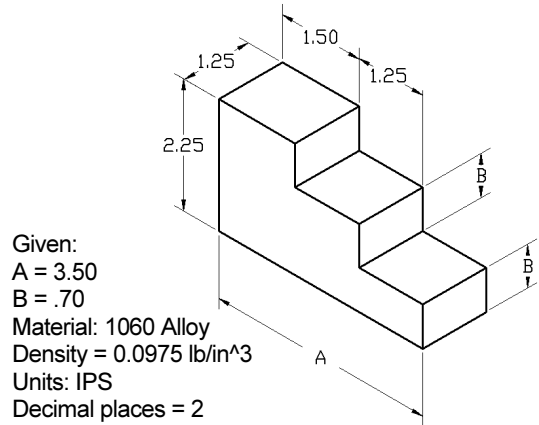

Exercise 1.7

Create the illustrated part. Note the location of the Origin in the illustration.

- Calculate the overall mass of the illustrated model.
- Apply the Mass Properties tool.
- Think about the steps that you would take to build the model.
- Review the provided information carefully. Units are represented in the IPS, (inch, pound, second) system.
- $A = 3.00\text{in}$, $B = .75\text{in}$
- Note: The part is symmetrical.

Given:
 $A = 3.00$
 $B = .75$
 Material: Copper
 Density = 0.321 lb/in^3
 Units: IPS
 Decimal places = 2

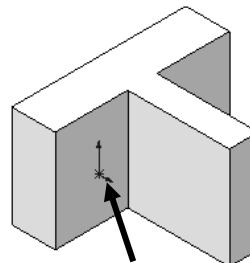
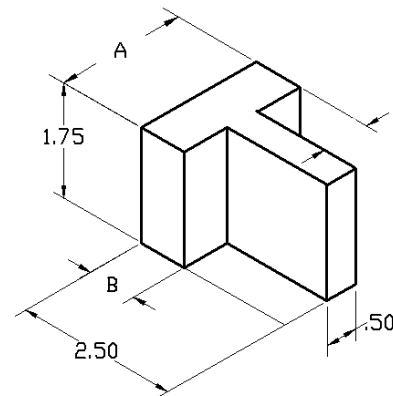

Exercise 1.8

Create the illustrated part. Note the location of the Origin in the illustration.

- Calculate the volume of the part and locate the Center of mass with the provided information.
- Apply the Mass Properties tool.
- Think about the steps that you would take to build the model.
- Review the provided information carefully.

Given:
 A = 3.30
 B = 2.00
 Material: 2014 Alloy
 Density = .101 lb/in³
 Units: IPS
 Decimal places = 2

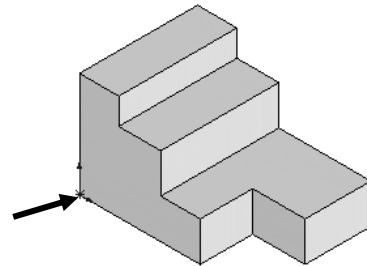
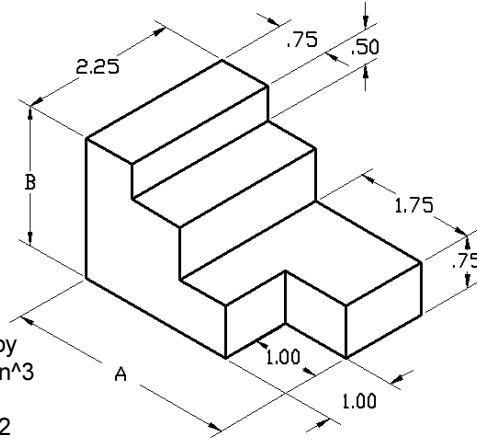

Exercise 1.9

Create the part from the illustrated drawing: Front, Top, Right, and Isometric views. Note: The location of the Origin in the illustration.

- Apply 1060 Alloy for material.
- Calculate the Volume of the part and locate the Center of mass.
- Think about the steps that you would take to build the model. The part is symmetric about the Front Plane.

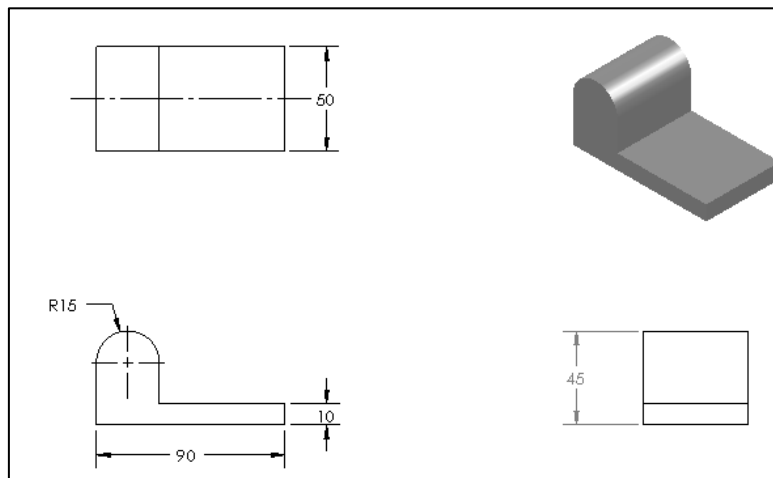
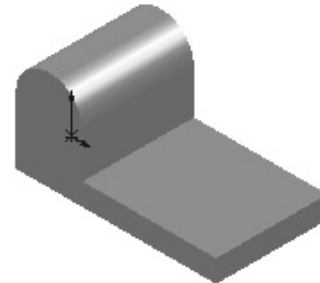

Exercise 1.10

Create the part from the illustrated drawing: Front, Top, Right, and Isometric views.

- Apply 1060 Alloy for material.
- The part is symmetric about the Front Plane.
- Calculate the Volume of the part and locate the Center of mass.
- Think about the steps that you would take to build the model.

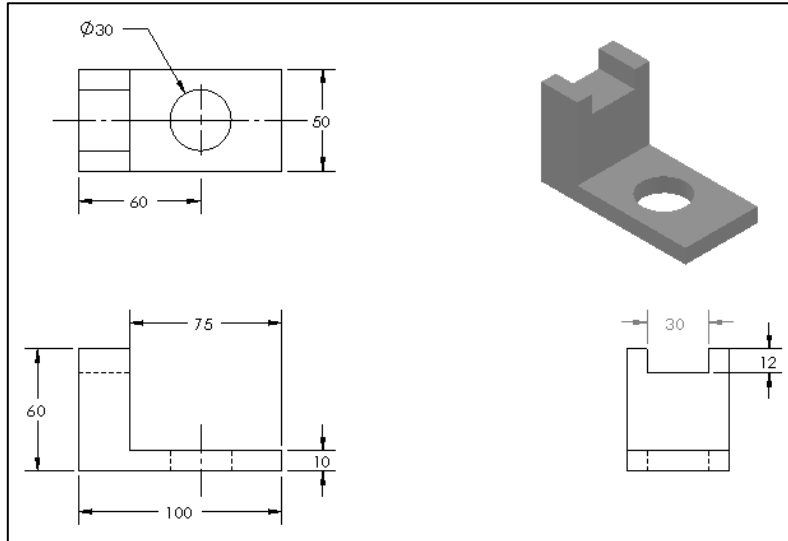
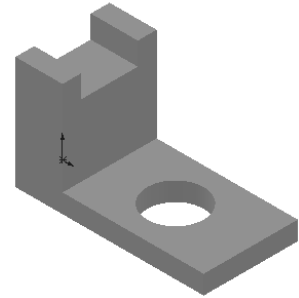

**Exercise 1.11:
LINKAGE-2 Assembly.**

Create the LINKAGE-2 assembly.

- Open the LINKAGE assembly. If required, set the LINKAGE assembly to **(Set Lightweight to Resolved)**.
- Select Save As from the Menu bar.
- Check the Save as copy check box.
- Enter LINKAGE-2 for file name. LINKAGE-2 ASSEMBLY for description.

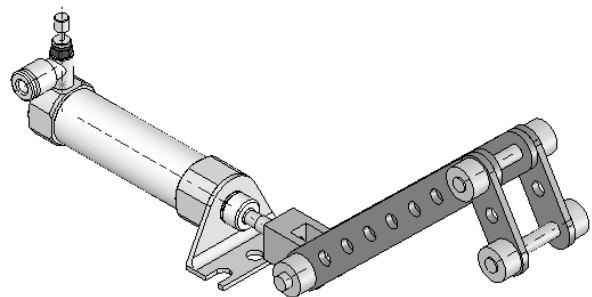
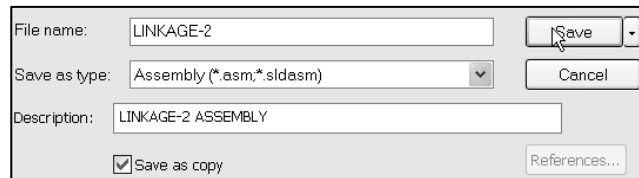
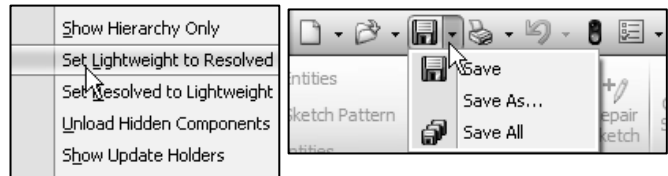

The FLATBAR-3HOLE part was created in Exercise 1.1. Utilize two AXLE parts, four SHAFT COLLAR parts, and two FLATBAR-3HOLE parts to create the LINKAGE-2 assembly as illustrated.

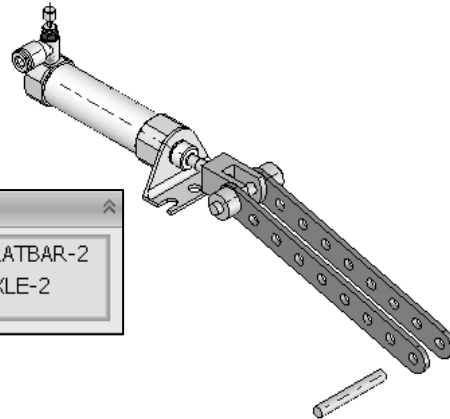

- Insert the first AXLE part.
- Insert a Concentric mate.

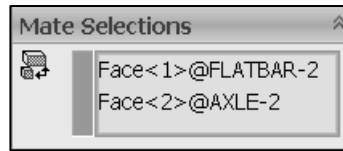

- Insert a Coincident mate.

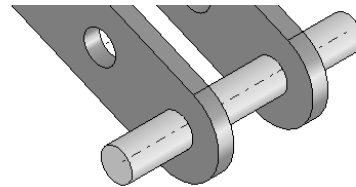

- Insert the first FLATBAR-3HOLE part.

- Insert a Concentric mate.

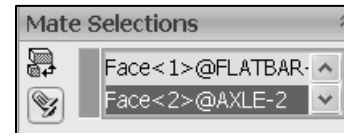

- Insert a Coincident mate.

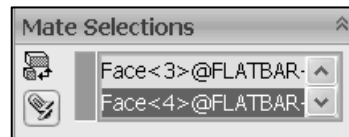
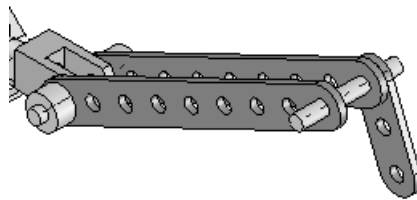

- Perform the same procedure for the second FLATBAR-3HOLE part.

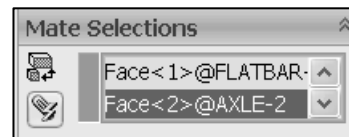
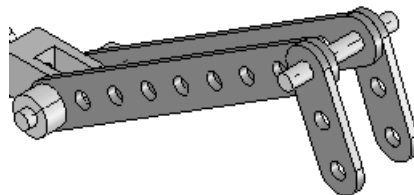

- Insert a Parallel mate between the 2 FLATBAR-3HOLE parts. Note: The 2 FLATBAR-3HOLE parts move together.

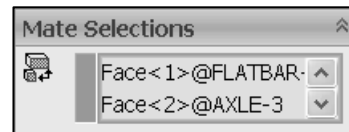
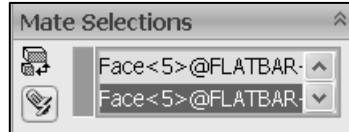

- Insert the second AXLE part.
- Insert a Concentric mate.
- Insert a Coincident mate.
- Insert the first SHAFT-COLLAR part.
- Insert a Concentric mate.
- Insert a Coincident mate.
- Perform the same tasks to insert the other three required SHAFT-COLLAR parts as illustrated.

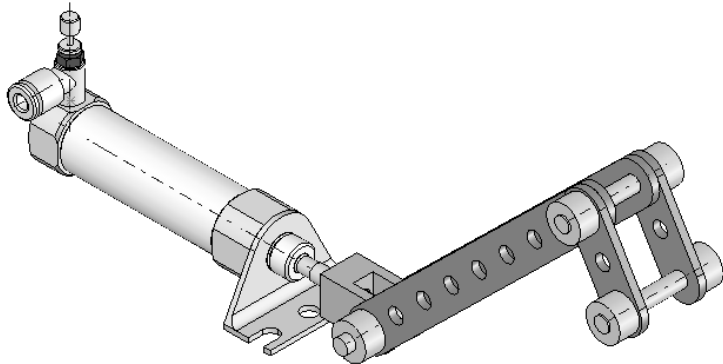
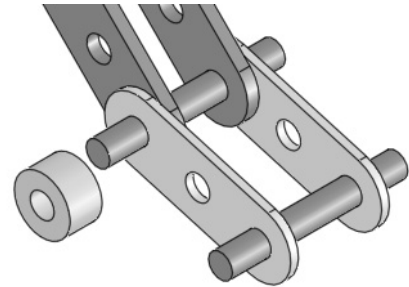
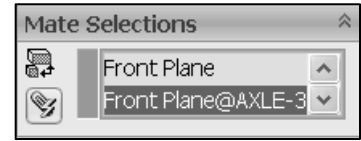
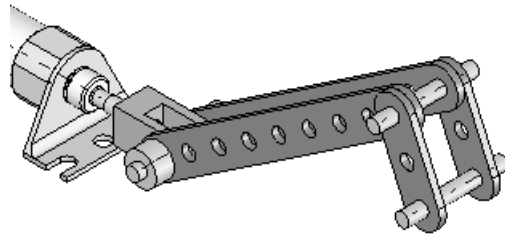

Exercise 1.12: LINKAGE-2 Assembly Motion Study.

Create a Motion Study using the LINKAGE-2 Assembly that was created in the previous exercise.

- Create a Basic Motion Study.
- Apply a Rotary Motor to the front FLATBAR-3HOLE as illustrated.
- Play and Save the Simulation.

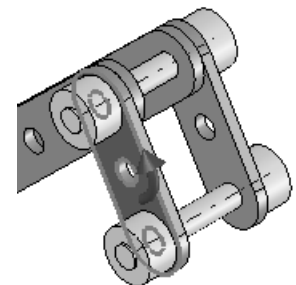
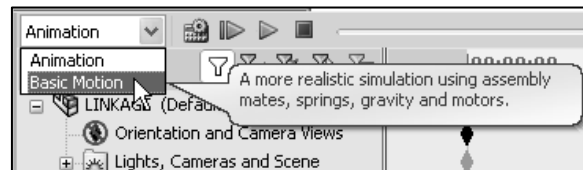

Exercise 1.13: ROCKER Assembly.

Create a ROCKER assembly. The ROCKER assembly consists of two AXLE parts, two FLATBAR-5HOLE parts, and two FLATBAR-3HOLE parts.

The FLATBAR-3HOLE parts are linked together with the FLATBAR-5HOLE.

The three parts rotate clockwise and counterclockwise, above the Top Plane. Create the ROCKER assembly.

- Insert the first FLATBAR-5HOLE part. The FLATBAR-5HOLE is fixed to the Origin of the ROCKER assembly.
- Insert the first AXLE part.
- Insert a Concentric mate.
- Insert a Coincident mate.
- Insert the second AXLE part.
- Insert a Concentric mate.
- Insert a Coincident mate.
- Insert the first FLATBAR-3HOLE part.
- Insert a Concentric mate.
- Insert a Coincident mate.
- Insert the second FLATBAR-3HOLE part.
- Insert a Concentric mate.
- Insert a Coincident mate.

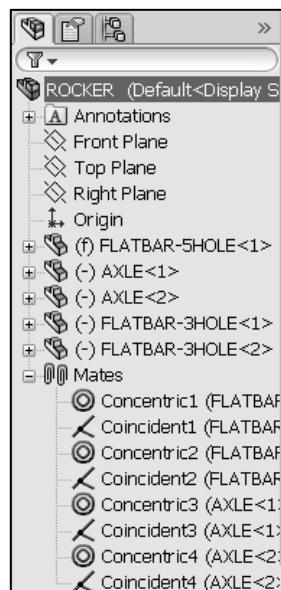
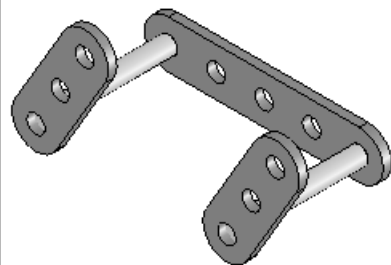
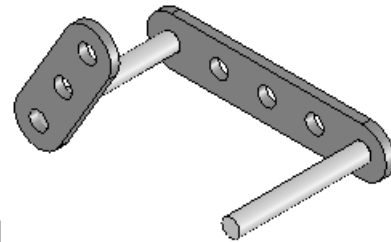
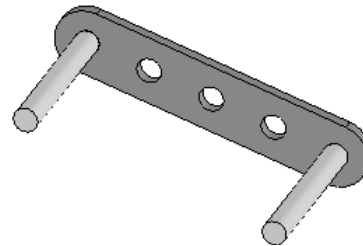
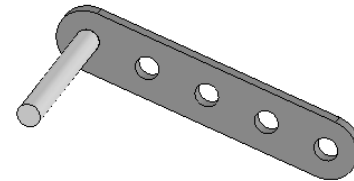
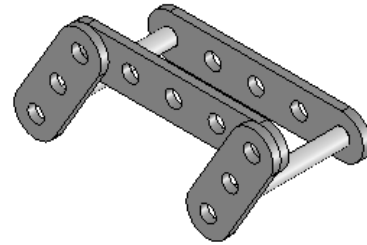

- Insert the second FLATBAR-5HOLE part.
- Insert the required mates.

Note: The end holes of the second FLATBAR-5HOLE are concentric with the end holes of the FLATBAR-3HOLE parts.

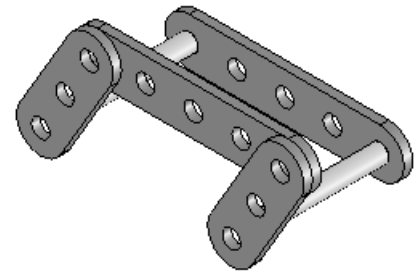

Note: In mechanical design, the ROCKER assembly is classified as a mechanism. A Four-Bar Linkage is a common mechanism comprised of four links.

Link1 is called the Frame.

The AXLE part is Link1.

Link2 and Link4 are called the Cranks.

The FLATBAR-3HOLE parts are Link2 and Link4. Link3 is called the Coupler.
The FLATBAR-5HOLE part is Link3.

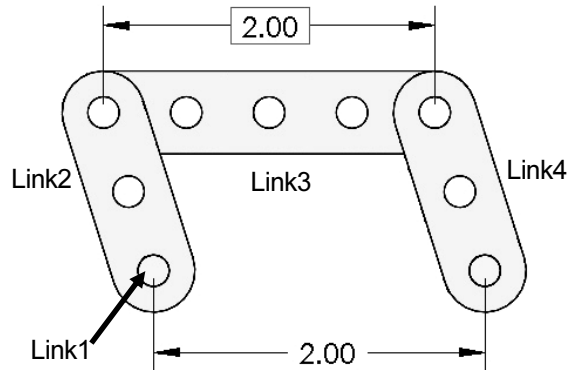

 If an assembly or component is loaded in a Lightweight state, right-click the **assembly name** or **component name** from the FeatureManager. Click **Set Lightweight to Resolved**.

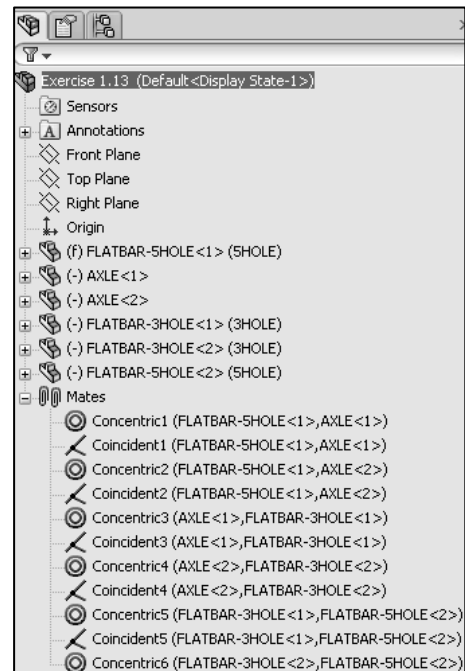

Exercise 1.14: Industry Application.

Engineers and designers develop a variety of products utilizing SolidWorks.

Model information is utilized to create plastic molds for products from toys to toothbrushes.

- Utilize the World Wide Web and review the following web sites: mikejwilson.com and zxys.com.

The models obtained from these web sites are for educational purposes only.

Learn modeling techniques from others; create your own designs. A common manufacturing procedure for plastic parts is named the Injection Molding Process. Today's automobiles utilize over 50% plastic components.

Engineers and designers work with mold makers to produce plastic parts. Cost reduction drives plastic part production.

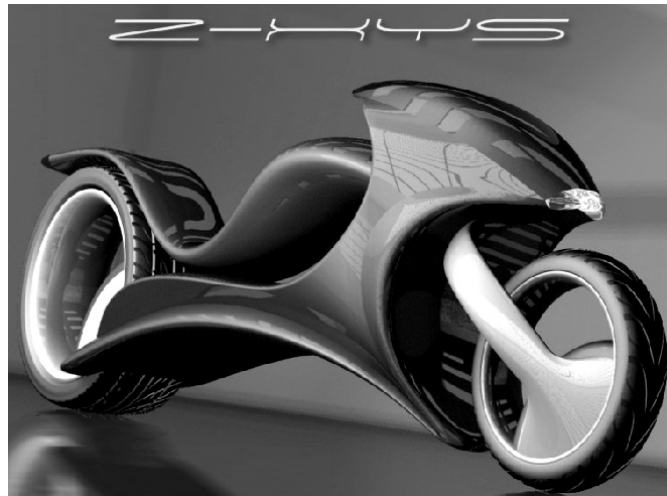

Model Courtesy of
Mike J. Wilson,
CSWP

