

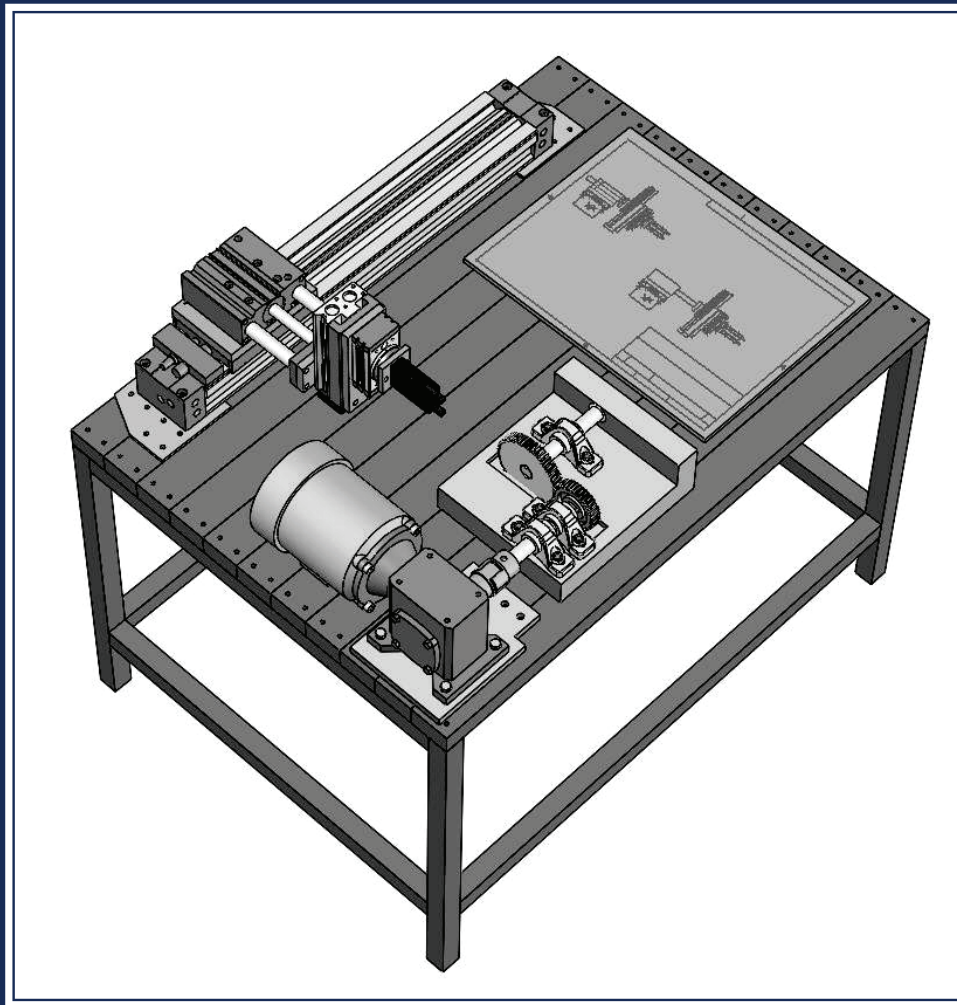

Assembly Modeling with SolidWorks 2010

For the SolidWorks user that needs to understand Assembly Modeling

David C. Planchard & Marie P. Planchard



SDC
PUBLICATIONS

www.SDCpublications.com

Schroff Development Corporation

SolidWorks

Solution
Partner

Chapter 3

Assembly Modeling - Bottom-up design approach

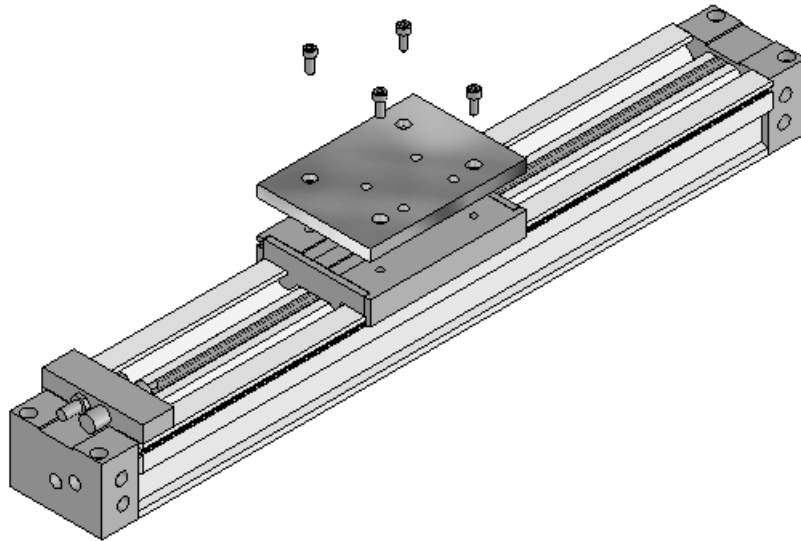

Below are the desired outcomes and usage competencies based on the completion of this Chapter.

Chapter Desired Outcomes:	Usage Competencies:
<ul style="list-style-type: none"> • PLATE-A part 	<ul style="list-style-type: none"> • Knowledge to create new parts based on component features utilizing the Bottom-up design approach
<ul style="list-style-type: none"> • LINEAR-TRANSFER assembly 	<ul style="list-style-type: none"> • Ability to insert and edit components • Comprehension of the Measure tool
<ul style="list-style-type: none"> • Standard and SmartMates Mates 	<ul style="list-style-type: none"> • Capacity to apply the Mate and SmartMate tools
<ul style="list-style-type: none"> • Four M8 x 1.25 Socket Head Cap Screws 	<ul style="list-style-type: none"> • Aptitude to modify and obtain components from the SolidWorks Toolbox

Notes:



Chapter 3 - Assembly Modeling - Bottom-up design approach

Chapter Objective

Develop the LINEAR-TRANSFER assembly. The LINEAR-TRANSFER assembly is the first assembly in the 3AXIS-TRANSFER assembly.

Create the following models in this chapter:

- PLATE-A part
- LINEAR-TRANSFER assembly

On the completion of this chapter, you will be able to:

- Apply the Bottom-up design assembly modeling approach.
- Identify Standard, Advanced, and Mechanical Mate types.
- Utilize SmartMates to assemble the PLATE-A part to the RODLESS-CYLINDER assembly.
- Obtain the required dimensions, and identify the required features in mating components.
- Insert components into an assembly.
- Modify a Distance Mate.
- Address Suppress/Un-suppress and Rigid/Flexible states in a configuration.
- Work with the SolidWorks Design Library.
- Utilize and apply the following SolidWorks tools and commands:
 - Mate, Mate Types, Mate Reference and SmartMate
 - Rotate Component and Move Component
 - Hide / Show components

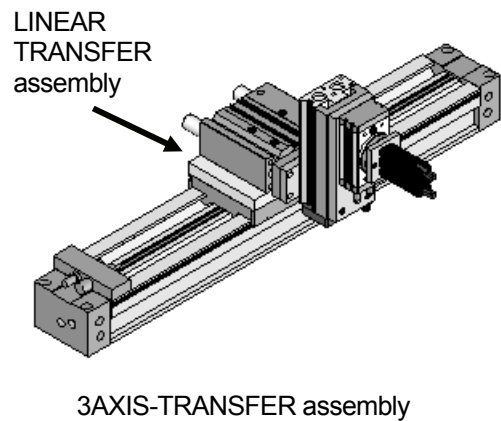
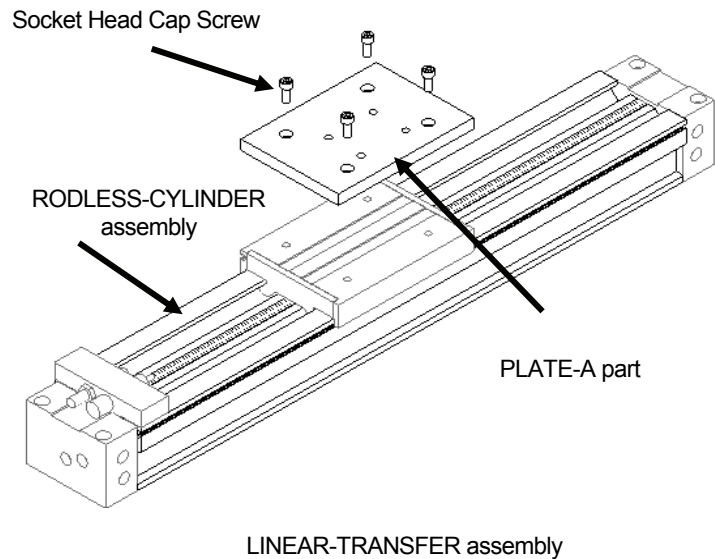

- Flexible and Rigid states
- Collision Detection
- Linear Pattern, and Derived Component Pattern
- SolidWorks Task Pane, Design Library and Toolbox
- Insert Part and Insert Component
- Sketch tools: Corner Rectangle, Center Rectangle, Centerline and Dimension
- Geometric relations: Midpoint, Equal, Vertical and Horizontal
- Views: Section, Isometric, Front, Top and Right
- Features: Extruded Base, Extruded Boss, Extruded Cut and Hole Wizard

Chapter Overview

Bottom-up design is the traditional assembly method. You first design and model parts; then insert them into an assembly and apply Mates to position the parts. To modify the parts, you must edit them individually. These changes; are then seen in the assembly.

The three major steps in a Bottom-up design approach are:

1. Create each component independent of any other component in the assembly.
2. Insert the components into the assembly.
3. Mate the components in the assembly as they relate to the physical constraints of the design.

The geometry and functionality of the PLATE-A part is dependent on the GUIDE-CYLINDER assembly and the RODLESS-CYLINDER assembly.

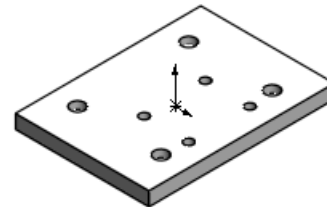
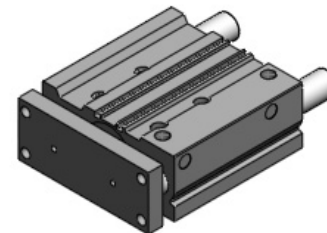
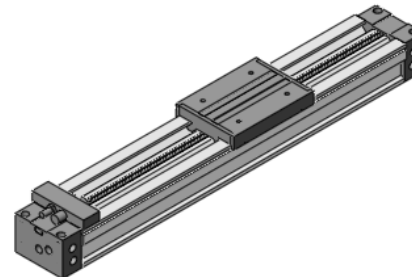



PLATE-A



GUIDE-CYLINDER



RODLESS-CYLINDER

 The GUIDE-CYLINDER and RODLESS-CYLINDER assemblies are located in the SMC folder in the Task Pane.

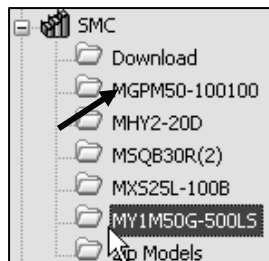

The mounting holes in the GUIDE-CYLINDER are not aligned to the mounting holes of the RODLESS-CYLINDER.

The new PLATE-A part utilizes design criteria from the two assemblies to locate two sets of holes.

Utilize a Bottom-up design approach to develop the LINEAR-TRANSFER assembly. The LINEAR-TRANSFER assembly consists of the following:

- RODLESS-CYLINDER assembly, (located in the SMC file folder).
- PLATE-A part, (create the new part in SolidWorks).
- Four M8 x 1.25 Socket Head Cap Screws, (located in the SolidWorks Toolbox).
- Identify the design components.
- Identify the purchased components.
- Identify the library components.

 To use the SolidWorks Toolbox, click **Add-Ins..** from the Menu bar toolbar. Check **SolidWorks Toolbox** and **SolidWorks Toolbox Browser** from the Add-Ins dialog box. Click **OK**.

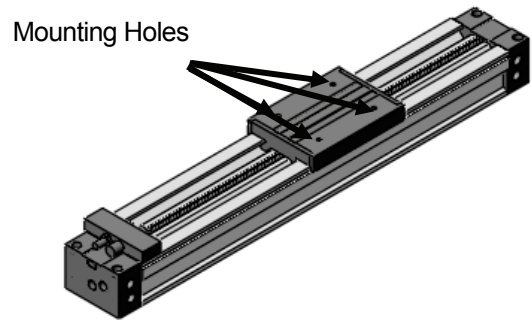
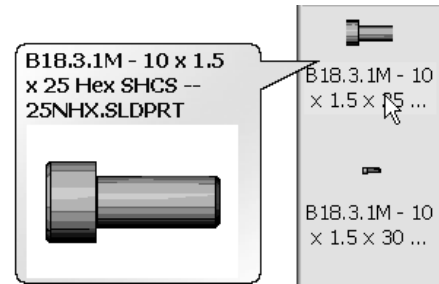
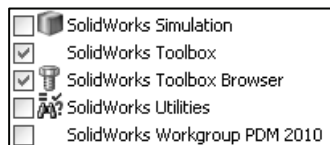

RODLESS-CYLINDER

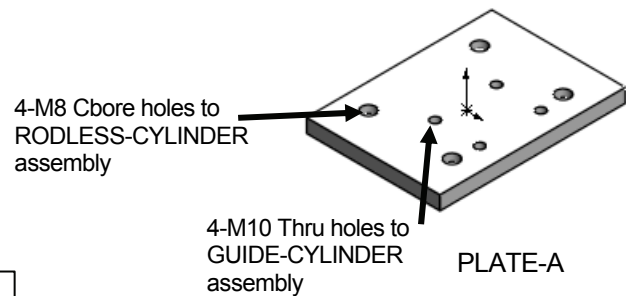
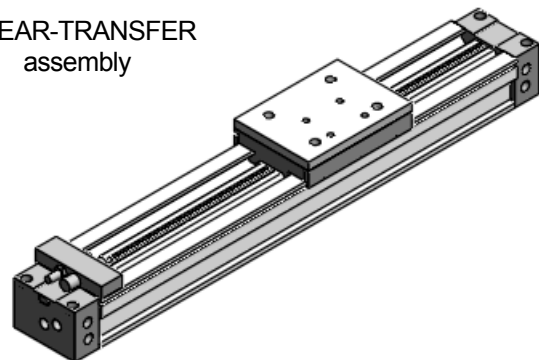

PLATE-A

LINEAR-TRANSFER assembly



Create the PLATE-A part. Assemble PLATE-A to the RODLESS-CYLINDER assembly. Use four, M8 x 1.25 Socket Head Cap Screw (SHCS) to fasten the PLATE-A part to the RODLESS-CYLINDER assembly.

Determine the required length of the SHCS by analyzing the components in the LINEAR-TRANSFER assembly. The M8 x 1.25 SHCS is defined as follows:

- M8 represents a metric screw: 8mm major outside diameter.
- 1.25 thread pitch (mm per thread).

In the next Chapter, develop three configurations for the RODLESS-CYLINDER assembly and three configurations for the LINEAR-TRANSFER assembly.

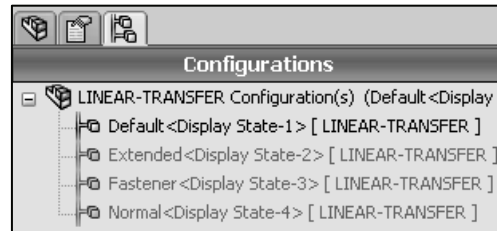
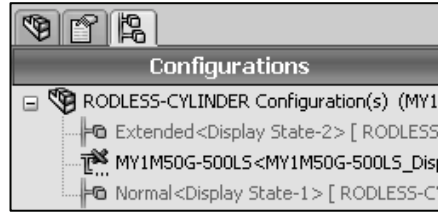



Geometric and Functional Requirements of the PLATE-A part

The PLATE-A part contains five features as illustrated by the illustrated FeatureManager.

Determine the geometric and functional requirements for PLATE-A.

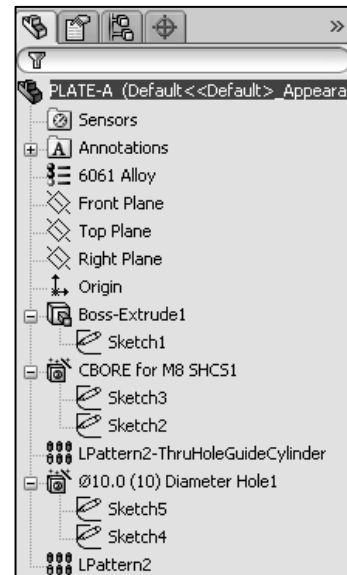
Remember, you will assemble PLATE-A to the RODLESS-CYLINDER assembly.



 This chapter contains thousands of assemblies, parts, features, Mate types, and sketches. Know and understand your file and folder locations.

 Use the FeatureManager to understand your present model condition.

 The Origin is displayed for an educational purpose.

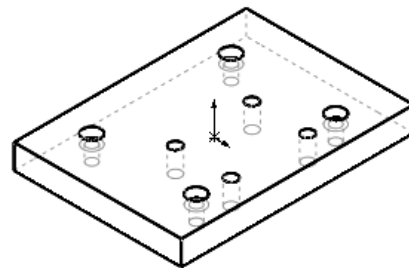

Example 1: The PLATE-A part is contained in the LINEAR-TRANSFER assembly. The FeatureManager full name of the PLATE-A part is: LINEAR-TRANSFER\PLATE-A.

- LINEAR-TRANSFER is the assembly name.
- PLATE-A is the component name.

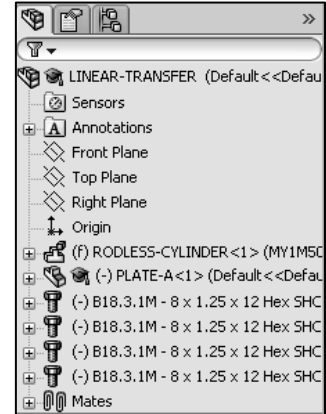

Example 2: Sketch3 is the sketch name of the M8 Cbore Hole. The FeatureManager full name of Sketch3 is LINEAR-TRANSFER\PLATE-A\CBORE for M8 SHCS1\Sketch3.

- LINEAR-TRANSFER is the assembly name.
- PLATE-A is the part name.
- CBORE for M8 SHCS1 is the feature name.
- Sketch3 is the sketch name.

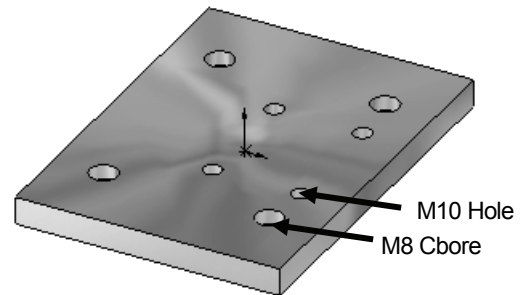

 CBORE is the abbreviation for Counterbore.

 Right-click the assembly name in the FeatureManager and click Set Lightweight to Resolved to fully resolve the Assembly.

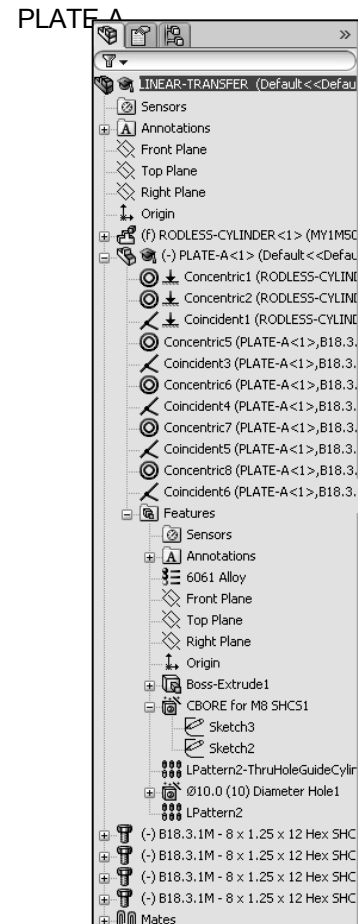

Before you begin a part, review the following New Part Task List.

New Part Task List - Before you begin:		
Task:	Comments:	Complete:
Identify the part function.	PLATE-A combines the RODLESS-CYLINDER with the GUIDE-CYLINDER in the LINEAR-TRANSFER assembly.	✓
Identify the components that directly affect the part.	RODLESS-CYLINDER, GUIDE-CYLINDER and M8 SHCS parts	✓
Research the company component database. Identify if PLATE-A, or a similar part exists.	No. Always verify that the existing part does not exist. Copy similar parts to save model time.	✓
Identify the Mate references in the assembly.	Utilize two Concentric Mates between mating holes. Utilize a Coincident Mate between the bottom face of PLATE-A and the top face of the RODLESS-CYLINDER.	✓
Define the material, units, tolerance and precision. Utilize the Custom Part Template.	Aluminum. Use company default standard tolerance and precision values for all machined parts.	✓
Identify the geometric requirements of the part; width, height, depth, hole locations, etc.	Utilize the Measure tool	partial
Is the part symmetrical? Yes, design with symmetry in the sketch of the base feature.		
Design for changes.		
Identify Features and Mates with descriptive names.		
Group Fillets, Draft, and Patterns together. Reuse geometry. Locate the seed feature in a pattern to be utilized in a component pattern.		
Will this part be used in another assembly? Design for multiple configurations. Create a simplified version with no Fillets, no Draft or on unnecessary features.		
Utilize patterns to be referenced in the assembly and suppressed.		
Obtain a unique filename.	PLATE-A (45-63421). Utilize PLATE-A assigned part number.	✓

Six of the new part tasks are completed. You have some work to do! Determine the Geometric requirements for the PLATE-A part from the size and shape of the following features:

- *GUIDE-CYLINDER\MGPM50-100100_MGPTube\Cbores*
- *GUIDE-CYLINDER\MGPM50-100100_MGPTube\ThruHoles*
- *RODLESS-CYLINDER\MY1M50G-500LS_MY1M2104Table\Table*
- *RODLESS-CYLINDER MY1M50G-500LS_\MY1M2104Table\Table_Holes*

In the first activity, determine the location of the *MGPM50-100100_MGPTube\Cbores* and *MGPM50-100100_MGPTube\ThruHoles*.

In the second activity, determine the proper overall size of the *RODLESS-CYLINDER\MY1M50G-500LS_MY1M2104Table\Table* and the location of the *Table_Holes*.

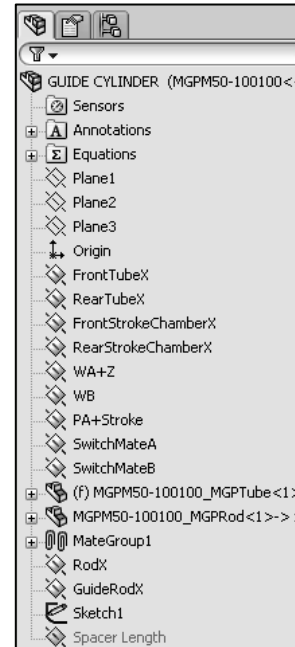

 Quickly locate entries in the FeatureManager by using the filter tool. Rename Features, Mates, and Reference Geometry with descriptive names.

The ThruHoles feature defines the Thru Hole position and diameter. Record the dimensions for the CBORES and ThruHoles features. Avoid precision and tolerance stack-up issues. Perform the following tasks:

- *Set the precision to the appropriate number of decimal places*
- *Mate two diagonal holes between PLATE-A and the MGPTube\ThruHoles*

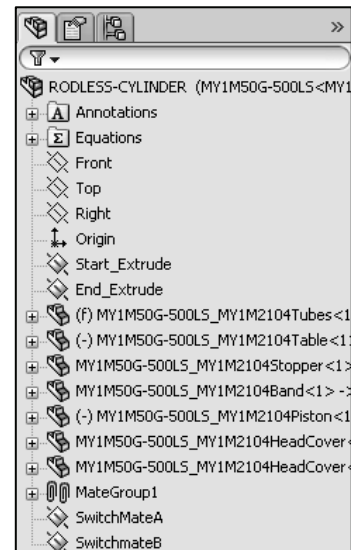

In modeling, utilize Concentric Mates (places the selections so that they share the same center line) with any two sets of holes. Mating the diagonal holes simulates the shop floor practice to utilize diagonal holes for the best stability and clamping.

 The SMC components (downloaded from 3D ContentCentral) utilize an ISO dimensions standard.

 Large assemblies can contain models with legacy data (inherited older models).

Activity: Geometric and Functional Requirements – PLATE-A and GUIDE-CYLINDER Assembly

Open the GUIDE-CYLINDER assembly.

- 1) Click the **Design Library**  tab.
- 2) **Expand** the SMC folder.
- 3) Click the **MGPM50-100100** folder.
- 4) Click and drag the **GUIDE-CYLINDER** icon into the Graphic window. The GUIDE-CYLINDER assembly is displayed.

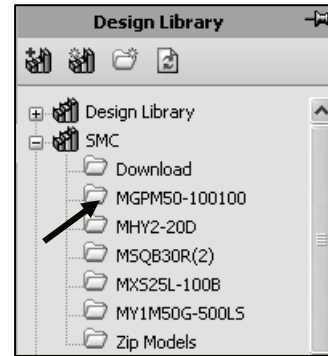

Open the MGPTube part.

- 5) Right-click **MGPTube** from the FeatureManager.
- 6) Click **Open Part** from the Context toolbar. The MGPTube is displayed in the Graphics window.

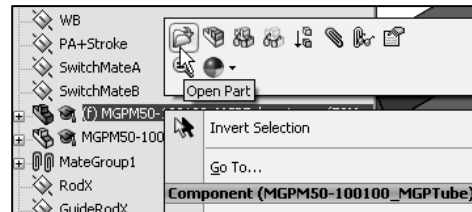

Locate the Cbores and ThruHoles features.

Expand the features.

- 7) **Expand** ThruHoles and Cbores. Sketch15 and Sketch16 are fully defined. Sketch 15 contain External References as indicated by the '->' symbol.

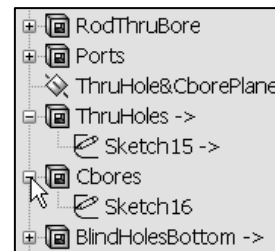

An External reference is created when one document is dependent on another document for its solution. If the referenced document changes, the dependent document changes also.



To create a new feature or part in an assembly without External References, check **Options, External References, Do not create references external to the model** from the System Options dialog box.

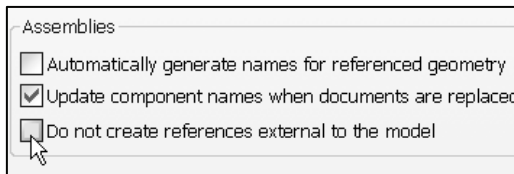

Know the default SW colors. A selected feature in the Graphics window is displayed in blue. The corresponding feature entry in the FeatureManager is displayed in blue. Fully defined sketched dimensions are displayed in black. Extruded depth dimensions are displayed in blue. Modify default colors, check **Options, System Options, Colors, System colors** from the System Options dialog box.

Apply the Measure tool.

- 8) Click the **Evaluate** tab from the CommandManager.
- 9) Click the **Measure**  tool from the Evaluate toolbar.
- 10) Click the **right face** as illustrated. Face<1> is displayed.
- 11) Click the **front face** as illustrated. Face<2> is displayed.

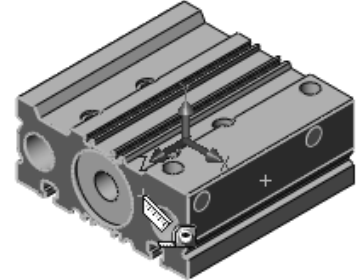
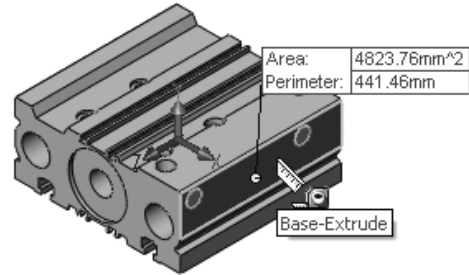

De-select the selected faces.

- 12) Right-click in the **selected box**.
- 13) Click **Clear Selections**.

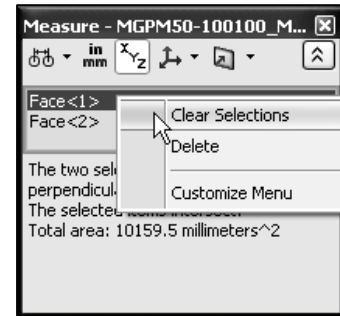

Measure the distance between the back left Cbore to the back right Cbore.

- 14) Click the **back left Cbore cylindrical face**.
- 15) Click the **back right Cbore cylindrical face**. The center distance is 66mm.

Close the open documents.

- 16) Click **Close** from the Measure box.
- 17) Click **Window, Close All** from the Menu bar menu.
- 18) Click **No** to Save changes.

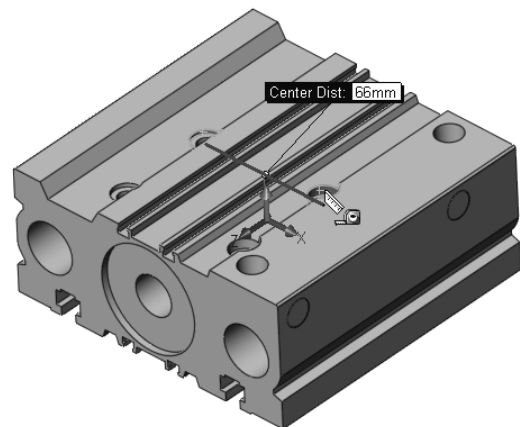
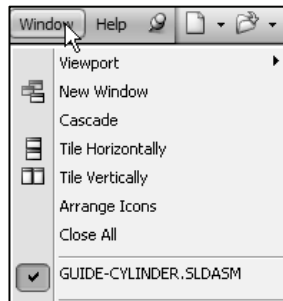

Review the hole placement. Vertical: $72\text{mm} - 24\text{mm} = 48\text{mm}$.
Horizontal: 66mm on center.

Review the hole type: Cbore: $\varnothing 14$. Thru Hole: $\varnothing 8.6$. Common Metric fastener required.

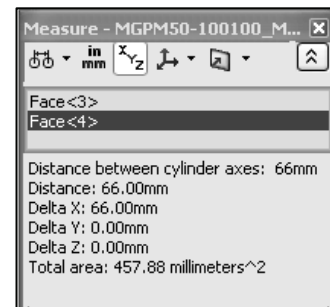

The SolidWorks Measure tool contains the following options:

- *Arc/Circle Measurements*
- *Units/Precision*
- *Show XYZ Measurements*
- *XYZ Relative To*
- *Projected On*

The XYZ coordinates display different results. Select a vertex to display the XYZ coordinates in the Status bar. Select the Show XYZ Measurements option to display dX, dY or dZ.

Un-Select the Show XYZ Measurements option to display the center distance between two selected entities.

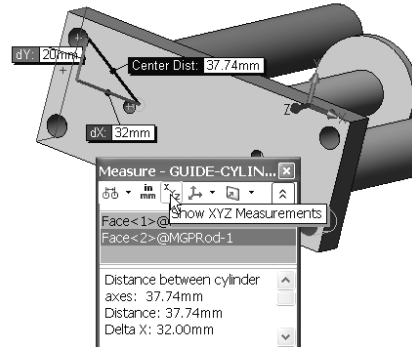
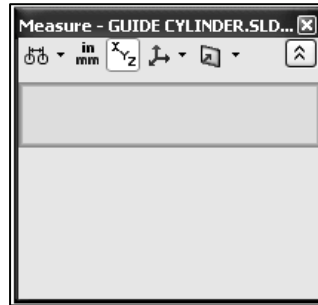

Activity: Geometric and Functional Requirements - PLATE-A and RODLESS-CYLINDER

Open the RODLESS-CYLINDER assembly.

- 19) Click the **SMC\MY1M50G-500LS** folder from the Design Library.
- 20) Click and drag the **RODLESS-CYLINDER** icon into the Graphic window.
- 21) If needed, click **Yes** to rebuild. The RODLESS-CYLINDER assembly is displayed in the Graphics window.

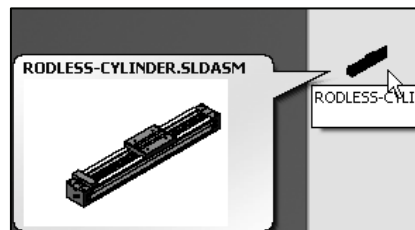
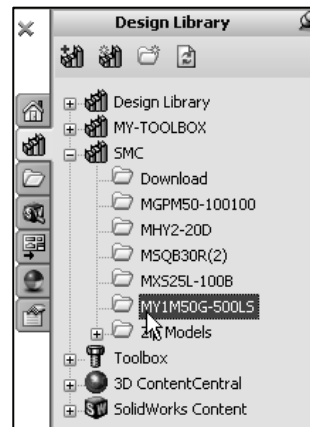

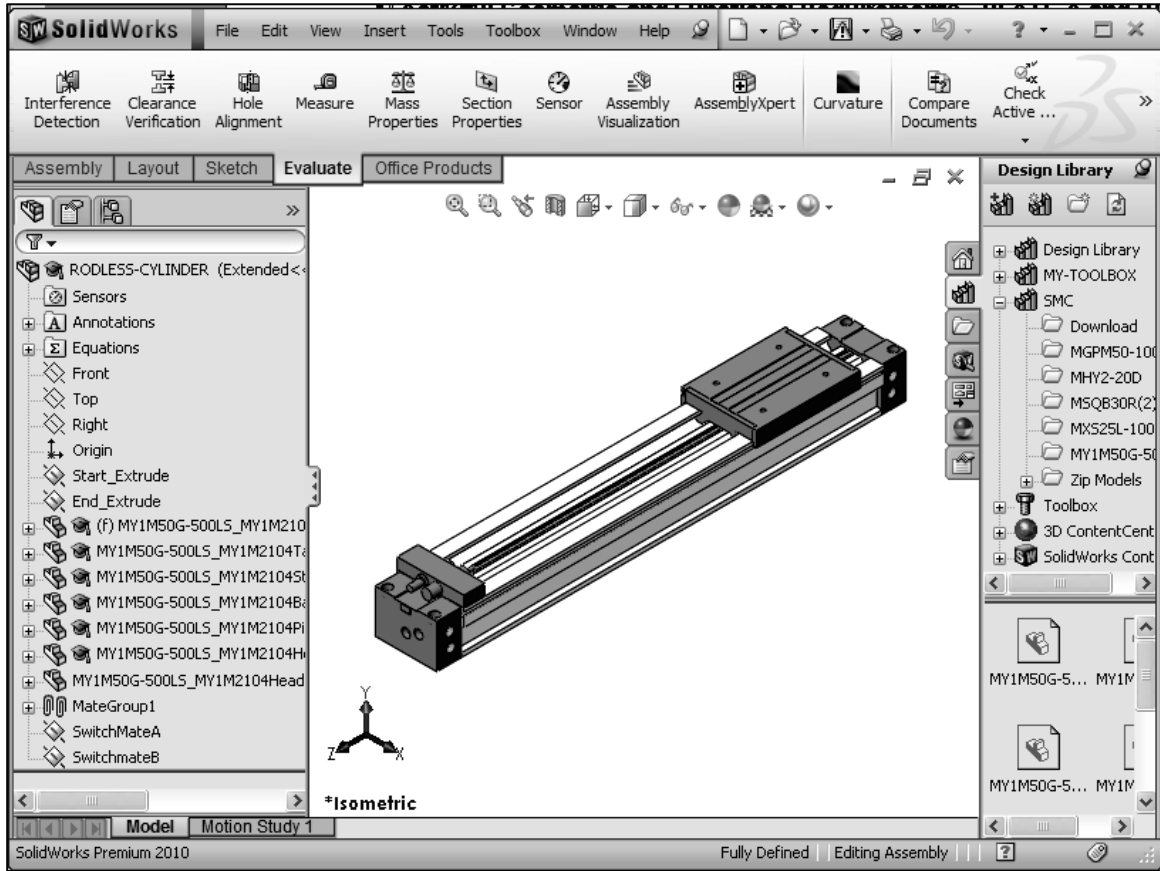

Open the MY1M2104Table.

22) Right-click **MY1M50G-500LS_MY_1M2104Table<1>** from the FeatureManager.

23) Click **Open Part** from the Context toolbar. The table is displayed in the Graphics window.

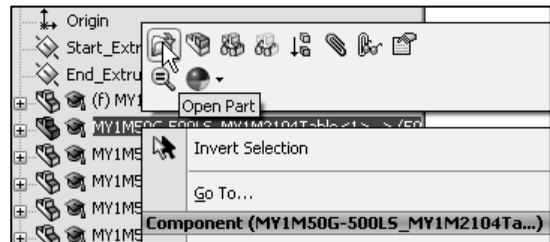

Display an Isometric view in the Graphics window.

24) Click **Isometric** view from the Heads-up View toolbar.

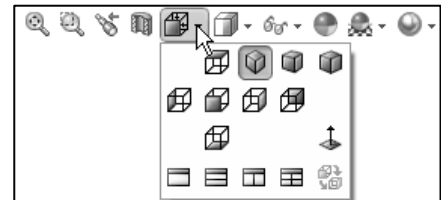

 Right-click the assembly name in the FeatureManager and click **Set Lightweight to Resolved** to fully resolve the Assembly.

Locate the Table features.

25) Position the **mouse pointer** on the right side of the Table. The feature tool tip Table is displayed. Table is an Extruded Base (Boss-Extrude1) feature.

26) Position the **mouse pointer** on the top-hole circumference. The feature tool tip Table_Holes is displayed.

Close the MY1M2104Table.

27) Click **File, Close** from the Menu bar menu. The RODLESS-CYLINDER remains open.

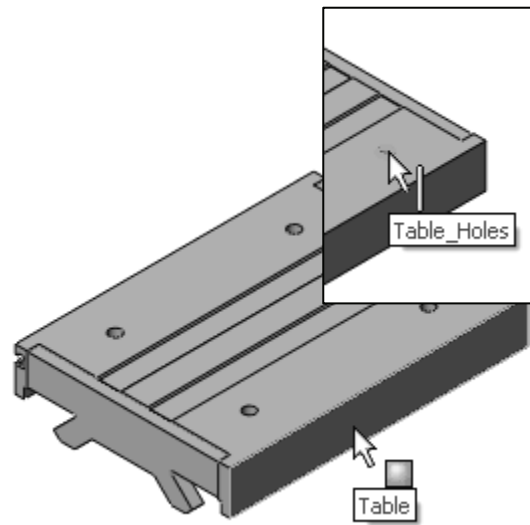

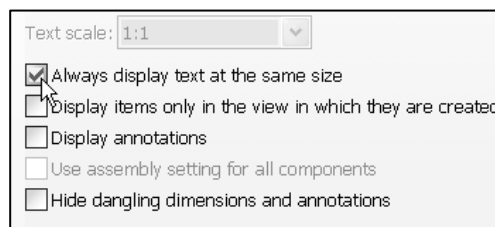
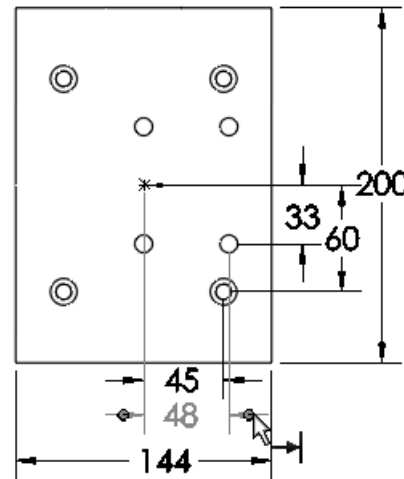

PLATE-A part

The dimensions in the mating parts determine the feature dimensions in PLATE-A. At this time, the Table_Holes are not aligned with the GUIDE-CYLINDER Cbore Holes. PLATE-A requires two patterns of holes.

 To flip a dimension arrow, click the **dimension**, click the **blue dot**. View the illustrated dimension arrow direction icons.

 To modify the dimension font size, click **Options, Document Properties, Annotations Display**, and check the **Always display text at the same size** box. Adjust the Font size using the **Options, Document Properties, Annotation Font** option.



Where should the PLATE-A reference planes be located?
 Answer: Review the RODLESS-CYLINDER\ MY1M2104Table part to locate the planes of symmetry.

The MY1M2104Table part identifies the overall sketch dimensions and orientation of the PLATE-A part.

The MY1M2104Table part is centered on the Front and Right Plane.

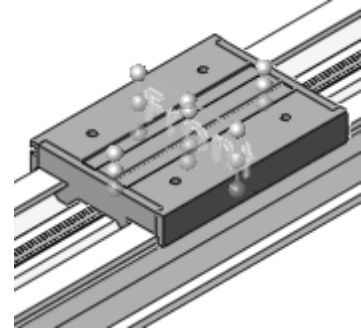

The first feature of the PLATE-A part is an Extruded Base (Boss-Extrude1) feature. The Top Plane is the Sketch plane. Center the rectangular sketch on the Front and Right Plane.

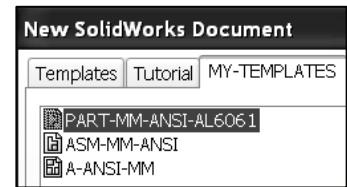

Utilize 15mm Aluminum plate stock. The PLATE-A part utilizes the custom PART-MM-ANSI-AL6061 Template created in Chapter 2.

Plan Mate types before creating the Base feature of the part. Mates create geometric relationships between assembly components. As you add mates, you define the allowable directions of linear or rotational motion of the components. You can move a component within its degrees of freedom, visualizing the assembly's behavior.

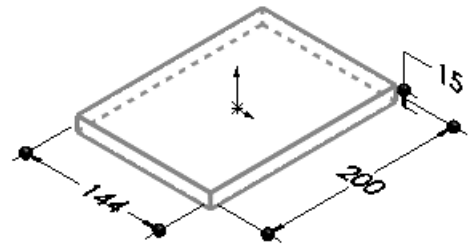

Review the Mates between the PLATE-A part and the MY1M2104Table part.

Mate Type:	PLATE-A part:	RODLESS-CYLINDER\ MY1M2104Table part:
Coincident	Bottom face	Top face
Concentric	Lower right hole	Lower right hole
Concentric	Upper left hole	Upper left hole

 Align the component in the same orientation as the assembly to avoid unnecessary use of Rotate Component in the assembly. Create the Extruded Base (Boss-Extrude1) feature vertical and horizontal dimensions in the same orientation as the MY1M2104Table Boss-Extrude1 feature.

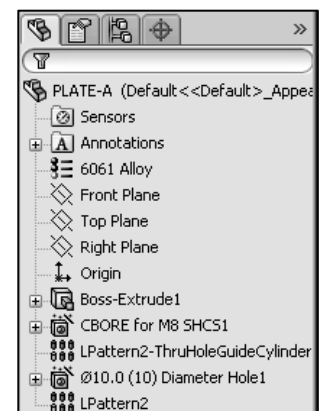

The PLATE-A part requires two sets of four holes. The first set contains four Cbores.

The second set contains four Thru Holes.

Create a 2x2 Linear Pattern for both hole types. Utilize the Hole Wizard tool.

The seed feature of the Linear Pattern is the first Cbore. The PLATE-A part positions the seed feature in its lower right corner. Utilize the seed feature and Linear Pattern tool in the assembly.

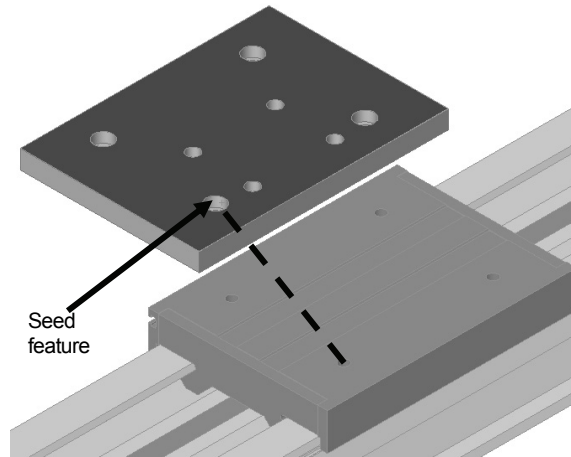

Display Cbore Holes and the Thru Holes in the ANSI Metric standard. Other standards may be selected when using the Hole Wizard or SolidWorks\Toolbox.

Prepare for future design changes. If the overall size of PLATE-A changes, the hole location remains constant. Select the Front and Right Plane for a Symmetric Reference for the Cbore.

Select the Front Plane for a Symmetric Reference for the Thru Holes.

Select the Right plane for a Coincident Reference.

Activity: Create PLATE-A In-Context of the Assembly

Display the RODLESS-CYLINDER reference planes.

28) Expand MY1M2104Table from the RODLESS-CYLINDER FeatureManager as illustrated.

29) Click **Front** Plane from the FeatureManager.

30) Hold the **Ctrl** key down.

31) Click **Right** Plane from the FeatureManager.

32) Release the **Ctrl** key.

33) Right-click **Show** from the Context toolbar. The Front and Right Planes are displayed in the Graphics window.

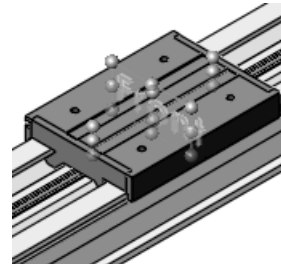
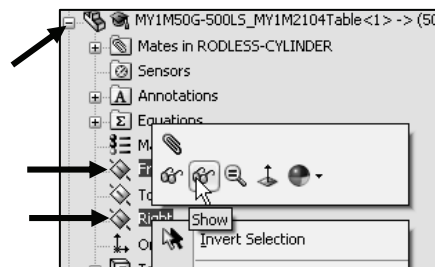

Create a New Part.

- 34) Click **New**  from the Menu bar menu.
- 35) Click the **MY-TEMPLATES** tab.
- 36) Double-click the **PART-MM-ANSI-AL6061** Part template. The Part FeatureManager is displayed.



Save the New Part.

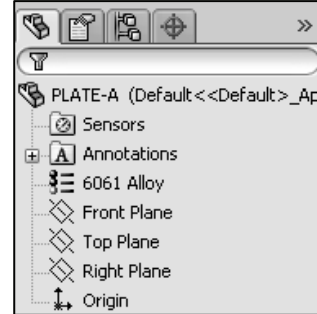

- 37) Click **Save**.
- 38) Select the **DELIVERY-STATION** folder.
- 39) Enter **PLATE-A** for File name.
- 40) Click **Save**. The PLATE-A FeatureManager is displayed.



By default, the Bill of Materials utilizes the File name field for the Part Number column and the Description field for the Description column.

 Later in this book, apply Custom Properties to control the Description and Part number.

Sketch the profile.

- 41) Right-click **Top Plane** from the FeatureManager. This is your Sketch plane for the Sketch Profile.
- 42) Click **Sketch**  from the Context toolbar. The Sketch toolbar is displayed
- 43) Click the **Center Rectangle**  tool from the Sketch toolbar. Note: The Center Rectangle tool sketches rectangles at a center point.
- 44) Click the **Origin** (the center point for your sketch).
- 45) **Sketch** a center rectangle as illustrated.

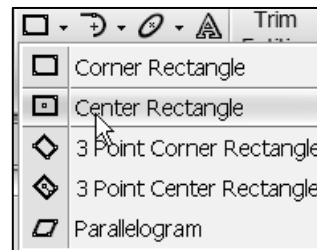
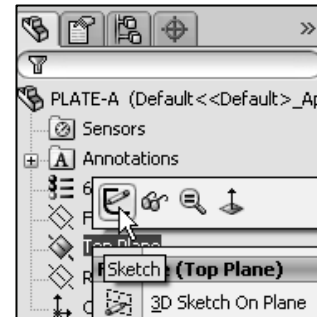

De-select the Sketch tool.

- 46) Right-click **Select** in the Graphics window to deselect the Center Rectangle Sketch tool.

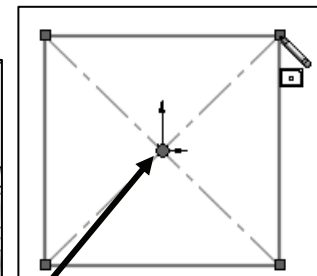
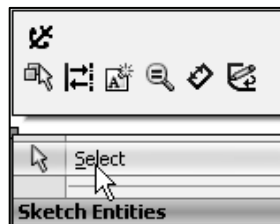

Origin

Insert an Equal relation if needed.

- 47) Insert an **Equal** relation between the top horizontal line and the bottom horizontal line.
- 48) Insert an **Equal** relation between the left vertical line and the right vertical line.

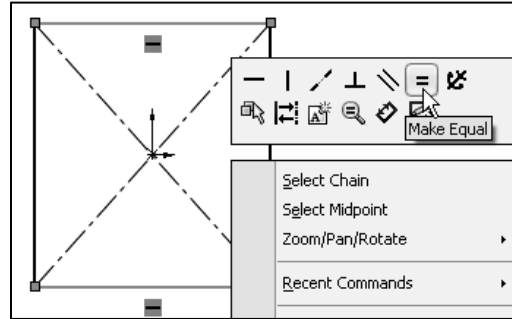

Add a vertical dimension.

- 49) Click the **Smart Dimension**  tool from the Sketch toolbar.

- 50) Click the **right vertical line**.

- 51) Click a **position** to the right of the vertical line.

- 52) Enter **200**.

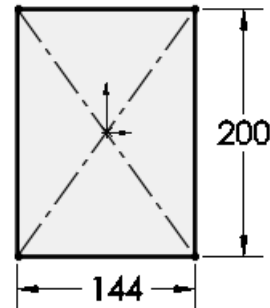

Add a horizontal dimension.

- 53) Click the **bottom horizontal line**.

- 54) Click a **position** below the horizontal line. Enter **144**.

- 55) Click **OK**  from the Dimension PropertyManager. Sketch1 is fully defined and is displayed in black.

 Use the **z** key to Zoom out, the **Z** key to Zoom in, and the **f** key to fit the model to the Graphics window.

Extrude the sketch.

- 56) Click the **Features** tab from the CommandManager.

- 57) Click the **Extruded Boss/Base**  tool from the Features toolbar. The Boss-Extrude PropertyManager is displayed.

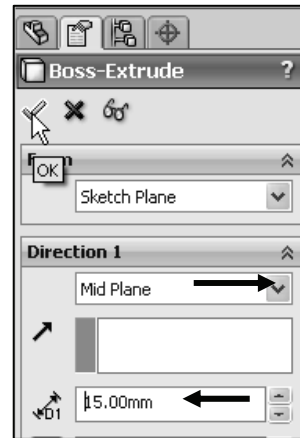

- 58) Select **Mid Plane** (Design Intent) for End Condition in Direction 1.

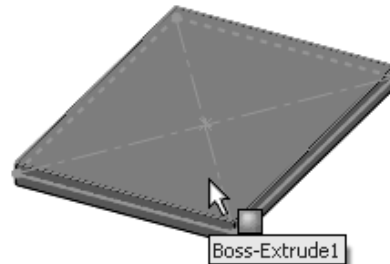

- 59) Enter **15mm** for Depth.

- 60) Click **OK**  from the Boss-Extrude PropertyManager. Boss-Extrude1 is displayed in the FeatureManager



Apply the Hole Wizard tool. Create the M8 CBORE hole.

- 61) Click the **top face** of PLATE-A in the lower right corner as illustrated. Boss-Extrude1 is highlighted in the FeatureManager.

- 62) Click the **Hole Wizard**  tool from the Features toolbar. The Hole Specification PropertyManager is displayed. The Type tab is selected by default.
- 63) Click **Counterbore** for Hole Type.
- 64) Select **Ansi Metric** for Standard.
- 65) Select **Socket Head Cap Screw** for Type.
- 66) Select **M8** for Size.
- 67) Select **Through All** for End Condition.
- 68) Click the **Positions** tab. The Point  icon is displayed.

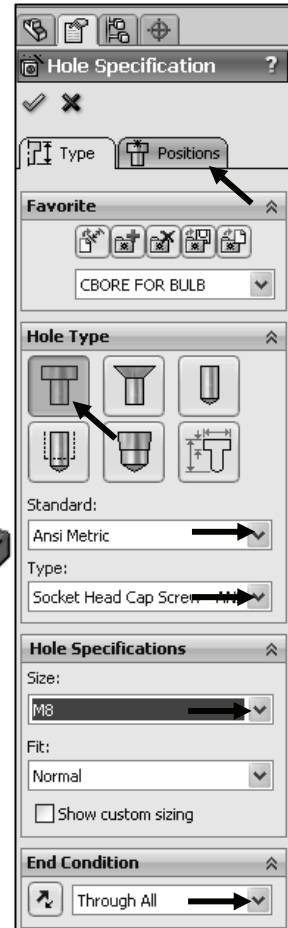
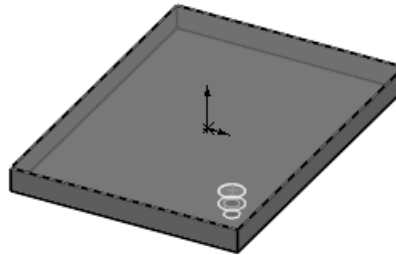

Insert dimensions.

- 69) Click the **Smart Dimensions**  tool from the Sketch toolbar.
- 70) Click the **Origin**.
- 71) Click the **Cbore center point**.
- 72) Click a **position** below the horizontal profile line.
- 73) Enter **45mm**.
- 74) Click the **Origin**.
- 75) Click the **Cbore center point**.
- 76) Click a **position** to the right of the vertical profile line.
- 77) Enter **60mm**. View the dimensions.

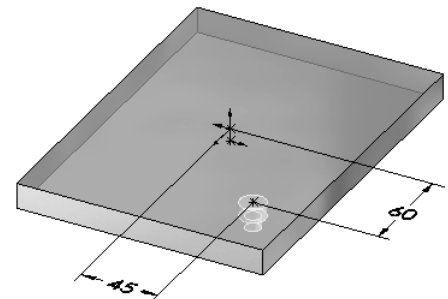
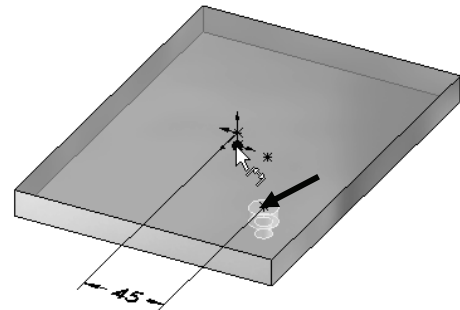

- 78) Click **OK** ✓ from the Dimension PropertyManager
- 79) Click **OK** ✓ from the Hole Position PropertyManager. CBORE for M8 SHCS1 is displayed in the FeatureManager.
- 80) Click **Hidden Lines Visible** from the Heads-Up View toolbar.

The CBORE for M8 SHCS1 is displayed in the Graphics window. CBORE for M8 SHCS1 is the seed feature for the first Linear Pattern.

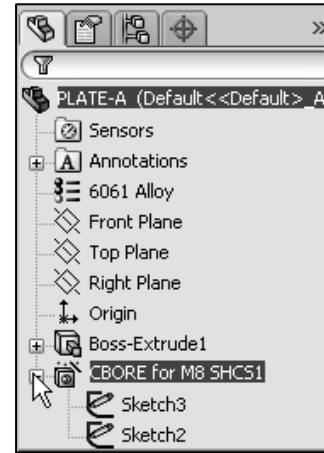

Create a Linear Pattern Feature.

- 81) Click the **Linear Pattern** tool from the Features toolbar. The Linear Pattern PropertyManager is displayed.

Display the Top view.

- 82) Click **Top** view from the Heads-up View toolbar.

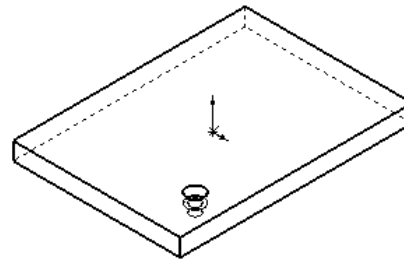

- 83) Click the **bottom edge** of PLATE-A for Direction 1.

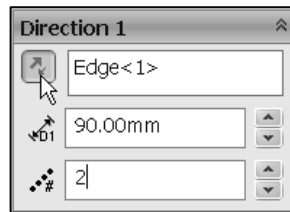

- 84) If required, click the **Reverse Direction** button. The direction arrow points to the left.

- 85) Enter **90mm** for Spacing in Direction 1.

- 86) Enter **2** for Instances.

- 87) Click the **left vertical line** for Direction 2.

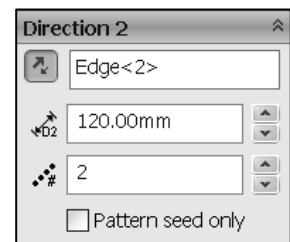

- 88) If required, click the **Reverse Direction** button. The direction arrow points upward.

- 89) Enter **120mm** for Spacing in Direction 2.

- 90) Enter **2** for Instances.

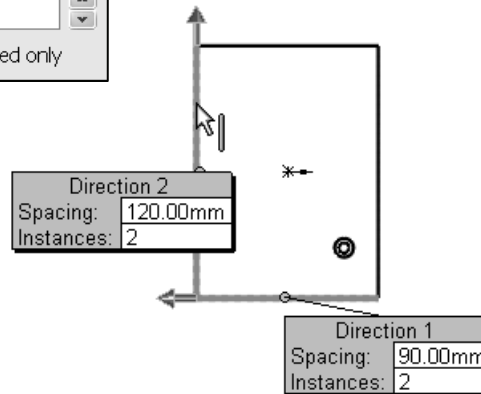
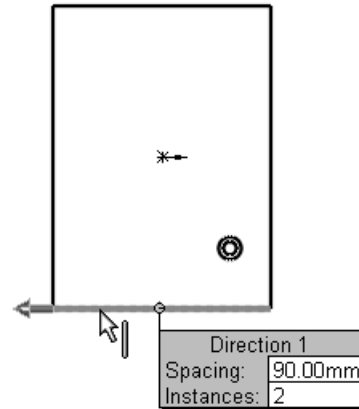

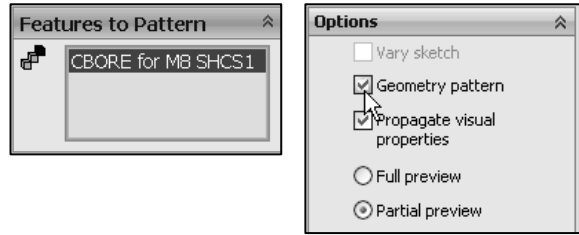

- 91) Check **Geometry pattern** from the Options box.
- 92) If required, click inside the **Features to Pattern** box. **Expand** PLATE-A in the Flyout FeatureManager. Click **CBORE for M8 SHCS1**. CBORE for M8 SHCS1 is displayed in the Features to Pattern box.

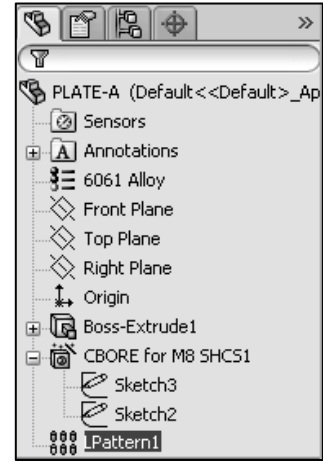
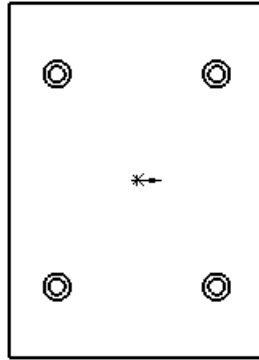

- 93) Click **OK** from the Linear Pattern PropertyManager. LPatten1 is created in the FeatureManager.

 The checked Geometry pattern option copies only the geometry (faces and edges) of the features. The unchecked Geometry pattern option results in a calculated solution for every instance in the pattern.



 The geometry pattern option usually decreases the time required to create and rebuild a pattern.

Apply the Hole Wizard tool. Create an M10 Thru Hole.

- 94) Click the **top face** of PLATE-A in the lower right hand corner. Boss-Extrude1 is highlighted in the FeatureManager.
- 95) Click the **Hole Wizard** tool from the Features toolbar. The Hole Specification PropertyManager is displayed.
- 96) Click **Hole** for Hole Type.
- 97) Select **Ansi Metric** for Standard.
- 98) Select **Drill sizes** for Type.
- 99) Select **10** for Size.
- 100) Select **Through All** for End Condition.
- 101) Click the **Positions** tab. The Point  icon is displayed.

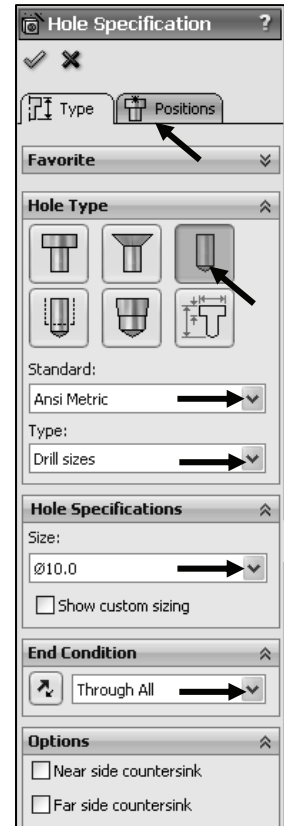
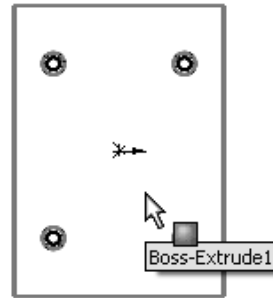

Dimension the hole.

102) Click the **Smart Dimensions**  tool from the Sketch toolbar.

103) Click the **Origin**.

104) Click the **hole center point** as illustrated.

105) Click a **position** below the horizontal profile line.

106) Enter **48mm**.

107) Click the **Origin**.

108) Click the **hole center point**.

109) Click a **position** to the right of the vertical profile line.

110) Enter **33mm**.

111) Click **OK**  from the Dimension PropertyManager.

112) Click **OK**  from the Hole Position PropertyManager. The hole is the seed feature for the second Linear Pattern.

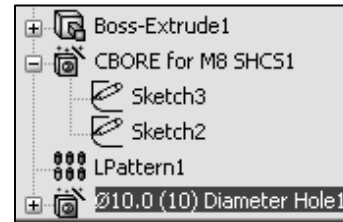
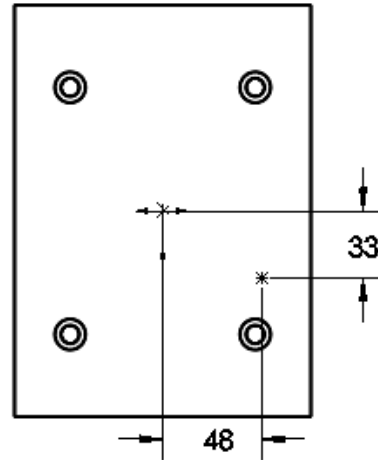

Create the second Linear Pattern.

113) Click the **Linear Pattern**  tool from the Features toolbar. The Linear Pattern PropertyManager is displayed.

114) Click the **bottom edge** for Direction1. Edge<1> is displayed. If required, click the **Reverse Direction** button. The direction arrow points to the left.

115) Enter **48mm** for Spacing in Direction 1.

116) Enter **2** for Instances.

117) Click the **left vertical edge** for Direction 2. The direction arrow points upward. If required, click the **Reverse Direction** button.

118) Enter **33*2** for Spacing in Direction 2.

119) Enter **2** for Instances.

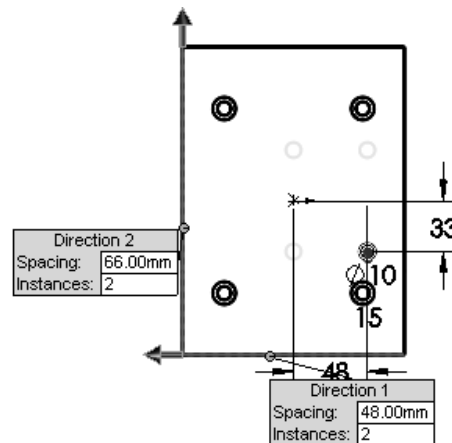

- 120) If required, click inside the **Features to Pattern** box.
- 121) **Expand** PLATE-A in the Graphics window.
- 122) Click **10.0 (10) Diameter Hole1** from the fly-out FeatureManager.
- 123) Click **OK**  from the Linear Pattern PropertyManager. LPattern2 is displayed in the FeatureManager.

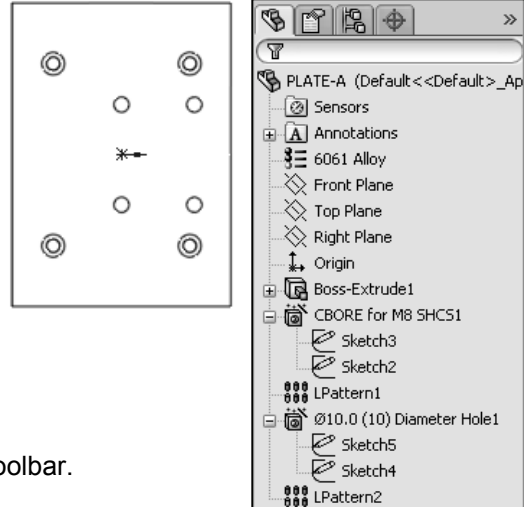

Display an Isometric view.

- 124) Click **Isometric** view from the Heads-up View toolbar.

Save the PLATE-A part.

- 125) Click **Save**.



Activity: Create a New Folder in the SolidWorks Design Library

Create a new parts folder in the SolidWorks Design Library.

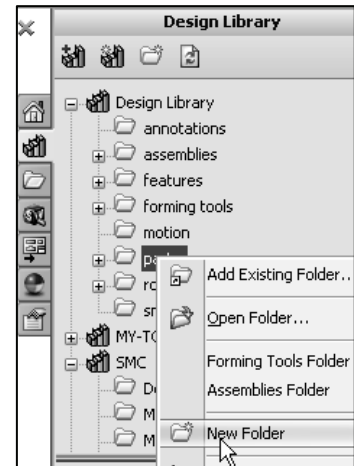
- 126) **Expand** the Design Library folder.
- 127) Click the **Push Pin**  icon to pin the Design Library open.
- 128) Right-click on **parts** in the folder area.
- 129) Click **New Folder** as illustrated.
- 130) Enter **plates** for Folder name.
- 131) Double-click the **plates** folder. The folder is empty.



Insert PLATE-A into the plates file folder.

- 132) Drag the **PLATE-A**  PLATE-A part icon from the top of the FeatureManager into the plates folder. The Add to Library PropertyManager is displayed.
- 133) Click **OK**  from the Add to Library PropertyManager. PLATE-A is contained in the parts/plates folder.

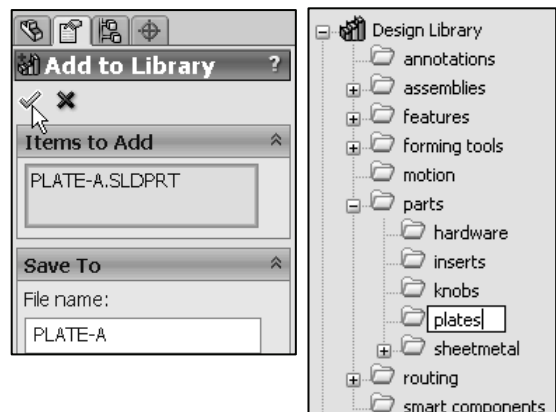

 Utilize **Options, File Locations, Design Library** to insert additional folders into the Design Library.

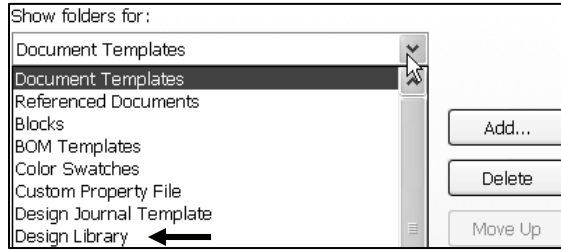

Assembly Mating Techniques

The action of assembling components in SolidWorks is defined as Mates. Mates simulate the construction of the assembly in a manufacturing environment. In dynamics, components possess linear motion along the x, y, and z-axes and rotational motion around the x, y, and z-axes. In an assembly, each component contains six degrees of freedom: three translational (linear) and three rotational. All components behave as rigid bodies. Components do not flex or deform.

In a static analysis, there is no motion. How do static and dynamic principles translate to component Mates? Answer: Mates remove degrees of freedom.

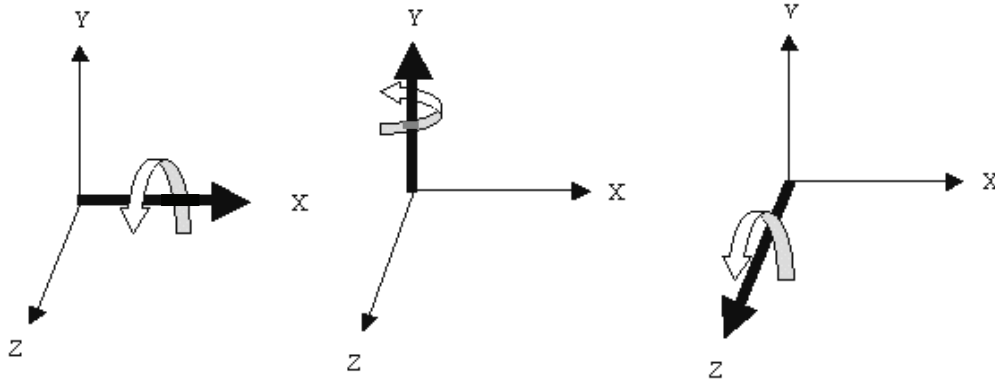

 Understand the engineering mechanics of the component before creating Mates.

Example 1:

Static: Fasten the DELIVERY-STATION assembly to the MOUNTING-PLATE part. The MOUNTING PLATE part is fixed to the Origin of the final assembly. The MOUNTING-PLATE part does not translate or rotate.

Example 2:

Dynamic: Assemble the PLATE-A part to the RODLESS-CYLINDER\ MY1M2104Table part. The MY1M2104Table part slides along the MY1M2104Tubes part. The PLATE-A part travels at the same velocity as the MY1M2104Table part. Insert the Mates between the PLATE-A part and the MY1M2104Table part.

Assembly modeling requires practice and time. Below are a few helpful techniques to address component mating. Utilize these techniques throughout the development of the 3AXIS-TRANSFER assembly and sub-assemblies.

Mating Techniques:
Right-click in the assembly Graphics window to avoid mouse pointer “movement” to the assembly toolbar and the assembly FeatureManager.
Use the Zoom and Rotate tools to select the geometry in the mate process. Zoom in to the correct face. Right-click Select Other for hidden geometry.
Use View Orientation, Named Views to display a key area of the model.
Apply various colors to features and components to improve display.
Utilize Reference Planes and axes to assemble complex geometry.
Activate Temporary axes and Show Planes when required for Mates, otherwise Hide All Types from the View menu. Create Shortcut keys to activate View commands.
Select Reference Planes from the FeatureManager for complex components. Expand the FeatureManager to view the correct plane.
Remove display complexity. Hide components when visibility is not required.
Suppress components when Mates are not required. Group fasteners at the bottom of the FeatureManager. Suppress fasteners and their assembly patterns to save rebuild time and file size. Utilize caution with suppressed components. Suppressed Mates may cause related components to translate and rotate. Use View Mates to understand mating dependencies.
Utilize Section views to select internal geometry. Utilize Transparency to see through components required for mating.
Use the Move Component and Rotate Component commands before Mating. Position the component in the correct orientation.
Use a Coincident Mate when the distance value between two entities is zero. Utilize a Distance Mate when the distance value between two entities is not zero.
Cylindrical components require a Concentric and Coincident Mate. They are not fully defined.

Verify the position of the components. Use Top, Front, Right and Section views.
Rename Mates, key features and Reference Geometry with descriptive names.
Avoid unwanted references. Confirm the geometry name you selected in the Mate Property Manager.
Uncheck the Show preview option to prevent components from moving out of the Graphics window during mating.

LINEAR-TRANSFER Assembly

The RODLESS-CYLINDER assembly is the Base (first) component in the LINEAR-TRANSFER assembly.

All components of the RODLESS-CYLINDER assembly remain stationary, except for the MY1M2104Table part.

The MY1M2104Table part linearly translates along the MY1M2104Tubes part.

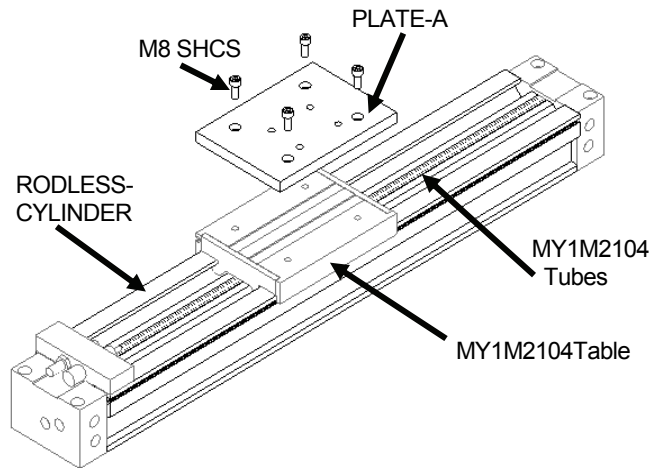

LINEAR-TRANSFER assembly

Perform the following tasks to complete the LINEAR-TRANSFER assembly.

- Create the LINEAR-TRANSFER assembly.
- Fix the RODLESS-CYLINDER assembly to the Origin of the LINEAR-TRANSFER assembly.
- Assemble the PLATE-A part to the RODLESS-CYLINDER\MY1M2104Table part.
- Determine the diameter and length of the SHCS using the Measure tool. Mate the SHCS with the SolidWorks\Toolbox.

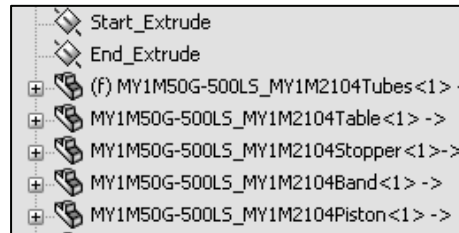

 The PLATE-A part and RODLESS-CYLINDER assembly are active documents.

Activity: Insert Multiple Components in an Assembly

Create the LINEAR-TRANSFER assembly.

134) Click **Make Assembly from Part/Assembly**  from the Menu bar toolbar.

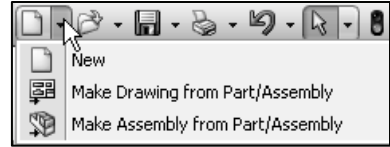

135) Click the **MY-TEMPLATES** tab.

136) Double-click **ASM-MM-ANSI**. Note: This Assembly Template was created in Chapter 2



The Begin Assembly PropertyManager is displayed. In order to select multiple components from the Part/Assembly to Insert, box, select the Push Pin as illustrated. The Begin Assembly PropertyManager remains open. Utilize the Browse button to select components not displayed in the Open documents box.

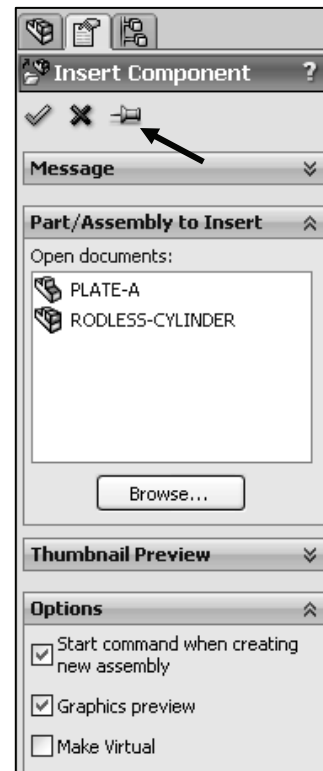

Inset the ROD-CYLINDER assembly.

137) Click the **Push Pin** icon from the Begin Assembly PropertyManager.

138) Click **RODLESS-CYLINDER** from the Open documents box.

139) Click **inside** the Graphics window. The first inserted component is fixed to the Origin.

140) Click **PLATE-A** in the Open documents dialog box.

141) Click a **position** above the RODLESS-CYLINDER as illustrated.

142) Click **OK**  from the Insert Begin Assembly PropertyManager. View the results in the Graphics window.

Hide the Origins.

143) Click **View**; uncheck **Origins** from the Menu bar menu.

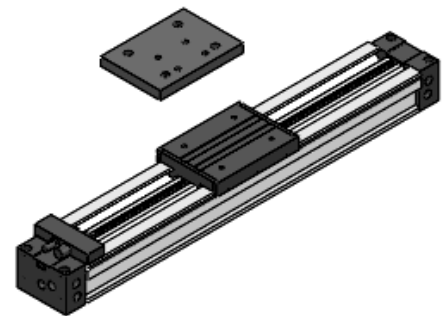

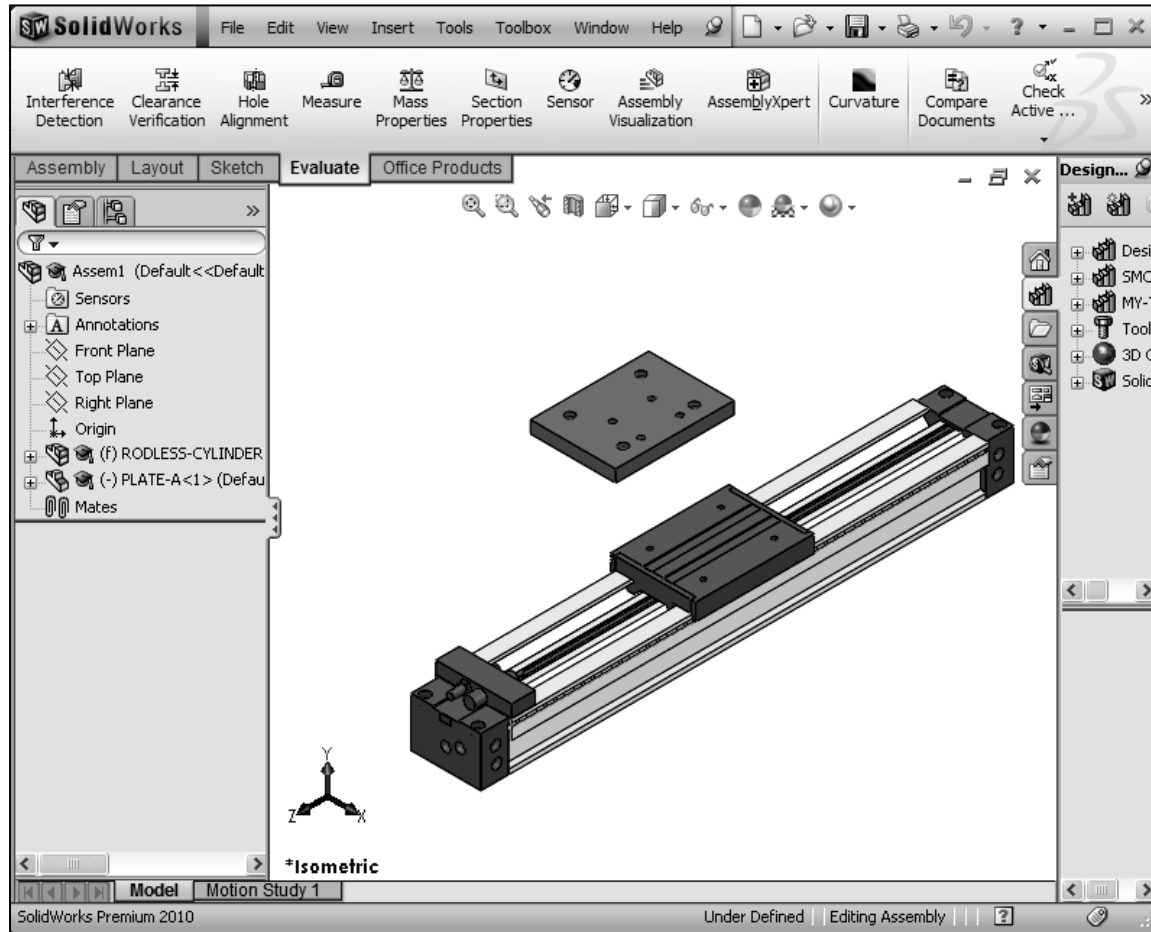

Save the assembly.

144) Click **Save**.

145) Select the **DELIVERY-STATION** for Save in folder.

146) Enter **LINEAR-TRANSFER** for File name.

147) Click **Save**. The LINEAR-TRANSFER assembly FeatureManager is displayed.



Right-click the assembly name in the FeatureManager and click Set Lightweight to Resolved to fully resolve the Assembly.

Customize the Keyboard

Customize your keyboard to create Shortcut keys for reference geometry. Create Shortcut keys to check or uncheck Hide All Types, Planes, Axes, Temporary Axes and Origins. Large Assembly Mode hides all Reference geometry by default.

Create a new view in the View Orientation dialog box. An enlarged view saves time in assembling the MY1M2104Table holes to the PLATE-A holes.

Activity: Customize the Keyboard

Create four View Shortcut keys.

148) Click **Tools, Customize** from the Menu bar menu.

149) Click the **Keyboard** tab.

150) Click **View** from the Categories box.

Create the Planes Shortcut key.

151) Select **Planes** from the Commands box.

152) Enter **Shift + P** in the Press new Shortcut key.

Create the Axes Shortcut key.

153) Select **Axes** from the Commands box.

154) Enter **Shift + A** in the Press new Shortcut key.

Create the Temporary Axes Shortcut key.

155) Select **Temporary Axes** from the Commands list box.

156) Enter **Shift + T** in the Press new Shortcut key.

Create the Origins Shortcut key.

157) Select **Origins** from the Commands list box.

158) Enter **Shift + O** in the Press new Shortcut key.

159) Click **OK** from the Customize dialog box.

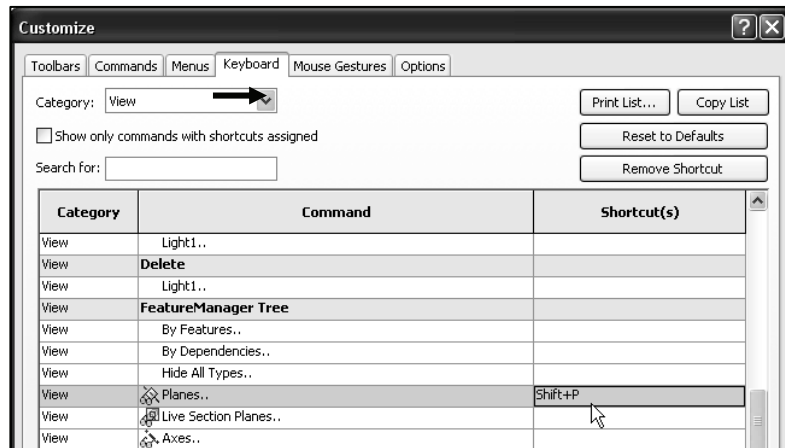

Activity: Create a New View

Create a New View.

160) Zoom in on the MY1M2104Table.

161) Rotate the MY1M2104Table as illustrated.

162) Press the Space Bar to display the View Orientation dialog box.

163) Click Pin  from the Orientation box.

164) Click New View .

165) Enter table-view for view name.

166) Click OK from the Named View box.

167) Uncheck Pin from the Orientation box.

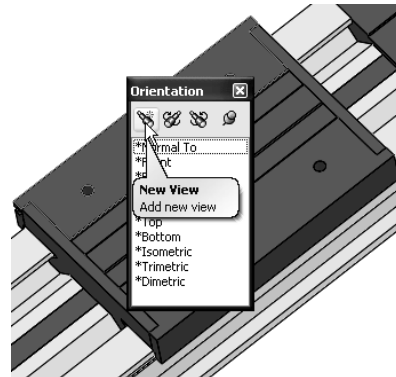



Display an Isometric view.

168) Click Isometric view from the Heads-up View toolbar.

Display the table-view.

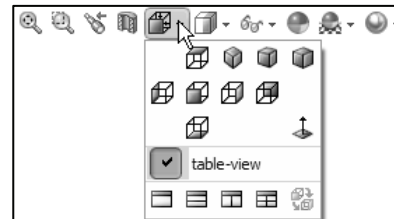
169) Click table-view from the Heads-up View toolbar.



 Note: Custom Shortcut keys are set on the current keyboard. To save/restore settings to another computer, utilize the Start, All Programs, SolidWorks, SolidWorks Tools, Copy Settings Wizard. For best practice, System Administrators copy settings to network computers and roaming user profiles.

Modify the Base Component: Fixed / Float options

By default, the first component in an assembly is fixed with respect to the assembly Origin. Click OK from the Begin Assembly PropertyManager to fixed the first component to the Origin. The component receives an (f) in the FeatureManager.

 The Float state displays a minus (-) in the FeatureManager.

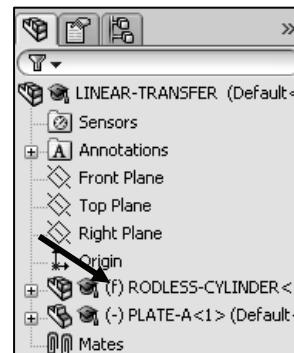

As components increase in complexity, visualizing the icon becomes more challenging. In many design situations, the first component orientation and position with respect to the assembly Origin requires modification.

How do you address these issues? Answer: Modify the Fixed state to a Float state.

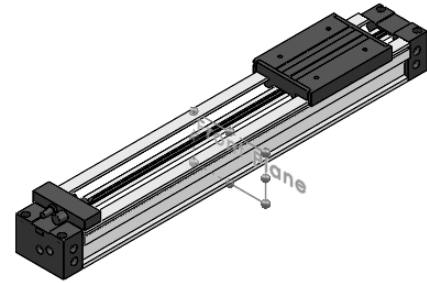

The Float state displays a minus (-) in the FeatureManager. Move and rotate the component with respect to the assembly Origin.

Mate the first component to reference assembly geometry.

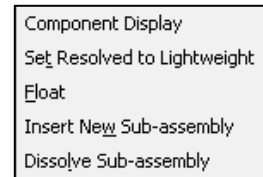

Mate PropertyManager

Mates provide the ability to create geometric relationships between assembly components. Mates define the allowable directions of rotational or linear motion of the components in the assembly. Move a component within its degrees of freedom in the Graphics window, to view the behavior of an assembly.

Mates are solved together as a system. The order in which you add mates does not matter. All mates are solved at the same time. You can suppress mates just as you can suppress features.

The Mate PropertyManager provides the ability to select either the Mates or Analysis tab. Each tab has a separate menu. The Analysis tab requires the ability to run Simulation Motion. The Analysis tab will not be covered in detail. The Mate PropertyManager displays the appropriate selections based on the type of geometry you select.

Mate PropertyManager: Mates tab

The Mates tab is the default tab. The Mates tab provides the ability to insert a Standard, Advanced, or Mechanical Mate.

- **Mate Selections.** The Mate Selections box provides the following selections:
 - **Entities to Mate.** Displays the selected faces, edges, planes, etc. that you want to mate.

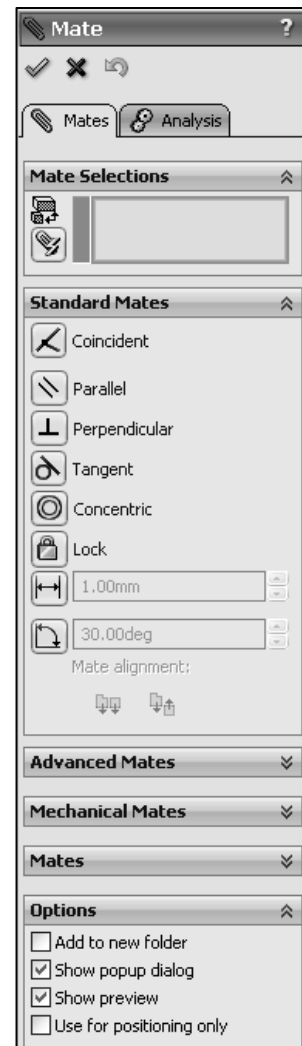

- **Multiple mate mode.** Mates multiple components to a common reference in a single operation. When activated, the following selections are available:
- **Common references.** Displays the selected entity to which you want to mate several other components.
- **Component references.** Displays the selected entities on two or more other components to mate to the common reference. A mate is added for each component.
- **Create multi-mate folder.** Groups the resulting mates in a Multi-Mates folder.
- **Link dimensions.** Only available for Distance and Angle mates in a multi-mate folder. Provides the ability to link dimensions. The variable name in the Shared Values dialog box is the same as the multi-mate folder name.

- **Standard Mates.** The Standard Mates box provides the following selection:

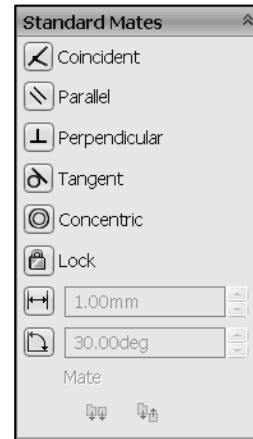

- **Coincident.** Locates the selected faces, edges, or planes so they use the same infinite line. A Coincident mate positions two vertices for contact.
- **Parallel.** Locates the selected items to lie in the same direction and to remain a constant distance apart.
- **Perpendicular.** Locates the selected items at a 90 degree angle to each other.
- **Tangent.** Locates the selected items in a tangent mate. At least one selected item must be either a conical, cylindrical, spherical face.
- **Concentric.** Locates the selected items so they can share the same center point.
- **Lock.** Maintains the position and orientation between two components.
- **Distance.** Locates the selected items with a specified distance between them. Use the drop-down arrow box or enter the distance value directly.
- **Angle.** Locates the selected items at the specified angle to each other. Use the drop-down arrow box or enter the angle value directly.



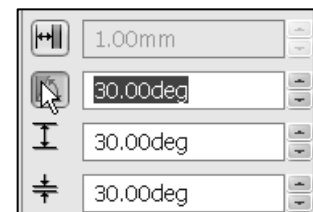
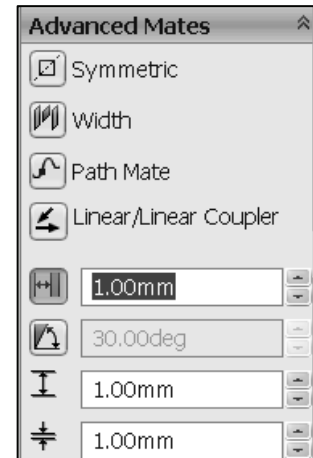

- **Mate alignment.** Provides the ability to toggle the mate alignment as necessary. There are two options. They are:
 - **Aligned.** Locates the components so the normal or axis vectors for the selected faces point in the same direction.
 - **Anti-Aligned.** Locates the components so the normal or axis vectors for the selected faces point in the opposite direction.

- **Advanced Mates.** The Advanced Mates box provides the following selections:
 - **Symmetric.** Forces two similar entities to be symmetric about a planar face or plane.
 - **Width.** Centers a tab within the width of a groove.
 - **Path Mate.** Constrains a selected point on a component to a path.
 - **Linear/Linear Coupler.** Establishes a relationship between the translation of one component and the translation of another component.
 - **Limit.** Provides the ability to allow components to move within a range of values for distance and angle. Select the angle and distance from the provided boxes. Specify a starting distance or angle as well as a maximum and minimum value.
 - **Distance.** Locates the selected items with a specified distance between them. Use the drop-down arrow box or enter the distance value directly.
 - **Angle.** Locates the selected items at the specified angle to each other. Use the drop-down arrow box or enter the angle value directly.
 - **Mate alignment.** Provides the ability to toggle the mate alignment as necessary. There are two options. They are:
 - **Aligned.** Locates the components so the normal or axis vectors for the selected faces point in the same direction.
 - **Anti-Aligned:** Locates the components so the normal or axis vectors for the selected faces point in the opposite direction.

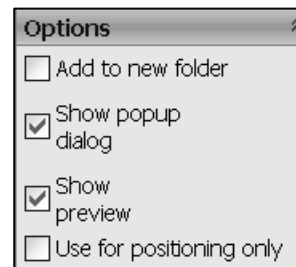
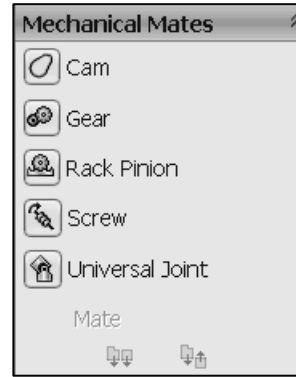

- **Mechanical Mates.** The Mechanical Mates box provides the following selections:
 - **Cam.** Forces a plane, cylinder, or point to be tangent or coincident to a series of tangent extruded faces.
 - **Gear.** Forces two components to rotate relative to one another around selected axes.
 - **Rack and Pinion.** Provides the ability to have Linear translation of a part, rack causes circular rotation in another part, pinion, and vice versa.
 - **Screw.** Constrains two components to be concentric, and also adds a pitch relationship between the rotation of one component and the translation of the other.
 - **Universal Joint.** The rotation of one component (the output shaft) about its axis is driven by the rotation of another component (the input shaft) about its axis.
- **Mates.** The Mates box displays the activated selected mates.
- **Options.** The Options box provides the following selections:
 - **Add to new folder.** Provides the ability for new mates to be added and to be displayed in the Mates folder in the FeatureManager design tree.
 - **Show popup dialog.** Selected by default. Displays a standard mate, when added in the Mate pop-up toolbar. When cleared, adds the standard mates in the PropertyManager.
 - **Show preview.** Selected by default. Displays a preview of a mate when enough selections for a valid mate occur.
 - **Use for positioning only.** When selected, components move to the position defined by the mate. A mate is not added to the FeatureManager design tree. A mate is displayed in the Mates box. Edit the mate in the Mate box. The mate is not displayed in the FeatureManager design tree.



 The Use for positioning only box is an alternative to adding numerous mates, then afterward deleting those mates in the FeatureManager design tree.

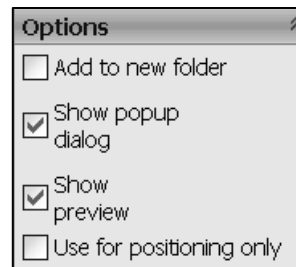

Mate PropertyManager: Analysis tab

You can assign mate properties for use in Simulation Motion analysis.

 You can add the properties without having Simulation Motion added in.

The Analysis tab provides the following options for a selected mate:

- **Load Bearing Faces.** Associates additional faces with the selected mate to define which faces share in bearing the load. This option is not available for **Symmetric**, **Width**, **Path**, or **Cam** mates.
 - **Isolate components.** Provides the ability to only display the components referenced by the mate.
 - **Friction.** Provides the ability to associate friction properties with some types of mates. The following options are available:
 - **Parameters.** Select how to define the friction properties of the mate.
 - **Specify materials.** Select the materials of the components from the first and second lists.
 - **Specify coefficient.** Provides the ability to specify the following:
 - **Dynamic Friction Coefficient** by typing a number or moving the slider between:
 - **Slippery** and **Sticky**.

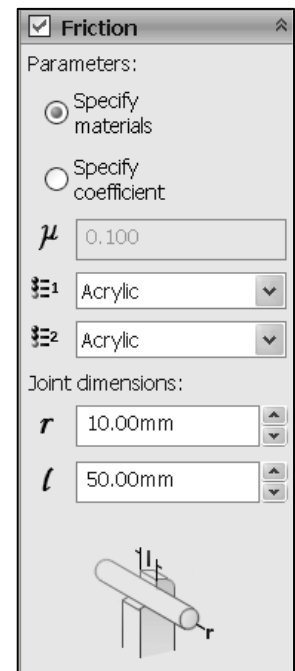
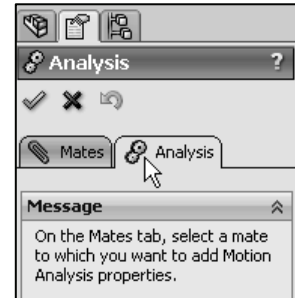

- **Joint dimensions.** Available dimensions vary depending on geometry and mate type. They are:

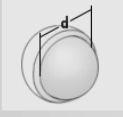
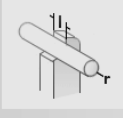
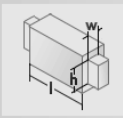
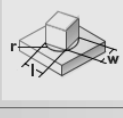
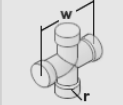
Geometry	Dimensions	Mate Types
Spherical		<ul style="list-style-type: none"> • Coincident mate between any two vertices, sketch points, or reference points • Concentric mate between two spherical faces
Cylindrical		<ul style="list-style-type: none"> • Concentric mate between two cylindrical faces • Coincident mate between two linear entities (edges, axes, temporary axes, sketch lines)
Translational		Coincident mate between two planar faces
Planar		Coincident mate between two planar faces
Universal Joint		Universal Joint mate

- **Bushing.** Provides the ability to associate bushing properties with a mate. Bushing properties make a mate somewhat flexible by giving it spring and damper characteristics. Mates with bushing properties can produce a more realistic distribution of forces in Simulation Motion analyses.

 See SolidWorks help for additional information.

 SolidWorks Help Topics list the rules governing Mate Type valid geometry. The valid geometry selection between components in a Coincident Mate is displayed in the Coincident Mate Table.

Mates reflect the physical behavior of a component in an assembly. In this chapter, the two most common Mate types are Concentric and Coincident.

Mates reflect the physical behavior of a component in an assembly. In this chapter, the two most common Mate Types are Concentric and Coincident.

Utilize two Concentric Mates between the two sets of holes from the PLATE-A part and the RODLESS-CYLINDER assembly.

Utilize one Coincident Mate between the two planar faces from the PLATE-A part and the RODLESS-CYLINDER assembly.

The two Concentric Mates and the one Coincident Mate remove all six degrees of freedom for the PLATE-A part.

The PLATE-A part is fully defined in the LINEAR-TRANSFER assembly.

Concentric Mate - 2 Conical faces Concentric Mate – 2 Conical faces

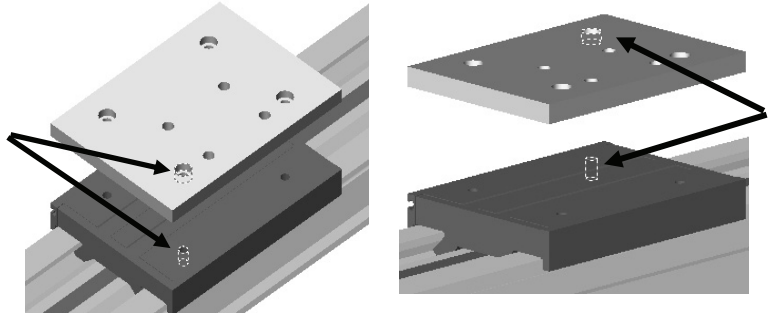

Coincident Mate – 2 Planar faces

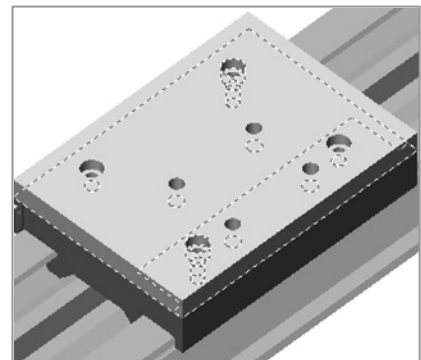
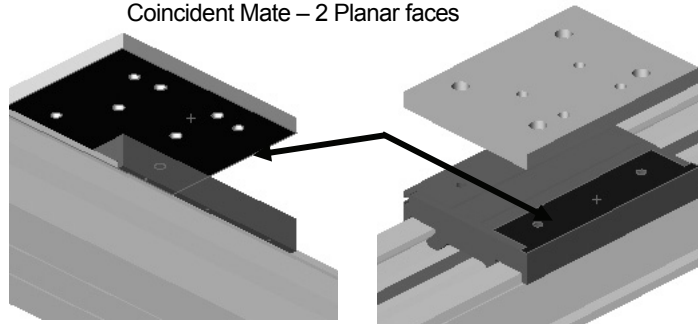

The Mates entry in the FeatureManager displays the Mates types.

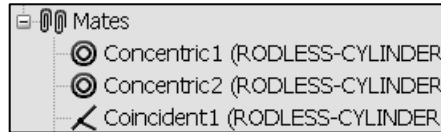

 Organize your Mates in the FeatureManager. A Mates list for a 100 component assembly has 200 - 300 Mate Types. Group Mates from the same component. Utilize folders to organize Mates. Select the free component entity to assemble and then select the target assembly entity.

SmartMates:

The SmartMates tool saves time by allowing you to create commonly used mates without using the Mate PropertyManager. A SmartMate is a Mate that automatically occurs when a component is placed into an assembly.





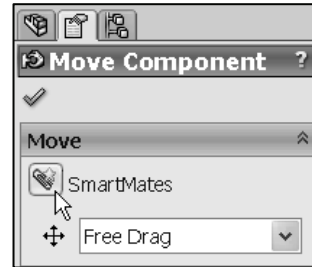

Types of SmartMates

There are various SmartMates types that are available to you in SolidWorks. The available SmartMates types are depended on the application and your situation. In most cases, the application creates a single mate. The type of SmartMate created depends on the geometry that is selected, “to drag” and the type of geometry which you drop the component.



Use one of the following entities to drag the component: a linear or circular edge, a temporary axis, a vertex, a planar face, or a cylindrical/conical face. The following types of automatic SmartMates are supported and are displayed on your mouse pointer. They are:

- *Coincident SmartMate.*

- Mate two linear edges  .
- Mate two planar faces  .
- Mate two vertices  .
- Mate two axes, two conical faces, or a single conical face and a single axis  .

- *Concentric / Coincident SmartMate.*
 - Mate two circular edges, (Peg-in-Hole SmartMate). The edges do not have to be complete circles . There are a few conditions that you need to know to apply the Peg-in-Hole SmartMate. They are:
 - One feature must be a Base or Boss.
 - The other feature must be a Hole or a Cut.
 - The features must be Extruded or Revolved.
 - The faces that are selected in the mate must both be of the same type, either a cylinder or a cone or a cylinder. Both need to be the same. You can't have one of each type.

Review the following table on three options to create a SmartMate.

Methods to Invoke Smart Mates:	
<i>Option 1: Within the assembly</i>	Hold the Alt key down. Click the mating entity of the free component. Drag the component to the assembly reference. Release the Alt key.
<i>Option 2: Within the assembly</i>	Click the Move Component tool. Click SmartMates from the Move Component PropertyManager. Option A: Double-click and drag the mating entity of the free component to the target mating entity of the assembly. Release the left mouse button. Option B: Double-click the mating entity of the free component. Single click on the target mating entity of the assembly.
<i>Option 3: From an open document</i>	Tile Horizontally with the free component and the target assembly. Select a face, edge or vertex on the free component. Drag to the target mating entity of the assembly in the second window.

 Press the Tab key after the Concentric/Coincident icon is displayed to control the Aligned or Anti-Aligned option.



Tab key Aligned/
Anti-Aligned

InPlace Mates

Components added In-Context of the assembly automatically receives an InPlace Mate within the Mates entry in the FeatureManager. The InPlace Mate is a Coincident Mate created between the Front Plane of a new component and the selected planar geometry of the assembly.

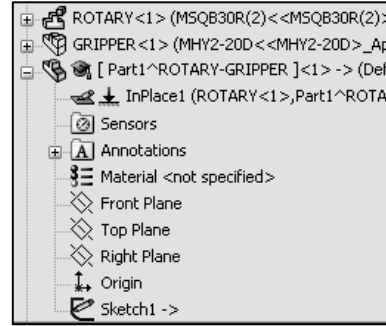

The component is fully defined by the InPlace Mate. No additional Mates are required to position the component. The InPlace1 Mate is added to the FeatureManager.

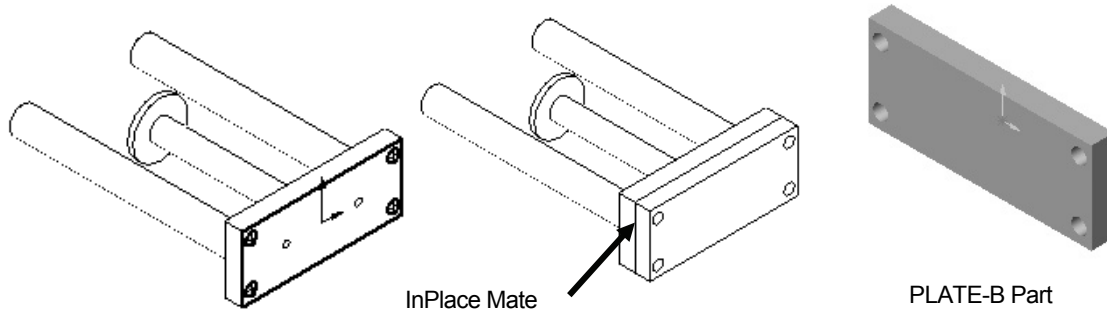

The PLATE-B part is created In-Context of the GUIDE-CYLINDER assembly.

The InPlace Mate is created between the PLATE-B Part Front Plane and the GUIDE-CYLINDER assembly right face.

InPlace Mates are explored later in this book. The next activity utilizes SmartMate Geometry based techniques to assemble the PLATE-A part to the MY1M2104Table part.

Utilize SmartMates with the Alt key to create two Concentric Mates. Utilize the SmartMates tool in the Move Component PropertyManager to create a single Coincident Mate. The SmartMate icon indicates the SmartMate mode. Practice the different methods and options.

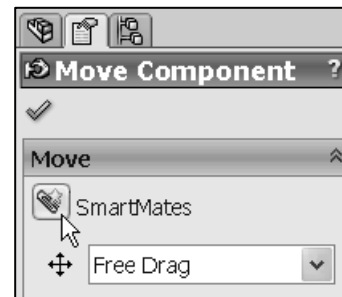

Move Component

The Move Component  tool provides the ability to drag and move a component in the Graphics window. The component moves within its degrees of freedom.

The Move Component tool uses the Move Component PropertyManager. The Move Component PropertyManager provides the following capabilities: *Move a component, Add SmartMates while moving a component, Rotate a component, Detect collision with other components, Activate Physical Dynamics and Dynamically detect the clearance between selected components.*

The available selections are dependent on the selected options. The Move Component PropertyManager provides the following selections:

- **Move.** The Move box provides the ability to move the selected component with the following options:
 - **SmartMates.** Creates a SmartMate while moving a component. The SmartMates PropertyManager is displayed.
 - **Move.** The Move box provides the following options: *Free Drag, Along Assembly XYZ, Along Entity, By Delta XYZ, and To XYZ Position.*
- **Rotate.** Provides the ability to rotate a component in the Graphics window. The Rotate box provides the following selections:
 - **Free Drag.** Provides the ability to drag a selected component in any direction.

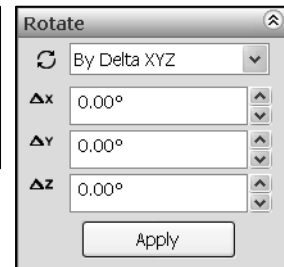
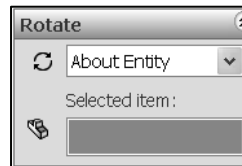
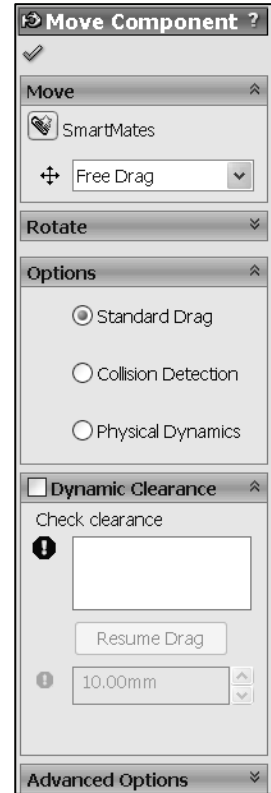

- **About Entity.** Select a line, an edge, or an axis. Drag a component from the Graphics window around the selected entity.
- **By Delta XYZ.** Moves a component around an assembly axes by a specified angular value. Enter an X, Y, or Z value in the Move Component PropertyManager. Click Apply.
- **Options.** The Options box provides the followings selections:
 - **Standard Drag.** Provides a standard drag to the mouse pointer.
 - **Collision Detection.** Detects collisions with other components when moving or rotating a component. Locate collisions for either the selected components or for all of the components that move as a result of mates to the selected components.
 - **Physical Dynamics.** View the motion of the assembly components. Drag a component. The component applies a force to components that it touches.
- **Dynamic Clearance.** The Dynamic Clearance box provides the following selections:
 - **Components for Collision Check.** Displays the dimension indicating the minimum distance between the selected components when moving or rotation a component in the Graphics window.
 - **Clearance.** Specify a distance between two components when moving or rotating.
- **Advanced Option.** The Advance Option box provides the following selections:
 - **Highlight faces.** Selected by default. Faces in the Graphics window are highlighted.
 - **Sound.** Selected by default. The computer beeps when the minimum distance in the Clearance box is reached.
 - **Ignore complex surfaces.** Clearances are only detected on the following surface types: planar, cylindrical, conical, spherical, and torodial.
 - **This configuration.** Apply the movement of the components to only the active configuration.



 The “This configuration” check box does not apply to Collision Detection, Physical Dynamics, or Dynamic Clearance. It applies only to Move Component or Rotate Component.

Rotate Component

The Rotate Component  tool provides the ability to rotate a component within the degrees of freedom defined by its mates. The Rotate Component tool uses the Rotate Component

PropertyManager. The Rotate Component PropertyManager provides the same selections as the Move PropertyManager. View the Move Component tool section for detail PropertyManager information.

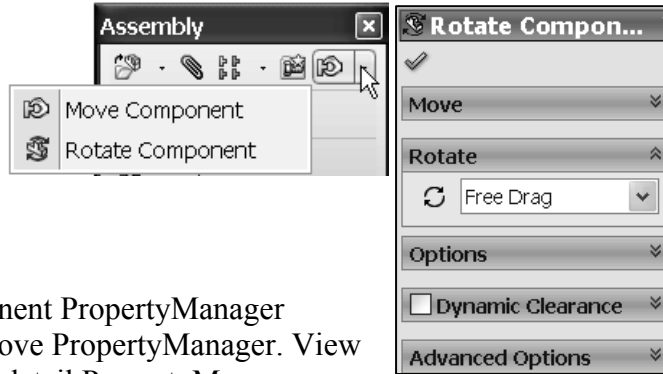

Show Hidden Components

The Show Hidden Components  tool provides the ability to toggle the display of hidden and shown components in an assembly. The tool provides the ability to select which hidden component to be displayed in the Graphics window.



Assembly Features

The Assembly Features  tool provides the ability to access the following tools for an assembly: *Hole Series*, *Hole Wizard*, *Simple Hole*, *Extruded Cut*, *Revolved Cut*, *Belt/Chain*, *Weld Symbol*.



Mate Reference

Mate references specify one or more entities of a component to use for automatic mating. When you click and drag a component with a mate reference into an assembly, the software tries to locate other combinations of the same mate reference name and type. If the name is the same, but the type does not match, the software does not add the mate.

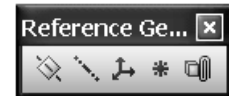

The Mate Reference  tool is located in the Reference Geometry toolbar and in the Assembly toolbar. Below are a few items to be aware of when using the Mate Reference tool:

- *Components*. You can add mate references to parts and assemblies. Select assembly geometry, example: a plane in the assembly or component geometry, example: the face of a component.

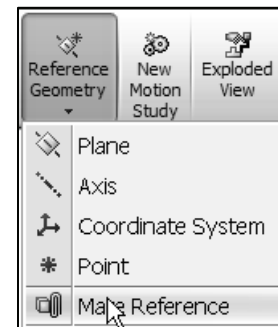

- *Multiple mate references.* More than a single mate reference can be contained in a component. All mate references are located in the Mate References folder in the FeatureManager design tree. Example: You have a component in an assembly with two mate references: nut and bolt. When you click and drag a fastener with a mate reference named nut into your assembly, mates are inserted between the entities with the same mate reference name.
- *Multiple mated entities.* Each mate reference may contain one to three mated entities. The mated entities are: a primary for the first, a secondary for the second, and tertiary for the three reference entity. Each of the entities can have an assigned mate type and alignment. For two components to mate automatically, their mate references must have the same: *Number of entities, Name, and Mate type for corresponding entities.*
- *SmartMates.* When the SmartMate PropertyManager is active, the software adds mates through the Mate References tool before it adds geometric SmartMates.

The Mate Reference  tool uses the Mate Reference PropertyManager. The Mate Reference PropertyManager provides the following selections:



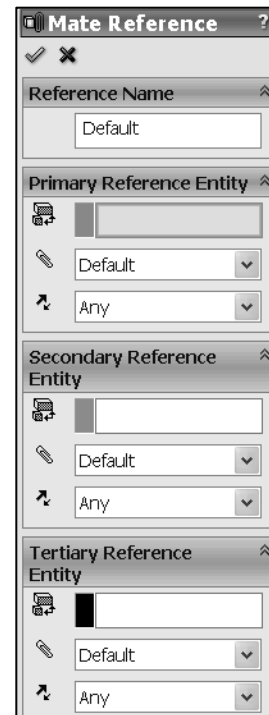

- **Reference Name.** Displays the name for the mate reference. Default is the default name reference. Accept Default or type a name in the mate reference box.
- **Primary Reference Entity.** Displays the selected face, edge, vertex, or plane for the Primary reference entity. The selected entity is used for potential mates when dragging a component into an assembly.
 - **Mate Reference Type.** Provides the ability to select the following mate types: *Default, Tangent, Coincident, Concentric, or Parallel.*
 - **Mate Reference Alignment.** Provides the ability to define the default mate for the reference entity. The following Alignment options are available: *Any, Aligned, Anti-Aligned, and Closest.*





 Secondary and tertiary entities options are the same as the Primary Reference Entity box.

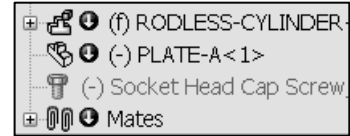

Mate Errors

The following error and warning icons in the FeatureManager design tree indicate a Mate error and type:

- : When displayed on the Mates folder , it indicates that one or more mates are not satisfied.
- : When displayed on the Mates folder , it indicates that all the mates are satisfied, but one or more mates are over defined.



Expand the Mates folder  to view each mate error icon and the mate status:

- No icon: Satisfied. Mate entities exist and a valid mate is possible.
- : Not satisfied. A valid mate is not possible for geometric reasons, or mate entities do not exist, which results in dangling mates.
- : Satisfied, but over defines the assembly.

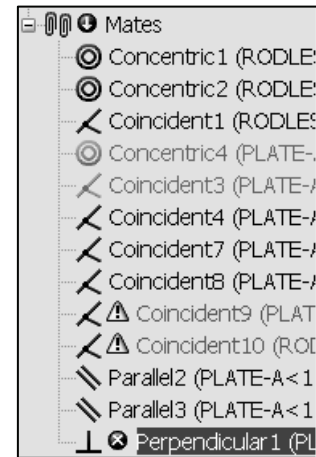

MateXpert

MateXpert is a tool that provides the ability to identify mating problems in an assembly. You can examine the details of mates that are not satisfied, and identify groups of mates which over define the assembly.

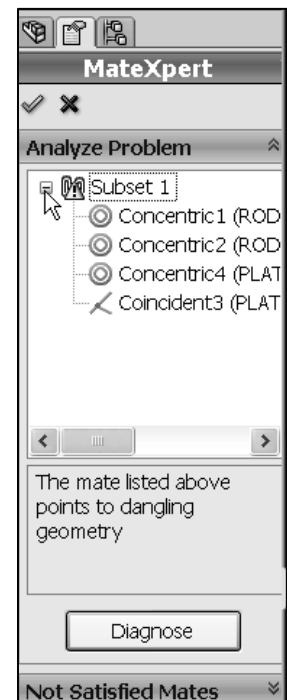

Diagnose Mating Problems

- Click **Tools, MateXpert**, or right-click the assembly, **Mates** folder, or any mate in the **Mates** folder, and click **MateXpert**.
- In the PropertyManager, under **Analyze Problem**, click **Diagnose**. One or more subsets of mates with problems are displayed. In the Graphics window, components that are not related to the current subset become transparent. A message is displayed with information on the mating problem.
-  Under **Not Satisfied Mates**, click a mate. The entities in the unsolved mate are highlighted in the Graphics window. A message tells you the distance or angle by which the mated entities are currently misaligned.

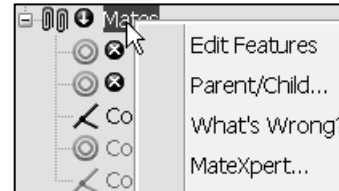
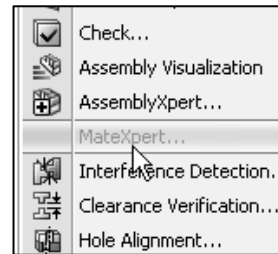

 Mates that appear under both **Analyze Problem** and **Not Satisfied Mates** appear in bold.

Activity: Insert SmartMates between PLATE-A and the RODLESS-CYLINDER Assembly

Hide the MYM1M2104Tubes part.

170) Right-click **MY1M2104Tubes** from the FeatureManager.

171) Click **Hide components** from the Context toolbar. View the results.

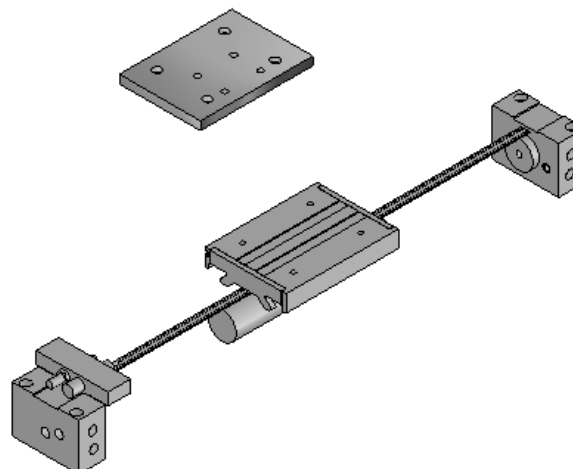
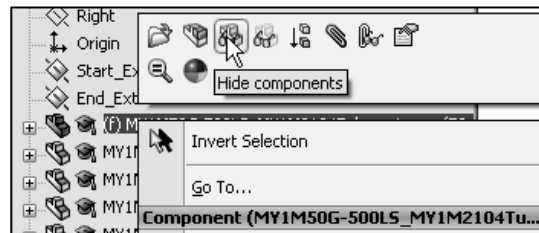

Insert a Concentric SmartMate.

172) Hold the **Alt** key down.

173) Click and drag the PLATE-A **CBORE** face to the front right Table_Hole face, as illustrated. The Concentric icon is displayed. Note: Zoom in on the selected area.

174) Release the **Alt** key. Release the **mouse** button. Concentric is selected by default from the Mate Pop-up menu.

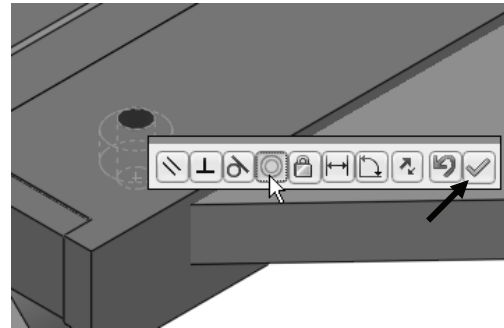
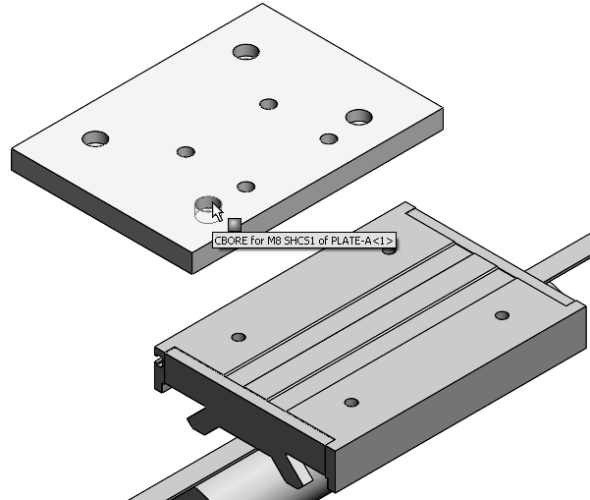

175) Click the **Green Check mark** ✓.

176) Expand the Mates folder from the FeatureManager. View the created mate.

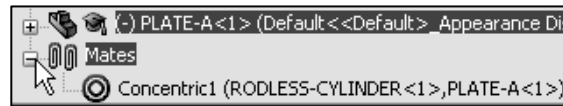

Move the PLATE-A part.

177) Drag the **PLATE-A** part upward until you view the upper left CBORE as illustrated.

Fit the model to the Graphics window. Zoom out.

178) Press the lower case **z** key until the MYM2104Table part and the PLATE-A part are displayed in the Graphics window.

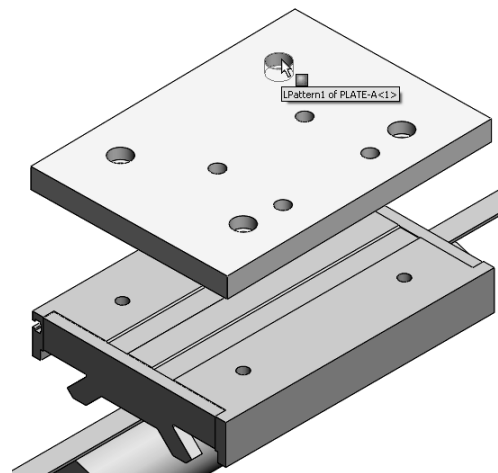

Insert the second Concentric SmartMate.

179) Hold the **Alt** key down.

180) Click and drag the **PLATE-A CBORE face** to the back left **Table_Hole** as illustrated.

The Concentric  icon is displayed.

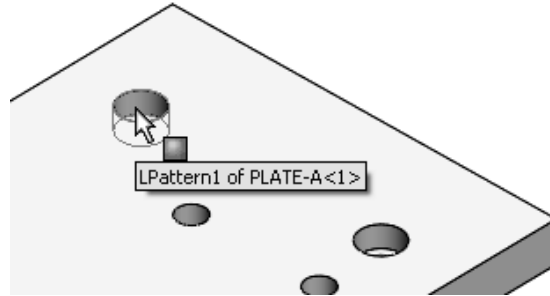

181) Release the **Alt** key. Concentric is selected by default from the Mate Pop-up menu.

182) Click the **Green Check mark** .

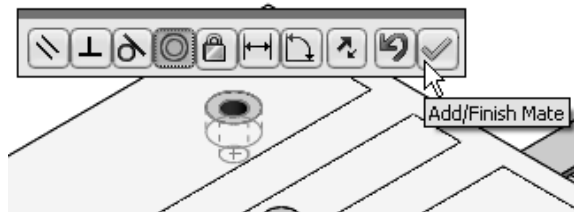

View the created Mate.

183) **Expand** the Mates folder from the FeatureManager. View the second inserted Concentric Mate.

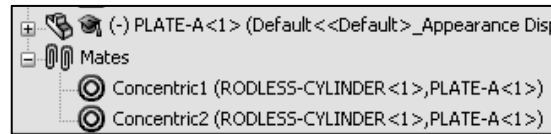

Insert a Coincident SmartMate.

184) Click and drag **PLATE-A** upward and rotate until its bottom face is visible.

185) Click the **Move Component**  tool from the Assembly toolbar. The Move Component PropertyManager is displayed.

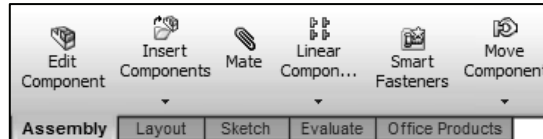

186) Click the **SmartMates**  icon in the Move box.

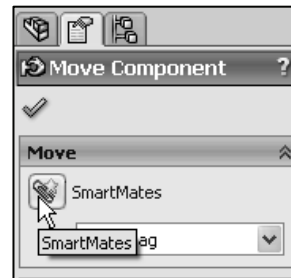

187) Double-click the **bottom face** of PLATE-A. The SmartMate  icon is displayed.

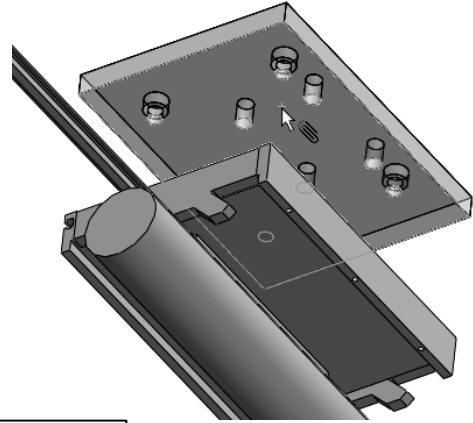

188) Click **table-view** from the Heads-up View toolbar. Note: The table-view was created in the previous section.

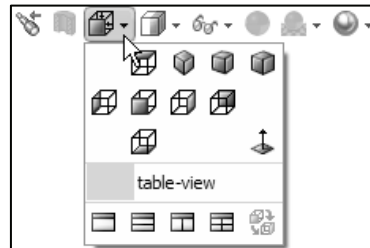

189) Click the **top face** of the MYM2104Table as illustrated. Coincident is selected by default from the Mate Pop-up.

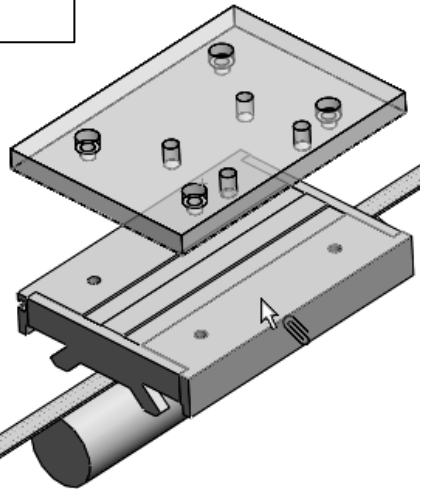

190) Click the **Green Check mark** .

191) Click **OK**  from the SmartMates PropertyManager.

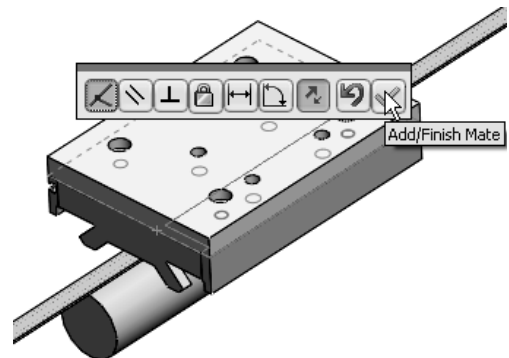
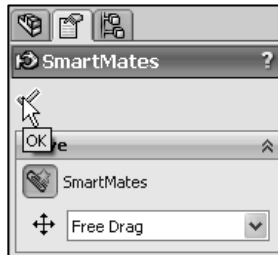

Show the MYM1M2104Tubes part.

192) Right-click **MY1M2104Tubes** from the FeatureManager.

193) Click **Show components** from the Context toolbar.

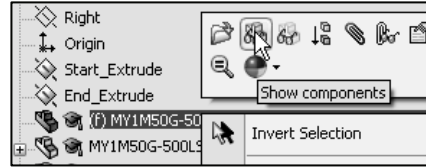

Expand the LINEAR-TRANSFER\Mates entry.

194) Expand the Mates folder from the LINEAR-TRANSFER FeatureManager. View the created Mates.

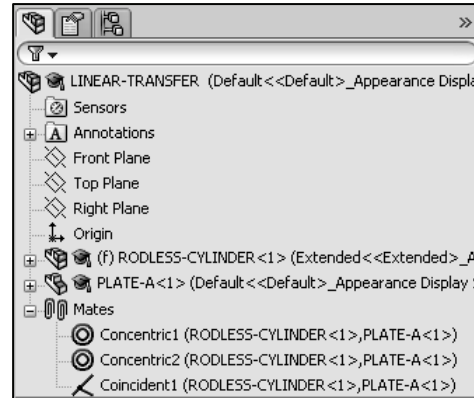

The three SmartMates created two Concentric Mates and one Coincident Mate. The PLATE-A part cannot translate or rotate.

 Design for change. For easier recognition, Mates that require future modification should be renamed to a descriptive name.

Note: Mate name numbers increment by one. If you delete a Mate and insert a new Mate in the same session of SolidWorks, the new Mate name is incremented by one.

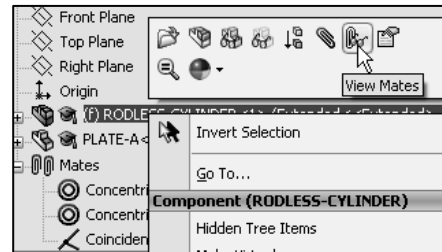

The View Mates option displays all the Mates for a selected component. Double-click on a mate in the pop-up dialog box as illustrated to view the location and options in the Graphic window.

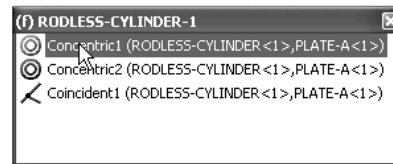

How do you enable the PLATE-A part to translate in the LINEAR-TRANSFER assembly?
Answer: Modify the Component Property Solve as option from Rigid to Flexible.

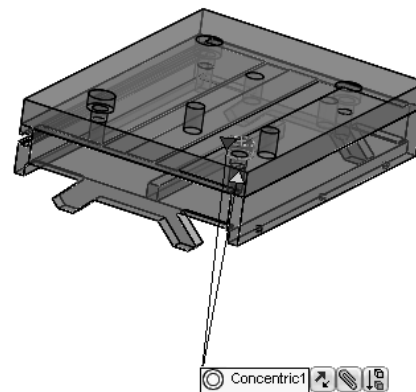

Rigid and Flexible

There are two states to solve Mates in an assembly:

- *Rigid*
- *Flexible*

By default, components inserted into an assembly solve Mates as Rigid. Rigid components do not translate or rotate.

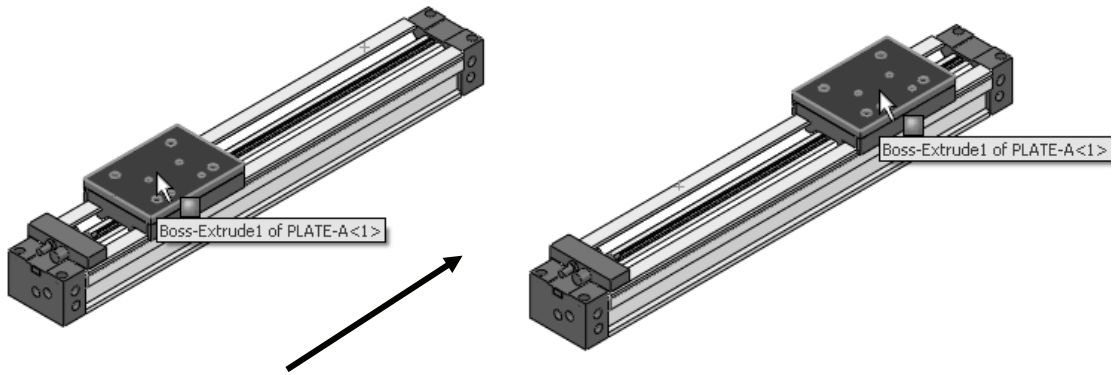
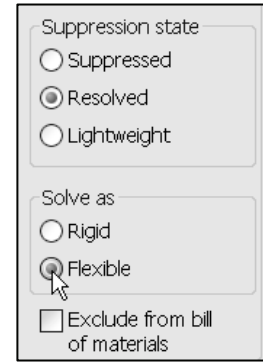

Flexible components translate or rotate based on the behavior of their Mates.

In the flexible state, the MY1M2104Table part and PLATE-A part are free to translate in the LINEAR-TRANSFER assembly.

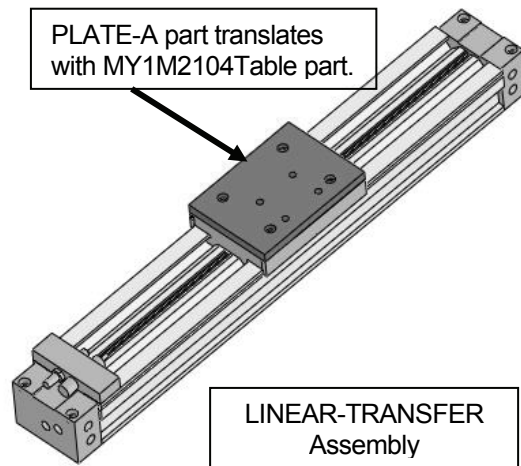

Activity: Modify the Rigid State to a Flexible State

Modify the Component Properties.

195) Right-click **RODLESS-CYLINDER** from the FeatureManager.

196) Click **Component Properties** from the Context toolbar. The Component Properties dialog box is displayed.

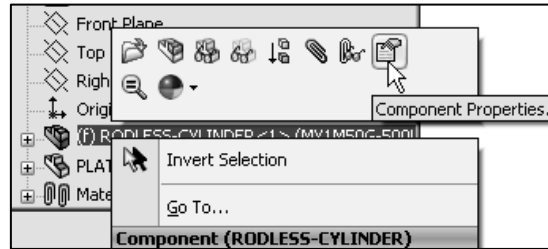

197) Check the **Flexible** box in the Solve as section as illustrated.

198) Click **OK** from the Component Properties dialog box. The flexible state parameter  is displayed in the FeatureManager at the component level.

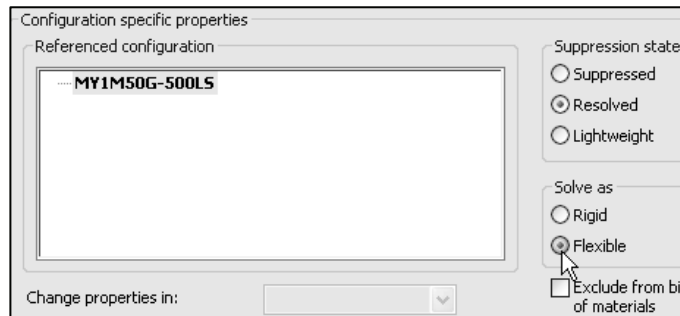

Move PLATE-A.

199) Click and drag the **PLATE-A** part in the LINEAR-TRANSFER assembly from left to right.

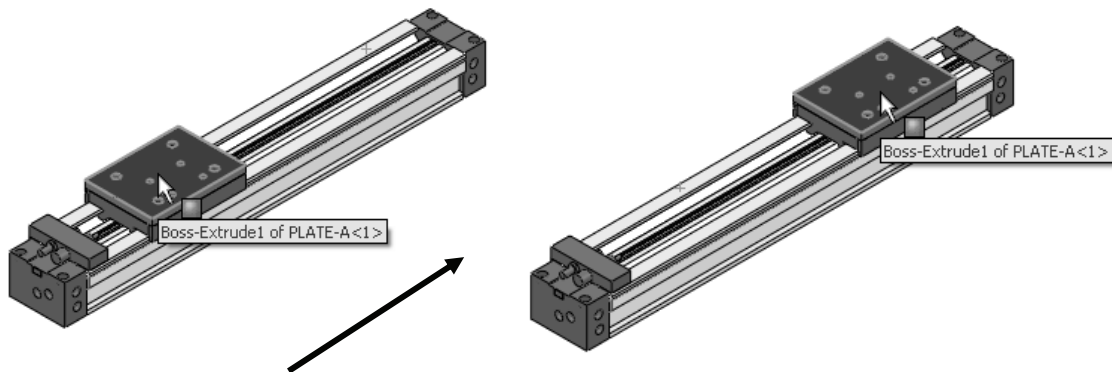
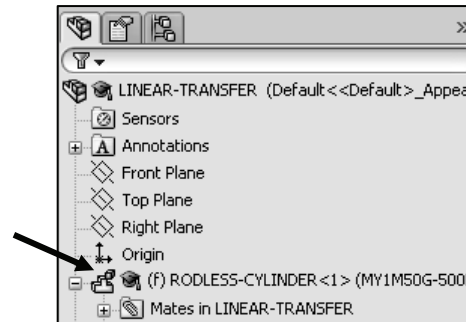

Save the LINEAR-TRANSFER assembly.

200) Click **Isometric** view.

201) Click **Save**.



Right-click the assembly name in the FeatureManager and click Set Lightweight to Resolved to fully resolve an Assembly.

Fasteners

Screws, bolts, and fasteners are used to join parts. Use standard available fasteners whenever possible. This will decrease product cost and reduce component purchase lead times. The American Society for Mechanical Engineers, (ASME) and the International Standardization Organization, (ISO) provides standards on various hardware components.

Below are general selection and design guidelines that are utilized in this text:

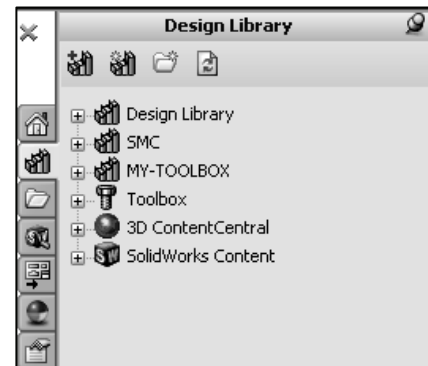

- Use standard industry fasteners where applicable.
- Utilize industry fasteners that are supplied by qualified vendors and suppliers.
- Know the customer geographic location of the assembly and the fastener when dealing with both millimeter and inch units.
- Reuse common fastener types where applicable. Dissimilar screws and bolts may require additional tools for assembly, additional part numbers and increase inventory storage and cost.
- Decide on the fastener type before creating holes. Dissimilar fastener types require different geometry.
- Create notes on all fasteners. This will assist in the development of a Parts list and Bill of Materials.
- Caution should be used in positioning holes. Do not position holes too close to an edge. Review manufacturer's specifications for punching and machining to determine minimum hole spacing.
- Design for service support. Ensure that the model can be serviced in the field and or on the production floor.

Use a standard M8 x 1.25 SHCS in this exercise. Note: The Threads are suppressed in this section.

- M8 represents a metric screw: 8mm major outside diameter.
- 1.25 thread pitch (mm per thread).



Determine the proper overall length with the Measure tool from the Evaluate toolbar.

How do you determine the proper overall length of the M8 SHCS?

Answer: The depth of PLATE-A (15mm) plus the required blind depth of the Table-Hole (15mm) provided by the manufacturer. The SHCS top is recessed, below the top face of the Table.

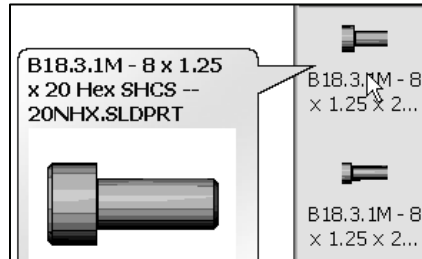

When using fasteners to connect plates, a rule of thumb is to use at least 75% - 85% of the second plate blind depth to avoid fastener failure.

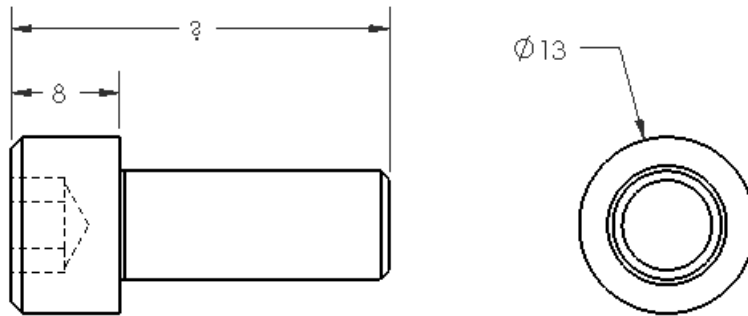

In some processes, it is easier to manufacture a thru thread, rather than a blind one. In this instance, have a least enough thread engagement to equal the diameter of the fastener.

The metric fasteners from your supplier are available in 5mm increments for lengths greater than 20mm.

Determine the length of the fastener.

- PLATE-A thickness = 15mm.
- Table-Hole blind depth = 15mm.
- Height of the 8M x 1.25 Socket Head = 8mm.
- Length = (PLATE-A thickness + Table_Hole blind depth) – Height Socket Head.
- Length = 15mm + 15mm – 8mm = 22mm.

What length do you utilize; 20mm or 25mm? Answer: 20mm. The 20mm SHCS is engaged within 75% - 85% of the Table_Hole blind depth. The 25mm is too long since the holes are drilled and tapped at the vendor's facility.



A few screw manufacturers produce a 22mm SHCS, however, your machine shop does not stock this size. Integrating a new part number for hardware costs time and money.

You decide the 20mm SHCS is your choice. SolidWorks Toolbox automatically creates two SmartMates between the SHCS and the CBORE Hole. Copies of the SolidWorks Toolbox SHCS required for this chapter are located in the MY-TOOLBOX\SHCS folder.

Utilize the SHCS copies in the next activity to explore SmartMates between Graphic windows. Review the optional method of utilizing SolidWorks\Toolbox directly.

Toolbox parts are listed in the FeatureManager in two ways:

- Configuration Name: B18.31M-8x1.25x20Hex SHCS-20NHX.
- User defined name: SHC-91.

The B18.3.1M-8x1.25x20 Hex SHCS – 20NHX configuration name is defined as follows:

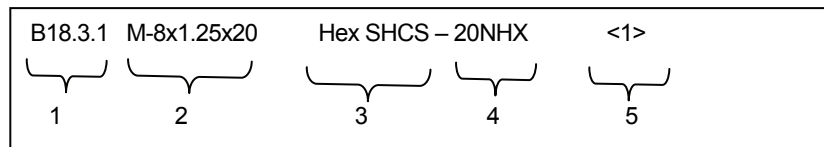

1. B18.3.1M is the ASME B18.3.1M Socket Head Cap Screw Metric Standard.
2. M-8x1.25x20:
 - M is Metric, 8mm is the diameter; 1.25 is the thread pitch, 20 is the length.
3. Hex SHCS is the fastener type.
4. 20NHX is the length of thread.
5. <1> is the first instance of the SHCS.

The User defined name corresponds to the part number utilized by Manufacturing, Purchasing and Inventory personnel.

Open the B18.3.1M-8x1.25x20 Hex SHCS – 20 NHX part. Drag the SHCS part into the LINEAR-TRANSFER assembly. Utilize the Concentric/Coincident SmartMates  to position the SHCS in the PLATE-A Cbore.

The Concentric Mate aligns the SHCS to the cylindrical face of the Cbore. The Coincident Mate aligns the screw head bottom edge to the PLATE-A Cbore bottom edge.

Component Patterns

A pattern repeats the selected features in an array based on a seed feature. You can create a Linear pattern, Circular pattern, Curve Driven pattern, Fill pattern, or use sketch points or table coordinates to create your own pattern.

You can create a pattern of components in the assembly in one of the following ways:

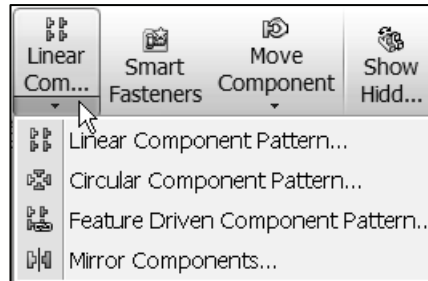

- You can create a Linear Component Pattern or a Circular Component pattern. A Linear pattern creates multiple instances of selected components along one or two linear paths. A Circular Pattern creates multiple instances of selected components about an axis.
- You can place a pattern of components in an assembly based on a feature pattern of an existing component. This is called a Feature Derived Component Pattern. A Feature Driven Component Pattern (Derived) creates multiple instances of selected components based on an existing pattern.

 Mirror copies the selected features or all features, mirroring them about the selected plane or face.

 To toggle the visibility or suppression state of all of the components in the pattern, right-click the pattern feature in the FeatureManager design tree, and select **Hide components**, **Show components**, **Suppress**, **Unsuppress** or **Isolate components**.

Utilize a Feature Driven Component Pattern to copy the SHCSs based on the PLATE-A Linear Pattern of Cbores.

Activity: Apply Toolbox -Fasteners – SmartMate

Open the SHCS folder in the Design Library.

202) Expand the MY-TOOLBOX folder in the Design Library.

203) Click the SHCS folder.

204) Right-click on the **B18.3.1M-8x1.25x20 Hex SHCS - 20 NHX** icon.

205) Click Open. The Hex SHCS is displayed in the Graphics window.

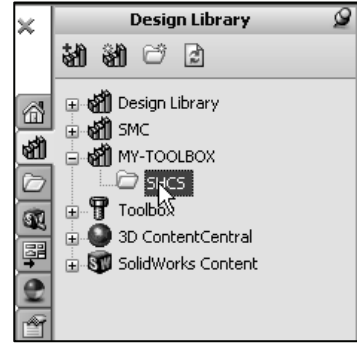

Display an Isometric view.

206) Click Isometric view from the Heads-up View toolbar.

Insert the Hex SHCS.

207) Click Window, Tile Horizontally from the Menu bar menu.

208) Zoom in and **Rotate** the LINEAR-TRANSFER assembly until the inside seed Cbore is displayed.

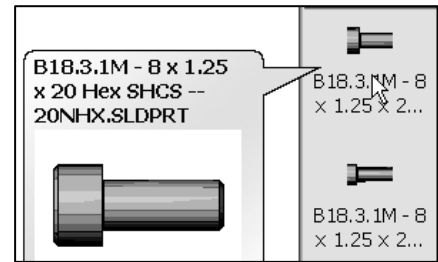

209) Click and drag the **bottom circular edge** of the SHCS to the inside bottom circular edge of the Cbore. The mouse pointer displays the Concentric/Coincident SmartMates .

210) Release the left mouse button to create the two SmartMates.

211) Maximize the LINEAR-TRANSFER assembly.

Fit the Model to the Graphics window.

212) Press the f key.

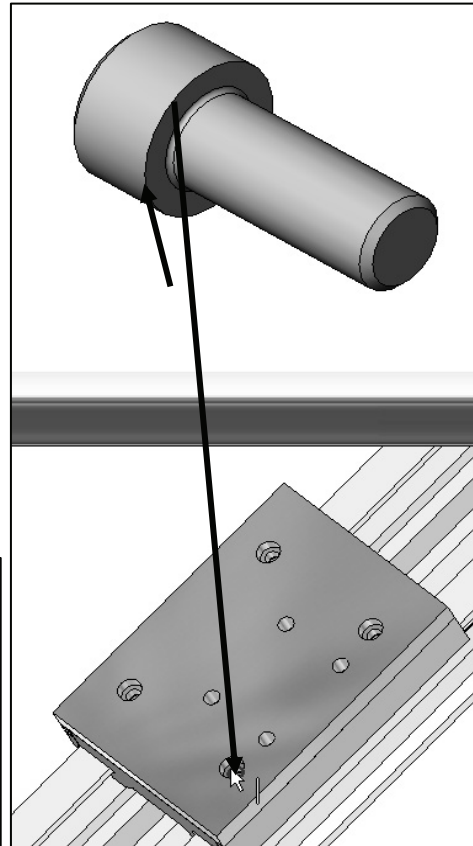
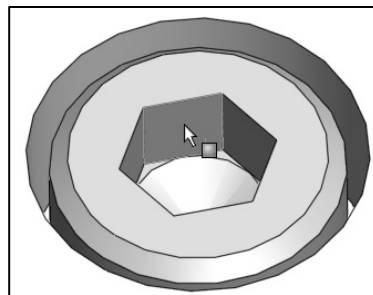
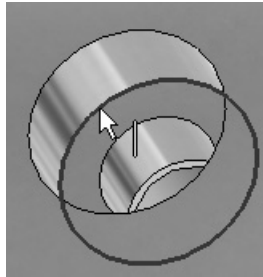

Review the Inserted mates.

213) Expand the Mates folder from the FeatureManager.
View the created mates.

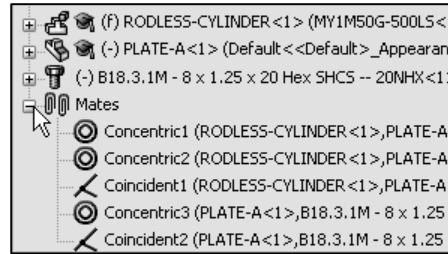

The SHCS is free to rotate about its axis. Multiple Hex-shaped fasteners require a Parallel Mate to orient faces in the same direction. Fully defined fasteners rotate together.

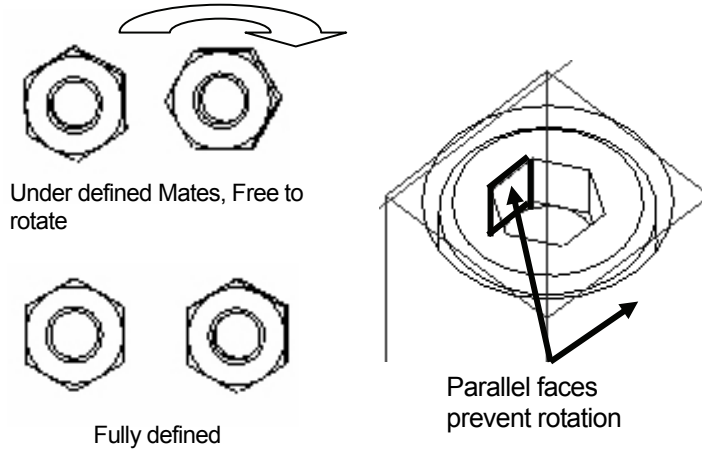

An additional Parallel Mate between the Hex head face and the PLATE-A narrow face prevents rotation.

The SHCS top face is positioned below the PLATE-A top face, there are no interferences. No Parallel Mate is created to fully define the SHCS.

 Save mate time and rebuild time. Utilize a Concentric/Coincident Mate for screws, nuts, washers, and bolts. Utilize the Parallel Mate to locate the head direction for hex geometry when required for interference detection or appearance.

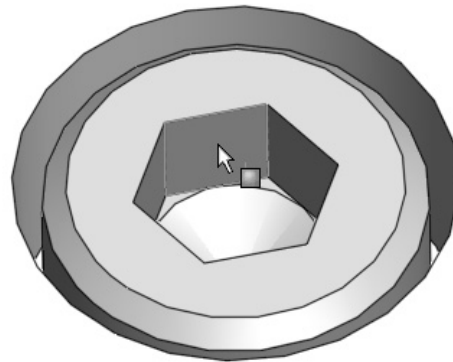

Create a Feature Driven Component Pattern.

214) Click the **Feature Driven Component Pattern** tool from the Consolidated Assembly toolbar. The Feature Driven PropertyManager is displayed. B18.3.1M-8x1.25x20 Hex SHCS - 20 NHX is displayed in the Components to Pattern box.

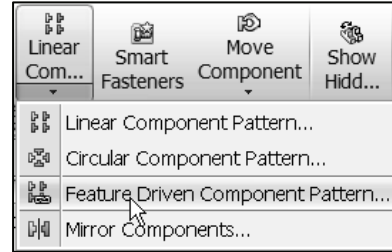

215) Click a **position** inside the Driving Feature box.

216) **Expand** PLATE-A<1> from the Flyout FeatureManager.

217) Click **LPattern1**. LPattern1 is displayed in the Driving Feature box.

218) Click **OK** from the Feature Driven PropertyManager.

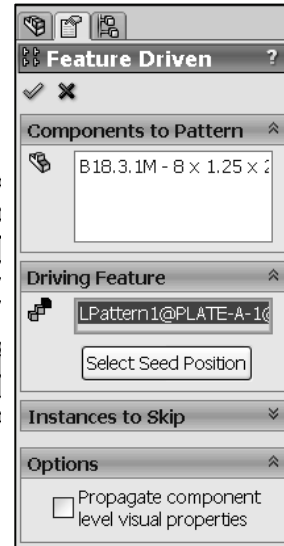
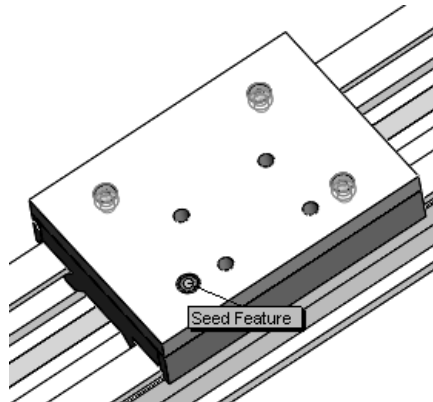

DerivedLPattern1 is listed in the assembly FeatureManager and contains three instances of the SHCS.

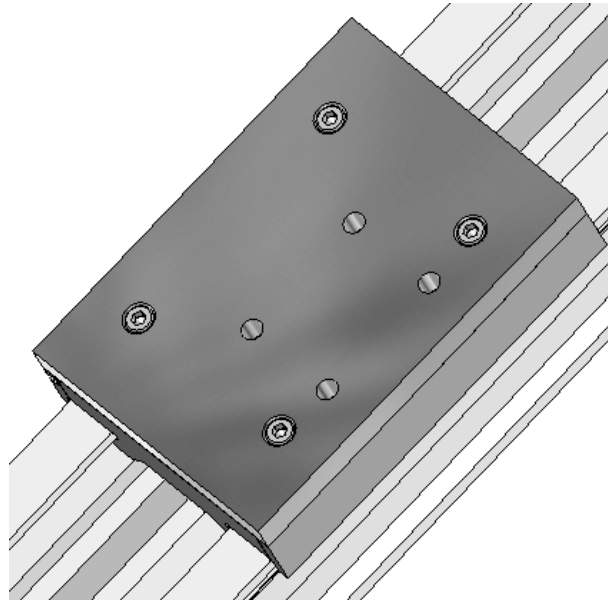
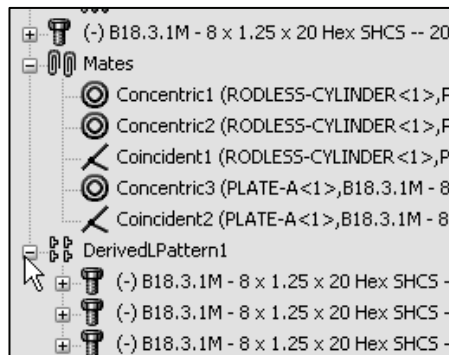

Save the LINEAR-TRANSFER assembly.

219) Click **Isometric** view from the Heads-up View toolbar.

220) Click **Save**.

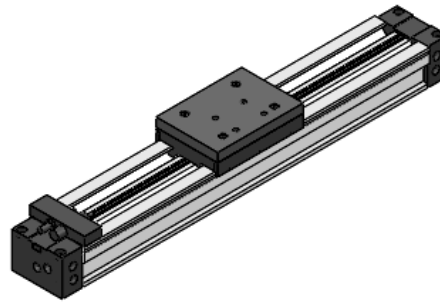

Activity: Set the Toolbox directory

Activate the Toolbox Browser.

221) Click **Add-Ins** from the Menu bar toolbar.

222) Check the **SolidWorks Toolbox** box and the **Toolbox Browser** box.

223) Click **OK** from the Add-Ins box.

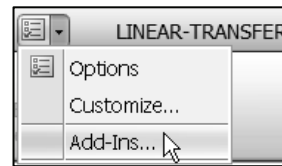

Set the Toolbox directory.

224) Click **Toolbox** from the Menu bar menu.

225) Click **Configure**. The Welcome to Toolbox Setup dialog box is displayed.

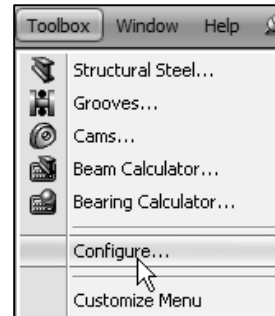

226) Click **Define user settings**.

227) Check the **Create Parts on Ctrl-Drag** box.

228) Click **Browse**.

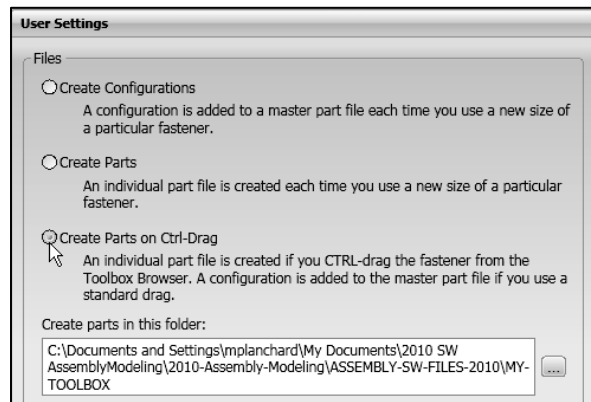

229) Select the **ASSEMBLY-SW-FILES-2010\MY-TOOLBOX** folder.

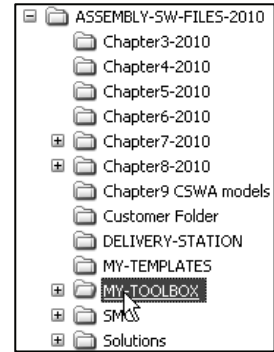

230) Click **OK** from the Browse For Folder dialog box.

231) Click **Close** from the Configure Data box.

An individual part file is created if you CTRL-drag the fastener from the Toolbox Browser.

Delete the existing SHCS and the Mates.

232) Right-click the **B18.3.1M-8x1.25x20 Hex SHCS - 20 NHX** from the FeatureManager.

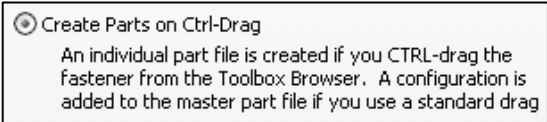

233) Right-click **Delete**.

234) Click **Yes** to delete dependent entities and mates. Note: DerivedLPattern1 is also deleted.



Insert a M8x1.25x20 Hex SHCS into the LINEAR-TRANSFER assembly.

235) **Zoom in** on the CBORE face of the lower right seed feature in the Graphics window

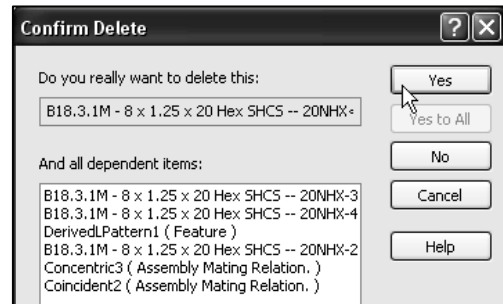

236) **Expand** the Toolbox folder from the Design Library.

237) **Expand** the Ansi Metric folder.

238) **Expand** the Bolts and Screws folder.

239) Click the **Socket Head Screws** folder.

240) Click and drag the **Cap (B18.3.1M)**  icon into the assembly Graphics window.



241) Release the **mouse pointer** on the CBORE face of the lower right seed feature. The Socket Head Cap Screw Properties dialog box is displayed.

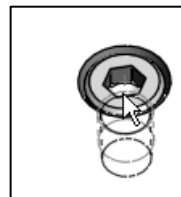

242) Enter **M8** for Size.

- 243)** Enter **20** for Length. Accept the default values.
- 244)** Click **OK** ✓ from the Socket Head Cap Screw PropertyManager.
- 245)** Insert the **second, third and fourth** M8x1.25x20 Hex SHCS into the LINEAR-TRANSFER assembly as illustrated.
- 246)** Click **Cancel** from the Insert Component PropertyManager.
- 247)** **Save** the model.

View the results in the FeatureManager and Graphics window.

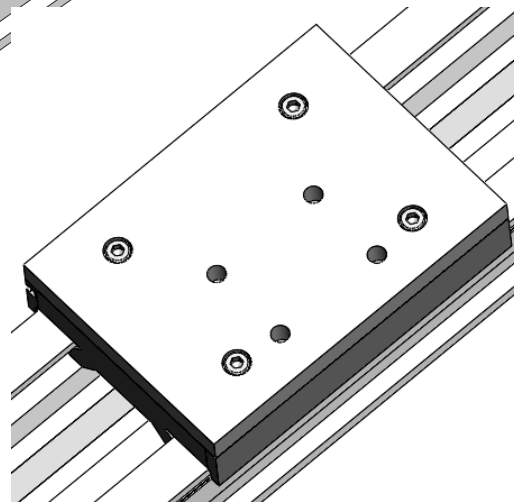
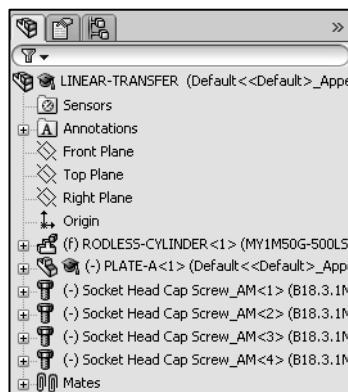
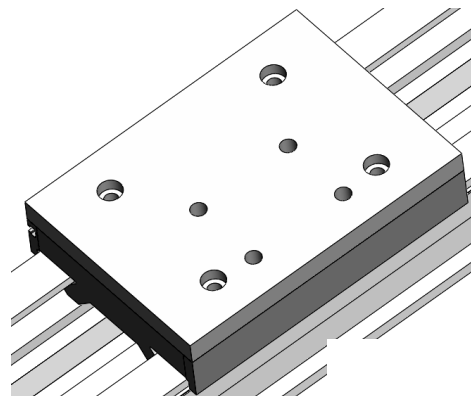
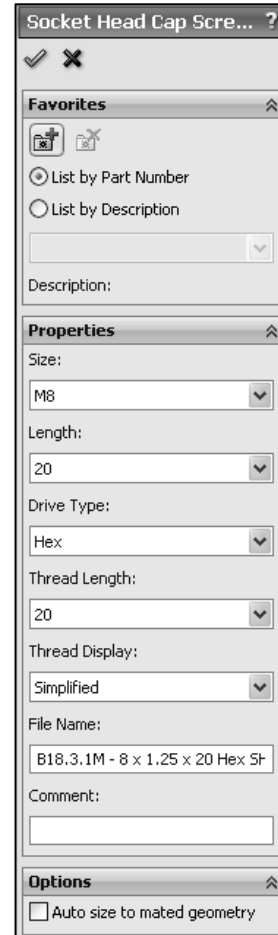

Chapter Summary

The Bottom-up design assembly modeling approach was utilized to create the LINEAR-TRANSFER assembly. The LINEAR-TRANSFER assembly is the first assembly in the 3AXIS-TRANSFER assembly.

You created the PLATE-A part based on the features of the RODLESS-CYLINDER\MY1M2104Table part and the GUIDE-CYLINDER assembly.

You utilized the Design Library Toolbox and inserted four M8x1.25x20 SHCS using SmartMates to assemble the PLATE-A part to the RODLESS-CYLINDER assembly

The LINEAR-TRANSFER assembly consisted of the RODLESS-CYLINDER assembly, the PLATE-A part and four M8x1.25x20 SHCS.

You utilized and applied the following SolidWorks tools and commands: *Mate, Mate Reference, SmartMate, Rotate Component, Move Component, Hole Wizard tool, Hide / Show components, Flexible, Rigid, Linear Pattern, Derived Component Pattern, Insert Part, Insert Component, Corner Rectangle, Extruded Base and Extruded Boss.*

 Solutions to each chapter; is provided in the Solutions folder on the CD in the book.

 Right-click the assembly name in the FeatureManager and click Set Lightweight to Resolved to fully resolve the Assembly.

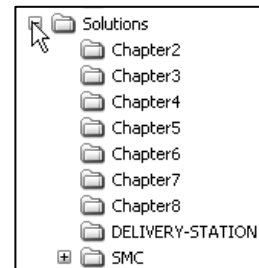
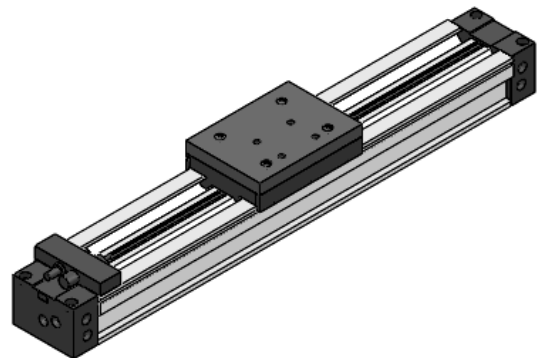
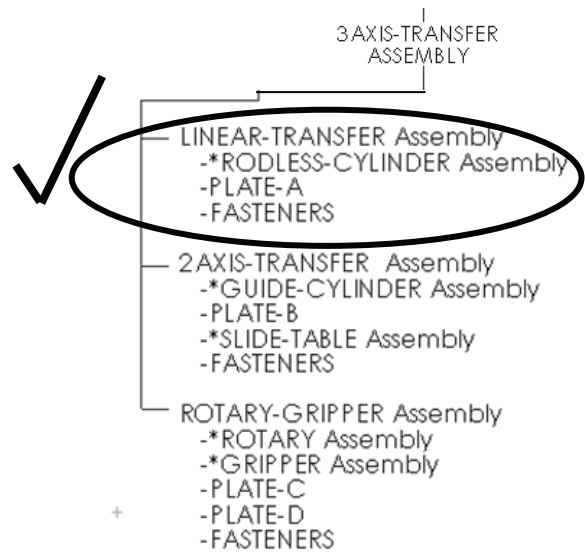

Questions

1. Describe the components and features utilized to determine the geometric and functional requirements of the PLATE-A part.
2. List the sketch tools and feature options that build symmetry into a part.
3. Identify the locations of the PLATE-A Reference planes.
4. True or False. The Hole Wizard does not require dimensions or relationships to define the position of a hole.
5. Assembling components in SolidWorks is defined as _____
6. Each component has _____ degrees of freedom.
7. Identify the view type that displays internal geometry.
8. Describe the difference between a Distance Mate with a 0 value and a Coincident Mate.
9. Describe the SHCS abbreviation. What does it stand for?
10. Identify the two SmartMates that are used to assemble a SHCS to a hole in the PLATE-A part.
11. Identify the command utilized to create a Component Pattern in an assembly that references an existing feature for another component.
12. A sub-assembly named Flexible is inserted into an assembly. The Flexible sub-assembly is Rigid. Identify the option that would regain a flexible state?
13. Review the SmartMate .avi files with SW help. Identify other types of Smart Mates. Explain.

<u>Mating entities</u>	<u>Type of mate</u>	<u>Pointer</u>	<u>Click for example</u>
2 linear edges	Coincident		
2 planar faces	Coincident		
2 vertices	Coincident		
2 conical faces, or 2 axes, or 1 conical face and 1 axis	Concentric		
2 circular edges (the edges do not have to be complete circles)	Concentric (conical faces) - and - Coincident (adjacent planar faces)		

Chapter 4

Bottom-up Design Approach - Two Levels of Configurations

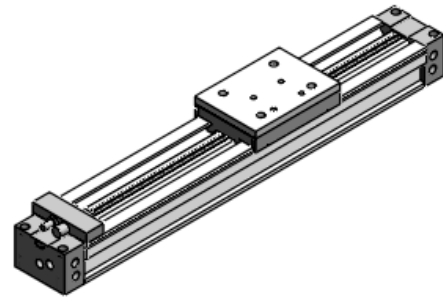
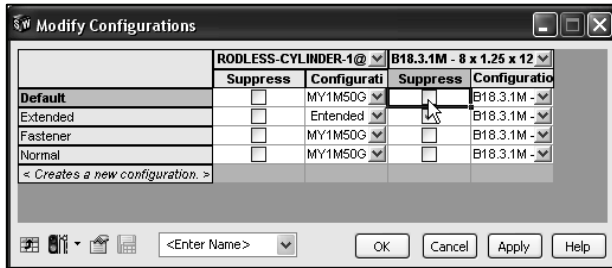

Below are the desired outcomes and usage competencies based on the completion of this Chapter.

Chapter Desired Outcomes:	Usage Competencies:
<ul style="list-style-type: none"> • Two RODLESS-CYLINDER configurations: <ul style="list-style-type: none"> ○ <i>Normal</i> ○ <i>Extended</i> 	<ul style="list-style-type: none"> • Understand the different ways to create assembly configurations. • Comprehend and apply the Configure Component tool.
<ul style="list-style-type: none"> • Two Levels of Configuration using the Bottom-up design approach of the LINEAR-TRANSFER assembly: <ul style="list-style-type: none"> ○ <i>Normal</i> ○ <i>Extended</i> ○ <i>Fastener</i> 	<ul style="list-style-type: none"> • Aptitude to manage components and to create configurations at various levels of the assembly. • Create a Derived Feature Component Pattern. • Apply the Collision Detection tool.