

# Learning SolidWorks® 2013

Modeling, Assembly and Analysis

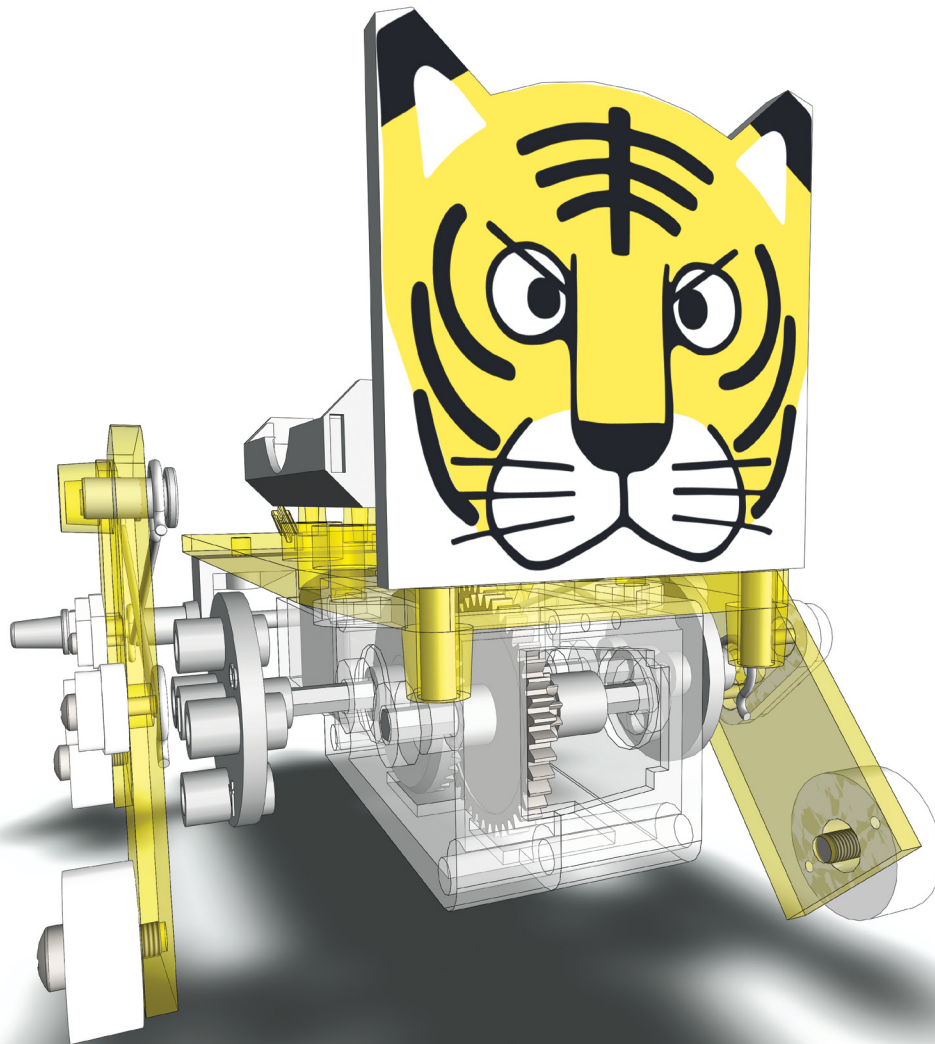

Randy H. Shih

Visit the following websites to learn more about this book:



[amazon.com](https://www.amazon.com)

[BARNES & NOBLE](https://www.barnesandnoble.com)

[Google books](https://books.google.com)

## Chapter 2

# Parametric Modeling Fundamentals

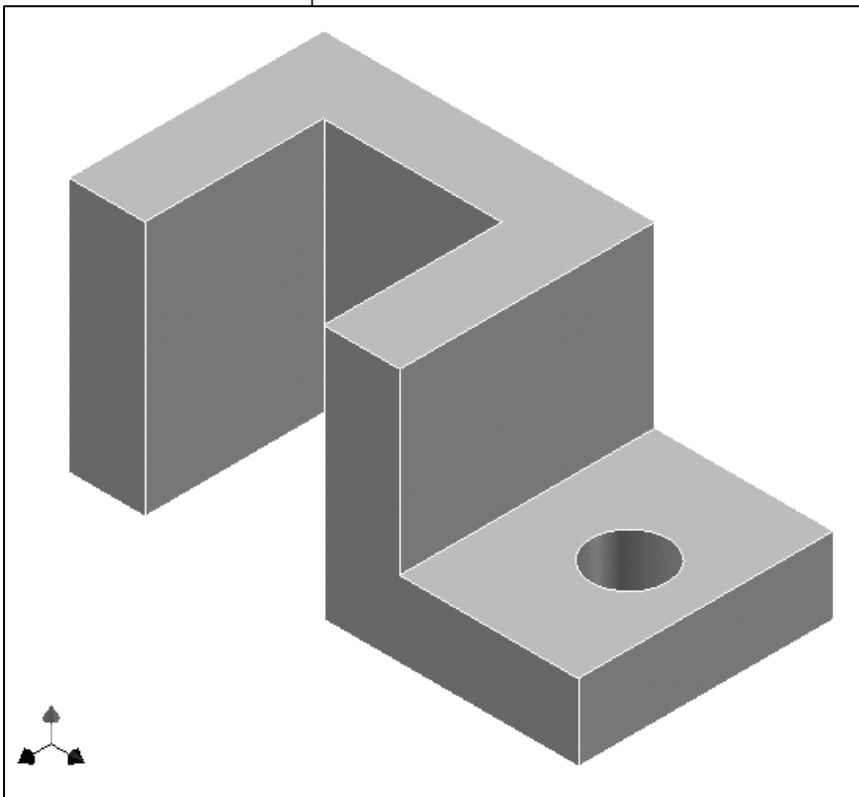

### Learning Objectives

- ◆ Create Simple Extruded Solid Models
- ◆ Understand the Basic Parametric Modeling Procedure
- ◆ Create 2-D Sketches
- ◆ Understand the “Shape before Size” Design Approach
- ◆ Use the Dynamic Viewing Commands
- ◆ Create and Edit Parametric Dimensions

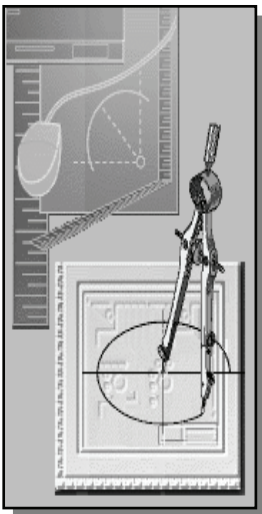

## Introduction

The **feature-based parametric modeling** technique enables the designer to incorporate the original **design intent** into the construction of the model. The word *parametric* means the geometric definitions of the design, such as dimensions, can be varied at any time in the design process. Parametric modeling is accomplished by identifying and creating the key features of the design with the aid of computer software. The design variables, described in the sketches and described as parametric relations, can then be used to quickly modify/update the design.

In *SolidWorks*, the parametric part modeling process involves the following steps:

1. **Determine the type of the base feature, the first solid feature, of the design. Note that *Extrude*, *Revolve*, or *Sweep* operations are the most common types of base features.**
2. **Create a rough two-dimensional sketch of the basic shape of the base feature of the design.**
3. **Apply/modify constraints and dimensions to the two-dimensional sketch.**
4. **Transform the two-dimensional parametric sketch into a 3D feature.**
5. **Add additional parametric features by identifying feature relations and complete the design.**
6. **Perform analyses/simulations, such as finite element analysis (FEA) or cutter path generation (CNC), on the computer model and refine the design as needed.**
7. **Document the design by creating the desired 2D/3D drawings.**

The approach of creating two-dimensional sketches of the three-dimensional features is an effective way to construct solid models. Many designs are in fact the same shape in one direction. Computer input and output devices we use today are largely two-dimensional in nature, which makes this modeling technique quite practical. This method also conforms to the design process that helps the designer with conceptual design along with the capability to capture the *design intent*. Most engineers and designers can relate to the experience of making rough sketches on restaurant napkins to convey conceptual design ideas. *SolidWorks* provides many powerful modeling and design-tools, and there are many different approaches to accomplishing modeling tasks. The basic principle of **feature-based modeling** is to build models by adding simple features one at a time. In this chapter, the general parametric part modeling procedure is illustrated; a very simple solid model with extruded features is used to introduce the *SolidWorks* user interface. The display viewing functions and the basic two-dimensional sketching tools are also demonstrated.

## The Tiger Head Design

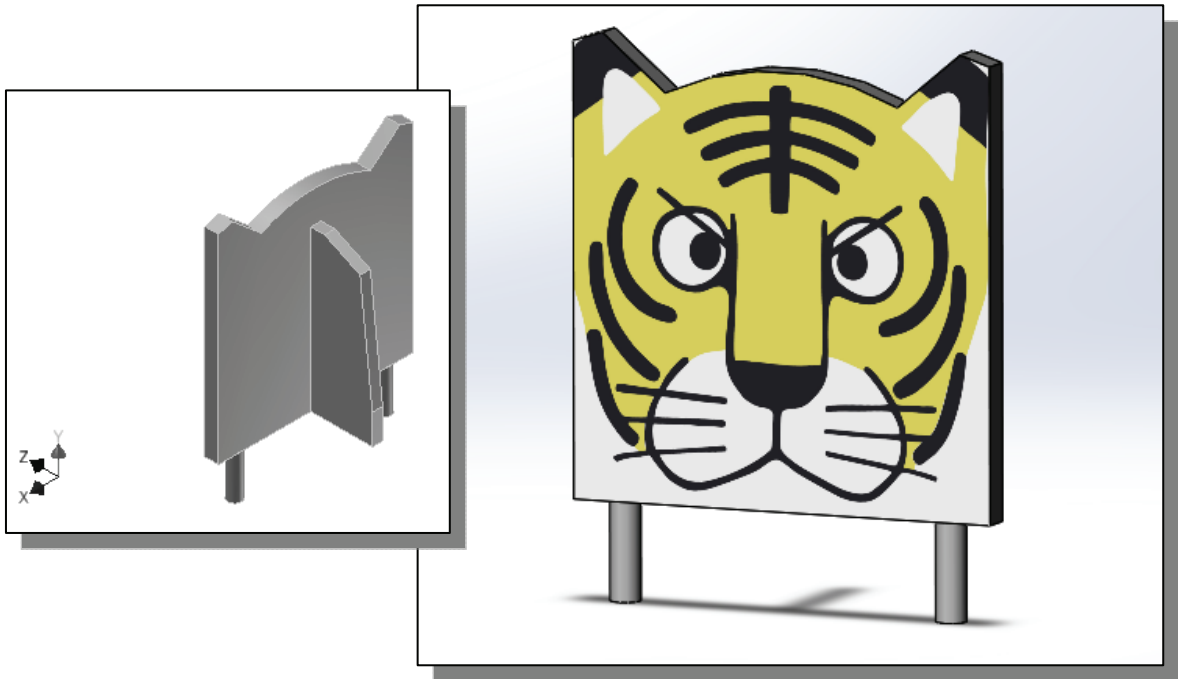

## Starting SolidWorks



1. Select the **SolidWorks** option on the *Start* menu or select the **SolidWorks** icon on the desktop to start *SolidWorks*. The *SolidWorks* main window will appear on the screen.

2. Select the **New** icon on the *Menu Bar* with a single click of the left-mouse-button. The *New SolidWorks Document* dialog box appears.

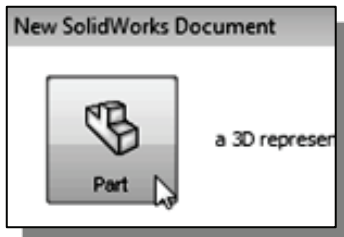

3. Select **Part** by clicking on the first icon in the *New SolidWorks Document* dialog box as shown.

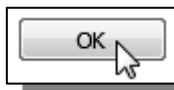

4. Click on the **OK** button to accept the settings.

## SolidWorks Screen Layout

The default *SolidWorks* drawing screen contains the *Menu Bar*, the *Heads-up View* toolbar, the *Feature Manager Design Tree*, the *Command Manager* toolbar the graphics area, the *task pane* (collapsed to the right of the graphics area in the figure below), and the *Status Bar*. A line of quick text appears next to the icon as you move the *mouse cursor* over different icons. You may resize the *SolidWorks* drawing window by click and drag on the edge of the window, or relocate the window by click and drag on the *window title* area.

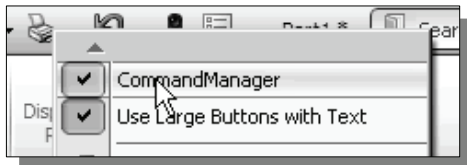
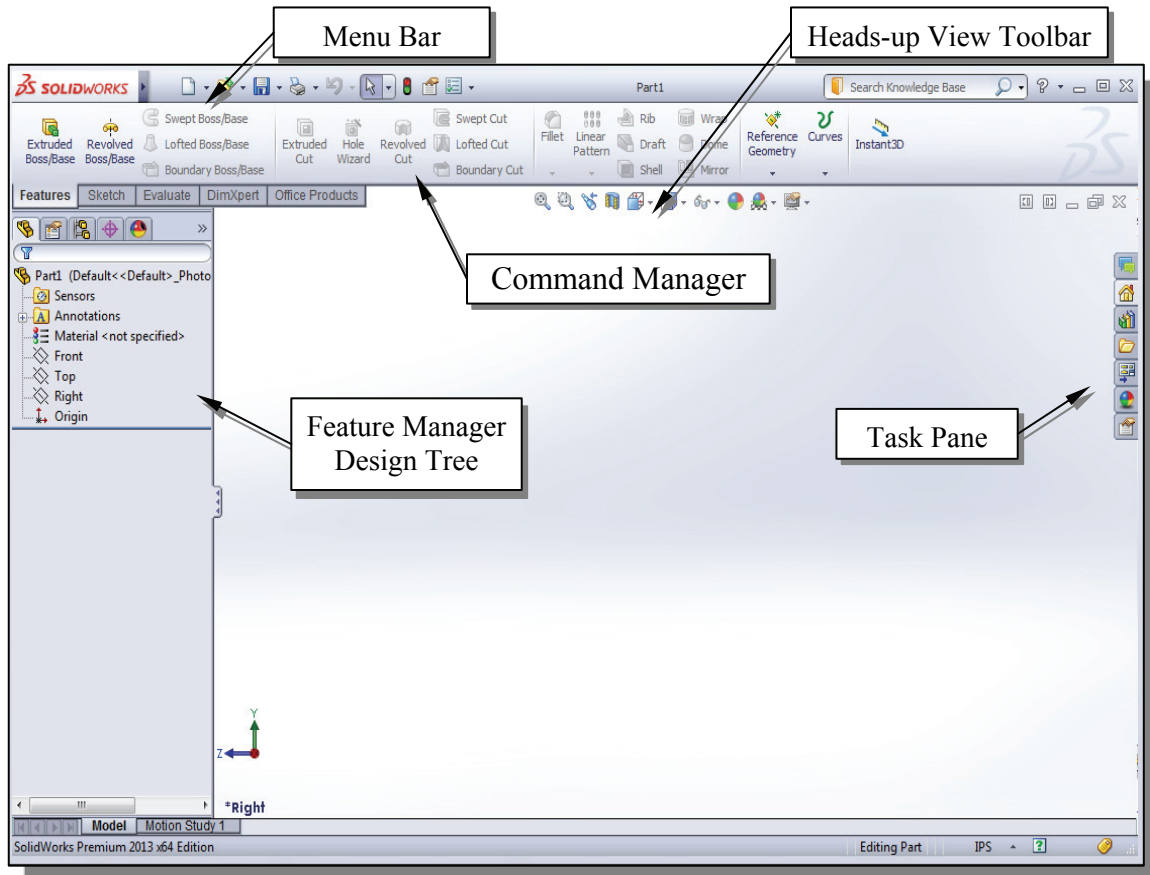

5. In the *Standard* toolbar area, **right-mouse-click** on any icon and activate **Command Manager** in the option list if necessary.

6. Select the **Options** icon from the *Menu* toolbar to open the *Options* dialog box.

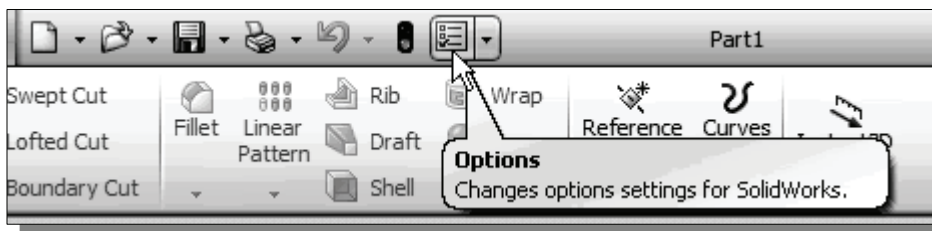

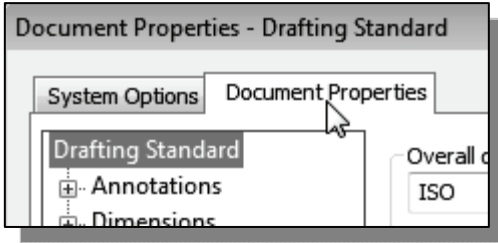

7. Select the **Document Properties** tab as shown in the figure.

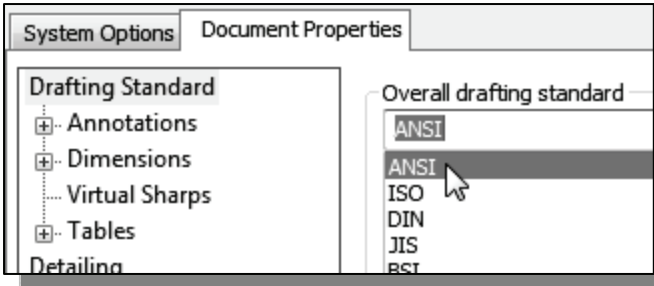

8. Set the *Overall drafting standard* to **ANSI** as shown.

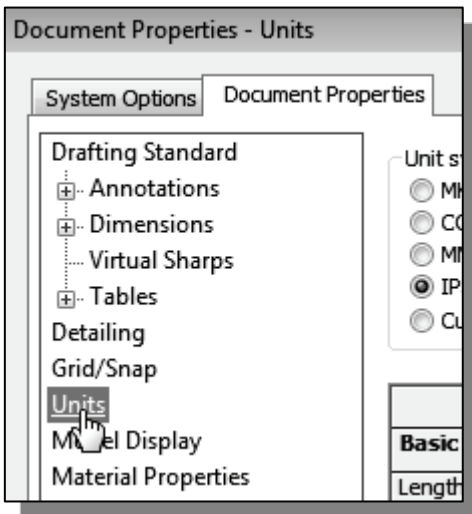

9. Click **Units** as shown in the figure.

10. Select **IPS (inch, pound, second)** under the *Unit system* options.

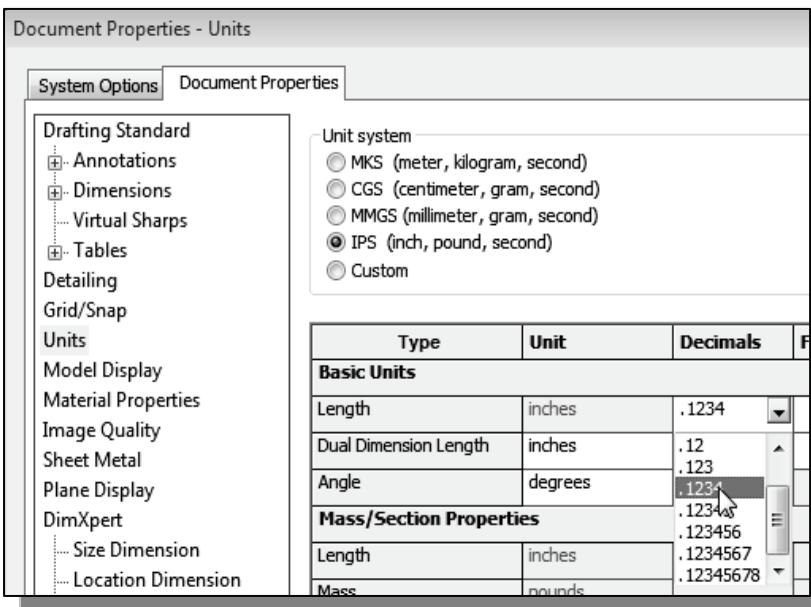
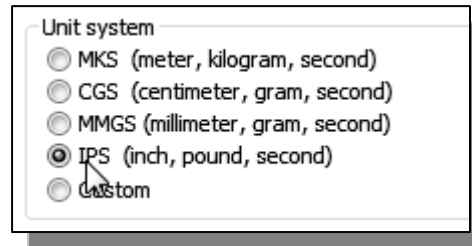

- Note the different options available to set/adjust the display of the selected units set.

11. Click **OK** in the *Options* dialog box to accept the selected settings.

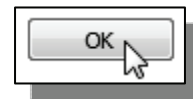

## Step 1: Determine/Setup the Base Solid Feature

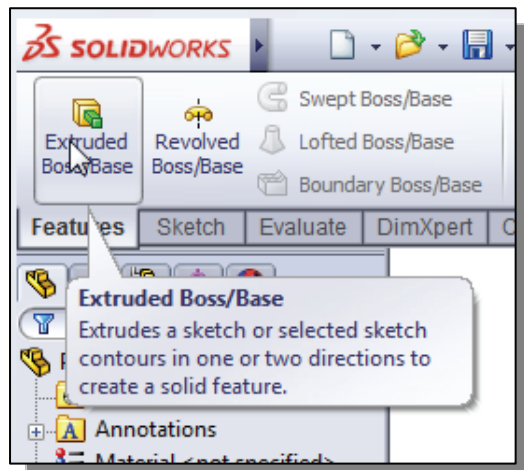

1. In the *Features* toolbar select the **Extruded Boss/Base** command by clicking once with the left-mouse-button on the icon.

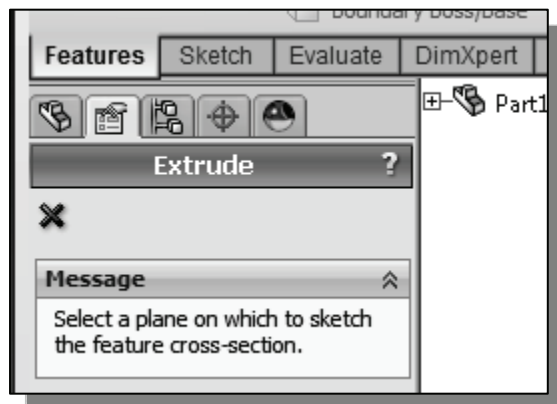

- Note the *Extrude Property Manager* is displayed in the left panel. We have activated the extrude feature; *SolidWorks* requires the use of an existing 2D sketch or the creation of a new 2D sketch.

## Sketching plane – It is an XY CRT, but an XYZ World

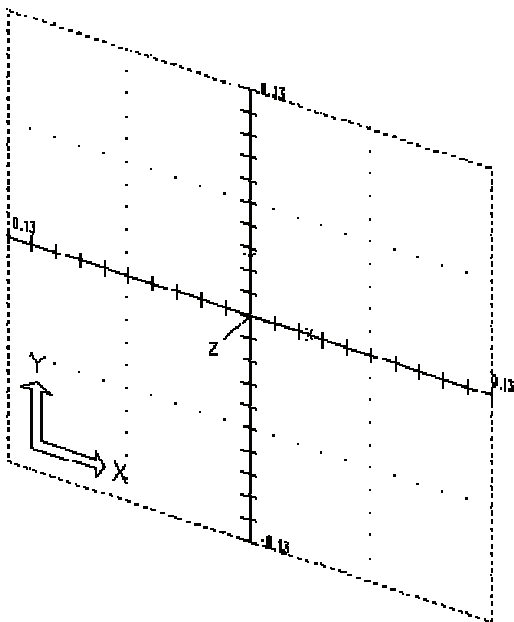

Design modeling software is becoming more powerful and user friendly, yet the system still does only what the user tells it to do. When using a geometric modeler, we therefore need to have a good understanding of what its inherent limitations are.

In most 3D geometric modelers, 3D objects are located and defined in what is usually called **world space** or **global space**. Although a number of different coordinate systems can be used to create and manipulate objects in a 3D modeling system, the objects are typically defined and stored using the world space. The world space is usually a **3D Cartesian coordinate system** that the user cannot change or manipulate.



In engineering designs, models can be very complex, and it would be tedious and confusing if only the world coordinate system were available. Practical 3D modeling systems allow the user to define **Local Coordinate Systems (LCS)** or **User Coordinate Systems (UCS)** relative to the world coordinate system. Once a local coordinate system is defined, we can then create geometry in terms of this more convenient system.

Although objects are created and stored in 3D space coordinates, most of the geometric entities can be referenced using 2D Cartesian coordinate systems. Typical input devices such as a mouse or digitizer are two-dimensional by nature; the movement of the input device is interpreted by the system in a planar sense. The same limitation is true of common output devices, such as CRT displays and plotters. The modeling software performs a series of three-dimensional to two-dimensional transformations to correctly project 3D objects onto the 2D display plane.

The *SolidWorks sketching plane* is a special construction approach that enables the planar nature of the 2D input devices to be directly mapped onto the 3D coordinate system. The *sketching plane* is a local coordinate system that can be aligned to an existing face of a part, or a reference plane.

Think of the sketching plane as the surface on which we can sketch the 2D sections of the parts. It is similar to a piece of paper, a white board, or a chalkboard that can be attached to any planar surface. The first sketch we create is usually drawn on one of the established datum planes. Subsequent sketches/features can then be created on sketching planes that are aligned to existing **planar faces of the solid part** or **datum planes**.

1. Move the cursor over the edge of the **Front Plane** in the graphics area. When the **Front Plane** is highlighted, click once with the **left-mouse-button** to select the **Front Plane** as the sketch plane for the new sketch. The *sketching plane* is a reference location where two-dimensional sketches are created. The *sketching plane* can be any planar part surface or datum plane.

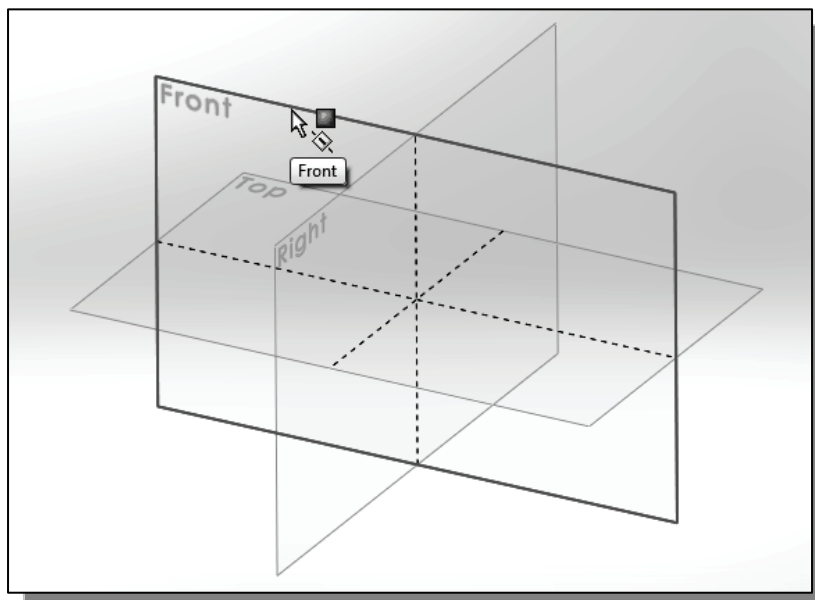

## Creating Rough Sketches

Quite often during the early design stage, the shape of a design may not have any precise dimensions. Most conventional CAD systems require the user to input the precise lengths and locations of all geometric entities defining the design, which are not available during the early design stage. With *parametric modeling*, we can use the computer to elaborate and formulate the design idea further during the initial design stage. With *SolidWorks*, we can use the computer as an electronic sketchpad to help us concentrate on the formulation of forms and shapes for the design. This approach is the main advantage of *parametric modeling* over conventional solid-modeling techniques.

As the name implies, a **rough sketch** is not precise at all. When sketching, we simply sketch the geometry so that it closely resembles the desired shape. Precise scale or lengths are not needed. *SolidWorks* provides us with many tools to assist us in finalizing sketches. For example, geometric entities such as horizontal and vertical lines are set automatically. However, if the rough sketches are poor, it will require much more work to generate the desired parametric sketches. Here are some general guidelines for creating sketches in *SolidWorks*:

- **Create a sketch that is proportional to the desired shape.** Concentrate on the shapes and forms of the design.
  - **Keep the sketches simple.** Leave out small geometry features such as fillets, rounds and chamfers. They can easily be placed using the **Fillet** and **Chamfer** commands after the parametric sketches have been established.
  - **Exaggerate the geometric features of the desired shape.** For example, if the desired angle is 85 degrees, create an angle that is 50 or 60 degrees. Otherwise, *SolidWorks* might assume the intended angle to be a 90-degree angle.
  - **Draw the geometry so that it does not overlap.** The geometry should eventually form a closed region. *Self-intersecting* geometry shapes are not allowed.
  - **The sketched geometric entities should form a closed region.** To create a solid feature, such as an extruded solid, a closed region is required so that the extruded solid forms a 3D volume.
- **Note:** The concepts and principles involved in *parametric modeling* are very different, and sometimes they are totally opposite, to those of conventional computer aided drafting. In order to understand and fully utilize *SolidWorks*'s functionality, it will be helpful to take a *Zen* approach to learning the topics presented in this text: **Have an open mind and temporarily forget your experiences using conventional Computer Aided Drafting systems.**

## Step 2: Creating a Rough Sketch

- The *Sketch* toolbar provides tools for creating the basic geometry that can be used to create features and parts.

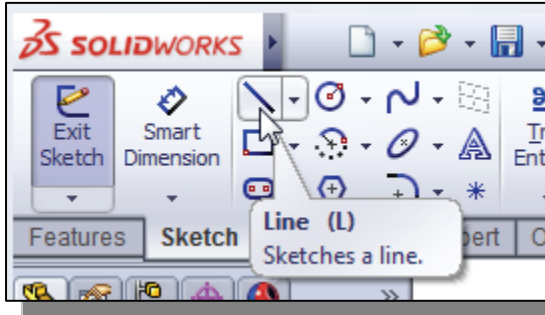

1. Move the graphics cursor to the **Line** icon in the *Sketch* toolbar. A *Help tip* box appears next to the cursor and a brief description of the command is displayed at the bottom of the drawing screen: “*Sketches a line.*” Select the icon by clicking once with the **left-mouse-button**.

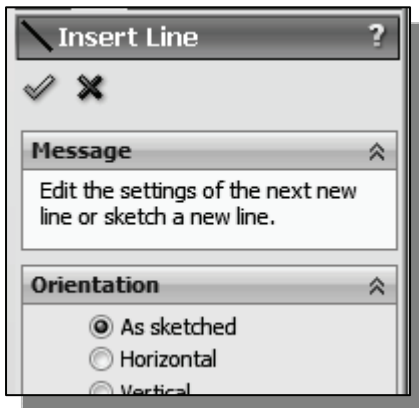

- Note the *Insert Line Feature Manager* is displayed in the left panel with different options related to the active command.

## Graphics Cursors

- Notice the cursor changes from an arrow to a pencil when graphical input is expected.

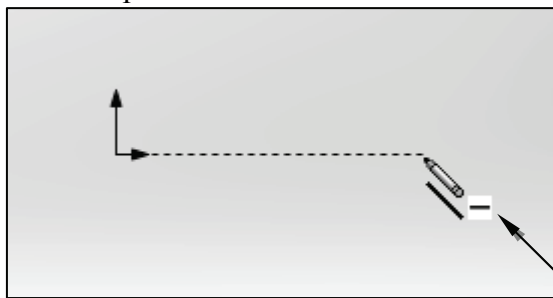



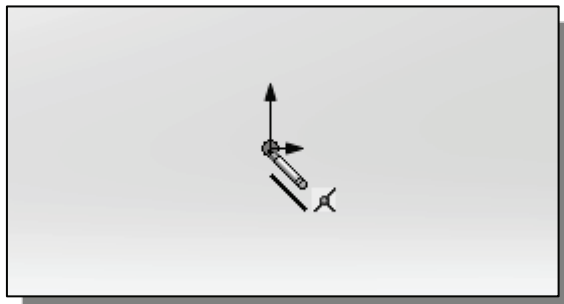



1. Move the cursor around and you will notice different symbols appear at different locations. As you move the graphics cursor, you will see a digital readout in the *Status Bar* area at the bottom of the window.

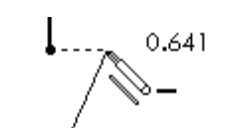

2. Move the cursor on top of the *Origin*, the little coordinate system near the center of the graphics area, and notice the constraint symbol as shown.

## Geometric Relation Symbols

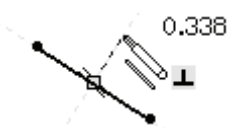
*SolidWorks* displays different visual clues, or symbols, to show you alignments, perpendicularities, tangencies, etc. These relations are used to capture the *design intent* by creating relations where they are recognized. *SolidWorks* displays the governing geometric rules as models are built. To prevent relations from forming, hold down the [Ctrl] key while creating an individual sketch curve. For example, while sketching line segments with the Line command, endpoints are joined with a **Coincident** relation, but when the [Ctrl] key is pressed and held, the inferred relation will not be created.

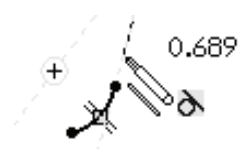
	<b>Vertical</b>	indicates a line is vertical
	<b>Horizontal</b>	indicates a line is horizontal
	<b>Dashed line</b>	indicates the alignment is to the center point or endpoint of an entity
	<b>Parallel</b>	indicates a line is parallel to other entities
	<b>Perpendicular</b>	indicates a line is perpendicular to other entities
	<b>Coincident</b>	indicates the endpoint will be coincident with another entity
	<b>Concentric</b>	indicates the cursor is at the center of an entity
	<b>Tangent</b>	indicates the cursor is at tangency points to curves

1. Create the sketch as shown below, starting at the *Origin*, and create a closed region ending at the starting point (**Point 1**). Do not be overly concerned with the actual size of the sketch. Note that the **four inclined lines** are sketched **not perpendicular or parallel** to each other.

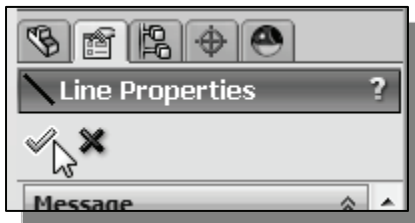
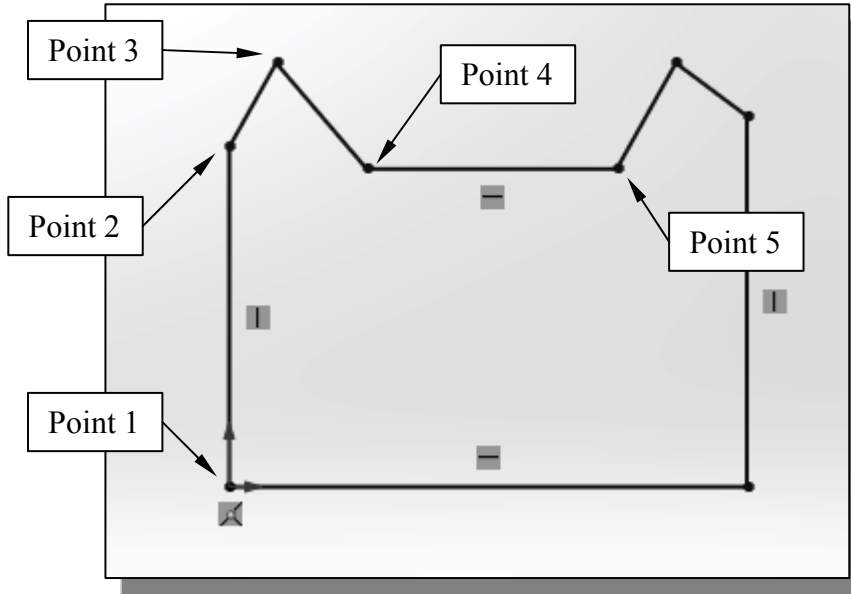

2. Click the **OK** icon (green check mark) in the *Property Manager* to end editing of the current line, then click the **OK** icon again to end the Sketch Line command, or hit the **[Esc]** key once to end the Sketch Line command.

### Step 3: Apply/Modify Constraints and Dimensions

- As the sketch is made, *SolidWorks* automatically applies some of the geometric constraints (such as horizontal, parallel, and perpendicular) to the sketched geometry. We can continue to modify the geometry, apply additional constraints, and/or define the size of the existing geometry. In this example, we will illustrate adding dimensions to describe the sketched entities.

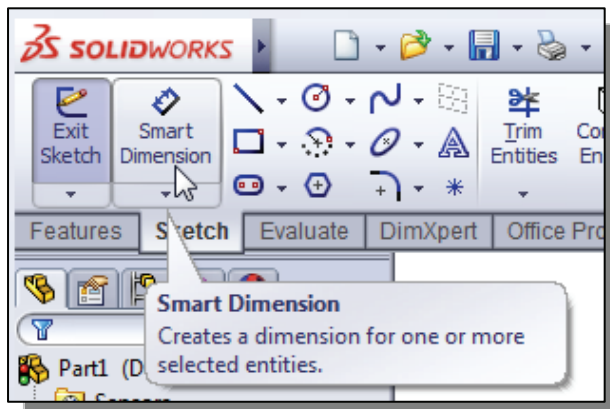

1. Move the cursor to the second icon of the *Sketch* toolbar; it is the **Smart Dimension** icon. Activate the command by left-clicking once on the icon.

2. Select the left vertical line by left-clicking once on the line.

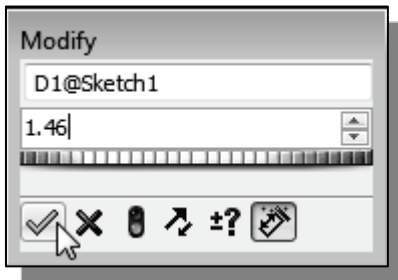
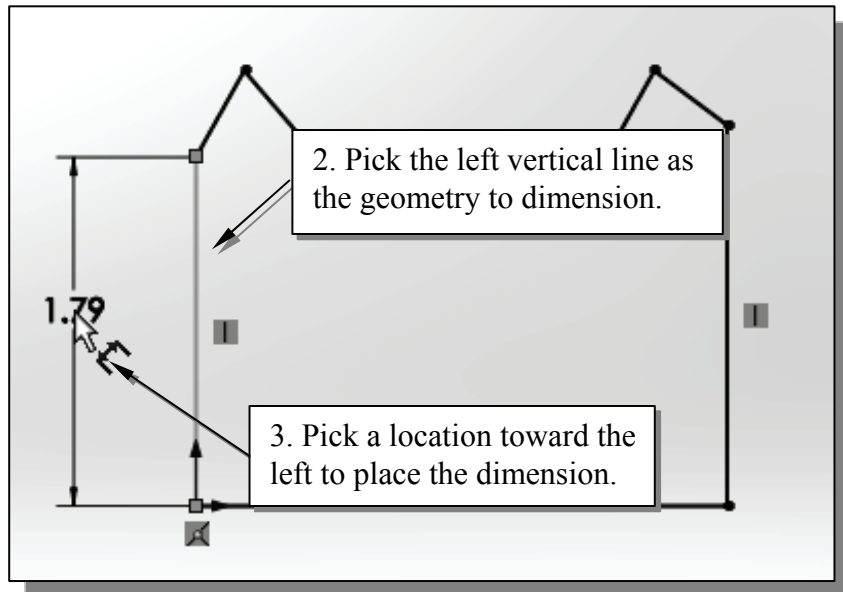

3. Enter **1.46** in the *Modify* dialog box.
4. Left-click **OK** (green check mark) in the *Modify* dialog box to save the current value and exit the dialog. Notice the associated geometry is adjusted.

5. On your own, repeat the above steps and create another length dimension on the right as shown.

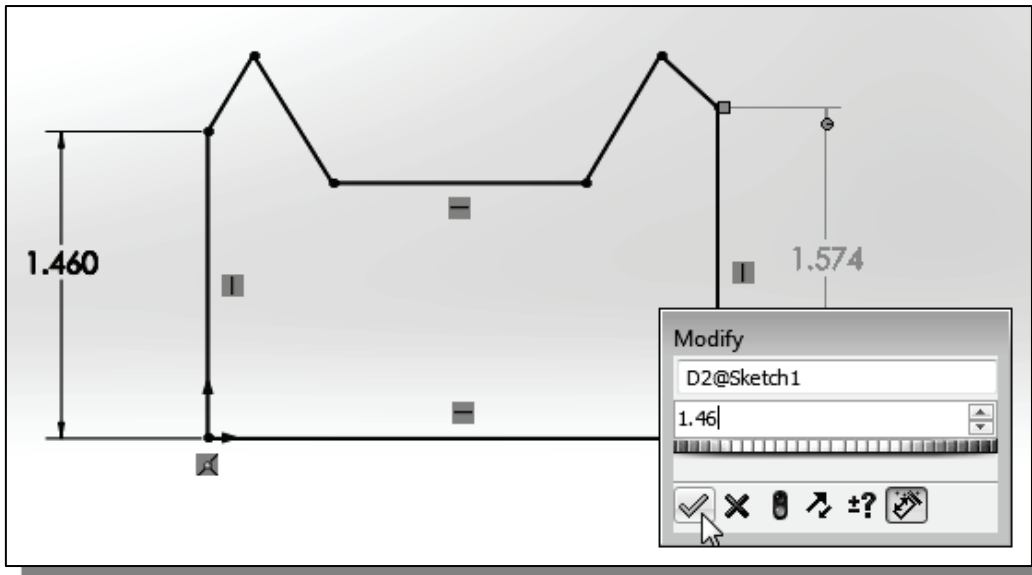

- ❖ The Smart Dimension command will create a length dimension if a single line is selected.

6. Select the left-vertical line as shown below.
7. Select the right-vertical line as shown below.

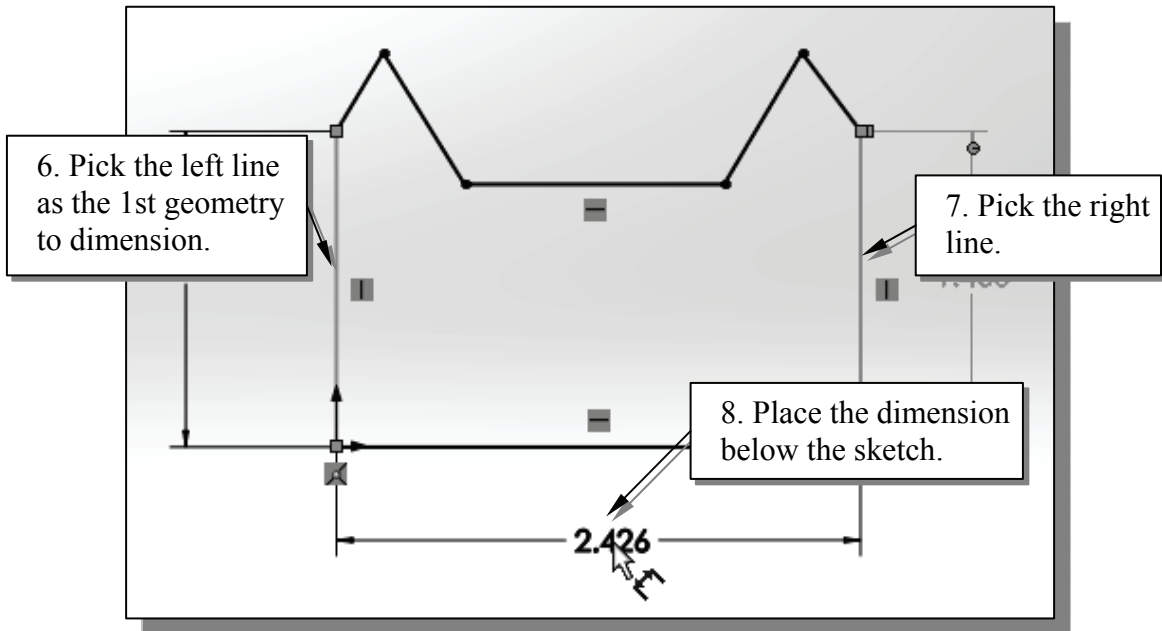

8. Pick a location below the sketch to place the dimension.

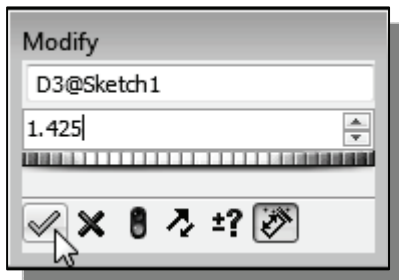

9. Enter **1.425** in the *Modify* dialog box.
10. Left-click **OK** (green check mark) in the *Modify* dialog box to save the current value and exit the dialog.

- Notice the sketch is adjusted, but the shape is twisted since several dimensions are still needed to fully define the sketch.

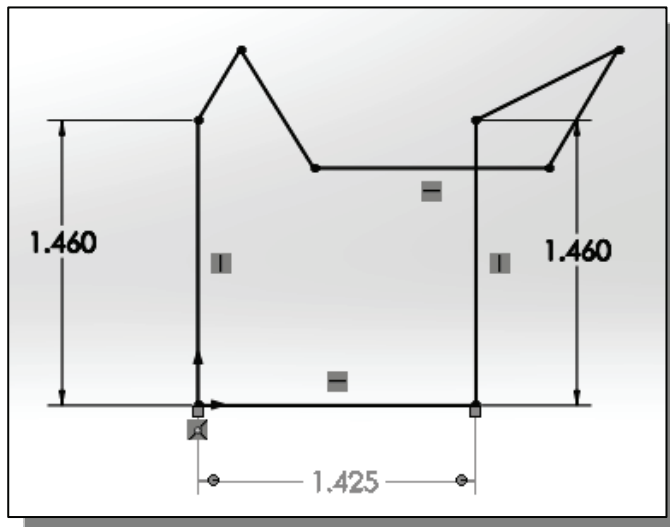

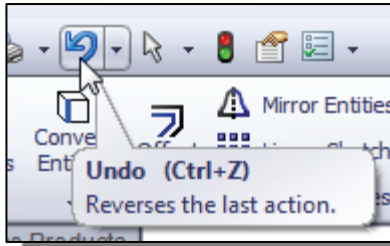

11. Click **Undo** in the *Quick Access Menu* as shown.

- In parametric modeling, it may be necessary to delay the adjustment of some dimensions.

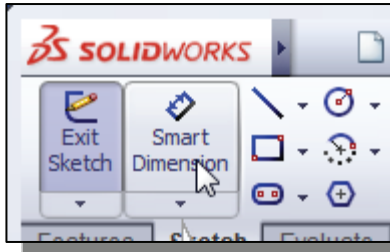

12. Activate the **Smart Dimension** command by left-clicking once on the icon.

13. Select the top left corner as shown.

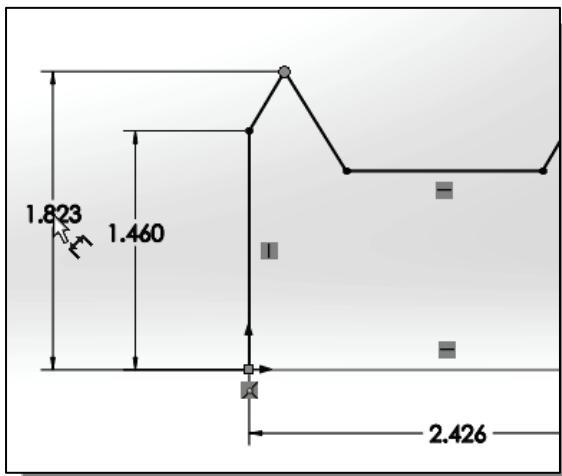
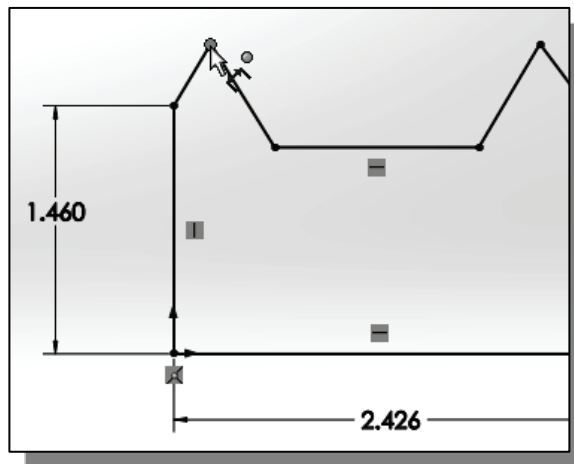

14. Select the bottom horizontal line as the 2<sup>nd</sup> geometry to dimension.

15. Place the dimension toward the left of the sketch as shown.

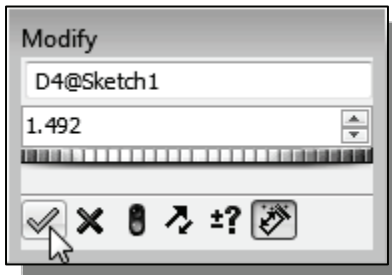

16. Enter **1.492** in the *Modify* dialog box.

17. Left-click **OK** (green check mark) in the *Modify* dialog box to save the current value and exit the dialog.



18. Select the left vertical line as shown.

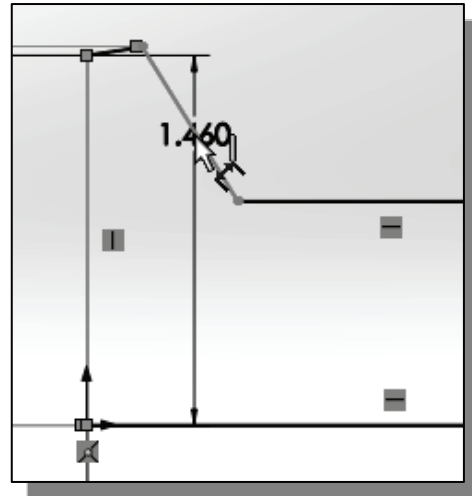
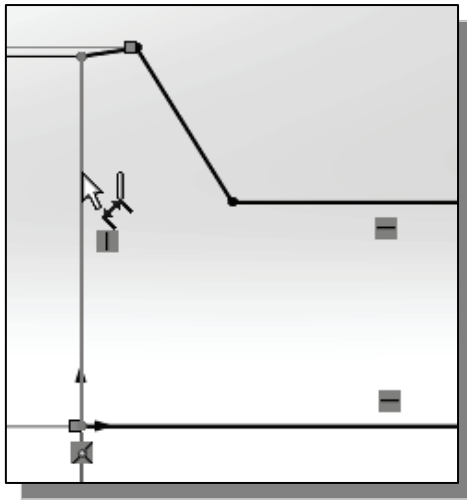

19. Select the longer inclined line on the left as the 2<sup>nd</sup> geometry to dimension.

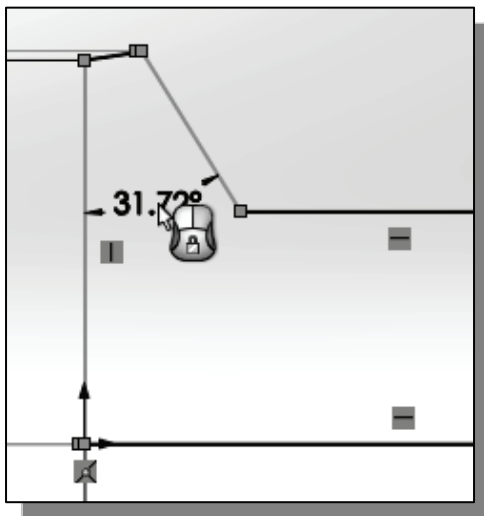

20. Place the angular dimension in the middle of the two selected lines as shown.

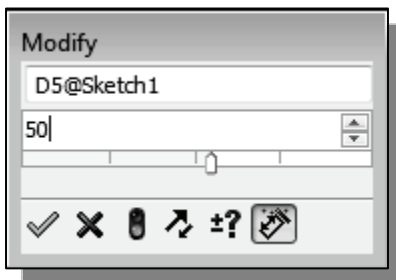

21. Enter **50** in the *Modify* dialog box.

22. Left-click **OK** (green check mark) in the *Modify* dialog box to save the current value and exit the dialog.

❖ Based on the selected entities, the Smart Dimension command will create associated dimensions; this is also known as **Smart dimensioning** in *parametric modeling*.

23. On your own, repeat the above steps and create additional dimensions so that the sketch appears as shown.

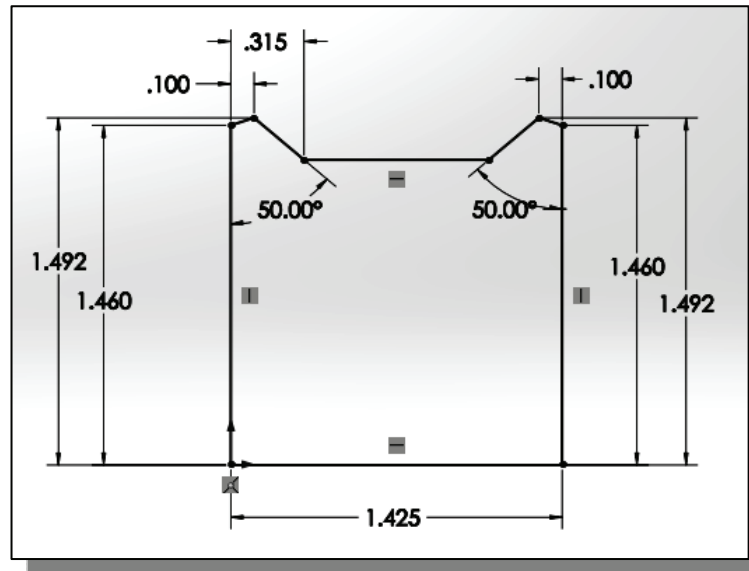

## Viewing Functions – Zoom and Pan

- *SolidWorks* provides a special user interface that enables convenient viewing of the entities in the graphics window. There are many ways to perform the **Zoom** and **Pan** operations.
1. Hold the [**Ctrl**] function key down. While holding the [**Ctrl**] function key down, press the mouse wheel down and drag the mouse to **Pan** the display. This allows you to reposition the display while maintaining the same scale factor of the display.
  2. Hold the [**Shift**] function key down. While holding the [**Shift**] function key down, press the mouse wheel down and drag the mouse to **Zoom** the display. Moving downward will reduce the scale of the display, making the entities display smaller on the screen. Moving upward will magnify the scale of the display.
  3. Turning the mouse wheel can also adjust the scale of the display. Turn the mouse wheel forward. Notice the scale of the display is reduced, making the entities display smaller on the screen.
  4. Turn the mouse wheel backward. Notice scale of the display is magnified. (**NOTE:** Turning the mouse wheel allows zooming to the position of the cursor.)
  5. On your own, use the options above to change the scale and position of the display.
  6. Press the **F** key on the keyboard to automatically fit the model to the screen.

## Delete an Existing Geometry of the Sketch

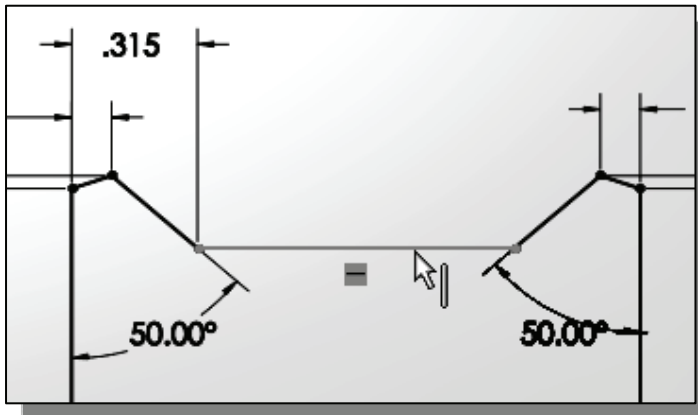

1. Select the top horizontal line by **left-clicking** once on the line.

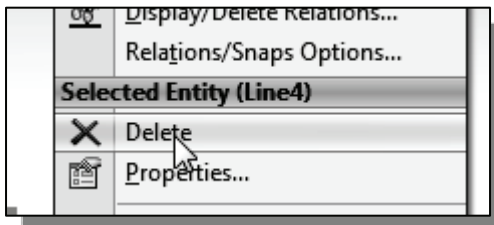

2. Click once with the right-mouse-button to bring up the **option menu**.
3. Select **Delete** from the option list as shown.

➤ Note that any dimension attached to the geometry will be also deleted.

## Using the 3-Point Arc command

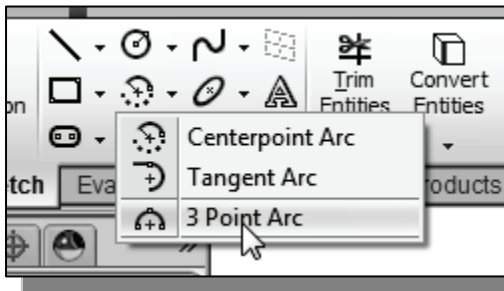

1. Select the **Three Point Arc** command in the *Sketch* toolbar as shown.

➤ Note the **Three Point Arc** command requires defining the end point locations first.

2. Select the **left endpoint** of the long inclined line on the left as shown.

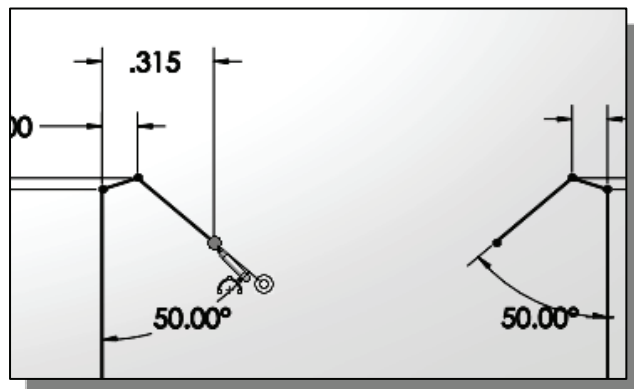

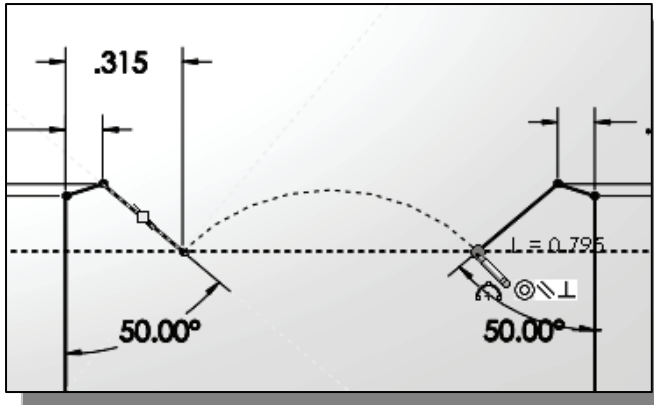

3. Select the endpoint of the longer inclined line on the right as shown.

4. Move the cursor above the two selected points to set the curvature of the arc, **left-clicking** once when the radius is roughly 0.9 inch as shown.

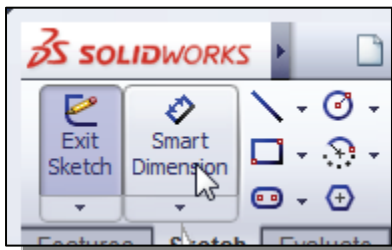
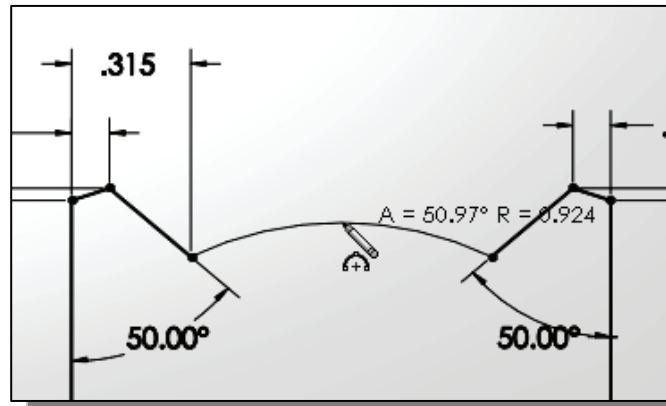

5. Activate the **Smart Dimension** command by left-clicking once on the icon.

6. Select the arc we just created, and enter **0.91** as the radius dimension as shown.
7. Also create the horizontal location dimension, **0.7125**, for the arc center as shown.

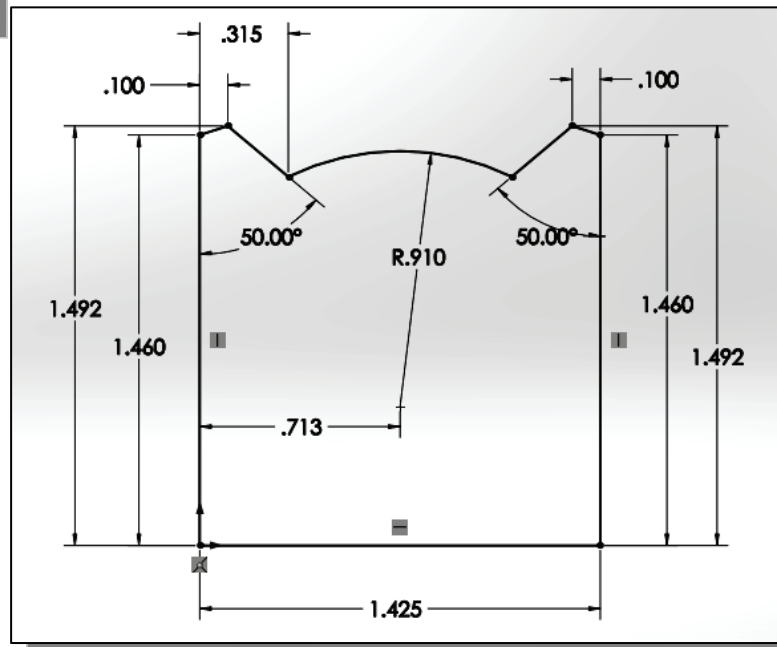

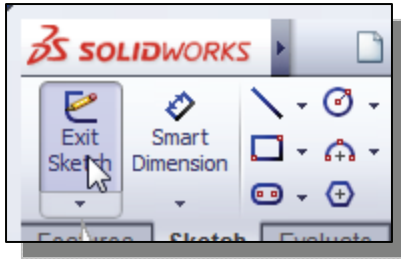

8. Click **Exit Sketch** in the *Sketch* toolbar to end the Sketch mode.

#### Step 4: Completing the Base Solid Feature

Now that the 2D sketch is completed, we will proceed to the next step: creating a 3D part from the 2D profile. Extruding a 2D profile is one of the common methods that can be used to create 3D parts. We can extrude planar faces along a path. We can also specify a height value and a tapered angle. In *SolidWorks*, each face has a positive side and a negative side, the current face we're working on is set as the default positive side. This positive side identifies the positive extrusion direction and it is referred to as the face's *normal*.

1. In the *Extrude Property Manager*, enter **0.1** as the extrusion distance. Notice that the completed sketch region is automatically selected as the extrusion profile.

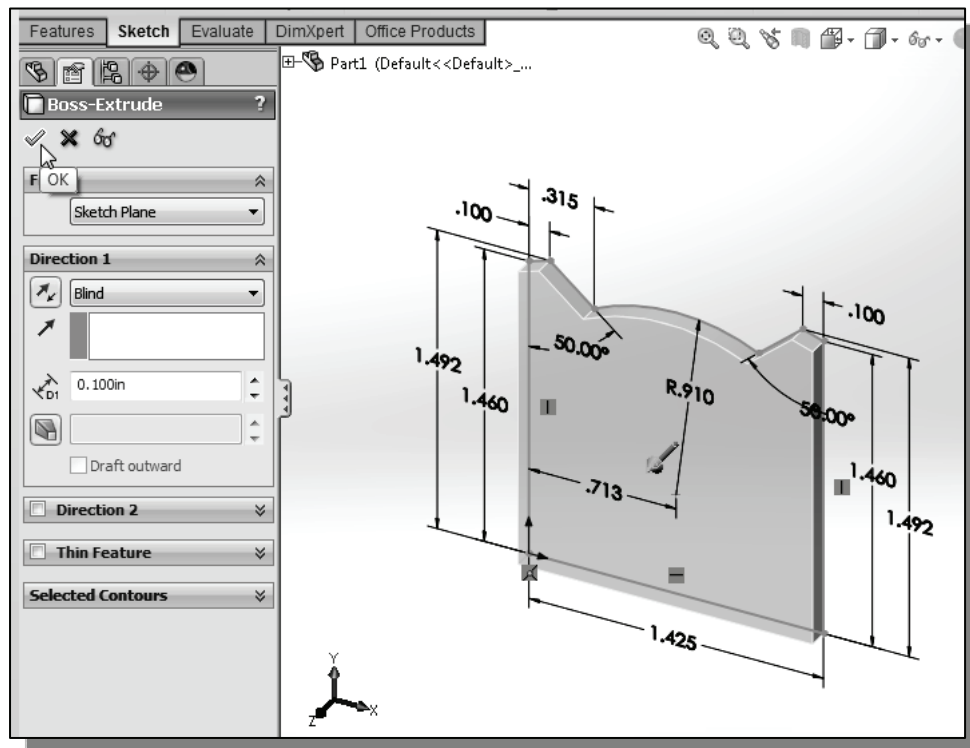

2. Click on the **OK** button to proceed with creating the 3D part.
- Note that all dimensions disappeared from the screen. All parametric definitions are stored in the *SolidWorks* database and any of the parametric definitions can be re-displayed and edited at any time.

## Isometric View

- ❖ *SolidWorks* provides many ways to display views of the three-dimensional design. We will first orient the model to display in the *isometric view*, by using the *View Orientation* pull-down menu on the *Heads-up View* toolbar.

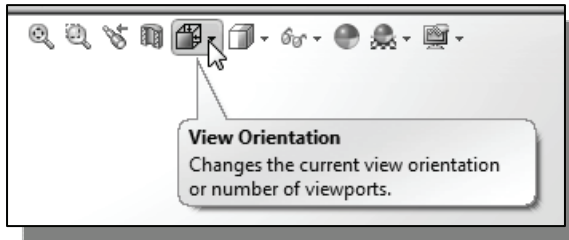

1. Select the **View Orientation** button on the *Heads-up View* toolbar by clicking once with the left-mouse-button.

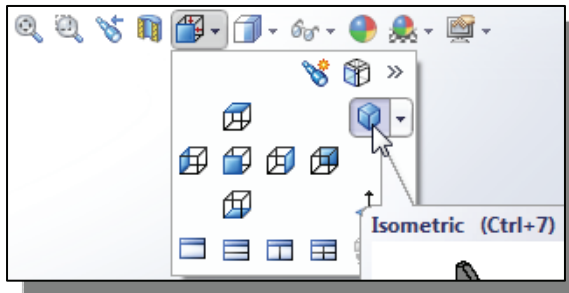

2. Select the **Isometric** icon in the *View Orientation* pull-down menu.
- ❖ Note that many other view-related commands are also available under the **View** pull-down menu.

## Rotation of the 3D Model – Rotate View

The Rotate View command allows us to rotate a part or assembly in the graphics window. Rotation can be around the center mark, free in all directions, or around a selected entity (vertex, edge, or face) on the model.

1. Move the cursor over the **SolidWorks** logo to display the pull-down menus. Select **View** → **Modify** → **Rotate** from the pull-down menu as shown.

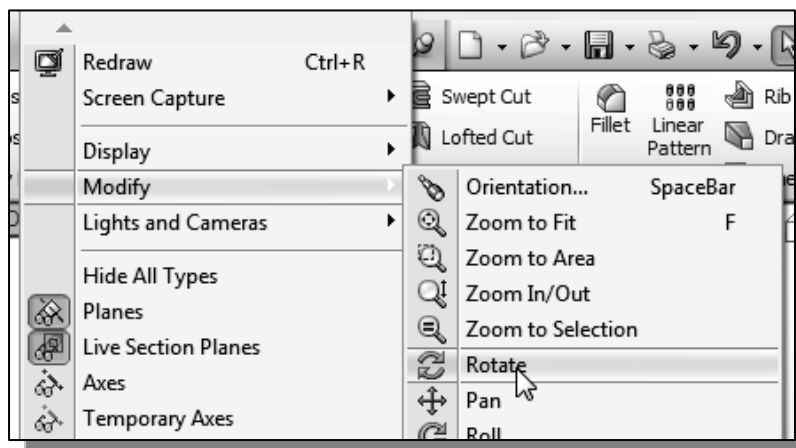

2. Move the cursor inside the graphics area. Press down the left-mouse-button and drag in an arbitrary direction; the Rotate View command allows us to freely rotate the solid model.

- The model will rotate about an axis normal to the direction of cursor movement. For example, drag the cursor horizontally across the screen and the model will rotate about a vertical axis.

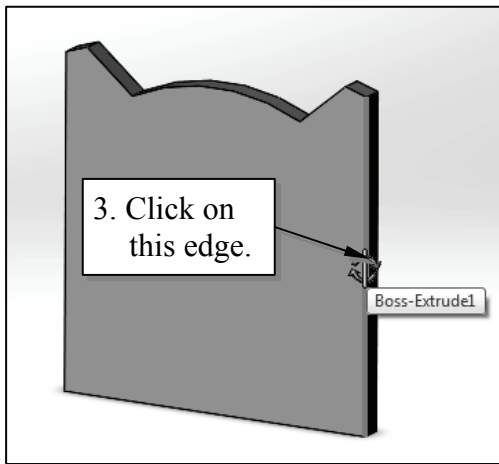

3. Move the cursor over one of the vertical edges of the solid model as shown. When the edge is highlighted, click the **left-mouse-button** once to select the edge.
4. Press down the left-mouse-button and drag. The model will rotate about this edge.
5. Left-click in the graphics area, outside the model, to unselect the edge.

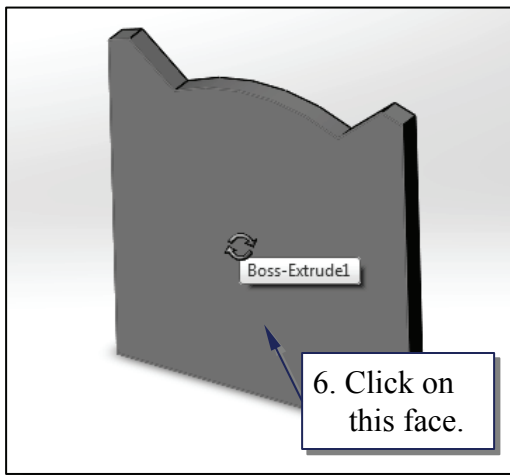

6. Move the cursor over the front face of the solid model as shown. When the face is highlighted, click the **left-mouse-button** once to select the face.
7. Press down the left-mouse-button and drag. The model will rotate about the direction normal to this face.
8. Left-click in the graphics area, outside the model, to unselect the face.



9. Move the cursor over one of the vertices as shown. When the vertex is highlighted, click the left-mouse-button once to select the vertex.
10. Press down the left-mouse-button and drag. The model will rotate about the vertex.
11. Left-click in the graphics area, outside the model, to unselect the vertex.

12. Press the [**Esc**] key once to exit the **Rotate View** command.

13. On your own, reset the display to the *isometric* view.

## Rotation and Panning – Arrow Keys

- *SolidWorks* allows us to easily rotate a part or assembly in the graphics window using the **arrow** keys on the keyboard.
- Use the **arrow** keys to rotate the view horizontally or vertically. The **left-right** keys rotate the model about a vertical axis. The **up-down** keys rotate the model about a horizontal axis.
- Hold down the [**Alt**] key and use the **left-right arrow** keys to rotate the model about an axis normal to the screen, i.e., to rotate clockwise and counter-clockwise.

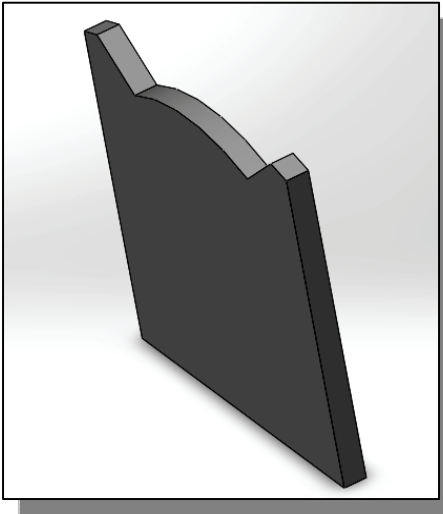

1. Hit the **left arrow** key. The model view rotates by a pre-determined increment. The default increment is  $15^\circ$ . (This increment can be set in the *Options* dialog box.) On your own, use the **left-right** and **up-down** arrow keys to rotate the view.
2. Hold down the [**Alt**] key and hit the **left arrow** key. The model view rotates in the clockwise direction. On your own use the **left-right** and **up-down** arrow keys, and the [**Alt**] key plus the **left-right** arrow keys, to rotate the view.
3. On your own, reset the display to the *isometric* view.
  - Hold down the [**Shift**] key and use the **left-right** and **up-down** arrow keys to rotate the model in  $90^\circ$  increments.
4. Hold down the [**Shift**] key and hit the **right arrow** key. The view will rotate by  $90^\circ$ . On your own use the [**Shift**] key plus the **left-right** arrow keys to rotate the view.
5. Select the **Front** icon in the *View Orientation* pull-down menu as shown to display the **Front** view of the model.

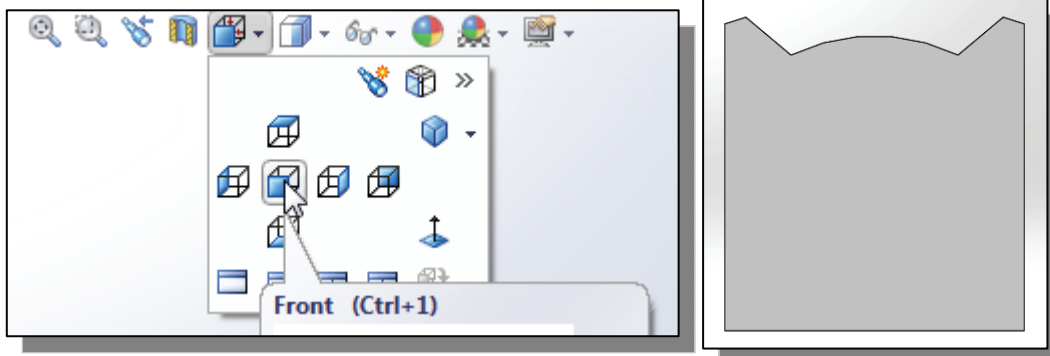



6. Hold down the [**Shift**] key and hit the **left arrow** key. The view rotates to the **Right side view**.
7. Hold down the [**Shift**] key and hit the **down arrow** key. The view rotates to the **Top view**.

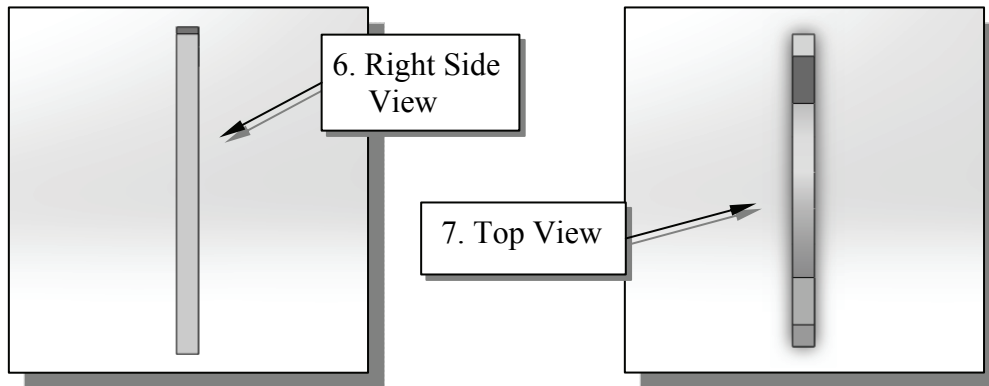

8. On your own, reset the display to the **Isometric** view.
  - Hold down the [**Ctrl**] key and use the left-right and up-down arrow keys to **Pan** the model in increments.
9. Hold down the [**Ctrl**] key and hit the **left arrow** key. The view **Pans**, moving the model toward the left side of the screen. On your own use [**Ctrl**] key plus the left-right and up-down arrow keys to **Pan** the view.

## Dynamic Viewing – Quick Keys

We can also use the function keys on the keyboard and the mouse to access the *Dynamic Viewing* functions.

### ❖ Panning

#### (1) Hold the **Ctrl** key; press and drag the mouse wheel

Hold the [**Ctrl**] function key down, and press and drag with the mouse wheel to **Pan** the display. This allows you to reposition the display while maintaining the same scale factor of the display.

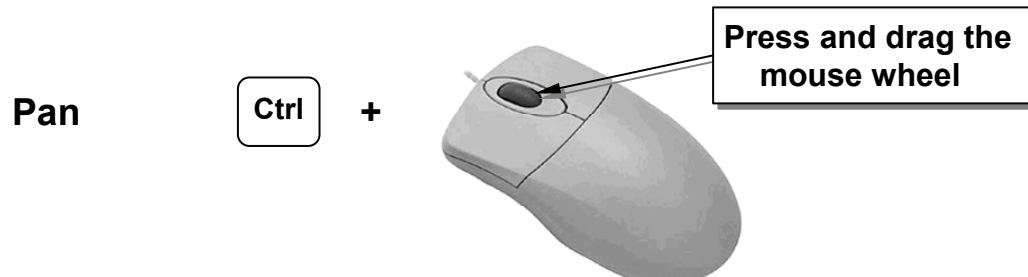

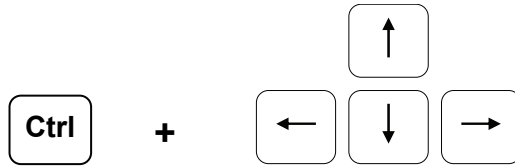
**(2) Hold the Ctrl key; use arrow keys****❖ Zooming****(1) Hold the Shift key; press and drag the mouse wheel**

Hold the [**Shift**] function key down, and press and drag with the mouse wheel to **Zoom** the display. Moving downward will reduce the scale of the display, making the entities display smaller on the screen. Moving upward will magnify the scale of the display.

**(2) Turning the mouse wheel**

Turning the mouse wheel can also adjust the scale of the display. Turning forward will reduce the scale of the display, making the entities display smaller on the screen. Turning backward will magnify the scale of the display.

- Turning the mouse wheel allows zooming to the position of the cursor.
- The cursor position, inside the graphics area, is used to determine the center of the scale of the adjustment.

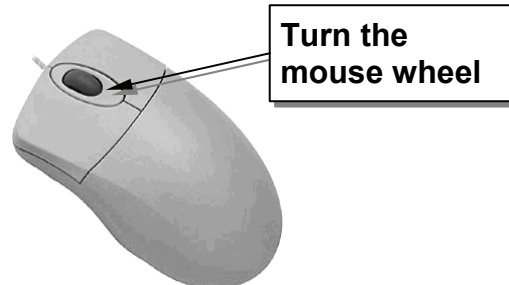
**(3) Z key or Shift + Z key**

Pressing the [**Z**] key on the keyboard will zoom out. Holding the [**Shift**] function key and pressing the [**Z**] key will zoom in.



### 3D Rotation

#### (1) Press and drag the mouse wheel

Press and drag with the mouse wheel to rotate the display.

#### Rotation

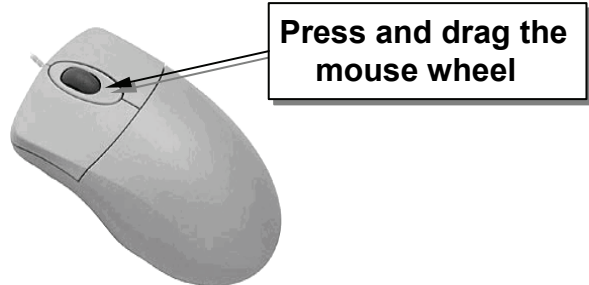

#### (2) Use arrow keys

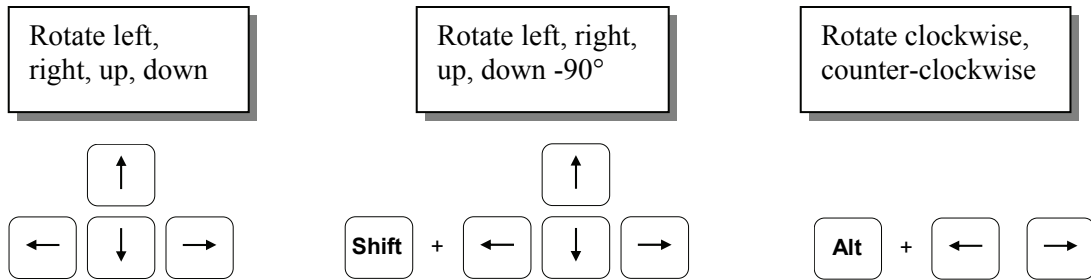

### Viewing Tools – Heads-up View Toolbar

The *Heads-up View* toolbar is a transparent toolbar which appears in each viewport and provides easy access to commonly used tools for manipulating the view. The default toolbar is described below.

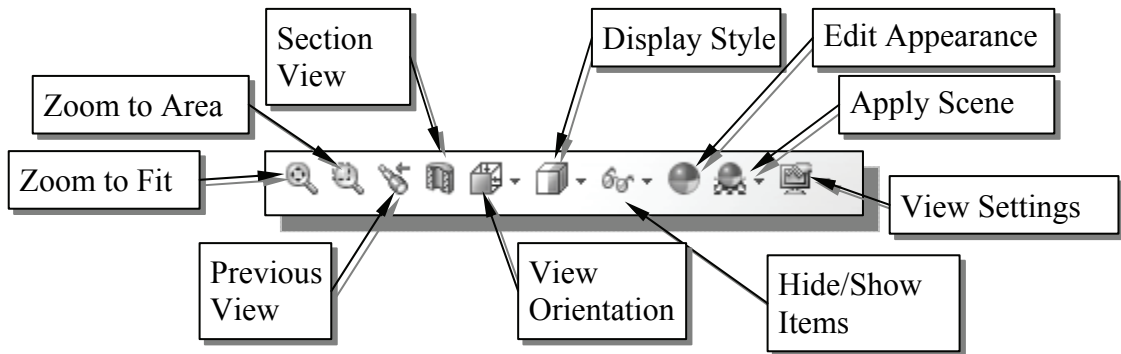

**Zoom to Fit** – Adjusts the view so that all items on the screen fit inside the graphics window.

**Zoom to Area** – Use the cursor to define a region for the view; the defined region is zoomed to fill the graphics window.

**Previous View** – Returns to the previous view.

**Section View** – Displays a cutaway of a part or assembly using one or more section planes.

**View Orientation** – This allows you to change the current view orientation or number of viewports.

**Display Style** – This can be used to change the display style (shaded, wireframe, etc.) for the active view.

**Hide/Show Items** – This pull-down menu is used to control the visibility of items (axes, sketches, relations, etc.) in the graphics area.

**Edit Appearance** – Modifies the appearance of entities in the model.

**Apply Scene** – Cycles through or applies a specific scene.

**View Settings** – Allows you to toggle various view settings (e.g., shadows, perspective).

## View Orientation

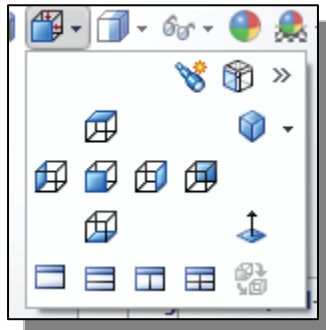

1. Click on the **View Orientation** icon on the *Heads-up View* toolbar to reveal the view orientation and number of viewports options.

Standard view orientation options – **Front, Back, Left, Right, Top, Bottom, Isometric, Trimetric** or **Dimetric** – icons can be selected to display the corresponding standard view. In the figure to the left, the **Isometric** view is selected.

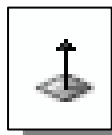

**Normal to** – In a part or assembly, zooms and rotates the model to display the selected plane or face. You can select the element either before or after clicking the **Normal to** icon.

- ❖ The icons across the bottom of the pull-down menu allow you to display a single viewport (the default) or multiple viewports.

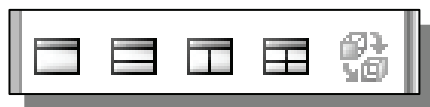

## Display Style

1. Click on the **Display Style** icon on the *Heads-up View* toolbar to reveal the display style options.



**Shaded with Edges** – Allows the display of a shaded view of a 3D model with its edges.

**Shaded** – Allows the display of a shaded view of a 3D model.

**Hidden Lines Removed** – Allows the display of the 3D objects using the basic wireframe representation scheme. Only those edges which are visible in the current view are displayed.

**Hidden Lines Visible** – Allows the display of the 3D objects using the basic wireframe representation scheme in which all the edges of the model are displayed, but edges that are hidden in the current view are displayed as dashed lines (or in a different color).

**Wireframe** – Allows the display of 3D objects using the basic wireframe representation scheme in which all the edges of the model are displayed.

## Orthographic vs. Perspective

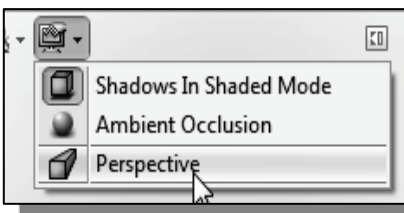

Besides the basic display modes, we can also choose an orthographic view or perspective view of the display. Clicking on the **View Settings** icon on the *Heads-up View* toolbar will reveal the **Perspective** icon. Clicking on the **Perspective** icon toggles the perspective view *ON* and *OFF*.

## Customizing the Heads-up View Toolbar

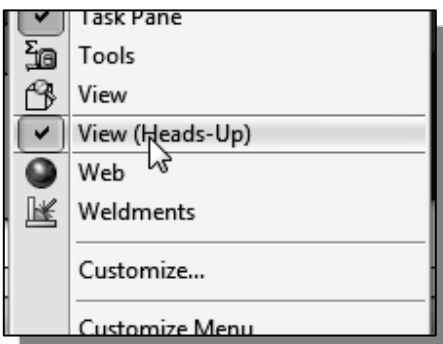

The *Heads-up View* toolbar can be customized to contain icons for user-preferred view options. **Right-click** anywhere on the *Heads-up View* toolbar to reveal the display menu option list. Click on the **View (Heads-up)** icon to turn *OFF* the display of the toolbar. Notice the **Customize** option is also available to add/remove different icons.

- On your own, use the different options described in the above sections to familiarize yourself with the 3D viewing/display commands. Reset the display to the standard **Isometric view** before continuing to the next section.

## Step 5-1: Adding an Extruded Feature

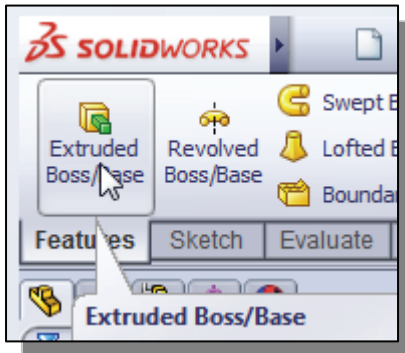

1. In the *Features* toolbar select the **Extruded Boss/Base** command by clicking once with the left-mouse-button on the icon.

- In the *Extrude Manager* area, *SolidWorks* indicates the two options to create the new extrusion feature. We will select the back surface of the base feature to align the sketching plane.

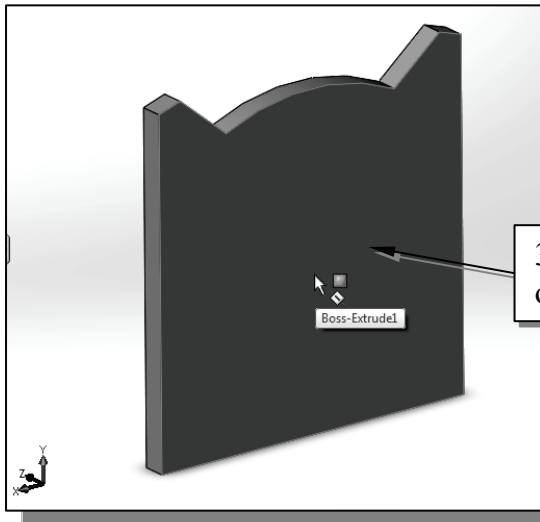
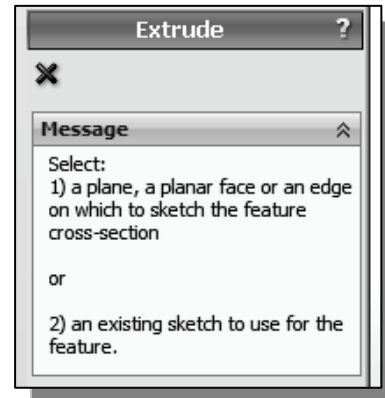

2. On your own, use one of the rotation quick keys/mouse-button and view the back face of the model as shown.
3. Pick the back face of the 3D solid object.

- Note that *SolidWorks* automatically establishes a *User Coordinate System* (UCS), and records its location with respect to the part on which it was created.

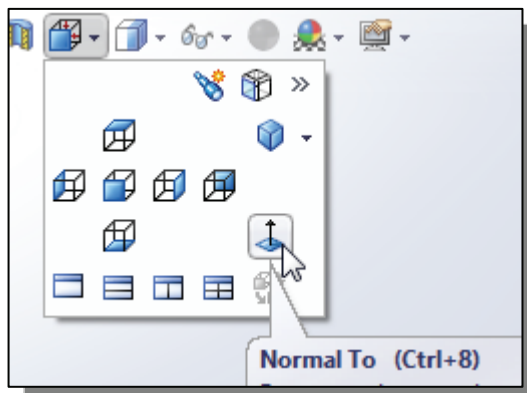

4. Adjust the display by using the **Normal To** option in the *View Orientation* panel as shown. (Quick Key: **Ctrl + S**)
- Next, we will create and profile another sketch, a rectangle, which will be used to create another extrusion feature that will be added to the existing solid object.

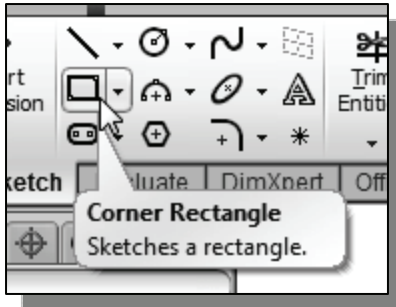

5. Select the **Corner Rectangle** command by clicking once with the **left-mouse-button** on the icon in the *Sketch* toolbar.

➤ To illustrate the usage of dimensions in parametric sketches, we will intentionally create a rectangle away from the desired location.

6. Create a sketch with segments perpendicular/parallel to the existing edges of the solid model as shown below.

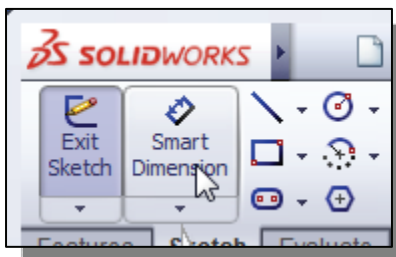
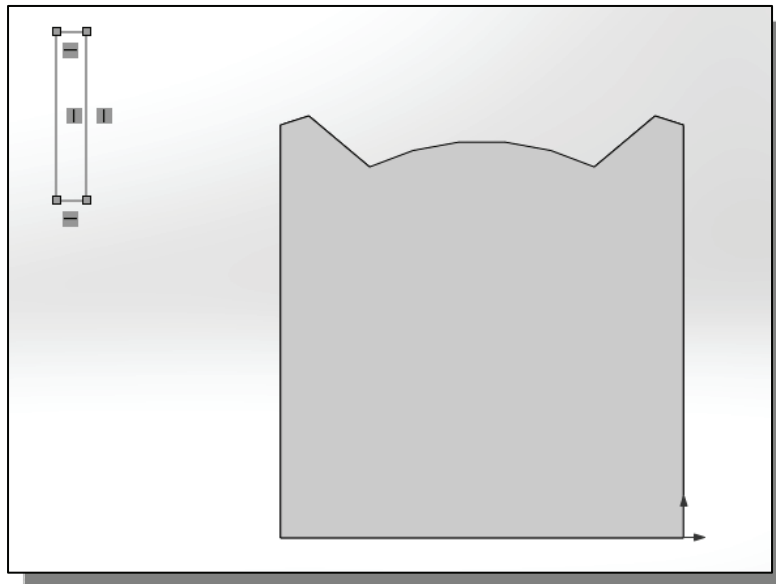

7. Select the **Smart Dimension** command in the *Sketch* toolbar. The **Smart Dimension** command allows us to quickly create and modify dimensions.

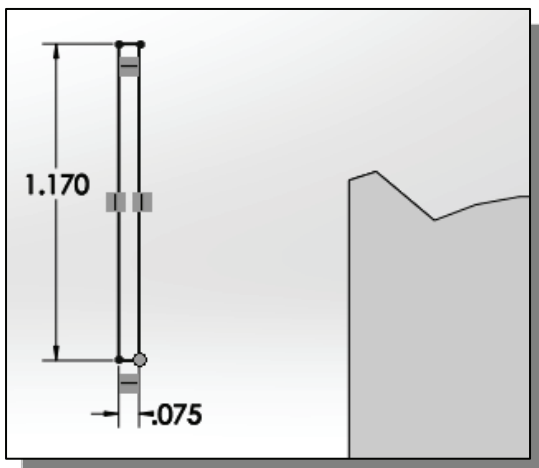

8. On your own, create and modify the size dimensions to describe the size of the sketch as shown in the figure.

9. Create the two location dimensions, accepting the default values, to describe the position of the sketch relative to the top corner of the solid model as shown.

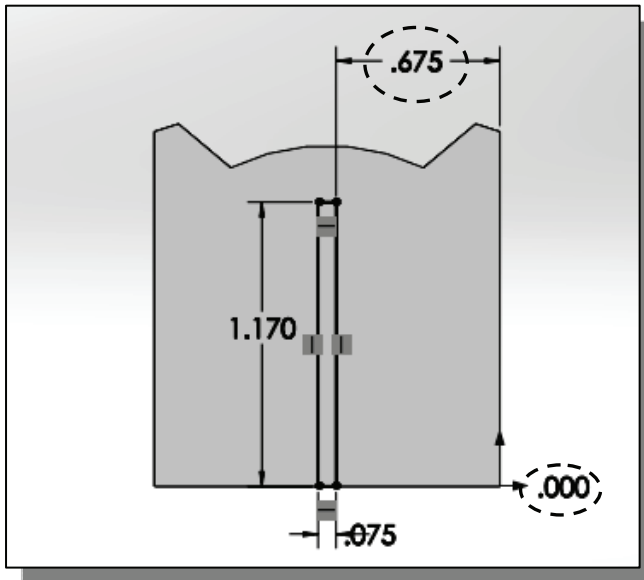
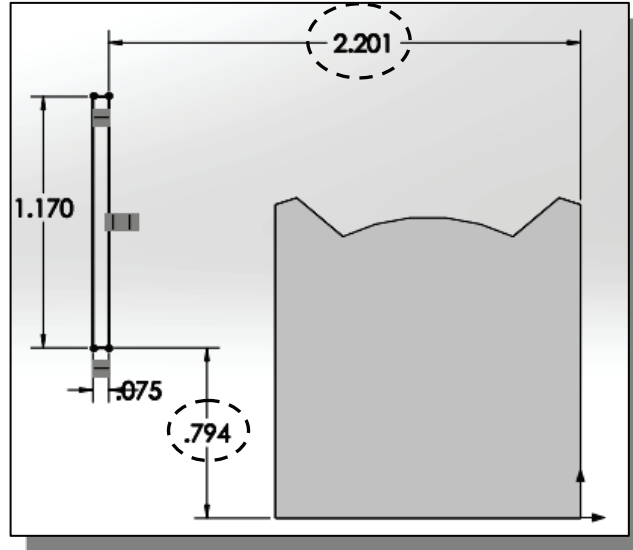

10. On your own, modify the location dimensions to **0.675** and **0.0** as shown in the figure.

➤ In parametric modeling, the dimensions can be used to quickly control the size and location of the defined geometry.

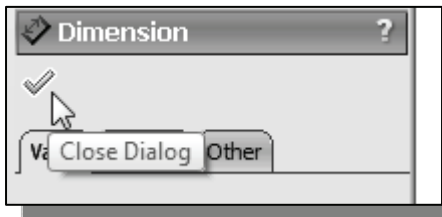

11. Select **Close Dialog** in the *Dimension Property Manager* to end the Smart Dimension command.

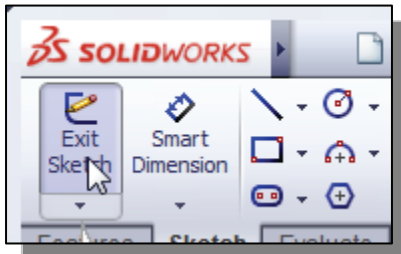

12. Click **Exit Sketch** in the *Sketch* toolbar to end the Sketch mode.



13. In the *Boss-Extrude Property Manager*, enter **0.45** as the extrude *Distance* as shown.

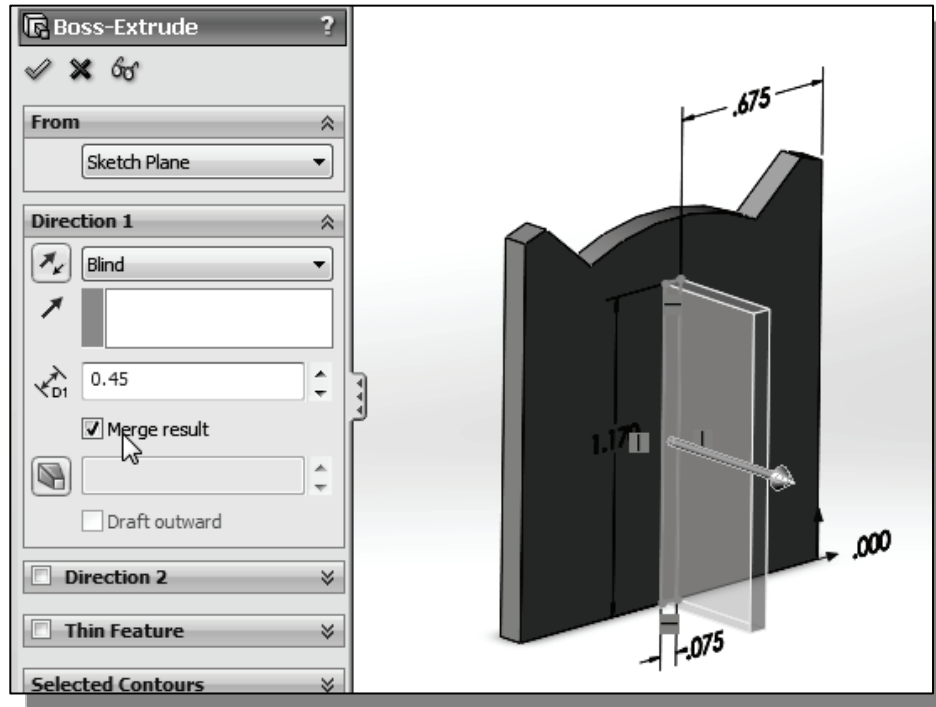

14. Confirm the **Merge result** option is activated as shown.

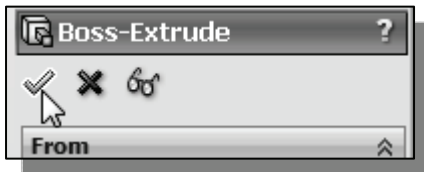

15. Click on the **OK** button to proceed with creating the extruded feature.

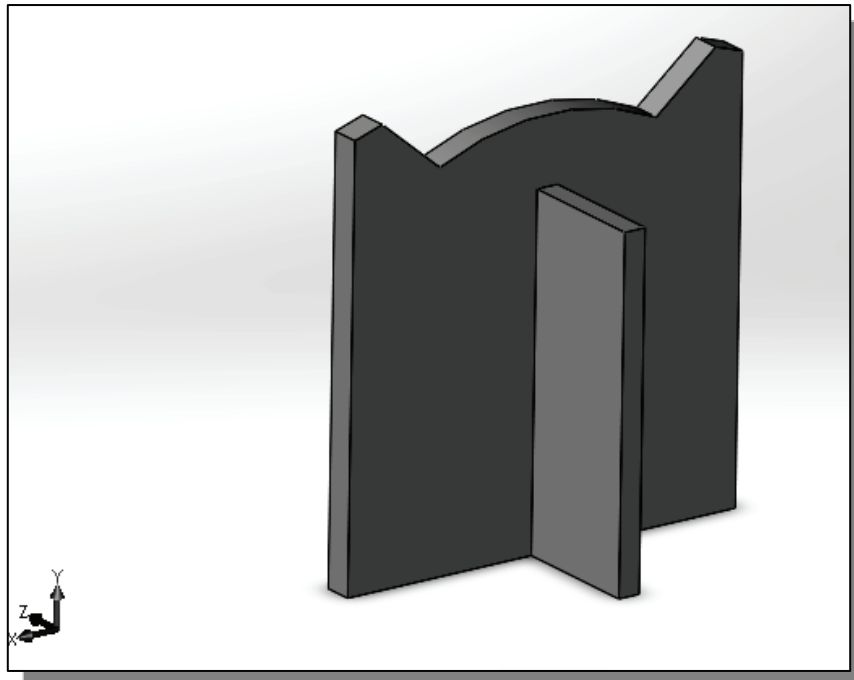

## Step 5-2: Adding a Cut Feature

- Next, we will create a **cut** feature that will be added to the existing solid object.

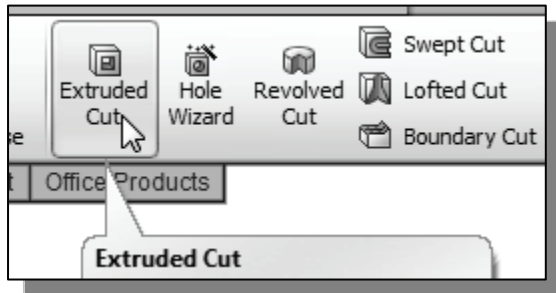

1. In the *Features* toolbar select the **Extruded Cut** command by clicking once with the left-mouse-button on the icon.

2. Pick the vertical face of the last feature we created, as shown.

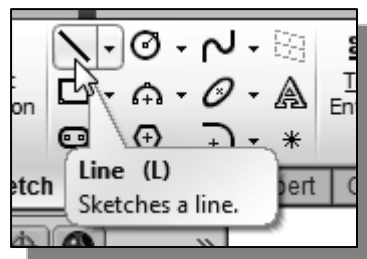
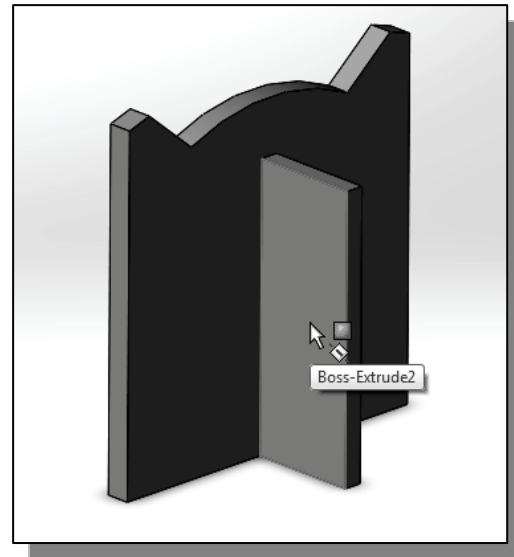

3. Select the **Line** command by clicking once with the left-mouse-button on the icon in the *Sketch* toolbar.

4. Create a closed region consisting of four line segments aligned to the upper right corner of the second solid feature as shown. (Hint: Start the line segments at the top corner.)

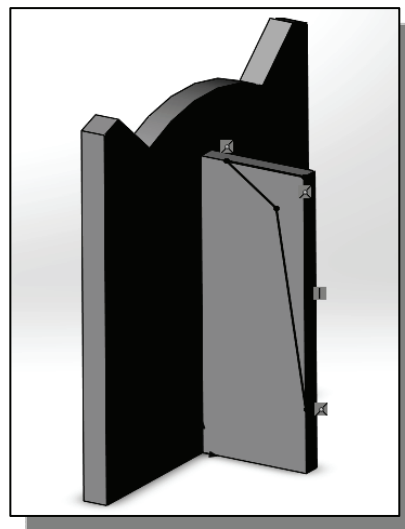

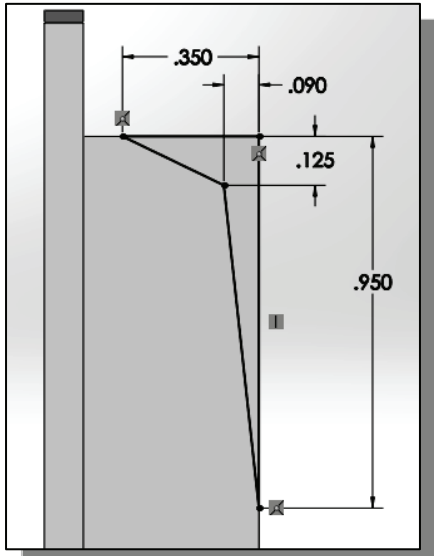

5. On your own, create and modify the dimensions of the sketch as shown in the figure.
6. Click **Exit Sketch** in the *Sketch* toolbar to end the Sketch mode.

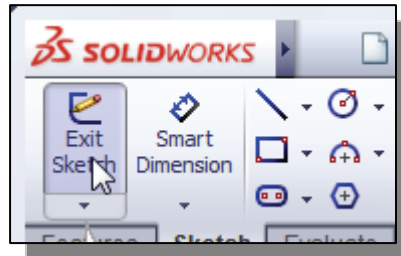

7. Set the *Extents* option to **Through All** as shown. The *Through All* option instructs the software to calculate the extrusion distance and assures the created feature will always cut through the full length of the model.

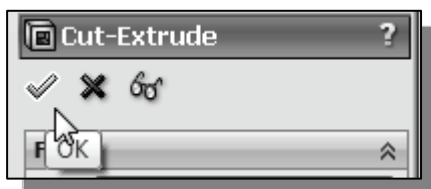
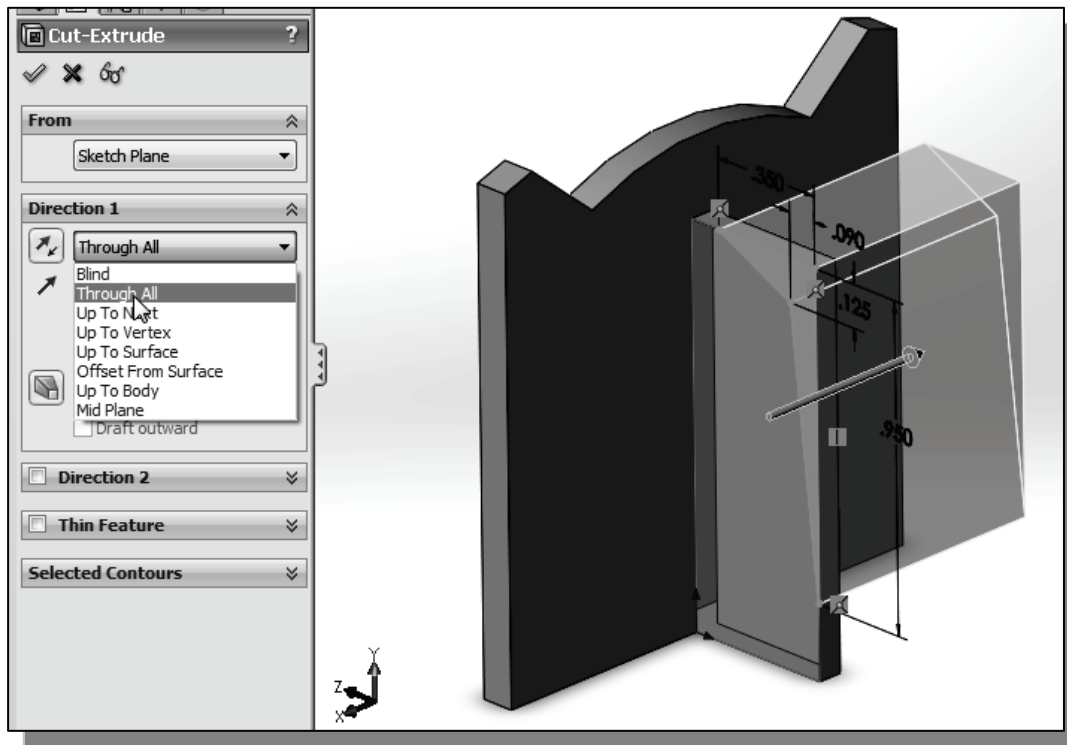

8. Click on the **OK** button to proceed with creating the extruded feature.

## Step 6: Adding Additional Features

- Next, we will create and profile another sketch, a circle, which will be used to create another extrusion feature that will be added to the existing solid object.

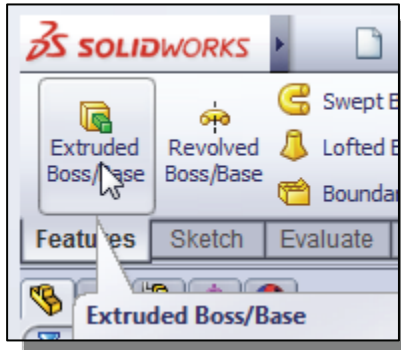

1. In the *Features* toolbar select the **Extruded Boss/Base** command by clicking once with the left-mouse-button on the icon.

2. Pick the bottom horizontal face of the 3D solid model as shown.

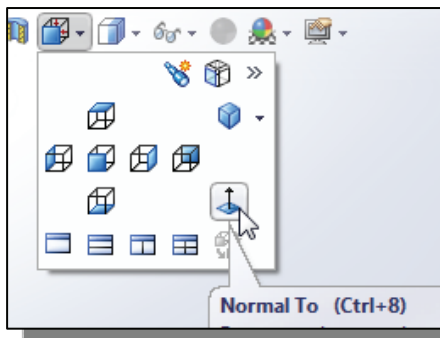
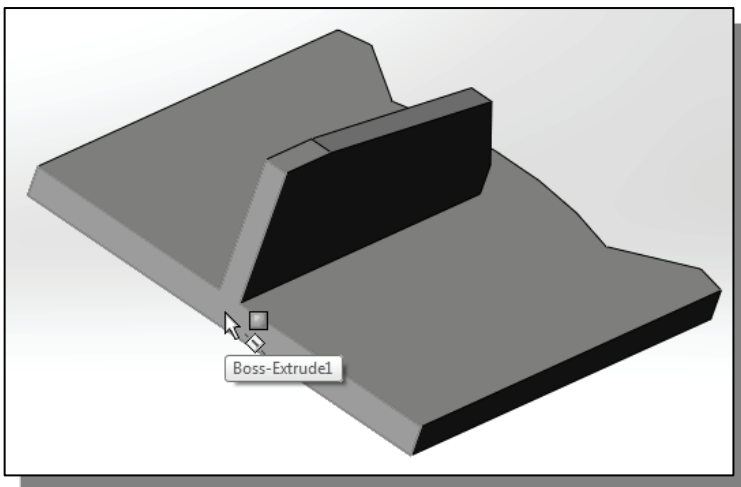

3. Adjust the display by using the **Normal To** option in the view orientation panel as shown.

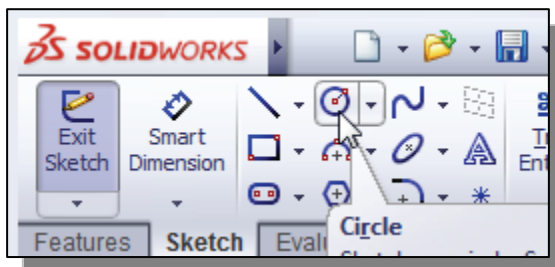

4. Select the **Circle** command by clicking once with the **left-mouse-button** on the icon in the *Sketch* toolbar.

5. Create a circle near the right edge of the bottom surface as shown.

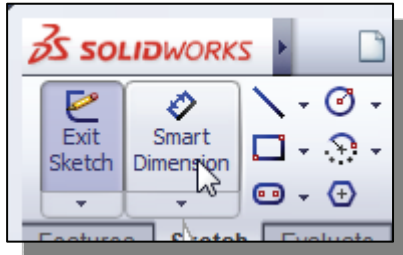
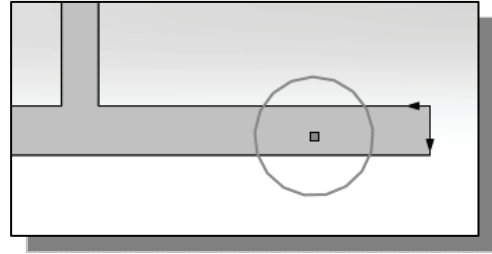

6. Select the **Smart Dimension** command in the *Sketch* toolbar. The Smart Dimension command allows us to quickly create and modify dimensions.

7. On your own, create and modify the three dimensions as shown.

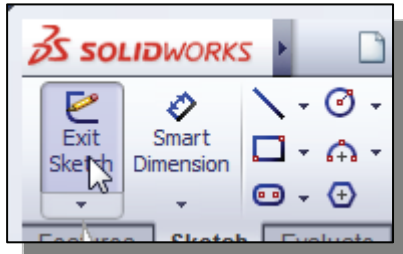
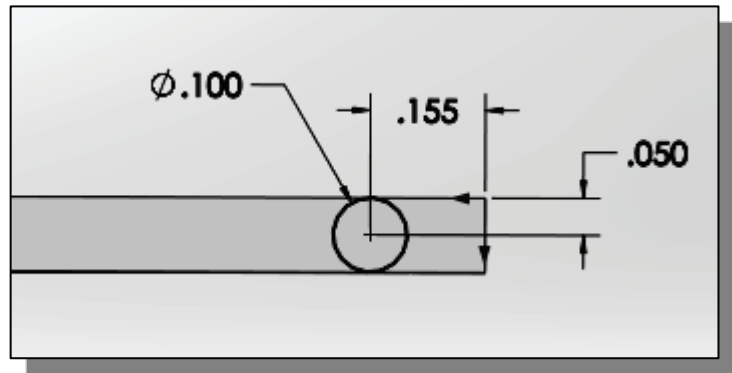

8. Click **Exit Sketch** in the *Sketch* toolbar to end the Sketch mode.

9. On your own, complete the **0.32** the extrusion as shown.

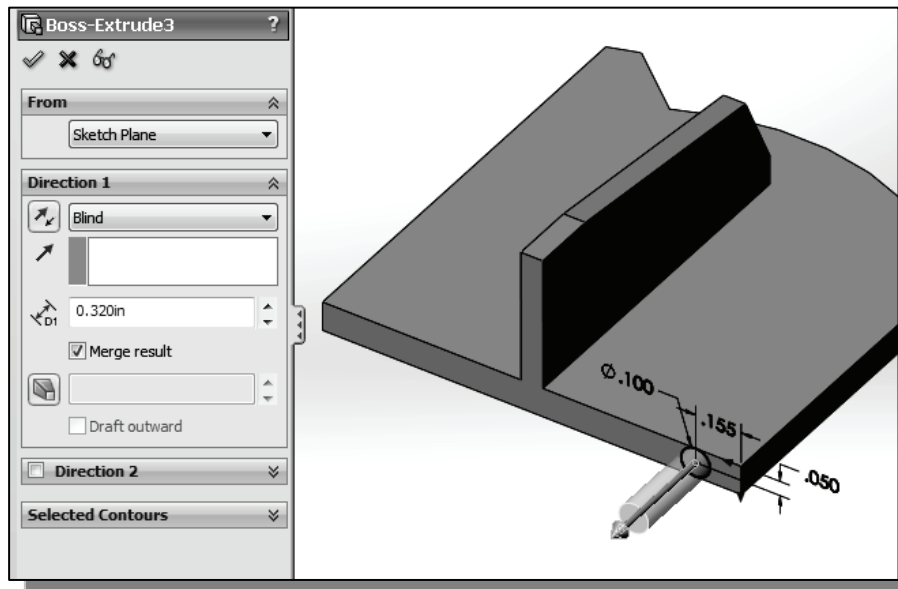

10. On your own, repeat the above steps and create another extruded feature on the other side.

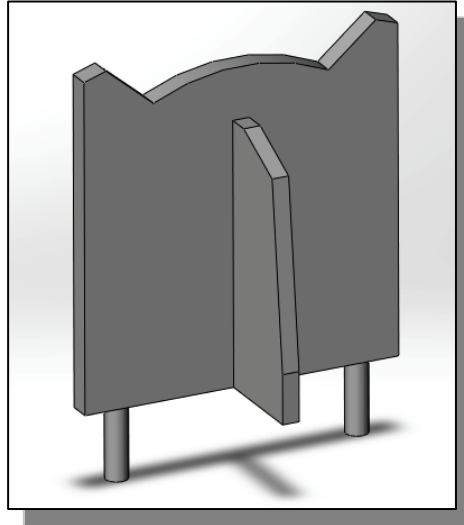
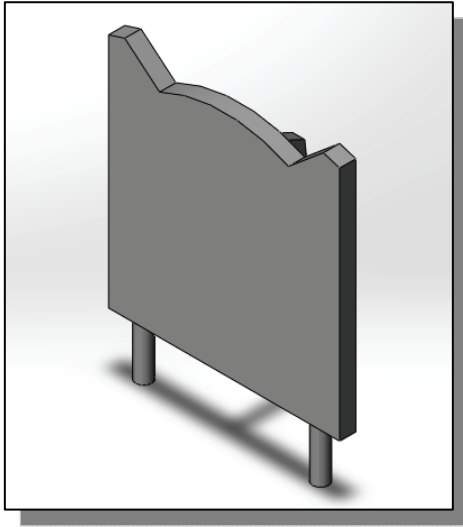

## Adding a Decal

- ❖ In *SolidWorks*, the **Decal** option can be used to apply a bitmap image on a surface to obtain a more realistic three-dimensional model.
1. Download the *TigerFace.bmp* file and save it to the *Mechanical-Tiger* project folder. (URL: <http://www.schroff.com/SolidWorks/TigerFace.bmp> )

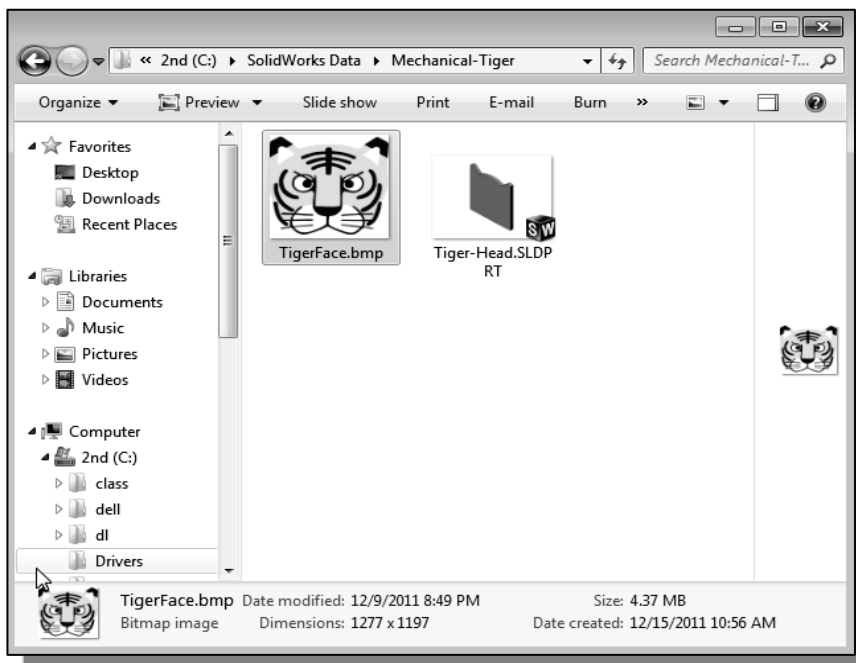

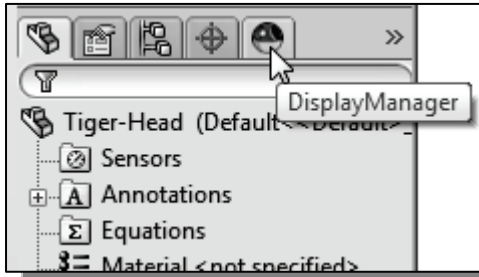

2. Activate the **Display Manager** by clicking on the associated tab as shown.

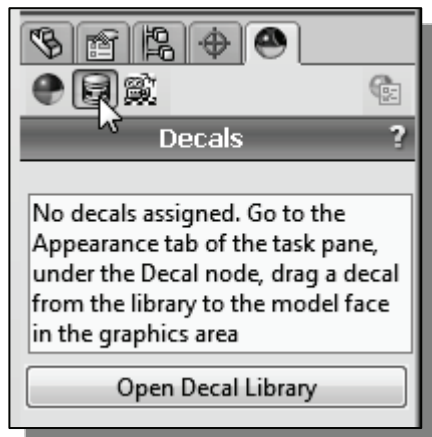

3. In the *Display Manager*, select the **Decals** command by left-clicking once on the icon.
4. Click on the **Open Decal Library** button to view the existing decals available.

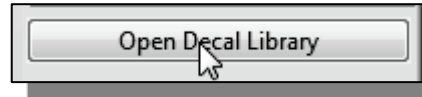

- In *SolidWorks*, a decal can be applied to a surface by **drag and drop** from the *Decal Library*.
5. Select one of the decals in the *Decal Library* and drag it to the front surface of the *Tiger* model as shown.

- Note that the selected decal is used to access the *Decal Editing Manager*, which will allow us to import the *TigerFace.bmp* file.

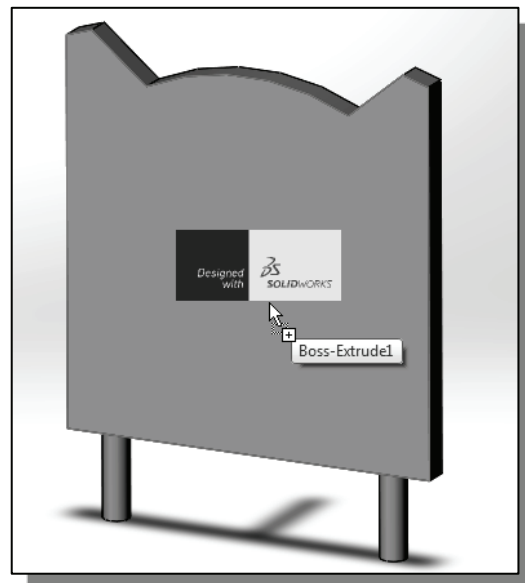

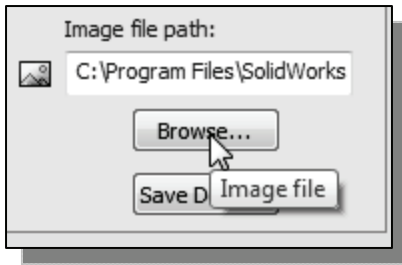

6. Click the **Browse** button in the *Decal Editing Manager* as shown.

7. Select the **TigerFace.bmp** in the *Mechanical-Tiger* project folder.

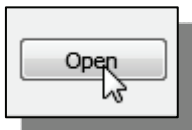
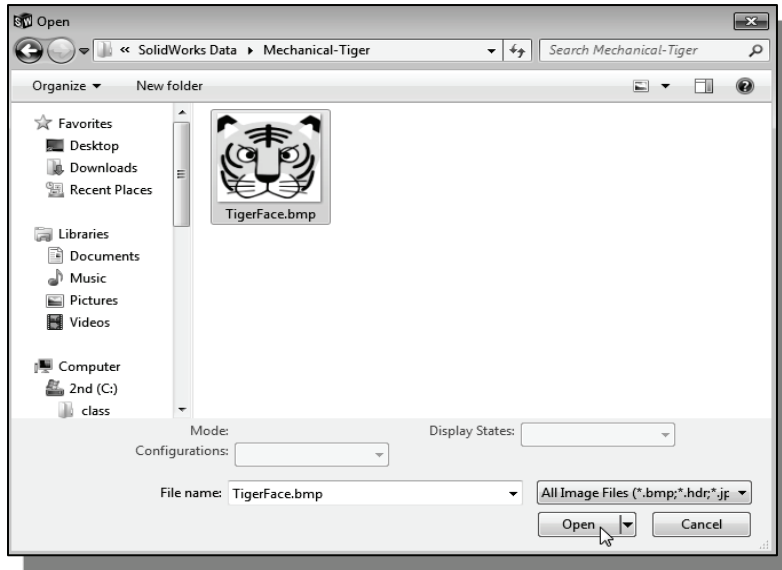

8. Click **Open** to import the image into the current model.

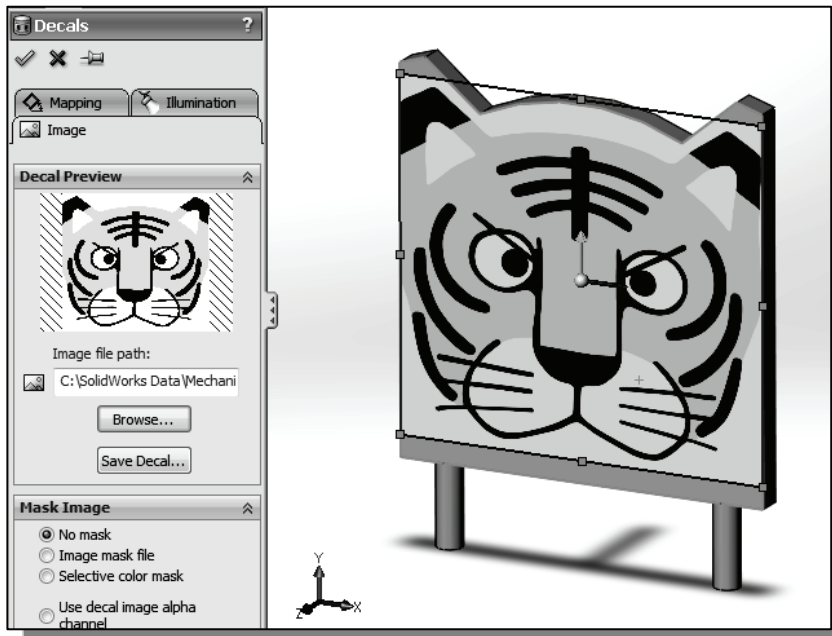



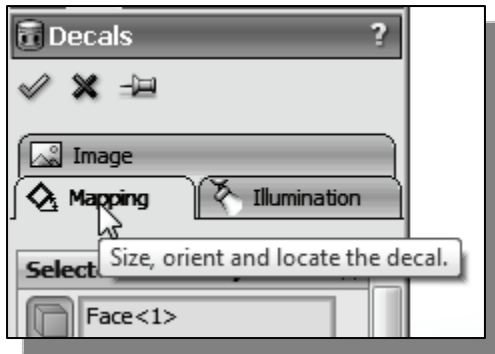

9. Switch to the **Mapping** options by clicking on the associated tab as shown.

10. In the **Size/Orientation** section, turn **OFF** the *Fixed aspect ratio* option, and turn **ON** the *Fit width to selection* option as shown.

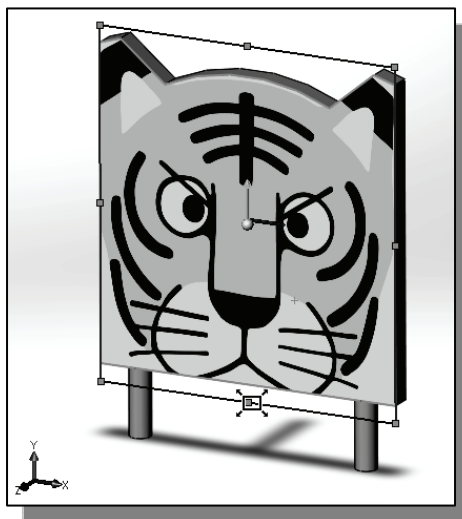
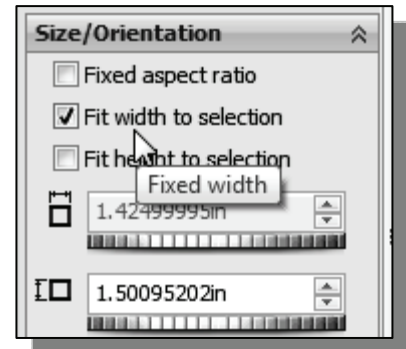

11. On your own, adjust the height of the decal by dragging one of the control-points using the left-mouse-button as shown.

12. Click **OK** to end the Decals option.

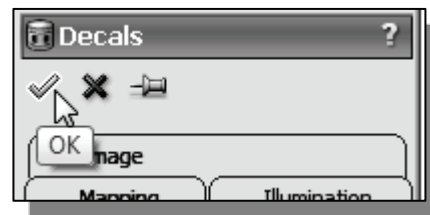

### Save the Model

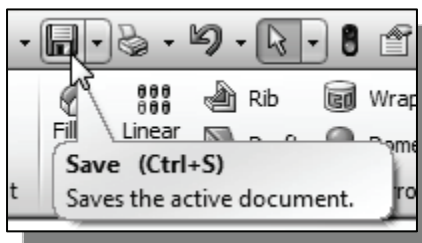

1. Select **Save** in the *Quick Access* toolbar, or you can also use the “**Ctrl-S**” combination (hold down the “**Ctrl**” key and hit the “**S**” key once) to save the part.

2. In the *File name* editor box, enter **Tiger-Head** as the file name.

3. Click on the **Save** button to save the file.

❖ You should form a habit of saving your work periodically, just in case something might go wrong while you are working on it. In general, one should save one’s work at an interval of every 15 to 20 minutes. One should also save before making any major modifications to the model.

## Questions:

1. What is the first thing we should set up in *SolidWorks* when creating a new model?
2. Describe the general *parametric modeling* procedure.
3. Describe the general guidelines in creating *rough sketches*.
4. List two of the geometric constraint symbols used by *SolidWorks*.
5. What was the first feature we created in this lesson?
6. How many solid features were created in the tutorial?
7. How do we control the size of a feature in parametric modeling?
8. Which command was used to create the last cut feature in the tutorial? How many dimensions do we need to fully describe the cut feature?
9. List and describe three differences between *parametric modeling* and traditional 2D *computer aided drafting* techniques.

**Exercises:**

1. **Inclined Support (Thickness: .5)**

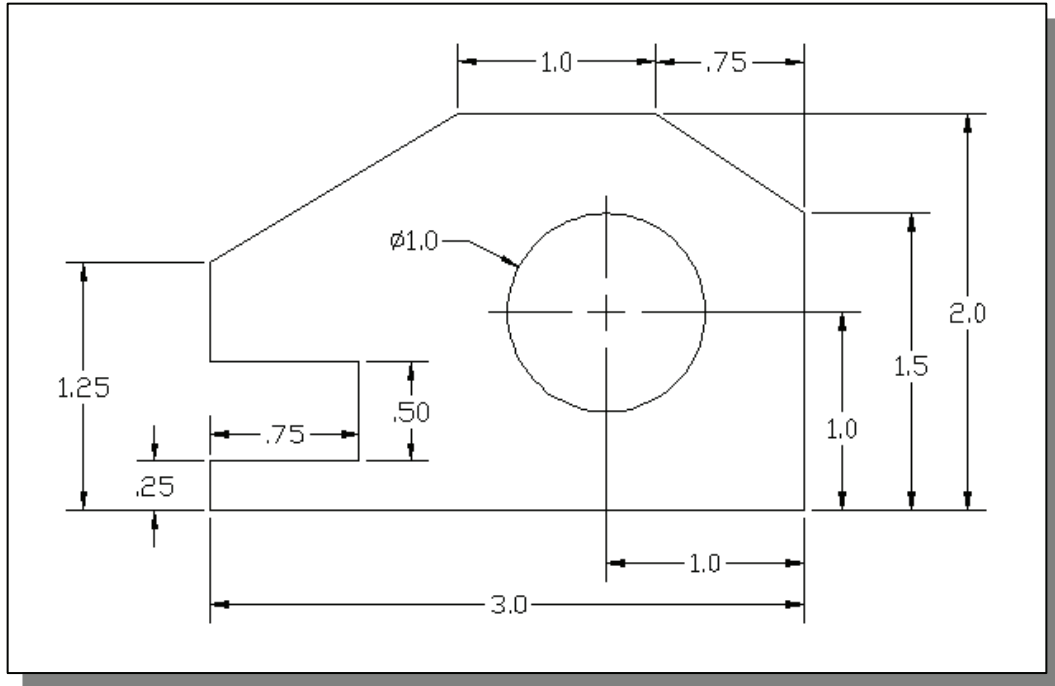

2. **Spacer Plate (Thickness: .125)**

