

# SolidWorks® 2013 Tutorial with Video Instruction

A Step-by-Step Project Based Approach  
Utilizing 3D Solid Modeling

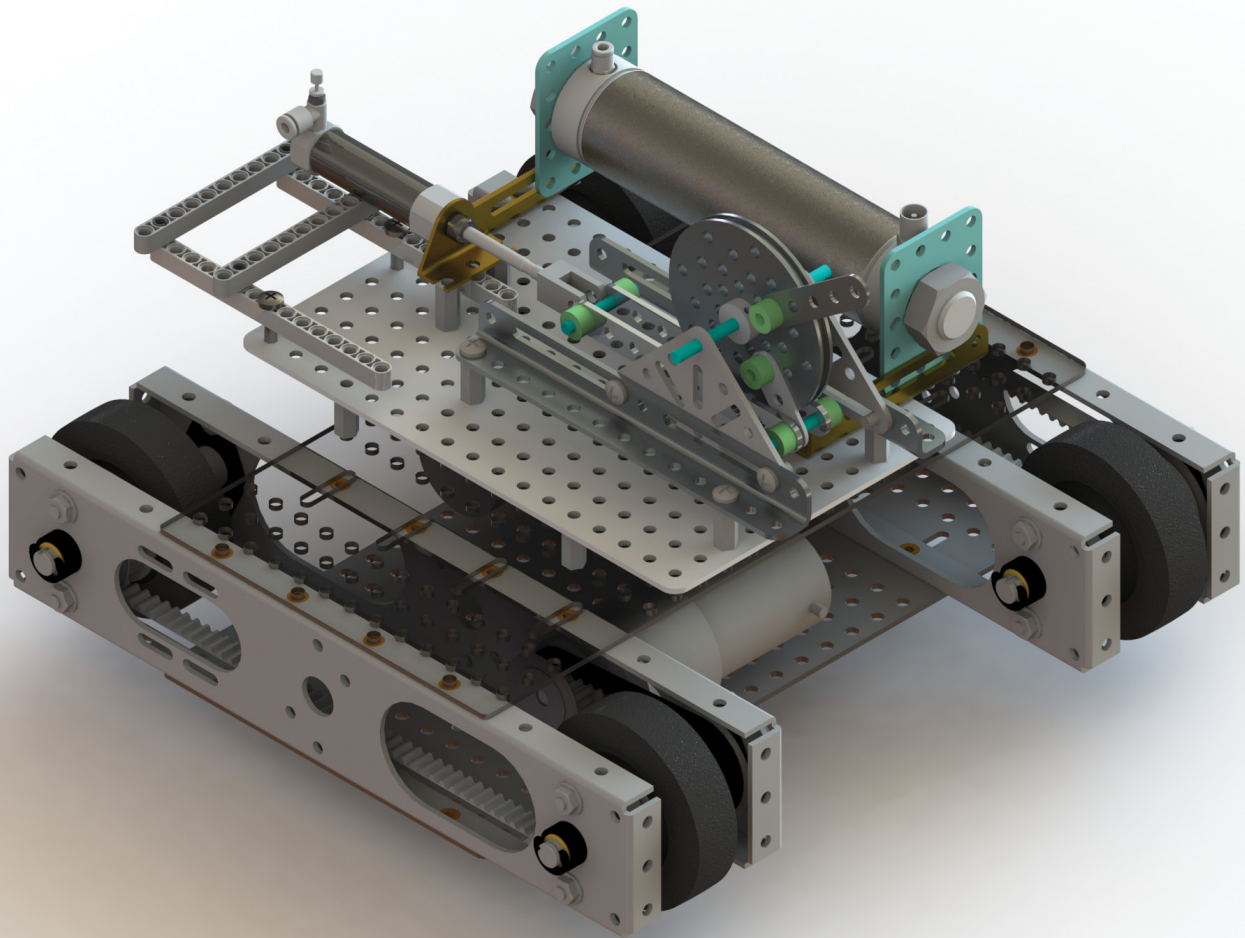

David C. Planchard CSWP  
Marie P. Planchard CSWP

**Better Textbooks. Lower Prices.**  
[www.SDCpublications.com](http://www.SDCpublications.com)

**SDC**  
PUBLICATIONS  
Schroff Development Corporation



Visit the following websites to learn more about this book:



[amazon.com](https://www.amazon.com)

[BARNES & NOBLE](https://www.barnesandnoble.com)

[Google books](https://books.google.com)

---

# Chapter 1

## LINKAGE Assembly

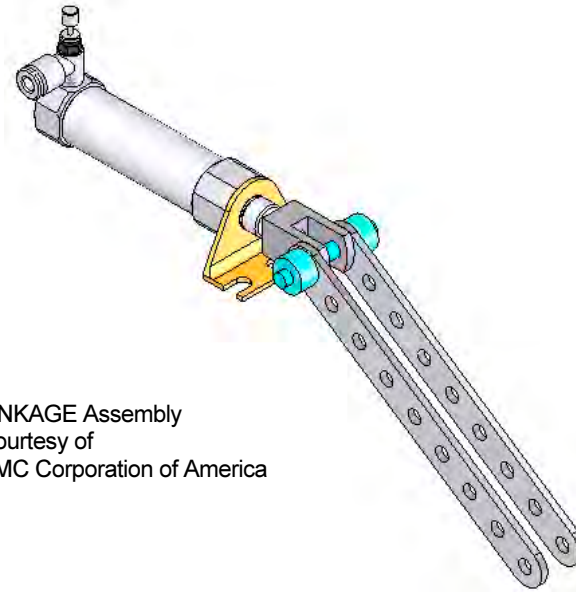

LINKAGE Assembly  
Courtesy of  
SMC Corporation of America

Below are the desired outcomes and usage competencies based on the completion of Chapter 1.

Desired Outcomes:	Usage Competencies:
<ul style="list-style-type: none"><li>• Create three parts:<ul style="list-style-type: none"><li>○ AXLE</li><li>○ SHAFT-COLLAR</li><li>○ FLATBAR</li></ul></li></ul>	<ul style="list-style-type: none"><li>• Understand the SolidWorks default User Interface. Establish a SolidWorks session.</li><li>• Create 2D sketch profiles on the correct Sketch plane.</li><li>• Apply the following 3D features: Extruded Boss/Base, Extruded Cut and Linear Pattern.</li></ul>
<ul style="list-style-type: none"><li>• Create an assembly:<ul style="list-style-type: none"><li>○ LINKAGE assembly</li></ul></li></ul>	<ul style="list-style-type: none"><li>• Understand the Assembly toolbar.</li><li>• Insert components into an assembly.</li><li>• Apply the following Standard mates: Concentric, Coincident and Parallel.</li></ul>

**Notes:**



## Chapter 1 - LINKAGE Assembly

### Chapter Objective

SolidWorks is a design software application used to model and create 2D and 3D sketches, 3D parts, 3D assemblies and 2D drawings. The chapter objective is to provide a comprehensive understanding of the SolidWorks default User Interface and CommandManager: *Menu bar toolbar, Menu bar menu, Drop-down menu, Context toolbar / menus, Fly-out FeatureManager, System feedback, Confirmation Corner, Heads-up View toolbar and an understanding of Document Properties.*

Obtain the working familiarity of the following SolidWorks sketch and feature tools: *Line, Circle, Centerpoint Straight Slot, Smart Dimension, Extruded Boss/Base, Extruded Cut and Linear Pattern.*

Create three individual parts: AXLE, SHAFT-COLLAR and FLATBAR.

Create the assembly, LINKAGE using the three created parts and the downloaded subassembly - AirCylinder from the DVD in the book.

On the completion of this chapter, you will be able to:

- Start a SolidWorks session and navigate through the SolidWorks (UI) and CommandManager.
- Set units and dimensioning standards for a SolidWorks document.
- Generate a 2D sketch and identify the correct Sketch plane.
- Add and modify sketch dimensions.
- Create a 3D model.
- Understand and apply the following SolidWorks features:
  - Extruded Boss/Base, Extruded Cut and Linear Pattern
- Insert the following Geometric relations: Vertical, Horizontal, Coincident, MidPoint, Parallel and Equal.
- Download an assembly into SolidWorks and create an assembly.
- Understand the Assembly toolbar.
- Apply the following Standard mates: Coincident, Concentric and Parallel.

## Chapter Overview

SolidWorks is a 3D solid modeling CAD software package used to produce and model parts, assemblies, and drawings.

SolidWorks provides design software to create 3D models and 2D drawings.

Create three parts in this chapter:

- AXLE
- SHAFT-COLLAR
- FLATBAR

Download the AirCylinder assembly from the enclosed DVD.

 The AirCylinder assembly is also available from the internet.

Combine the created parts and the downloaded AirCylinder assembly to create the LINKAGE assembly.

 Illustrations in the book display the default SolidWorks user interface for 2013 SP0.

 Every license of SolidWorks contains a copy of SolidWorks SustainabilityXpress. SolidWorks SustainabilityXpress calculates environmental impact on a model in four key areas: *Carbon Footprint, Energy Consumption, Air Acidification and Water Eutrophication*. Material and Manufacturing process region and Transportation Use region are used as input variables.

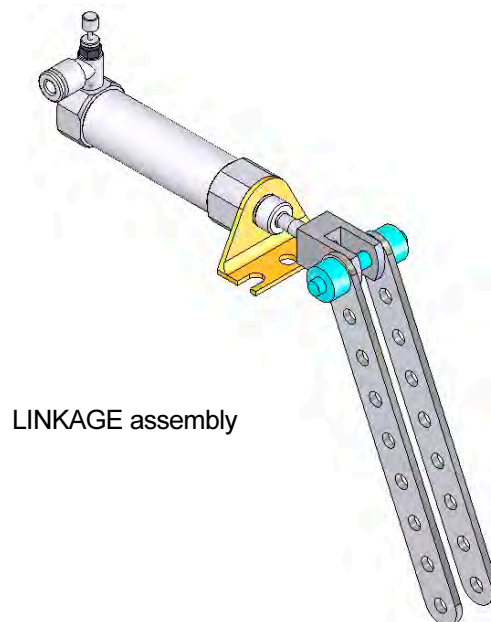
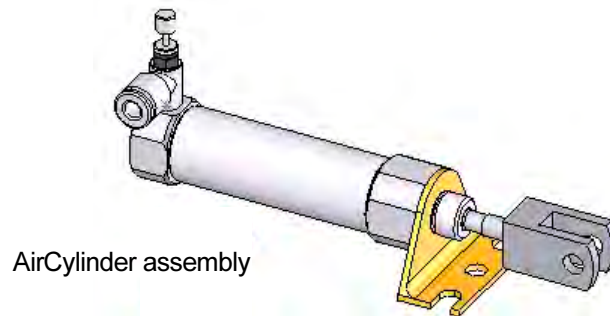
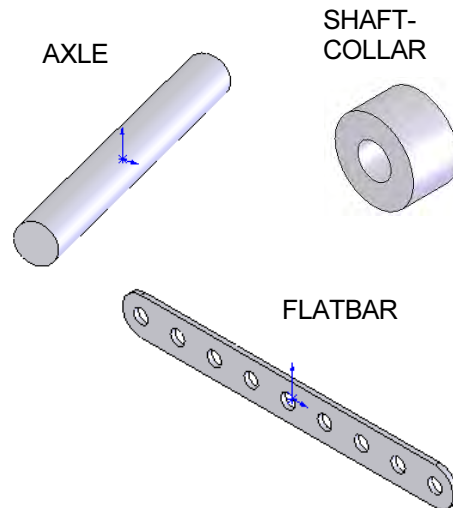

## AXLE Part

The AXLE is a cylindrical rod. The AXLE supports the two FLATBAR parts.

 Tangent edges and origins are displayed for educational purposes in this book.

The AXLE rotates about its axis. The dimensions for the AXLE are determined from other components in the LINKAGE assembly.

Start a new SolidWorks session. Create the AXLE part.

Apply the feature to create the part. Features are the building blocks that add or remove material.

Utilize the Extruded Boss/Base  tool from the Features toolbar to create a Boss-Extrude1 feature. The Extruded Boss/Base feature adds material. The Base feature (Boss-Extrude1) is the first feature of the part. The Base feature is the foundation of the part. Keep the Base feature simple!

The Base feature geometry for the AXLE is a simple extrusion. How do you create a solid Extruded Boss/Base feature for the AXLE?

- Select the Front Plane as the Sketch plane.
- Sketch a circular 2D profile on the Front Plane, centered at the Origin as illustrated.
- Apply the Extruded Boss/Base Feature. Extend the profile perpendicular ( $\perp$ ) to the Front Plane.

Utilize symmetry. Extrude the sketch with the Mid Plane End Condition in Direction 1. The Extruded Boss/Base feature is centered on both sides of the Front Plane.

Start a SolidWorks session. The SolidWorks application is located in the Programs folder.

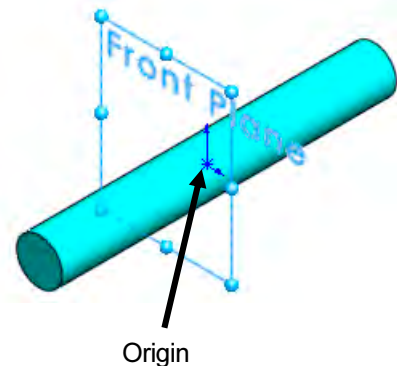
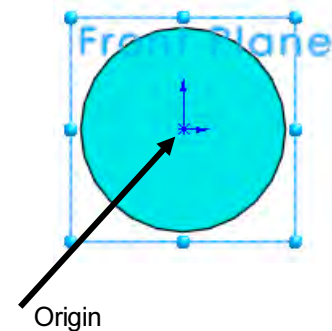
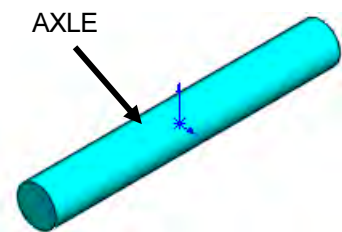
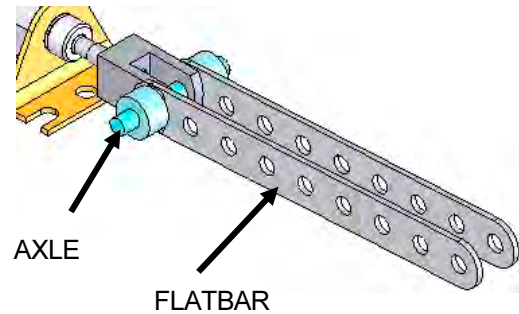





SolidWorks displays the Tip of the Day box. Read the Tip of the Day to obtain additional knowledge on SolidWorks.

Create a new part. Select File, New from the Menu bar toolbar or click New  from the Menu bar menu. There are two options for new documents: *Novice* and *Advanced*. Select the Advanced option. Select the default Part document.

### Activity: Start a SolidWorks Session

Start a SolidWorks 2013 session.

- 1) Click **Start** from the Windows Taskbar.
- 2) Click **All Programs**  **All Programs** .
- 3) Click the **SolidWorks 2013** folder.
- 4) Click the **SolidWorks 2013** application. The SolidWorks program window opens. Note: Do not open a document at this time.
- 5) If you do not see the below screen, click the **SolidWorks Resources**  tab on the right side of the Graphics window location in the Task Pane as illustrated.
- 6) **Hover** the mouse pointer over the SolidWorks icon as illustrated.
- 7) **Pin** the Menu Bar toolbar. View your options.

 If available, double-click the SolidWorks 2013 icon on the Windows Desktop to start a SolidWorks session.

 The book is written using Microsoft Office 2010 on Windows<sup>®</sup> 7 utilizing SolidWorks 2013 SP0.

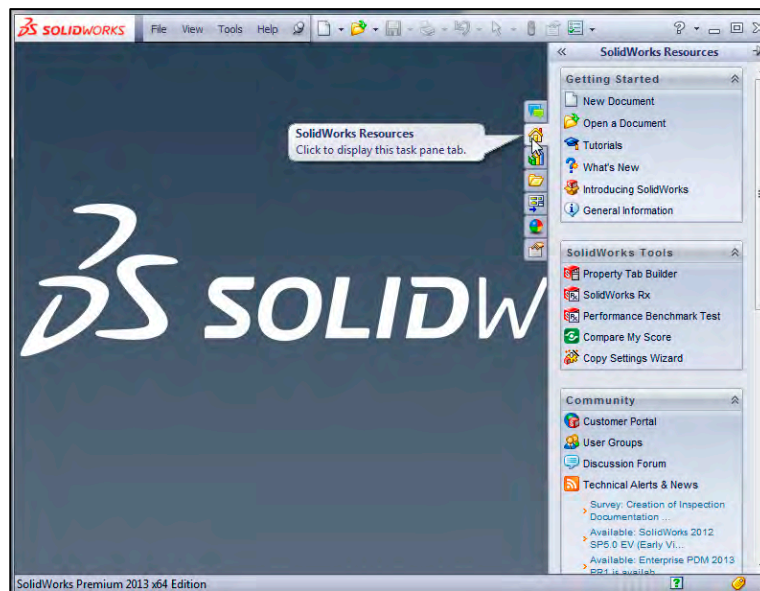













## Activity: Understand the SolidWorks User Interface and CommandManager

### Menu bar toolbar

SolidWorks 2013 (UI) is design to make maximum use of the Graphics window area. The default Menu bar toolbar contains a set of the most frequently used tool buttons from the Standard toolbar. The available tools are:



- **New**  - Creates a new document
- **Open**  - Opens an existing document
- **Save**  - Saves an active document
- **Print**  - Prints an active document
- **Undo**  - Reverses the last action
- **Select**  - Selects Sketch entities, components and more
- **Rebuild**  - Rebuilds the active part, assembly or drawing
- **File Properties**  - Shows the summary information on the active document
- **Options**  - Changes system options and Add-Ins for SolidWorks.

 The Search *Knowledge Base* and *Community Forum* option from the Menu Bar toolbar requires Internet access.

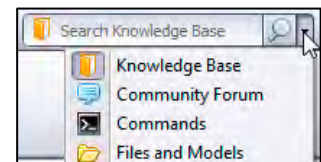



### Menu bar menu

Click SolidWorks in the Menu bar toolbar to display the Menu bar menu. SolidWorks provides a Context-sensitive menu structure.

The menu titles remain the same for all three types of documents, but the menu items change depending on which type of document is active.



Example: The Insert menu includes features in part documents, mates in assembly documents, and drawing views in drawing documents. The display of the menu is also dependent on the workflow customization that you have selected. The default menu items for an active document are: *File, Edit, View, Insert, Tools, Window, Help, Pin*.

 The Pin  option displays the Menu bar toolbar and the Menu bar menu as illustrated. Throughout the book, the Menu bar menu and the Menu bar toolbar is referred as the Menu bar.

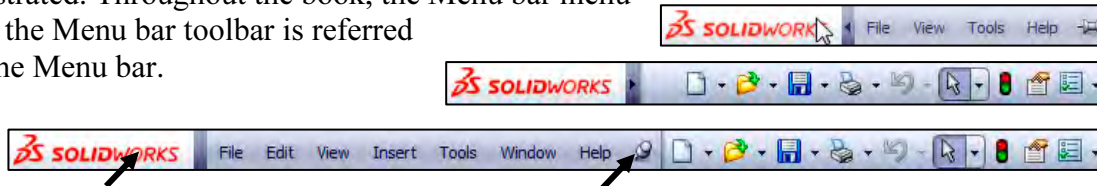

 Until a file is converted to the current version of SolidWorks and saved, a warning icon is displayed on the Save tool as illustrated.

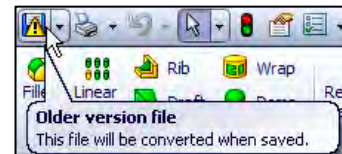

**Drop-down menu**

SolidWorks takes advantage of the familiar Microsoft® Windows® user interface. Communicate with SolidWorks either through the; *Drop-down menu, Pop-up menu, Shortcut toolbar, Fly-out toolbar* or the *CommandManager*.

A command is an instruction that informs SolidWorks to perform a task. To close a SolidWorks drop-down menu, press the Esc key. You can also click any other part of the SolidWorks Graphics window, or click another drop-down menu.

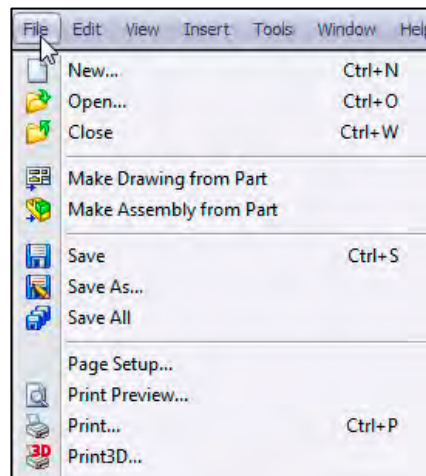

**Right-click**

Right-click in the: *Graphics window, FeatureManager, or Sketch* to display a Context-sensitive toolbar. If you are in the middle of a command, this toolbar displays a list of options specifically related to that command.

 Press the s key to view/access previous command tools in the Graphics window.

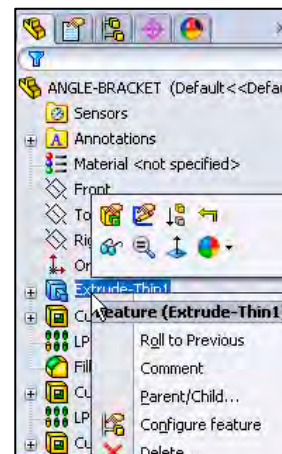

### Consolidated toolbar

Similar commands are grouped in the CommandManager.

Example: Variations of the Rectangle sketch tool are grouped in a single fly-out button as illustrated.

If you select the Consolidated toolbar button without expanding:

- For some commands such as Sketch, the most commonly used command is performed. This command is the first listed and the command shown on the button.

- For commands such as rectangle, where you may want to repeatedly create the same variant of the rectangle, the last used command is performed. This is the highlighted command when the Consolidated toolbar is expanded.

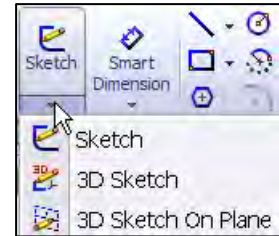
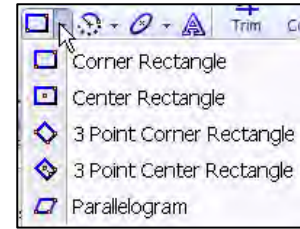

### System feedback

SolidWorks provides system feedback by attaching a symbol to the mouse pointer cursor. The system feedback symbol indicates what you are selecting or what the system is expecting you to select.

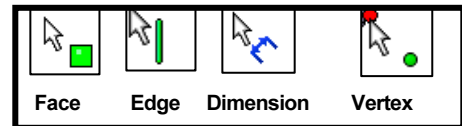

As you move the mouse pointer across your model, system feedback is provided to you in the form of symbols, riding next to the cursor arrow as illustrated.

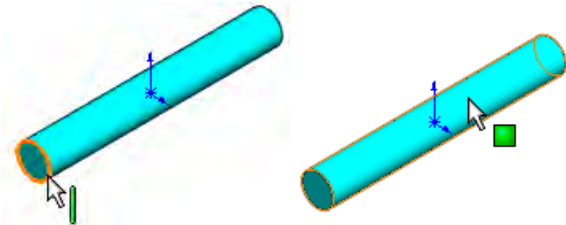

### Confirmation Corner

When numerous SolidWorks commands are active, a symbol or a set of symbols are displayed in the upper right hand corner of the Graphics window. This area is called the Confirmation Corner.

When a sketch is active, the confirmation corner box displays two symbols. The first symbol is the sketch tool icon. The second symbol is a large red X. These two symbols supply a visual reminder that you are in an active sketch. Click the sketch symbol icon to exit the sketch and to save any changes that you made.

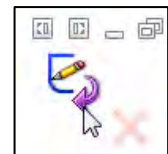

When other commands are active, the confirmation corner box provides a green check mark and a large red X. Use the green check mark to execute the current command. Use the large red X to cancel the command.







## Heads-up View toolbar

SolidWorks provides the user with numerous view options from the Standard Views, View and Heads-up View toolbar.

The Heads-up View toolbar is a transparent toolbar that is displayed in the Graphics window when a document is active.

You can hide, move or modify the Heads-up View toolbar. To modify the Heads-up View toolbar: right-click on a tool and select or deselect the tools that you want to display.

The following views are available:  
Note: *The available views are document dependent.*

- *Zoom to Fit* : Zooms the model to fit the Graphics window.
- *Zoom to Area* : Zooms to the areas you select with a bounding box.
- *Previous View* : Displays the previous view.
- *Section View* : Displays a cutaway of a part or assembly, using one or more cross section planes.



The Orientation dialog has a new option to display a view cube (in-context View Selector) with a live model preview. This helps the user to understand how each standard view orientates the model. With the view cube, you can access additional standard views. The views are easy to understand and they can be accessed simply by selecting a face on the cube.

To activate the Orientation dialog box, press the spacebar or click the View Orientation  icon from the Heads up View toolbar. The active model is displayed in the View Selector in an Isometric orientation (default view).

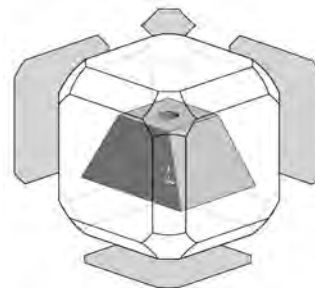
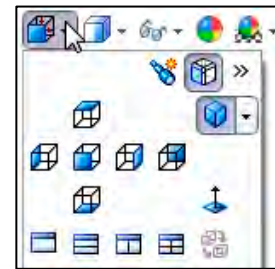
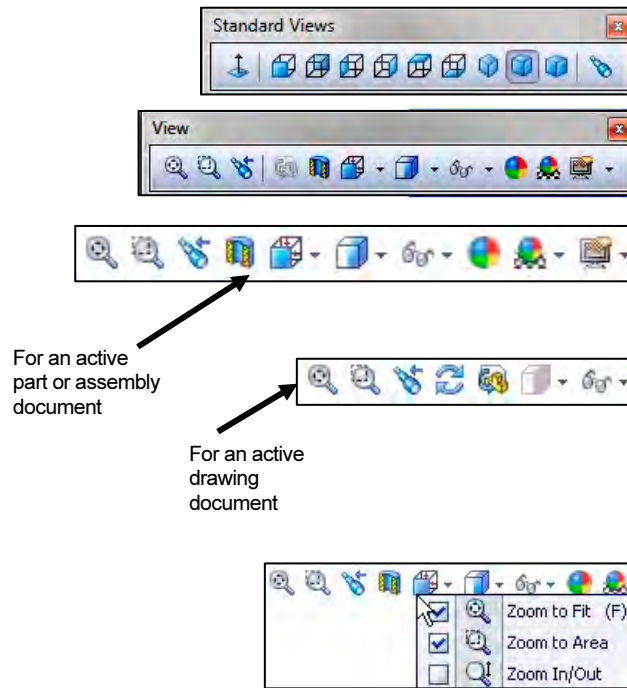

As you hover over the buttons in the Orientation dialog box, the corresponding faces dynamical highlight in the View Selector. Select a view in the View Selector or click the view from the Orientation dialog box. The Orientation dialog box closes and the model rotates to the selected view.





 Click the View Selector icon in the Orientation dialog box to show or hide the in-context View Selector.

 Press **Ctrl + spacebar** to activate the View Selector.

 Press the **spacebar** to activate the Orientation dialog box.

- **View Orientation box** : Provides the ability to select a view orientation or the number of viewports. The available options are: *Top, Left, Front, Right, Back, Bottom, Single view, Two view - Horizontal, Two view - Vertical, Four view*. Click the drop-down arrow  to access Axonometric views: Isometric, Dimetric and Trimetric.

- **Display Style** : Provides the ability to display the style for the active view: The available options are: *Wireframe, Hidden Lines Visible, Hidden Lines Removed, Shaded, Shaded With Edges*.



- **Hide/Show Items** : Provides the ability to select items to hide or show in the Graphics window. The available items are document dependent. Note the View Center of Mass  icon.

- **Edit Appearance** : Provides the ability to edit the appearance of entities of the model.

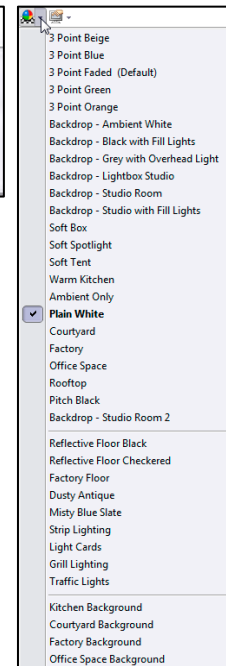
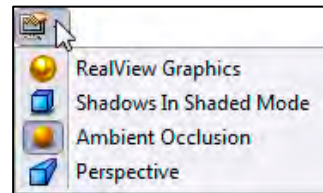
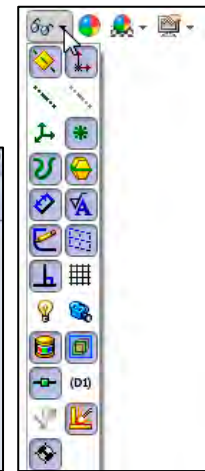
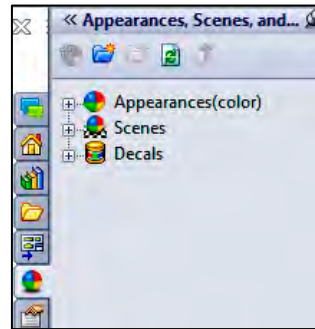
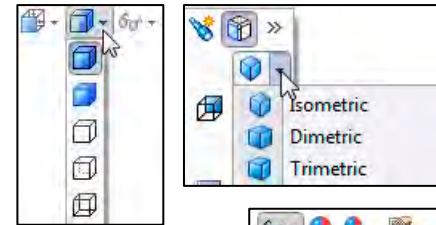
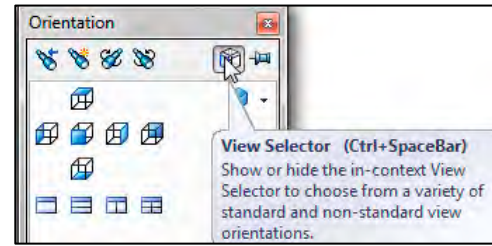

- **Apply Scene** : Provides the ability to apply a scene to an active part or assembly document. View the available options.



- **View Setting** : Provides the ability to select the following settings: *RealView Graphics, Shadows In Shaded Mode, Ambient Occlusion and Perspective*.

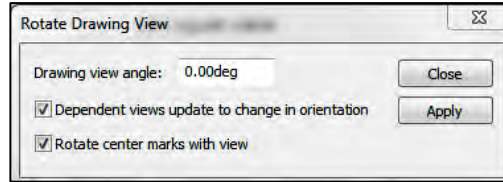



- *Rotate view* : Provides the ability to rotate a drawing view. Input Drawing view angle and select the ability to update and rotate center marks with view.
- *3D Drawing View* : Provides the ability to dynamically manipulate the drawing view in 3D to make a selection.

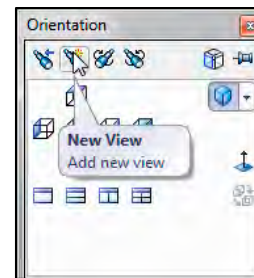

 The default part and document setting displays the grid. To deactivate the grid, click Options , Document Properties tab. Click Grid/Snaps; uncheck the Display grid box.

 Add a custom view to the Heads-up View toolbar. Press the space key. The Orientation dialog box is display. Click the New View  tool. The Name View dialog box is displayed. Enter a new named view. Click OK.



 The book does not cover starting a SolidWorks session in detail for the first time. A default SolidWorks installation presents you with several options. For additional information, visit the following sites: <http://www.solidworks.com/goedu> and [http://www.solidworks.com/sw/education/6443\\_ENU\\_HTML.htm](http://www.solidworks.com/sw/education/6443_ENU_HTML.htm).

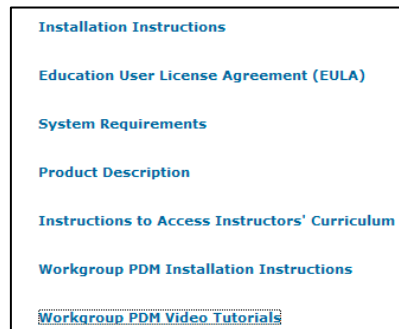

### SolidWorks Help and Tutorials

The SolidWorks Help Topics contains step-by-step instructions for various commands.

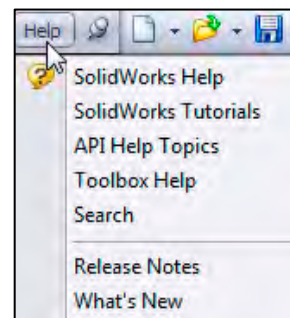

The Help  icon is displayed in the dialog box or in the PropertyManager for each feature. Display the SolidWorks Help Home Page. Use SolidWorks Help to locate information on What's New, sketches, features, assemblies and more.



- Click **Help** from the Menu bar.
- Click **SolidWorks Help**. The SolidWorks Help Home Page is displayed by default. View your options.

 SolidWorks Web Help is active by default under Help in the Main menu.

Close Help. Return to the SolidWorks Graphics window.

- Click the **Home Page**  icon to return to the Home Page.
- **Close**  the SolidWorks Home Page dialog box.

Display and explore the SolidWorks tutorials.

- Click **Help** from the Menu bar.
- Click **SolidWorks Tutorials**. The SolidWorks Tutorials are displayed. The SolidWorks Tutorials are presented by category.
- Click the **Getting Started** category. The Getting Started category provides 30-minute lessons on parts, assemblies, and drawings. This section also provides information for new users who are switching from AutoCAD to SolidWorks. The tutorials provide links to the CSWP and CSWA certification programs and a new What's New Tutorials for 2013.

 SolidWorks Corporation offers various levels of certification representing increasing levels of expertise in 3D CAD design as it applies to engineering.

The *Certified SolidWorks Associate* CSWA certification indicates a foundation in and apprentice knowledge of 3D CAD design and engineering practices and principles.

The main requirement for obtaining the CSWA certification is to take and pass the three hour, seven question on-line proctored exam at a Certified SolidWorks CSWA Provider; “university, college, technical, vocational or secondary educational institution” and to sign the SolidWorks Confidentiality Agreement.

Passing this exam provides students the chance to prove their working knowledge and expertise and to be part of a worldwide industry certification standard.

- **Close** the  Online Tutorial dialog box. Return to the SolidWorks Graphics window.

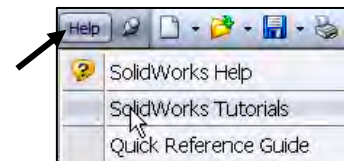

**SolidWorks CommandManager**

The SolidWorks CommandManager is a *Context-sensitive toolbar* that automatically updates based on the toolbar you want to access. By default, it has toolbars embedded in it based on your active document type. When you click a tab below the CommandManager, it updates to display that toolbar. Example, if you click the Sketch tab, the Sketch toolbar is displayed. The default Part tabs are: *Features, Sketch, Evaluate, DimXpert* and *Office Products*.

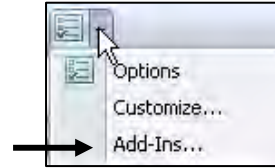

Below is an illustrated CommandManager for a default Part document.



If you have SolidWorks, SolidWorks Professional, or SolidWorks Premium, the Office Products tab appears on the CommandManager as illustrated.



Select the Add-Ins directly from the Office Products tab.

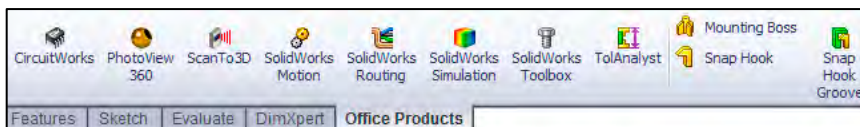
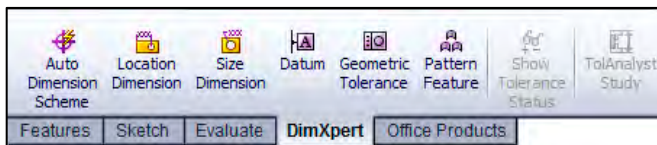
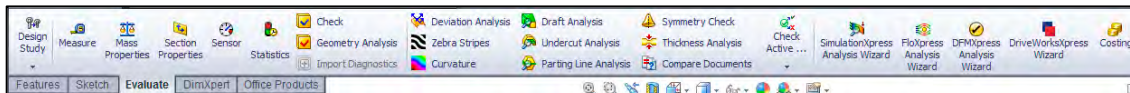
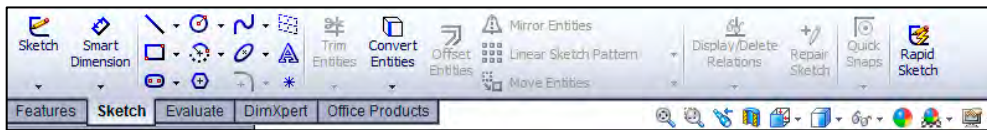

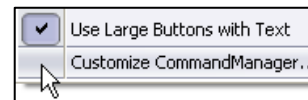

To customize the CommandManager, right-click on a tab and select *Customize CommandManager*.



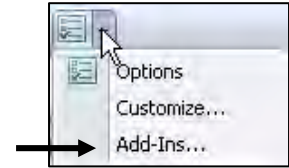

Below is an illustrated CommandManager for the default Drawing document. The default Drawing tabs are: *View Layout*, *Annotation*, *Sketch*, *Evaluate* and *Office Products*.



 Double-clicking the CommandManager when it is docked will make it float. Double-clicking the CommandManager when it is floating will return it to its last position in the Graphics window.

 Select the Add-Ins directly from the Office Products tab.

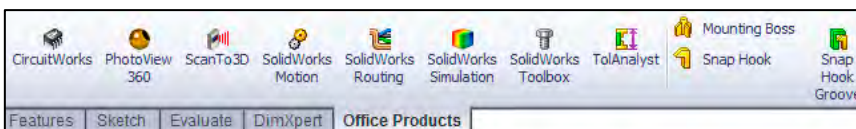
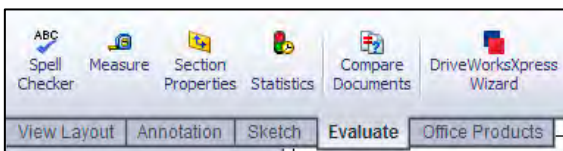
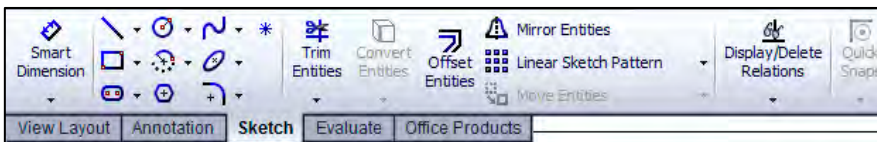
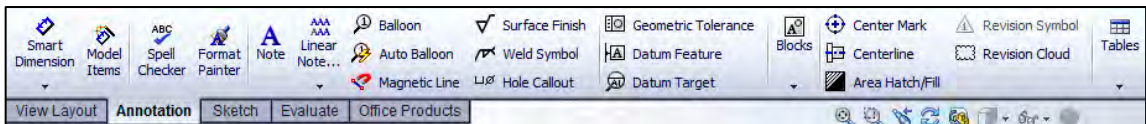
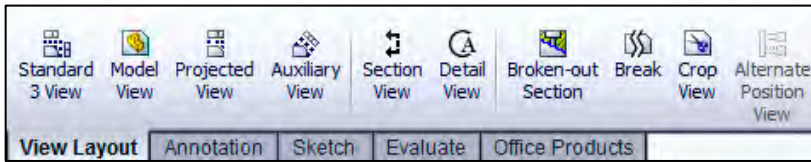

To add a custom tab to your CommandManager, right-click on a tab and click *Customize CommandManager* from the drop-down menu. The *Customize* dialog box is displayed.

You can also select to add a blank tab and populate it with custom tools from the *Customize* dialog box.

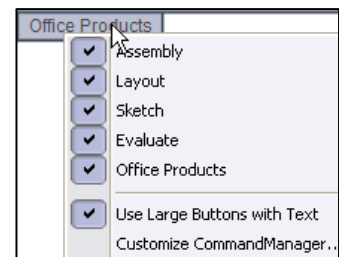

Below is an illustrated CommandManager for the default Assembly document. The default Assembly tabs are: *Assembly*, *Layout*, *Sketch*, *Evaluate* and *Office Products*.

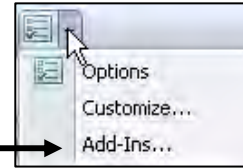

If you have SolidWorks, SolidWorks Professional, or SolidWorks Premium, the Office Products tab appears on the CommandManager



Select the Add-Ins directly from the Office Products tab.



Instant3D and Rapid Sketch tool is active by default.

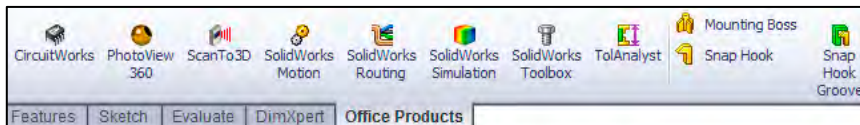
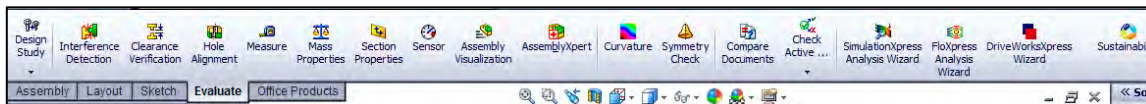
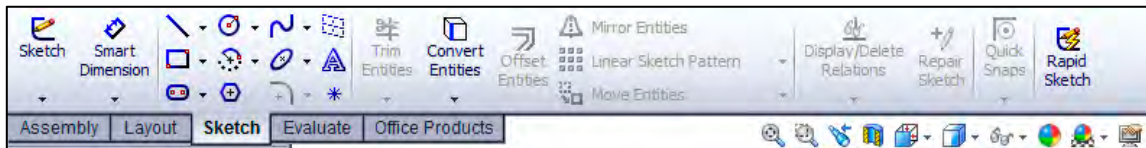
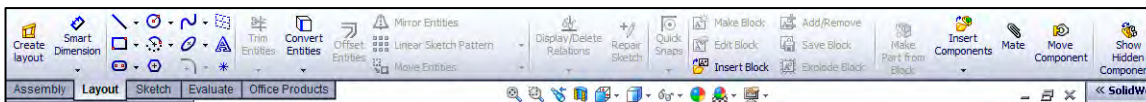
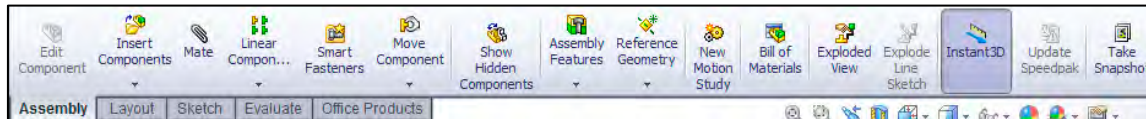

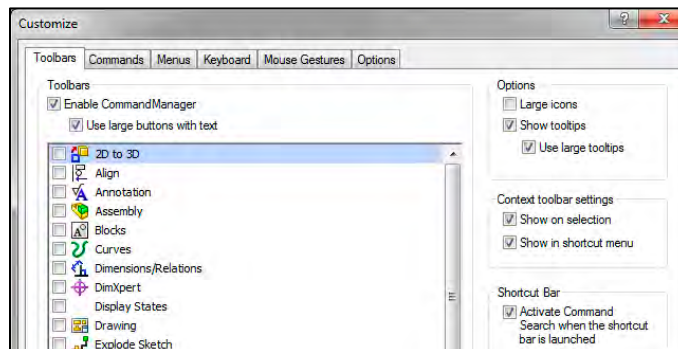

By default, the illustrated options are selected in the Customize box for the CommandManager.

Right-click on an existing tabs, and click Customize CommandManager to view your options.



Drag or double-click the CommandManager and it becomes a separate floating window. Once it is floating, you can drag the CommandManager anywhere on or outside the SolidWorks window.

To dock the CommandManager when it is floating, perform one of the following actions:

- While dragging the CommandManager in the SolidWorks window, move the pointer over a docking icon -  Dock above,  Dock left,  Dock right and click the needed command.
- Double-click the floating CommandManager to revert the CommandManager to the last docking position.

 Screen shots in the book were made using SolidWorks 2013 SP0 running Windows® 7 Ultimate.

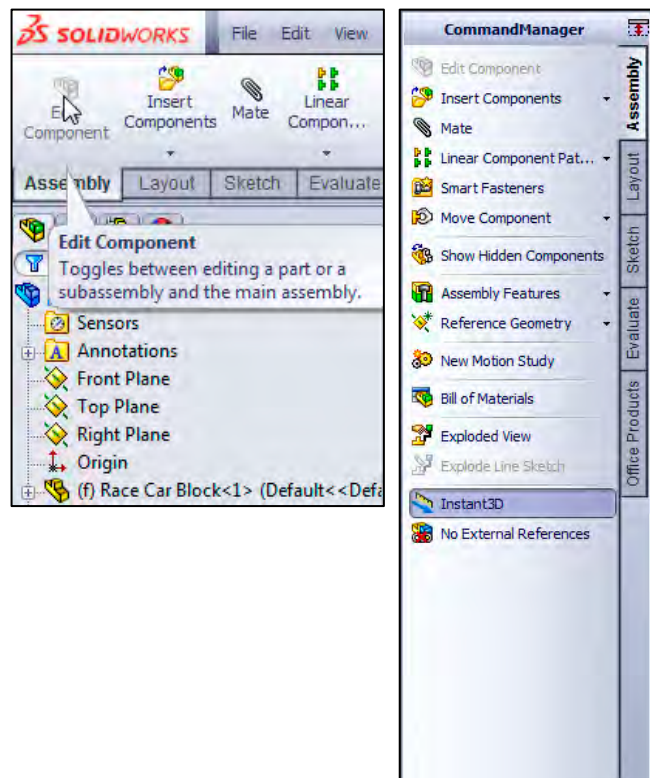



To save space in the CommandManager, right-click in the CommandManager and uncheck the Use Large Buttons with Text box. This eliminates the text associated with the tool.

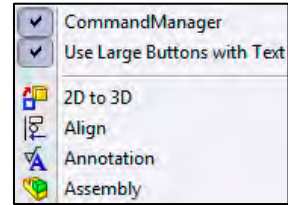





### FeatureManager Design Tree

The FeatureManager design tree is located on the left side of the SolidWorks Graphics window. The FeatureManager provides a summarize view of the active part, assembly, or drawing document. The tree displays the details on how the part, assembly or drawing document was created.



Understand the FeatureManager design tree to troubleshoot your model. The FeatureManager is used extensively throughout this book.

The FeatureManager consist of five default tabs:

- *FeatureManager design tree*  tab
- *PropertyManager*  tab
- *ConfigurationManager*  tab
- *DimXpertManager*  tab
- *DisplayManager*  tab

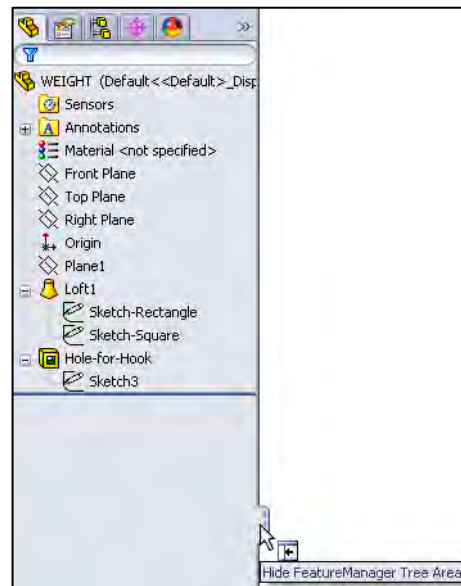

Select the Hide FeatureManager Tree Area arrows  as illustrated to enlarge the Graphics window for modeling.



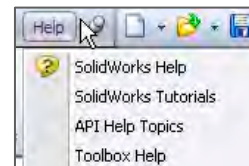

DimXpert provides the ability to graphically check if the model is fully dimensioned and tolerance. DimXpert automatically recognize manufacturing features. Manufacturing features are *not SolidWorks features*. Manufacturing features are defined in 1.1.12 of the ASME Y14.5M-1994 Dimensioning and Tolerancing standard. See SolidWorks Help for additional information.



When you create a new part or assembly, the three default Planes (Front, Right and Top) are align with specific views. The Plane you select for the Base sketch determines the orientation of the part.



Various commands provide the ability to control what is displayed in the FeatureManager design tree. They are:

1. Show or Hide FeatureManager items.

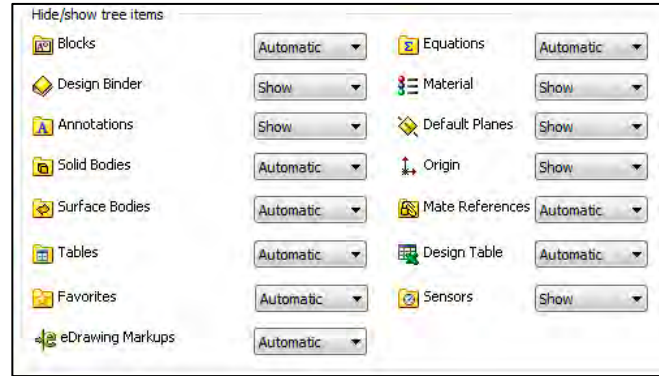
 Click **Options**  from the Menu bar. Click **FeatureManager** from the System Options tab. **Customize** your FeatureManager from the Hide/Show Tree Items dialog box.



2. Filter the FeatureManager design tree. Enter information in the filter field. You can filter by: *Type of features, Feature names, Sketches, Folders, Mates, User-defined tags and Custom properties.*

 Tags are keywords you can add to a SolidWorks document to make them easier to filter and to search. The Tags  icon is located in the bottom right corner of the Graphics window.

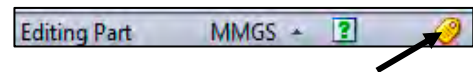
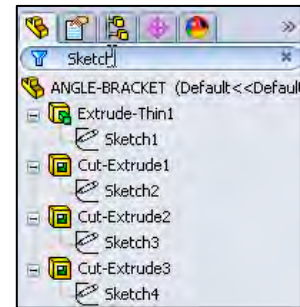

 To collapse all items in the FeatureManager, **right-click** and select **Collapse items**, or press the **Shift +C** keys.

The FeatureManager design tree and the Graphics window are dynamically linked. Select sketches, features, drawing views, and construction geometry in either pane.

Split the FeatureManager design tree and either display two FeatureManager instances, or combine the FeatureManager design tree with the ConfigurationManager or PropertyManager.

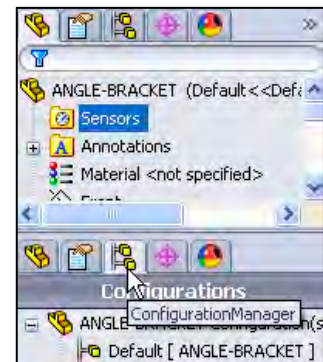



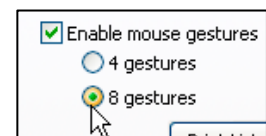

Move between the FeatureManager design tree, PropertyManager, ConfigurationManager, and DimXpertManager by selecting the tabs at the top of the menu.

 Right-click and drag in the Graphics area to display the Mouse Gesture wheel. You can customize the default commands for a sketch, part, assembly or drawing.



The ConfigurationManager is located to the right of the FeatureManager. Use the ConfigurationManager to create, select and view multiple configurations of parts and assemblies.

The icons in the ConfigurationManager denote whether the configuration was created manually or with a design table.

The DimXpertManager tab provides the ability to insert dimensions and tolerances manually or automatically. The DimXpertManager provides the following selections: *Auto Dimension Scheme* , *Show Tolerance Status* , *Copy Scheme*  and *TolAnalyst Study* .

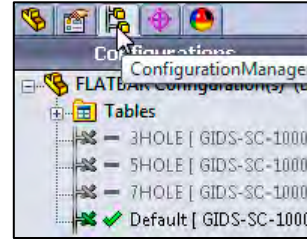

 TolAnalyst is available in SolidWorks Premium.

**Fly-out FeatureManager**

The fly-out FeatureManager design tree provides the ability to view and select items in the PropertyManager and the FeatureManager design tree at the same time.

Throughout the book, you will select commands and command options from the drop-down menu, fly-out FeatureManager, Context toolbar or from a SolidWorks toolbar.

 Another method for accessing a command is to use the accelerator key. Accelerator keys are special key strokes which activate the drop-down menu options. Some commands in the menu bar and items in the drop-down menus have an underlined character.

Press the Alt key followed by the corresponding key to the underlined character activates that command or option.

 Press the s key to view the Shortcut toolbar. Shortcut menus provide convenient access to previous applied tools and commands.

 Illustrations may vary depending on your SolidWorks version and operating system.

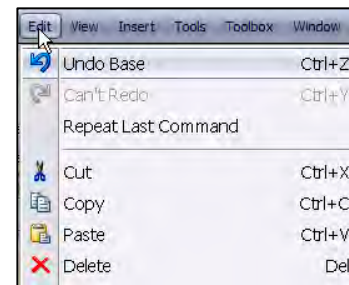
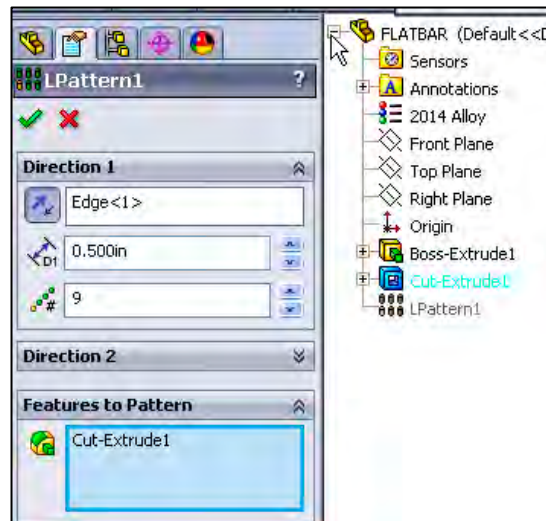

**Select**  
Selects sketch entities, edges, vertices, components, and so on.



## Task Pane

The Task Pane is displayed when a SolidWorks session starts. The Task Pane can be displayed in the following states: *visible or hidden, expanded or collapsed, pinned or unpinned, docked or floating.*

The Task Pane contains the following default tabs:

- *SolidWorks Forum*  tab
- *SolidWorks Resources*  tab
- *Design Library*  tab
- *File Explorer*  tab
- *View Palette*  tab
- *Appearances, Scenes, and Decals*  tab
- *Custom Properties*  tab



### SolidWorks Forum

Click the SolidWorks Forum  tab to search directly within the Task Pane. An internet connection is required. You are required to register and to login for postings and discussions.

 Additional tabs are displayed with Add-Ins. The SolidWorks Forum is an Add-in.

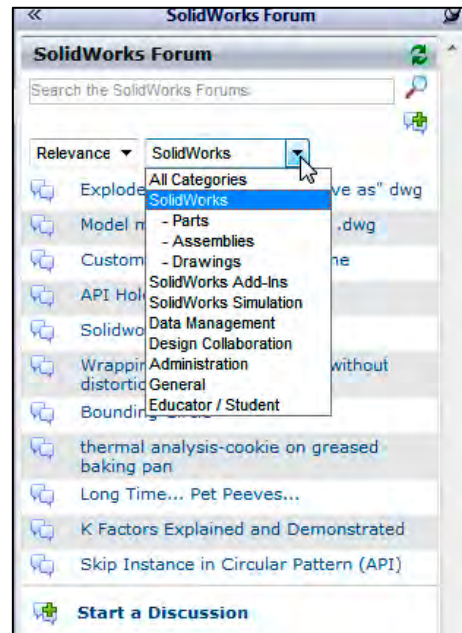
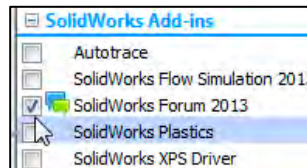

## SolidWorks Resources

The basic SolidWorks Resources  menu displays the following default selections: *Getting Started, SolidWorks Tools, Community, Online Resources* and *Tip of the Day*.

Other user interfaces are available during the initial software installation selection: *Machine Design, Mold Design* or *Consumer Products Design*.

## Design Library

The Design Library  contains reusable parts, assemblies, and other elements including library features.

The Design Library tab contains four default selections. Each default selection contains additional sub categories.

The default selections are:

- *Design Library*
- *Toolbox (Add-in)*
- *3D ContentCentral (Internet access required)*
- *SolidWorks Content (Internet access required)*

 Activate the SolidWorks Toolbox. Click Tools, Add-Ins., from the Main menu, check the SolidWorks Toolbox box and SolidWorks Toolbox Browser box from the Add-ins dialog box.

To access the Design Library folders in a non-network environment, click Add File Location  and browse to the needed path. Paths may vary depending on your SolidWorks version and window setup. In a network environment, contact your IT department for system details.

 Access the SolidWorks Toolbox directly from the Office Products tab.

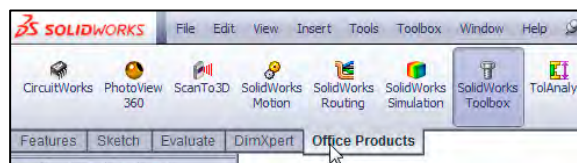
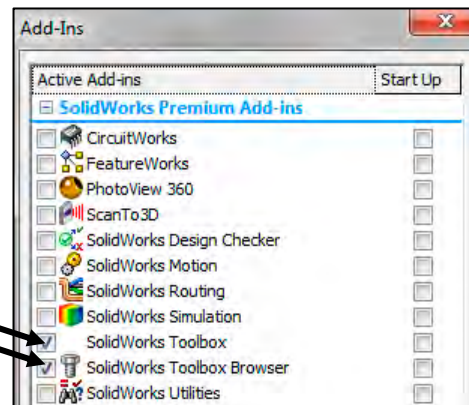
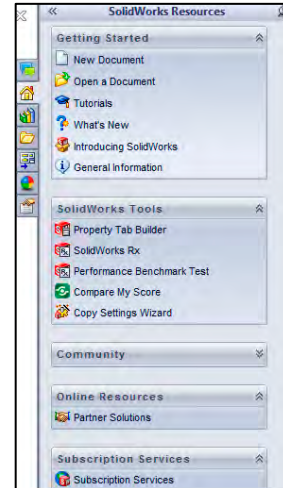
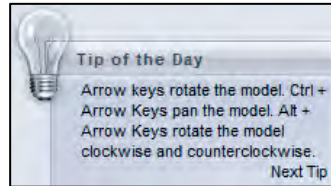



**File Explorer**

File Explorer  duplicates Windows Explorer from your local computer and displays:

- *Resent Documents*
- *Directories*
- *Open in SolidWorks and Desktop folders*

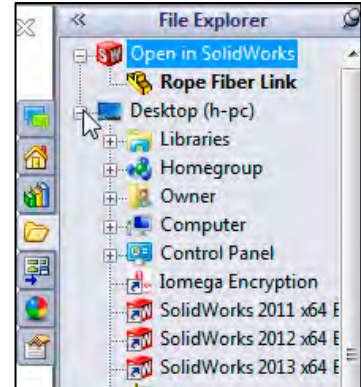

**Search**

The SolidWorks Search box is displayed in the upper right corner of the SolidWorks Graphics window (Menu Bar toolbar). Enter the text or key words to search.

New search modes have been added to SolidWorks Search. You can search the *Knowledge Base*, *Community Forum*, *Commands*, and *Files and Models*. Internet access is required for the Community Forum and Knowledge Base.

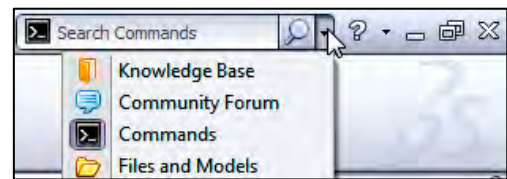

**View Palette**

The View Palette  tool located in the Task Pane provides the ability to insert drawing views of an active document, or click the Browse button to locate the desired document.

Click and drag the view from the View Palette into an active drawing sheet to create a drawing view.

 The selected model is 3LINKS in the illustration.

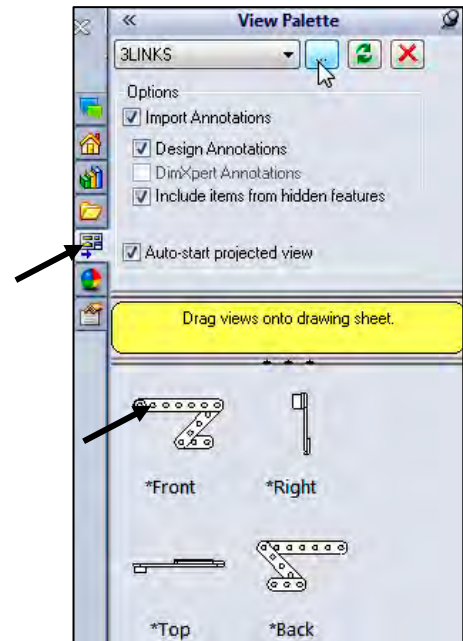

## Appearances, Scenes, and Decals

Appearances, Scenes, and Decals  provide a simplified way to display models in a photo-realistic setting using a library of Appearances, Scenes, and Decals.

An appearance defines the visual properties of a model, including color and texture. Appearances do not affect physical properties, which are defined by materials.

Scenes provide a visual backdrop behind a model. In SolidWorks, they provide reflections on the model. PhotoView 360 is an Add-in. Drag and drop a selected appearance, scene or decal on a feature, surface, part or assembly.





## Custom Properties

The Custom Properties  tool provides the ability to enter custom and configuration specific properties directly into SolidWorks files.

## Document Recovery

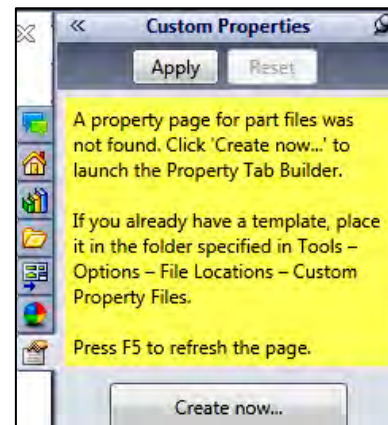
If auto recovery is initiated in the System Options section and the system terminates unexpectedly with an active document, the saved information files are available on the Task Pane Document Recovery tab the next time you start a SolidWorks session.



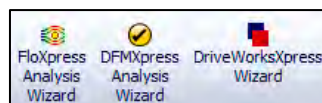

 Run DFMXpress from the Evaluate tab or from Tools  DFMXpress in the Menu bar menu. The DFMXpress icon is displayed in the Task Pane.



 To display the Selection Filter toolbar, click **View, Toolbars, Selection Filter**. The Selection Filter is displayed.



 To clear a Filter icon , click **Clear All Filters** from the Selection Filter toolbar.

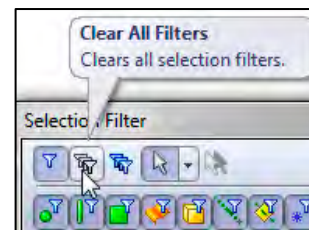

## Motion Study tab

Motion Studies are graphical simulations of motion for an assembly. Access MotionManager from the Motion Study tab. The Motion Study tab is located in the bottom left corner of the Graphics window.

Incorporate visual properties such as lighting and camera perspective. Click the Motion Study tab to view the MotionManager. Click the Model tab to return to the FeatureManager design tree.

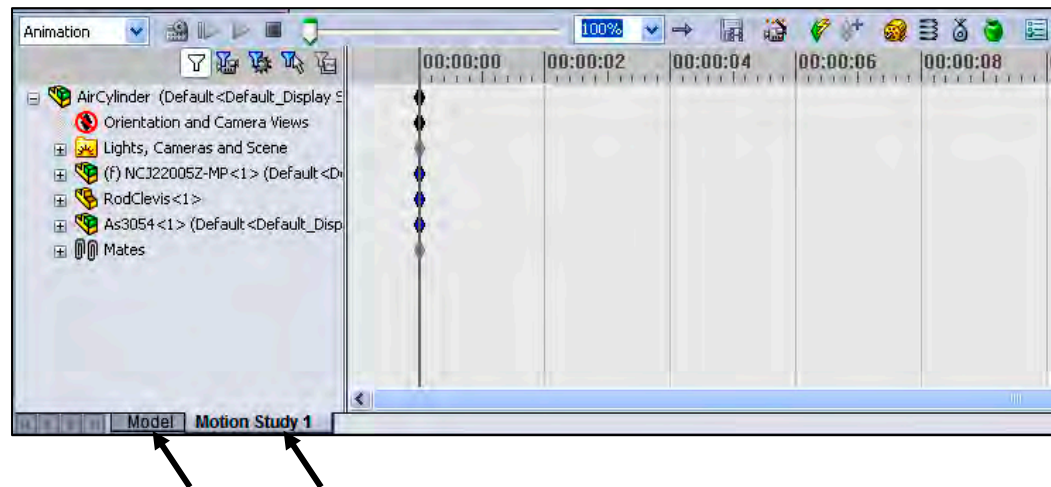

The MotionManager display a timeline-based interface, and provide the following selections from the drop-down menu as illustrated:

- *Animation*: Apply Animation to animate the motion of an assembly. Add a motor and insert positions of assembly components at various times using set key points. Use the Animation option to create animations for motion that do **not** require accounting for mass or gravity.
- *Basic Motion*: Apply Basic Motion for approximating the effects of motors, springs, collisions and gravity on assemblies. Basic Motion takes mass into account in calculating motion. Basic Motion computation is relatively fast, so you can use this for creating presentation animations using physics-based simulations. Use the Basic Motion option to create simulations of motion that account for mass, collisions or gravity.

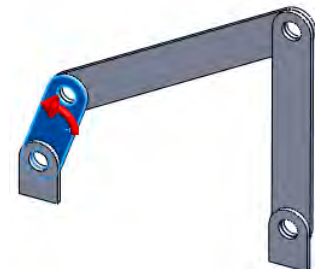
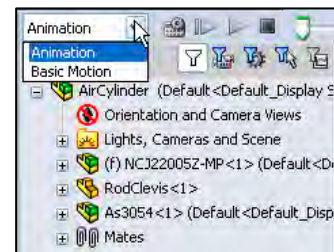

 If the Motion Study tab is not displayed in the Graphics window, click **View, MotionManager** from the Menu bar.



For older assemblies created before 2008, the Animation1 tab maybe displayed. View the Assembly Chapter for additional information.

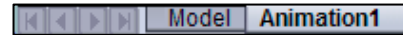

To create a new Motion Study, click **Insert, New Motion Study** from the Menu bar.



If the Motion Study tab is not displayed in the Graphics window, click **View, MotionManager** from the Menu bar.

### Activity: Create a New Part

A part is a 3D model, which consist of features. What are features?

- Features are geometry building blocks.
- Features add or remove material.
- Features are created from 2D or 3D sketched profiles or from edges and faces of existing geometry.
- Features are an individual shape that combined with other features, makes up a part or assembly. Some features, such as bosses and cuts, originate as sketches. Other features, such as shells and fillets, modify a feature's geometry.
- Features are displayed in the FeatureManager as illustrated (Extrude-Thin1, Cut-Extrude1, LPattern1, Fillet1, Cut-Extrude2, Lpatern2, and Cut-Extrude3).

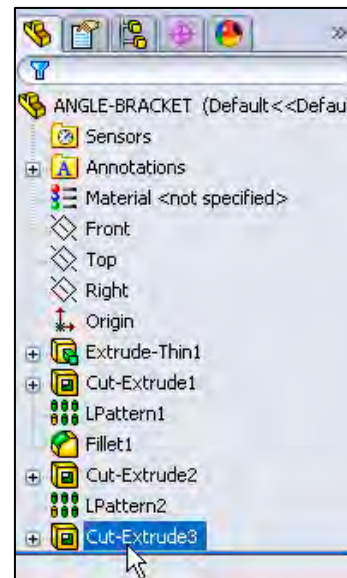

You can suppress a feature. A suppress feature is display in light gray.



The first sketch of a part is called the Base Sketch. The Base sketch is the foundation for the 3D model. The book focuses on 2D sketches and 3D features.



During the initial SolidWorks installation, you were requested to select either the ISO or ANSI drafting standard. ISO is typically; a European drafting standard and uses First Angle Projection. The book is written using the ANSI (US) overall drafting standard and Third Angle Projection for drawings.

There are two modes in the New SolidWorks Document dialog box: *Novice* and *Advanced*. The *Novice* option is the default option with three templates. The *Advanced* mode contains access to additional templates and tabs that you create in system options. Use the *Advanced* mode in this book.

Create a New part.

- 8) Click **New**  from the Menu bar. The New SolidWorks Document dialog box is displayed.

Select Advanced Mode.

- 9) Click the **Advanced** button to display the New SolidWorks Document dialog box in Advance mode.
- 10) The Templates tab is the default tab. Part is the default template from the New SolidWorks Document dialog box. Click **OK**.



SolidWorks Web Help is active by default under Help in the Main menu bar.

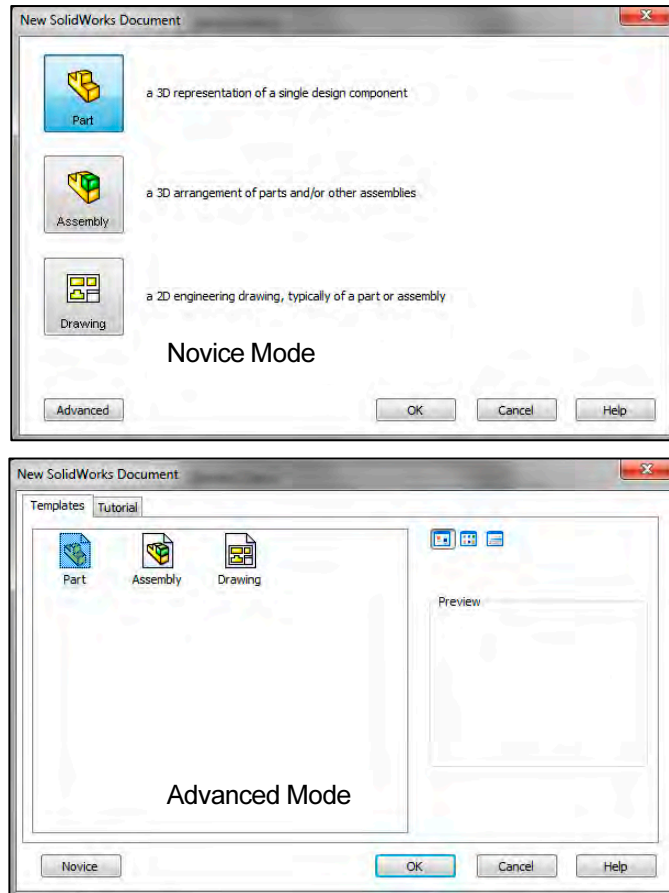

The *Advanced* mode remains selected for all new documents in the current SolidWorks session. When you exit SolidWorks, the *Advanced* mode setting is saved.

The default SolidWorks installation contains two tabs in the New SolidWorks Document dialog box: *Templates* and *Tutorial*. The *Templates* tab corresponds to the default SolidWorks templates. The *Tutorial* tab corresponds to the templates utilized in the SolidWorks Tutorials.



During the initial SolidWorks installation, you are request to select either the ISO or ANSI drafting standard. ISO is typically a European drafting standard and uses First Angle Projection. The book is written using the ANSI (US) overall drafting standard and Third Angle Projection for all drawing documents.

Part1 is displayed in the FeatureManager and is the name of the document. Part1 is the default part window name. The Menu bar, CommandManager, FeatureManager, Heads-up View toolbar, SolidWorks Resources, SolidWorks Search, Task Pane, and the Origin are displayed in the Graphics window.

The Origin  is displayed in blue in the center of the Graphics window. The Origin represents the intersection of the three default reference planes: *Front Plane*, *Top Plane* and *Right Plane*. The positive X-axis is horizontal and points to the right of the Origin in the Front view. The positive Y-axis is vertical and point upward in the Front view. The FeatureManager contains a list of features, reference geometry, and settings utilized in the part.

 Click **View, Origins** from the Menu bar menu to display the Origin in the Graphics window.

 Edit document units directly from the Graphics window as illustrated.

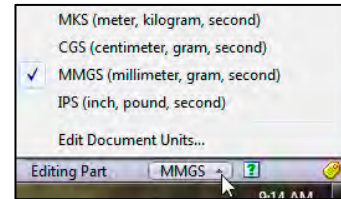

 Reference planes and Grid/Snaps are deactivated in the Graphics window for improved modeling clarity in the book.

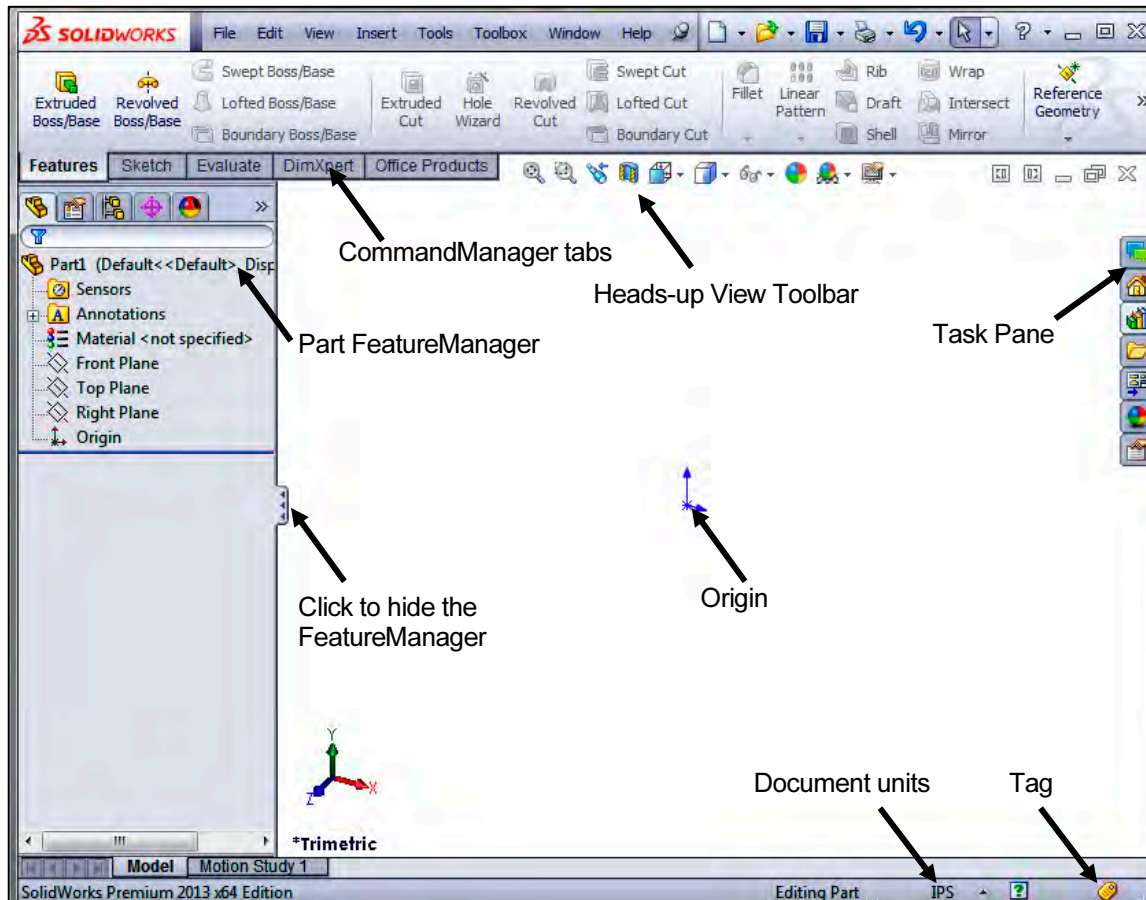

The CommandManager is document dependent. The tabs are located on the bottom left side of the CommandManager and display the available toolbars and features for each corresponding tab. The default tabs for a Part are: *Features*, *Sketch*, *Evaluate*, *DimXpert* and *Office Products*.

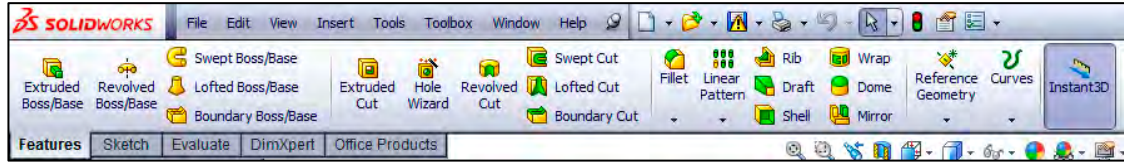

The Features icon and Features toolbar should be selected by default in Part mode.

The CommandManager is utilized in this text. Control the CommandManager display.

Right-click in the gray area to the right of the Options icon in the Menu bar toolbar. A complete list of toolbars is displayed. Check CommandManager if required.

 Another way to display a toolbar, click **View, Toolbars** from the Menu bar menu. Select the required toolbar.

Select individual toolbars from the View, Toolbars list to display in the Graphics window. Reposition toolbars by clicking and dragging.

 Click **View, Origins** from the Menu bar menu to display the Origin in the Graphics window.

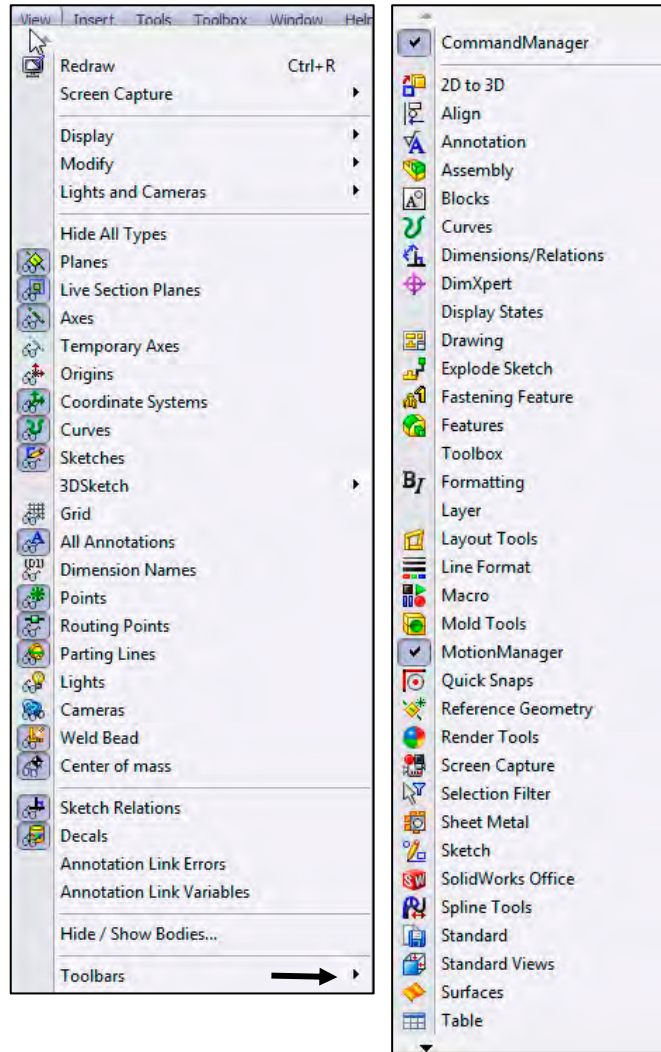

**Activity: Create the AXLE Part**

Set the Menu bar toolbar and Menu bar menu.

- 11) Click **SolidWorks** to expand the Menu bar menu.
- 12) **Pin** the Menu bar as illustrated. Use both the Menu bar menu and the Menu bar toolbar in this book.



The SolidWorks Help Topics contains step-by-step instructions for various commands. The Help icon is displayed in the dialog box or in the PropertyManager for each feature.

Set the Document Properties.

- 13) Click **Options** from the Menu bar. The System Options General dialog box is displayed
- 14) Click the **Document Properties** tab.
- 15) Select **ANSI** from the Overall drafting standard drop-down menu. Various Detailing options are available depending on the selected standard.

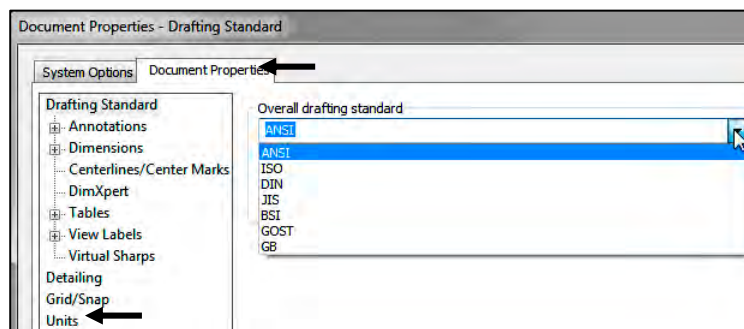
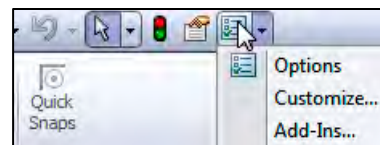

Various detailing options are available depending on the selected standard.

The Overall drafting standard determines the display of dimension text, arrows, symbols, and spacing. Units are the measurement of physical quantities. Millimeter dimensioning and decimal inch dimensioning are the two most common unit types specified for engineering parts and drawings.

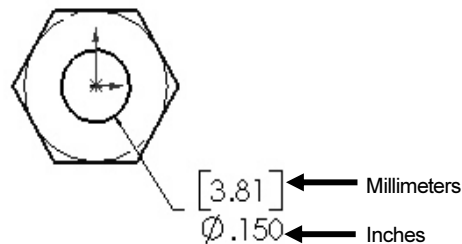

The primary units in this book are provided in IPS, (inch, pound, second). The optional secondary units are provided in MMGS, (millimeters, grams, second) and are indicated in brackets [ ].

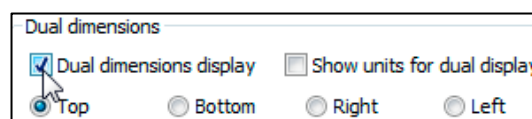
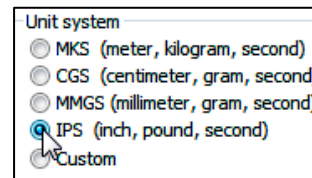





Most illustrations are provided in both inches and millimeters.

Set the document units.

- 16) Click **Units**.
- 17) Click **IPS** (inch, pound, second) [MMGS] for Unit system.
- 18) Select **.123, [.12]** (three decimal places) for Length basic units.
- 19) Select **None** for Angle decimal places.
- 20) Click **OK** from the Document Properties - Units dialog box. The Part FeatureManager is displayed.

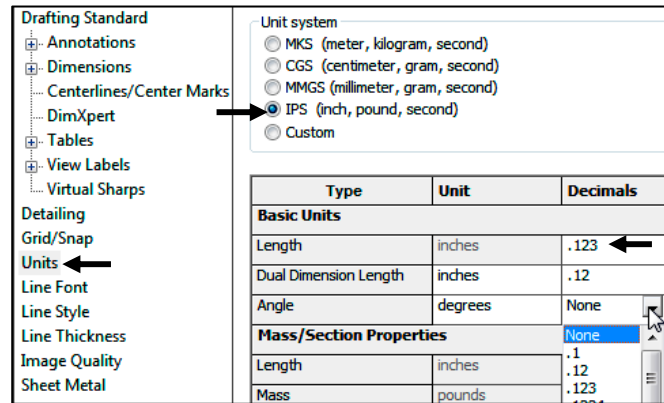

### Activity: AXLE Part-Extruded Base Feature

Insert a new sketch for the Extruded Base feature.

- 21) Right-click **Front Plane** from the FeatureManager. This is your Sketch plane. The Context toolbar is displayed.
- 22) Click **Sketch** from the Context toolbar as illustrated.

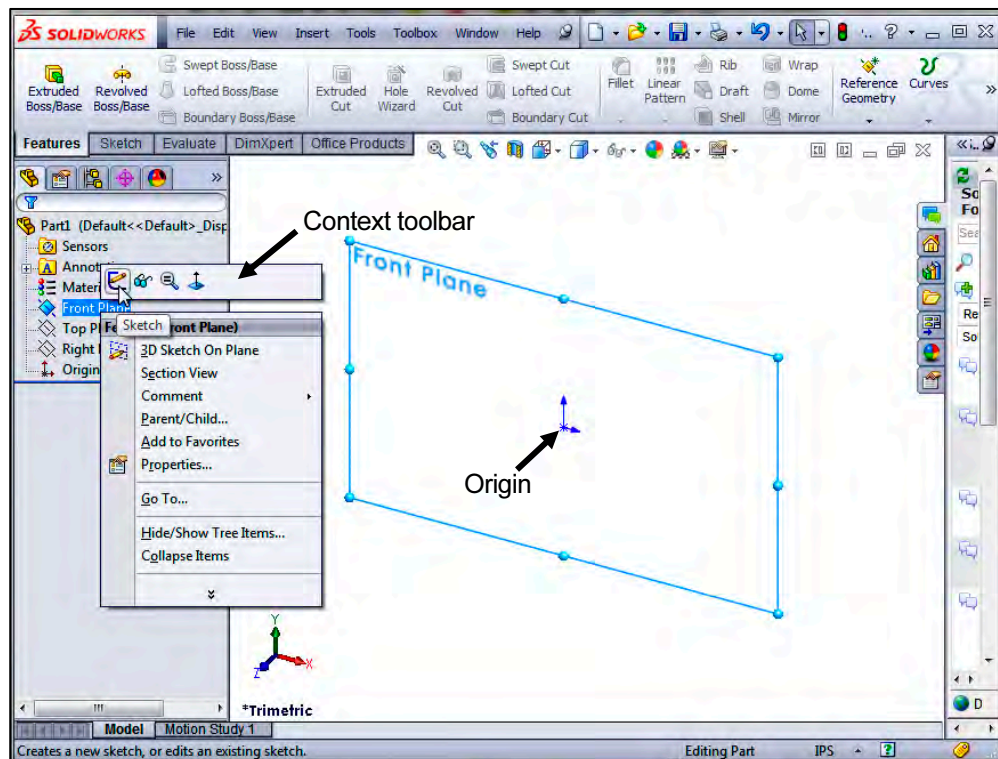

The Sketch toolbar is displayed. Front Plane is your Sketch plane. Note: the grid is deactivated for picture clarity.





You can also click the Front Plane from the FeatureManager and click the Sketch tab from the CommandManager.

**23)** Click the **Circle**  tool from the Sketch toolbar. The Circle PropertyManager is displayed.



The Circle-based tool uses a Consolidated Circle PropertyManager. The SolidWorks application defaults to the last used tool type.

**24)** Drag the **mouse pointer** into the Graphics window. The cursor displays the Circle icon symbol  .

**25)** Click the **Origin**  of the circle. The cursor displays the Coincident to point feedback symbol.

**26)** Drag the **mouse pointer** to the right of the Origin to create the circle as illustrated. The center point of the circle is positioned at the Origin.

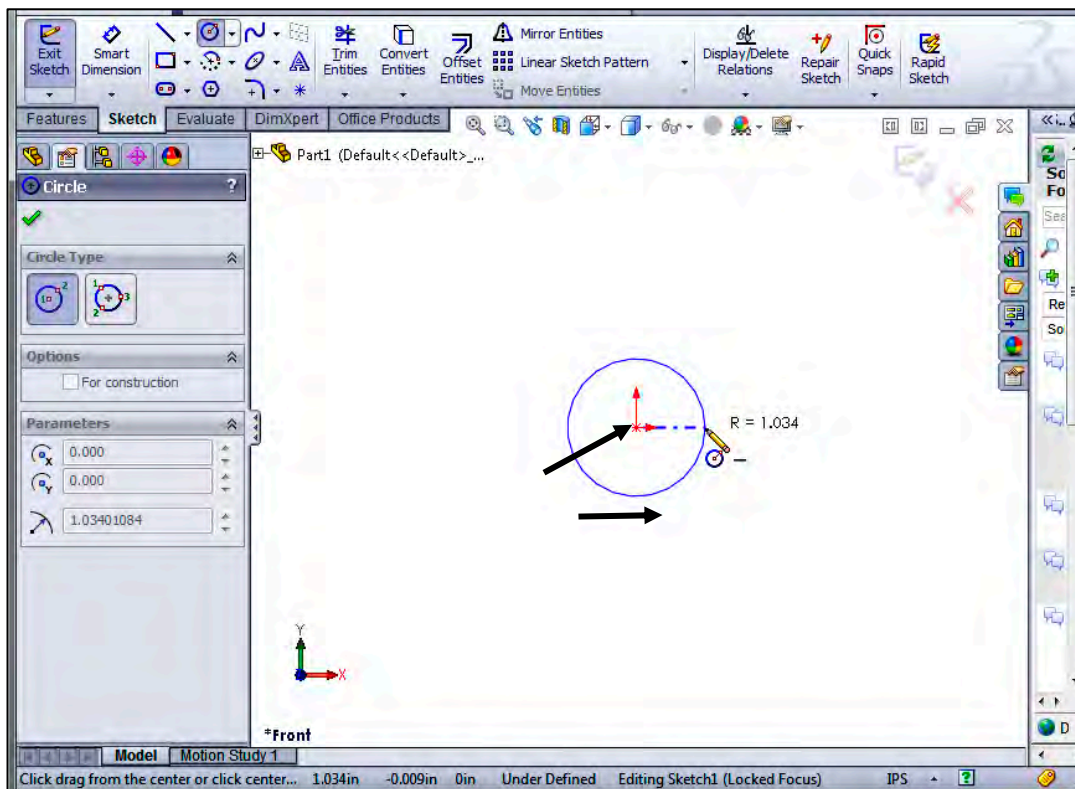
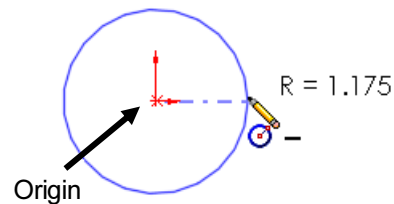

- 27) Click a **position** to create the circle. The activated circle is displayed in blue.

Add a dimension.

- 28) Click **Smart Dimension**  from the Sketch toolbar. The cursor displays the Smart Dimension icon



- 29) Click the **circumference** of the circle.
- 30) Click a **position** diagonally above the circle in the Graphics window.

- 31) Enter **.188in, [4.78]** in the Modify dialog box. Note The Dimension Modify dialog box provides the ability to select a unit drop-down menu to directly modify units in a sketch or feature from the document properties.

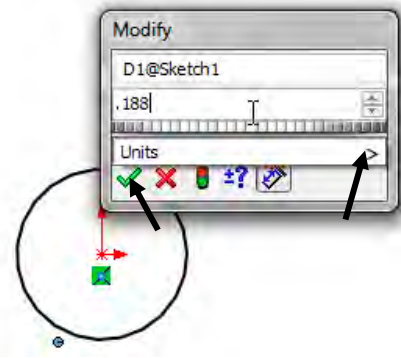

- 32) Click the **Green Check mark**  in the Modify dialog box. The diameter of the circle is .188 inches.

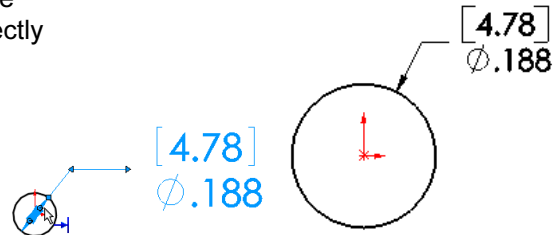

If required, click the blue arrow head dots to toggle the direction of the dimension arrow. The circular sketch is centered at the Origin. The dimension indicates the diameter of the circle.



Press the f key to fit the part document to the Graphics window.





Add relations, then dimensions. This keeps the user from having too many unnecessary dimensions. This also helps to show the design intent of the model. Dimension what geometry you intent to modify or adjust.

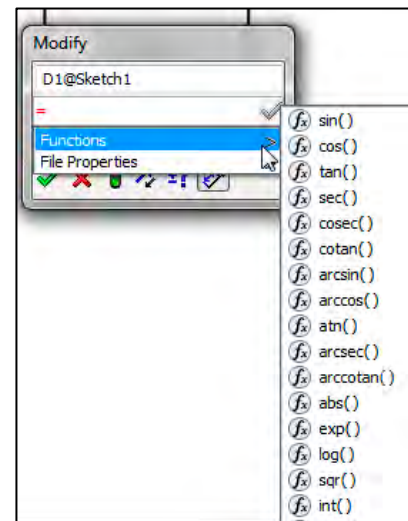
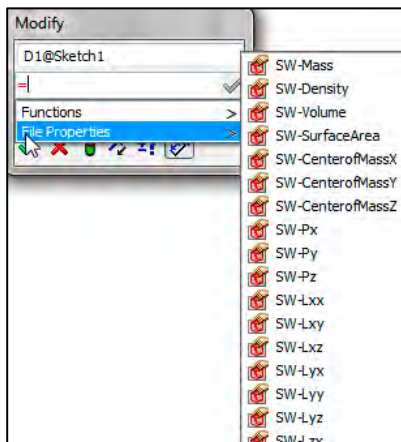

The Dimension Modify dialog box provides the ability to create an equation driven dimension relative to a function or File Property. See SolidWorks Help for additional detail information.



Extrude the sketch to create the Base Feature.

- 33) Click the **Features** tab from the CommandManager.
- 34) Click the **Extruded Boss/Base**  Features tool. The Boss-Extrude PropertyManager is displayed. Blind is the default End Condition in Direction 1.
- 35) Select **Mid Plane** for End Condition in Direction 1.
- 36) Enter **1.375in**, [34.93] for Depth in Direction 1. Accept the default conditions.
- 37) Click **OK**  from the Boss-Extrude PropertyManager. Boss-Extrude1 is displayed in the FeatureManager.

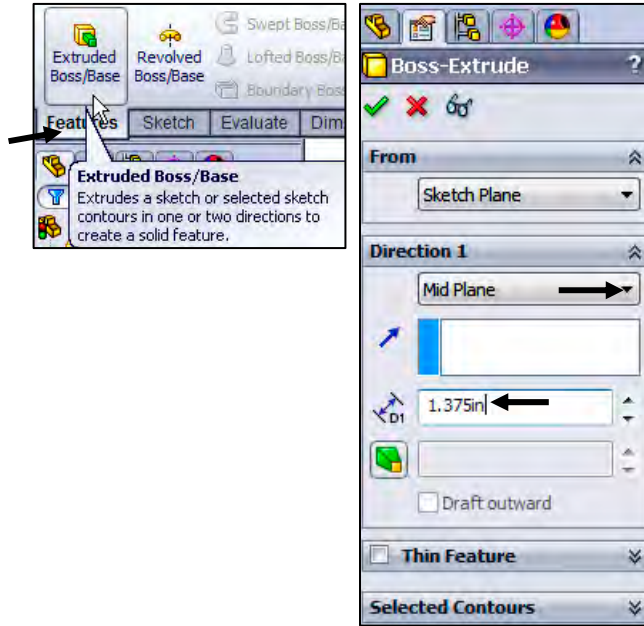

Fit the model to the Graphics window.

- 38) Press the **f** key. Note the location of the Origin in the model.



Use Symmetry. When possible and if it makes sense, model objects symmetrically about the origin.

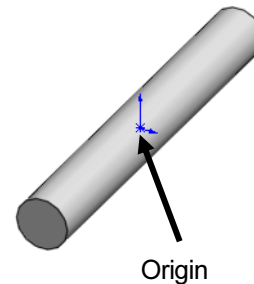
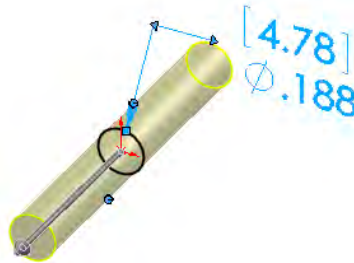

Rename a feature or sketch. Slowly click the feature or sketch name twice and enter the new name when the old one is highlighted.



Right-click anywhere on an extruded feature to set or modify the end condition from the shortcut menu. Click in empty space, on geometry, or on the handle. The shortcut menu provides options for Direction 1 and Direction 2. Note: Options are document dependent.



Display an Isometric view of the model. Press the **space bar** to display the Orientation dialog box. Click the **Isometric view**  icon.

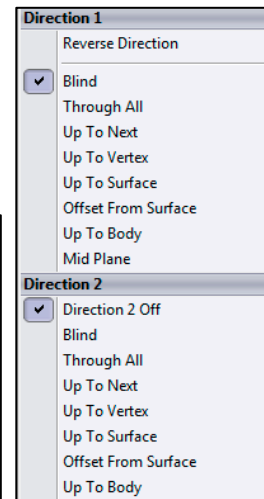
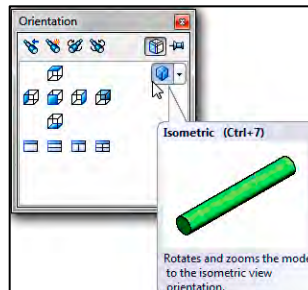

The Boss-Extrude PropertyManager displays the parameters utilized to define the feature. The Mid Plane End Condition in the Direction 1 box extrudes the sketch equally on both sides of the Sketch plane. The depth defines the extrude distance.

The Boss-Extrude1 feature name is displayed in the FeatureManager. The FeatureManager lists the features, planes, and other geometry that construct the part. Extrude features add material. Extrude features require the following: *Sketch Plane*, *Sketch* and *depth*.

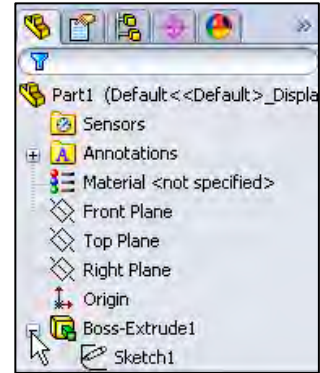

The Sketch plane is the Front Plane. The Sketch is a circle with the diameter of .188in, [4.76]. The Depth is 1.375in, [34.93].



For many features; (Extruded Boss/ Base, Extruded Cut, Simple Hole, Revolved Boss/Base, Revolved Cut, Fillet, Chamfer, Scale, Shell, Rib, Circular Pattern, Linear Pattern, Curve Driven Pattern, Revolved Surface, Extruded Surface, Fillet Surface, Edge Flange and Base Flange) you can enter and modify equations directly in the PropertyManager fields that allow numerical inputs. You can create equations with global variables, functions, and file properties without accessing the Equations, Global Variables and Dimensions dialog box.

For example, in the PropertyManager for the Extruded Boss/Base feature, you can enter equations in:

- Depth fields for Direction 1 and Direction 2
- Draft fields for Direction 1 and Direction 2
- Thickness fields for a Thin Feature with two direction types
- Offset Distance field

To create an equation in a numeric input field, start by entering = (equal sign). A drop-down list displays options for global variables, functions, and file properties. Numeric input fields that contain equations can display either the equation itself or its evaluated value. You can toggle between the equation and the value by clicking the Equations or Global Variable button that appears at the beginning of the field.

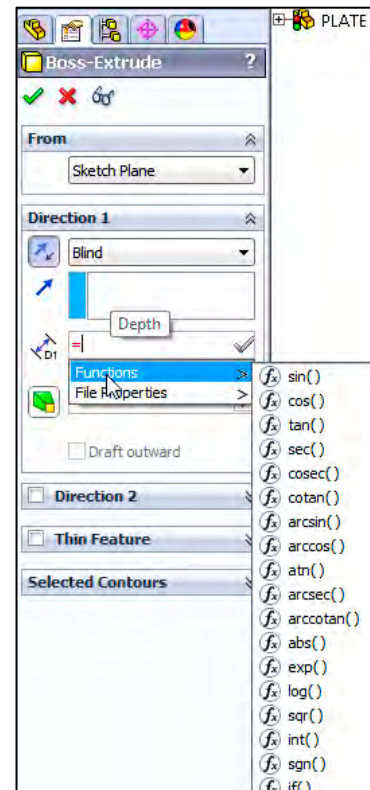

### Activity: AXLE Part-Save

Save the part.

- 39) Click **Save As** from the Drop-down Menu bar.
- 40) Click the **DOCUMENTS** file folder. Note: The procedure will be different depending on your Operating System.
- 41) Click **New Folder**.
- 42) Enter **SW-TUTORIAL-2013** for the file folder name. Note: In this book all models, assemblies and templates are saved to the SW-TUTORIAL-2013 folder.
- 43) Double-click the **SW-TUTORIAL-2013** file folder. SW-TUTORIAL-2013 is the Save in file folder name.
- 44) Enter **AXLE** for the File name.
- 45) Enter **AXLE ROD** for the Description.
- 46) Click **Save**. The AXLE FeatureManager is displayed.

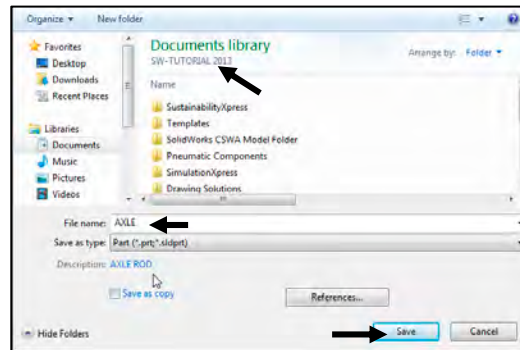
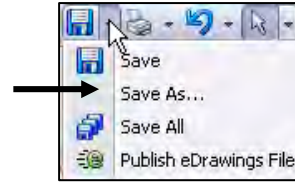

Organize parts into file folders. The file folder for this chapter is named: SW-TUTORIAL-2013. All documents for this book are saved in the SW-TUTORIAL-2013 file folder.





Copy all files from the DVD in the book to the created SW-TUTORIAL-2013 folder on your system.

### Activity: AXLE Part - Edit Appearance

Modify the color of the part.

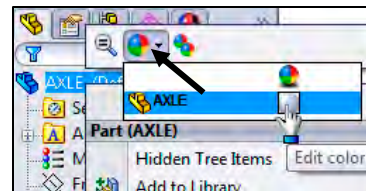
- 47) Right-click the **AXLE**  icon at the top of the FeatureManager.
- 48) Click the **Appearances** drop-down arrow.
- 49) Click the **Edit color** box as illustrated. The Color PropertyManager is displayed. AXLE is displayed in the Selection box.



- 50) Select a **light blue** color from the Color box. View your options.
- 51) Click **OK**  from the Color PropertyManager. View the AXLE in the Graphics window.

Use the Appearances PropertyManager to apply colors, material appearances, and transparency to parts and assembly components. For sketches or curves only, use the Sketch/Curve Color PropertyManager to apply colors.

 The Advanced tab includes the Illumination and Surface Finish tabs, and additional options in the Color/Image and Mapping tabs. To display the simplified Color/Image or Mapping interfaces, click the Basic tab.

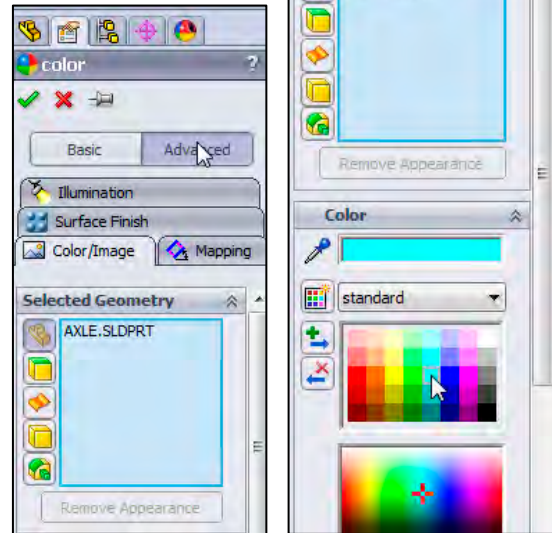

Sketching in SolidWorks is the basis for creating features. Features are the basis for creating parts, which can be put together into assemblies.

The sketch status appears in the window status bar and in the FeatureManager. Colors indicate the state of individual sketch entities. Sketches are generally in one of the following states:

- 1.) (+) *Over defined*. The sketch is displayed in red.
- 2.) (-) *Under defined*. The sketch is displayed in blue.
- 3.) *No prefix*. The sketch is fully defined. This is the ideal sketch state. A fully defined sketch has complete information (manufacturing and inspection) and is displayed in black.

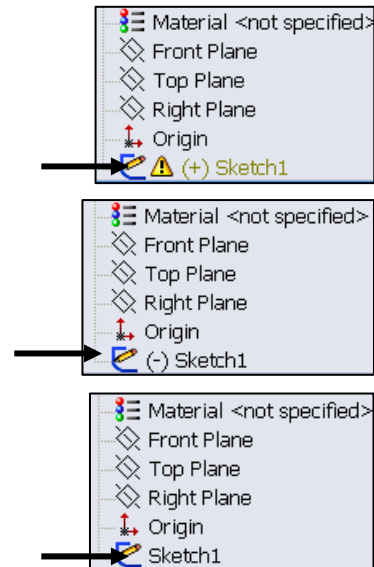

 The SketchXpert PropertyManager provides the ability to diagnose an over defined sketch to create a fully defined sketch. If you have an over defined sketch, click Over Defined at the bottom of the Graphics window toolbar. The SketchXpert PropertyManager is displayed. Click the Diagnose button.

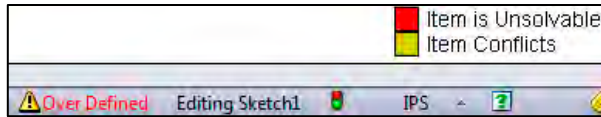

Select the desired solution and click the Accept button from the Results box.

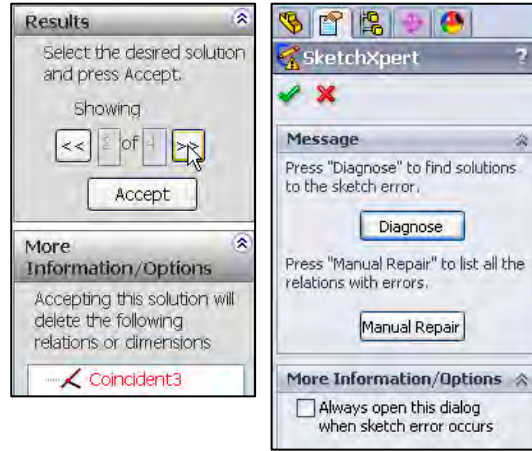



**Activity: AXLE Part-View Modes**

Orthographic projection is the process of projecting views onto Parallel planes with  $\perp$  projectors.

The default reference planes are the Front, Top and Right Planes.

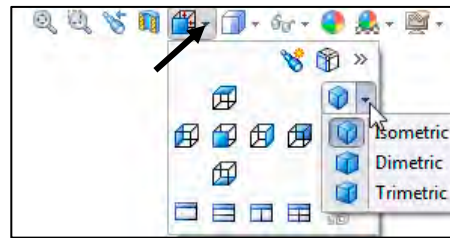
The Isometric view displays the part in 3D with two equal projection angles.



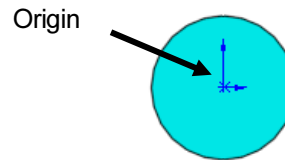

 The Heads-up View toolbar illustration may vary depending on your SolidWorks release version.



 Click **View, Origins** from the Menu bar menu to display the Origin in the Graphics window.

Display the various view modes using the Heads-up View toolbar.

- 52) Click **Front view**  from the Heads-up View toolbar.
- 53) Click **Top view**  from the Heads-up View toolbar.
- 54) Click **Right view**  from the Heads-up View toolbar.

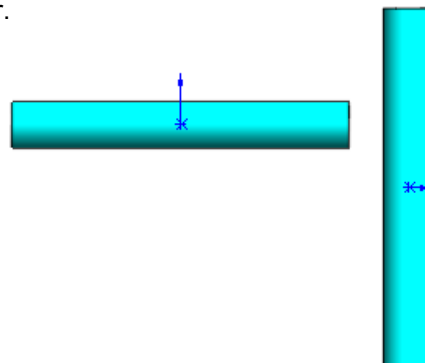



55) Click **Isometric view**  from the Heads-up View toolbar.



View modes manipulate the model in the Graphics window.

Display the various View modes.

56) Press the lower case **z** key to zoom out.

57) Press the upper case **Z** key to zoom in.

58) Click **Zoom to Fit**  to display the full size of the part in the current window.

59) **Right-click** in the Graphics window. View the available view tools.

60) Click **inside** the Graphics window.

Rotate the model.

61) Click the **middle mouse** button and move your mouse. The model rotates. The Rotate icon  is displayed.

62) Press the **up arrow** on your key board. The arrow keys rotate the model in 15 degree increments.



View modes remain active until deactivated from the View toolbar or unchecked from the pop-up menu.





Utilize the center wheel of the mouse to Zoom In/Zoom Out and Rotate the model in the Graphics window.



View the various Display Styles.

63) Click **Isometric view**  from the Heads-up View toolbar.

64) Click the **drop-down arrow** from the Display Styles box from the Heads-up Views toolbar as illustrated. SolidWorks provides five key Display Styles:

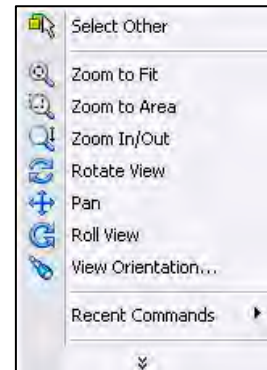
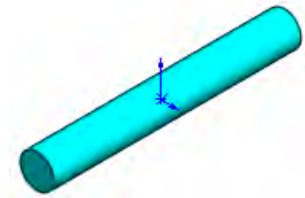
- *Shaded* . Displays a shaded view of the model with no edges.
- *Shaded With Edges* . Displays a shaded view of the model, with edges.



- *Hidden Lines Removed* . Displays only those model edges that can be seen from the current view orientation.
- *Hidden Lines Visible* . Displays all edges of the model. Edges that are hidden from the current view are displayed in a different color or font.
- *Wireframe* . Displays all edges of the model.

Save the AXLE part.

**65)** Click **Save** . The AXLE part is complete.



### Review the AXLE Part

The AXLE part utilized the Extruded Boss/Base feature. The Extruded Boss/Base feature adds material. The Extruded feature required a Sketch Plane, sketch and depth. The AXLE Sketch plane was the Front Plane. The 2D circle was sketched centered at the Origin. A dimension defined the overall size of the sketch based on the dimensions of mating parts in the LINKAGE assembly.

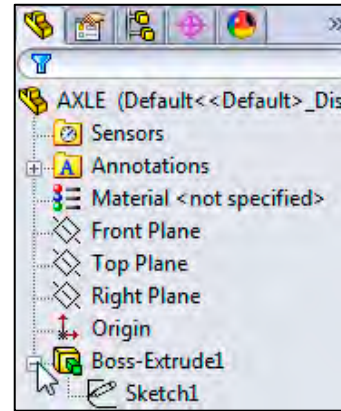

The default name of the Base feature is Boss-Extrude1. Boss-Extrude1 utilized the Mid Plane End Condition. The Boss-Extrude1 feature is symmetrical about the Front Plane.

The Edit Color option modified the part color. Select the Part icon in the FeatureManager to modify the color of the part. Color and a prefix define the sketch status. A blue sketch is under defined. A black sketch is fully defined. A red sketch is over defined.

The default Reference planes are the Front, Top, and Right Planes. Utilize the Heads-up View toolbar to display the principle views of a part. The View Orientation and Display Style tools manipulate the model in the Graphics windows.

 Instant3D provides the ability to click and drag geometry and dimension manipulator points to resize features in the Graphics window, and to use on-screen rulers to measure modifications. In this book, you will primarily use the PropertyManager and dialog boxes to create and modify model dimensions. Explore Instant3D as an exercise.

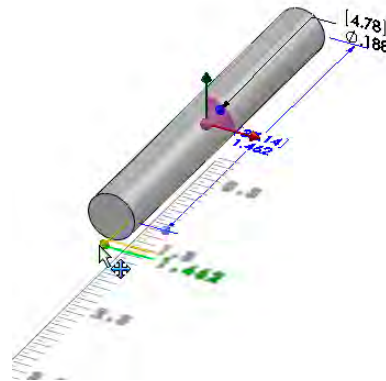

## SHAFT-COLLAR Part

The SHAFT-COLLAR part is a hardened steel ring fastened to the AXLE part.

Two SHAFT-COLLAR parts are used to position the two FLATBAR parts on the AXLE.

Create the SHAFT-COLLAR part.

Utilize the Extruded Boss/Base  feature. The Extruded Boss/Base feature requires a 2D circular profile.

Utilize symmetry. Sketch a circle on the Front Plane centered at the Origin.

Extrude the sketch with the Mid Plane End Condition. The Extruded Boss/Base feature (Boss-Extrude1) is centered on both sides of the Front Plane.

The Extruded Cut  feature removes material. Utilize an Extruded Cut feature to create a hole. The Extruded Cut feature requires a 2D circular profile. Sketch a circle on the front face centered at the Origin.

The Through All End Condition extends the Extruded Cut feature from the front face through all existing geometry.

 At this time, apply the Extruded Cut feature for a Through All hole vs. using the Hole Wizard. The book is design to expose the new user to various tools and design intents.

 You can also apply the Instant3D tool to create a Through All hole.

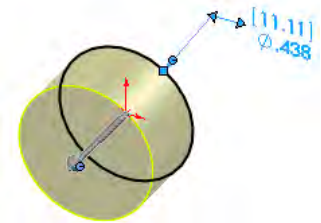
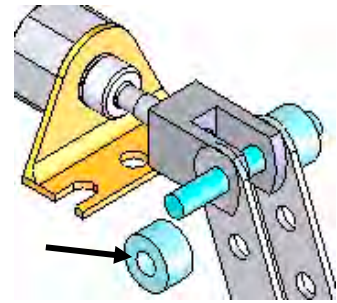

SHAFT-COLLAR

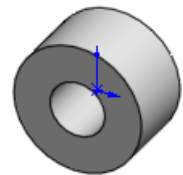

### Activity: SHAFT-COLLAR Part-Extruded Boss/Base Feature

Create a New part.

**66)** Click **New**  from the Menu bar. The New SolidWorks Document dialog box is displayed. The Templates tab is the default tab. Part is the default template from the New SolidWorks Document dialog box.

**67)** Double-click **Part**. The Part FeatureManager is displayed.

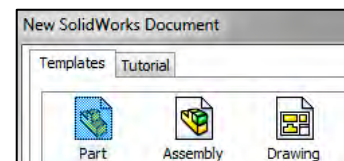

Save the part.

68) Click **Save As** from the drop-down Menu bar.

69) Enter **SHAFT-COLLAR** for File name in the SW-TUTORIAL-2013 folder.

70) Enter **SHAFT-COLLAR** for Description.

71) Click **Save**. The SHAFT-COLLAR FeatureManager is displayed.

Set the Dimension standard and part units.

72) Click **Options**, **Document Properties** tab from the Menu bar.

73) Select **ANSI** from the Overall drafting standard drop-down menu.

74) Click **Units**.

75) Click **IPS** (inch, pound, second), **[MMGS]** for Unit system.

76) Select **.123, [.12]** (three decimal places) for Length units Decimal places.

77) Select **None** for Angular units Decimal places.

78) Click **OK** from the Document Properties - Units dialog box.



To view the Origin, click **View, Origins** from the Menu bar menu.



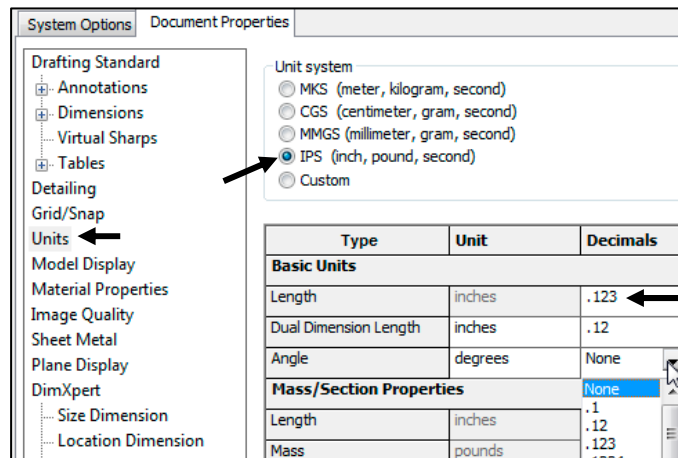
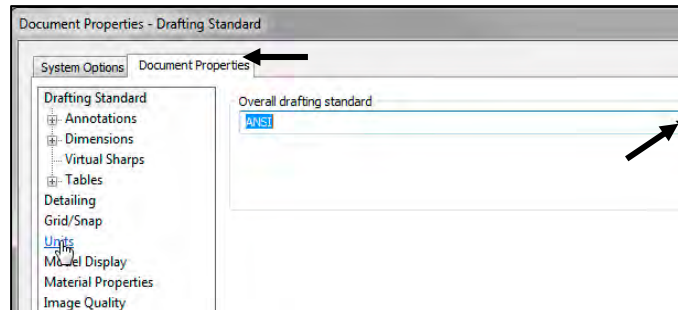
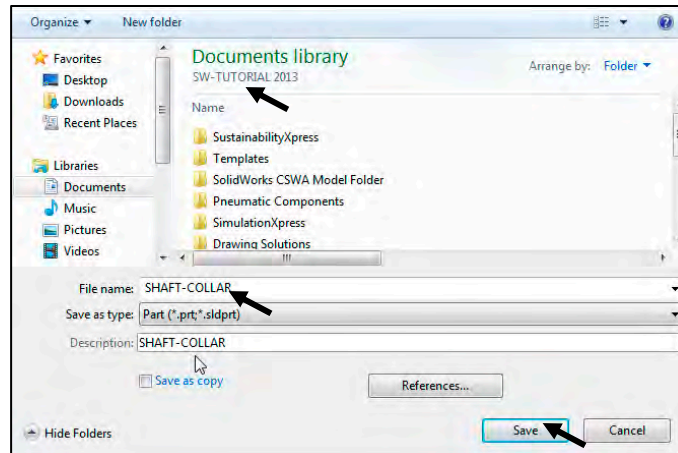
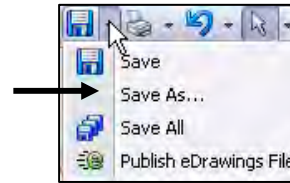

When you create a new part or assembly, the three default Planes (Front, Right and Top) are align with specific views. The Plane you select for the Base sketch determines the orientation of the part.



Insert a new sketch for the Extruded Base feature.

**79)** Right-click **Front Plane** from the FeatureManager. This is the Sketch plane. The Context toolbar is displayed.

**80)** Click **Sketch**  from the Context toolbar as illustrated. The Sketch toolbar is displayed.

**81)** Click the **Circle**  tool from the Sketch toolbar. The Circle PropertyManager is displayed. The cursor displays the Circle icon symbol .

**82)** Click the **Origin** . The cursor displays the Coincident to point feedback symbol.

**83)** Drag the **mouse pointer** to the right of the Origin as illustrated.

**84)** Click a **position** to create the circle.

Add a dimension.

**85)** Click **Smart Dimension**  from the Sketch toolbar.

**86)** Click the **circumference** of the circle. The cursor displays the diameter feedback symbol.

**87)** Click a **position** diagonally above the circle in the Graphics window.

**88)** Enter **.4375in**, [**11.11**] in the Modify dialog box.

**89)** Click the **Green Check mark**  in the Modify dialog box. The black sketch is fully defined.

Note: Three decimal places are displayed. The diameter value .4375 rounds to .438.

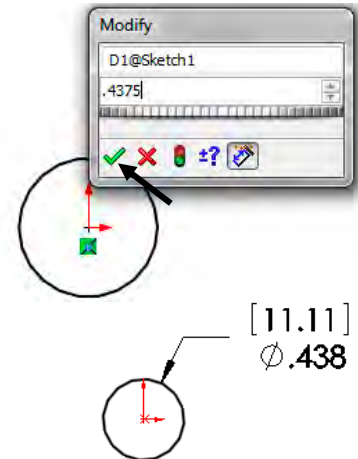
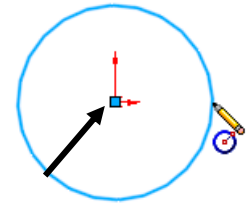
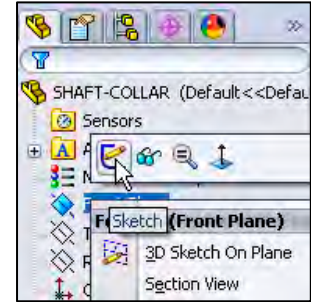

Extrude the sketch to create the Base feature.

**90)** Click the **Features** tab from the CommandManager.

**91)** Click the **Extruded Boss/Base**  features tool. The Boss-Extrude PropertyManager is displayed.

**92)** Select **Mid Plane** for End Condition in Direction 1.

**93)** Enter **.250in**, [**6.35**] for Depth. Accept the default conditions. Note the location of the Origin.

**94)** Click **OK**  from the Boss-Extrude PropertyManager. Boss-Extrude1 is displayed in the FeatureManager.

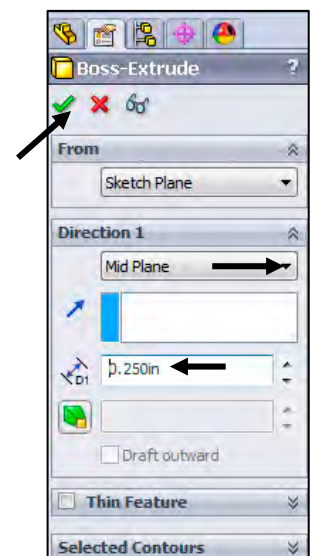
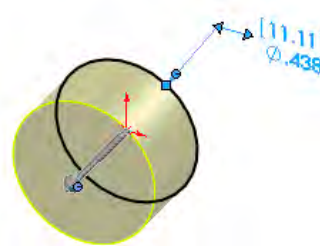

Fit the model to the Graphics window.

**95)** Press the **f** key.

**96)** Click **Trimetric**  from the Heads-Up View toolbar.

Save the model.

**97)** Click **Save** .

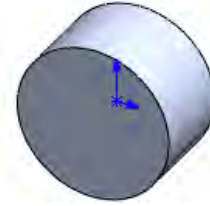

### Activity: SHAFT-COLLAR Part-Extruded Cut Feature

Insert a new sketch for the Extruded Cut feature.

**98)** Right-click the **front circular face** of the Boss-Extrude1 feature for the Sketch plane. The mouse pointer displays the face

feedback  icon.



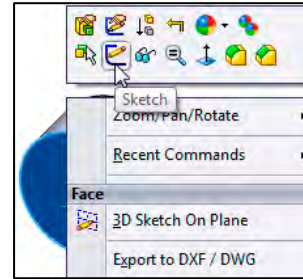

View the mouse pointer feedback icon for the correct geometry: line, face, point or vertex.



**99)** Click **Sketch**  from the Context toolbar as illustrated. The Sketch toolbar is displayed. This is your Sketch plane!

**100)** Click **Hidden Lines Removed**  from the Heads-up View toolbar.

**101)** Click the **Circle**  tool from the Sketch toolbar. The Circle PropertyManager is displayed. The cursor

displays the Circle icon symbol .

**102)** Click the red **Origin** . The cursor displays the Coincident to point feedback symbol.

**103)** Drag the **mouse pointer** to the right of the Origin.

**104)** Click a **position** to create the circle as illustrated.

Add a dimension.

**105)** Click the **Smart Dimension**  Sketch tool.

**106)** Click the **circumference** of the circle.

**107)** Click a **position** diagonally above the circle in the Graphics window.

**108)** Enter **.190in**, [4.83] in the Modify dialog box.

**109)** Click the **Green Check mark**  in the Modify dialog box.

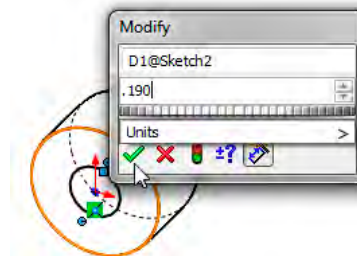
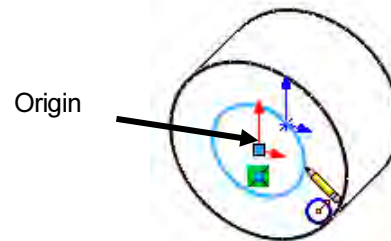
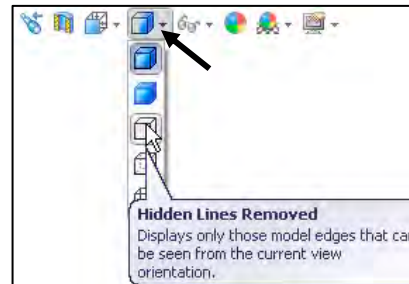



Insert an Extruded Cut feature.

**110)** Click the **Features** tab from the CommandManager.

**111)** Click **Extruded Cut**  from the Features toolbar. The Cut-Extrude PropertyManager is displayed.

**112)** Select **Through All** for End Condition in Direction 1. The direction arrow points to the back. If needed, click the Reverse Direction button. Accept the default conditions.

**113)** Click **OK**  from the Cut-Extrude PropertyManager. Cut-Extrude1 is displayed in the FeatureManager.

 The Extruded Cut feature is named Cut-Extrude1. The Through All End Condition removes material from the Front Plane through the Boss-Extrude1 geometry.

 Model about the origin; this provides a point of reference.

 Press the **spacebar** to activate the Orientation dialog box.

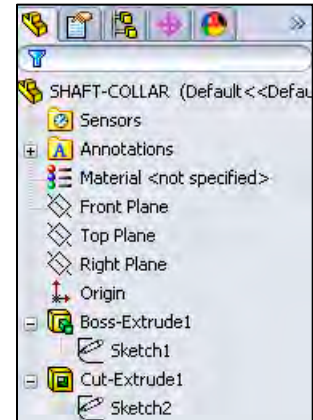
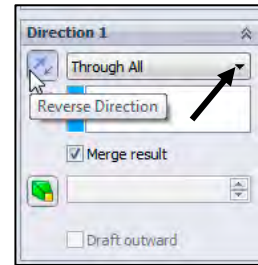
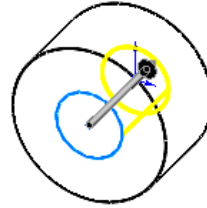

### Activity: SHAFT-COLLAR-Modify Dimensions and Edit Color

Modify the dimensions.

**114)** Click **Trimetric view**  from the Heads-up View toolbar.

**115)** Click the **z** key a few times to Zoom in.

**116)** Double-click the **outside cylindrical face** of the SHAFT-COLLAR. The Boss-Extrude1 dimensions are displayed. Sketch dimensions are displayed in black. The Extrude depth dimensions are displayed in blue.

**117)** Double-click the **.250in, [6.35]** depth dimension.

**118)** Enter **.500in, [12.70]**.

**119)** Click **Rebuild**  from the Menu bar.

The Boss-Extrude1 feature and Cut-Extrude1 feature are modified.

Return to the original dimensions.

**120)** Click the **Undo**  tool from the Menu bar.

**121)** Click **Shaded With Edges**  from the Heads-up View toolbar.

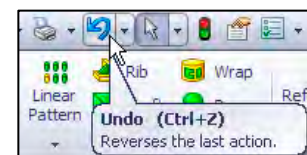
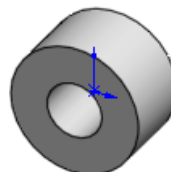
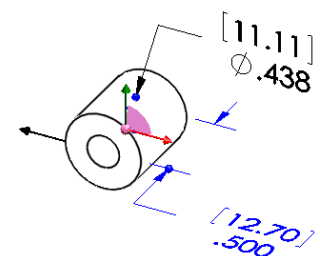
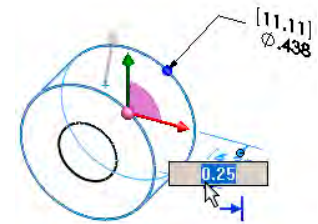

Modify the part color.

**122)** Right-click the **SHAFT-COLLAR Part**  SHAFT-COLLAR icon at the top of the FeatureManager.

**123)** Click the **Appearances** drop-down arrow.

**124)** Click the **Edit color** box as illustrated. The Color PropertyManager is displayed. SHAFT-COLLAR is displayed in the Selection box.

**125)** Select a **light green** color from the Color box.

**126)** Click **OK**  from the Color PropertyManager. View the SHAFT-COLLAR in the Graphics window.

Save the SHAFT-COLLAR part.

**127)** Click **Save** . The SHAFT-COLLAR part is complete. Note: all sketches are and should be fully defined.

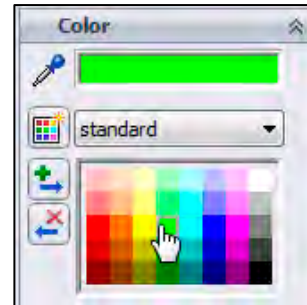
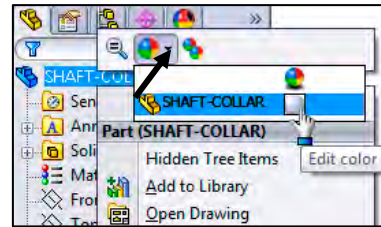

## Review the SHAFT-COLLAR Part

The SHAFT-COLLAR utilized an Extruded Boss/Base  feature. The Extruded Boss/Base feature adds material. An Extruded feature required a Sketch Plane, sketch and depth.

The Sketch plane was the Front Plane. The 2D circle was sketched centered at the Origin. A dimension fully defined the overall size of the sketch. The default name of the feature was Boss-Extrude1. Boss-Extrude1 utilized the Mid Plane End Condition. The Boss-Extrude1 feature was symmetric about the Front Plane.

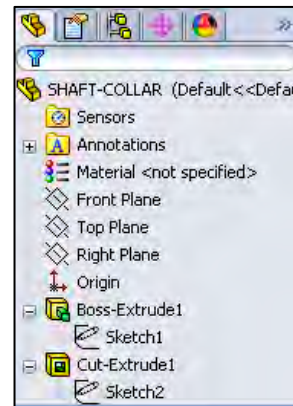

The Extruded Cut  feature removed material to create the hole. The Extruded Cut feature default named was Cut-Extrude1. The Through All End Condition option created the Cut-Extrude1 feature. Feature dimensions were modified. The Edit Color option was utilized to modify the part color.



Click **Options**, **Document Properties** tab, **Dimension** and click the **Smart** box to have the dimension leader arrow head point inwards for ANSI.

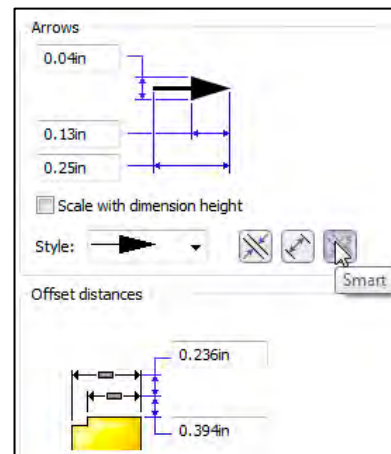



**FLATBAR Part**

The FLATBAR part fastens to the AXLE. The FLATBAR contains nine,  $\varnothing.190$ in holes spaced 0.5in apart.

The FLATBAR part is manufactured from .090inch 6061 alloy.

Create the FLATBAR part. Utilize the new Straight Slot Sketch tool with an Extruded Boss/Base feature. The Extruded feature requires a 2D profile sketched on the Front Plane.

The Straight Slot Sketch tool automatically applies design symmetry, (Midpoint and Equal geometric relations). Create the 2D profile centered about the Origin. Relations control the size and position of entities with constraints.

Utilize an Extruded Cut feature to create the first hole. This is the seed feature for the Linear Pattern.

Utilize a Linear Pattern feature to create the remaining holes. A Linear Pattern creates an array of features in a specified direction.



Add relations, then dimensions. This keeps the user from having too many unnecessary dimensions. This also helps to show the design intent of the model. Dimension what geometry you intent to modify or adjust.

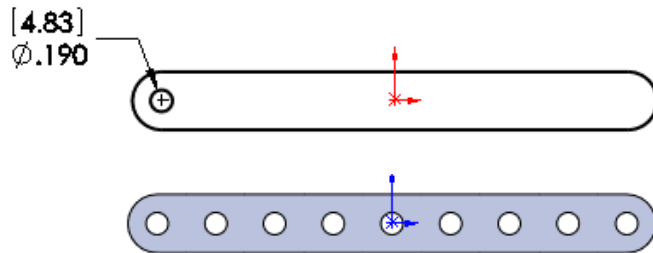
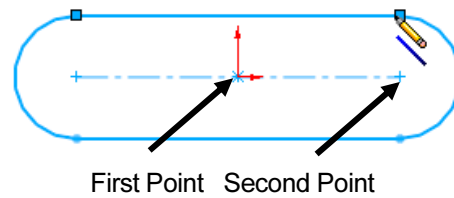
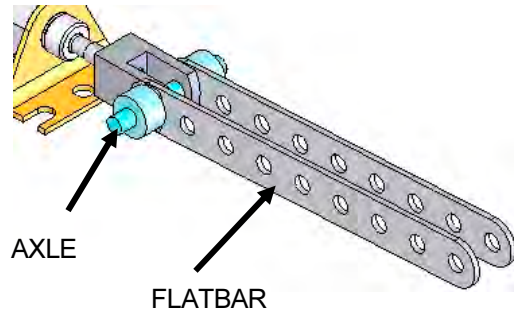

**Activity: FLATBAR Part-Extruded Base Feature**

Create a New part.

**128)** Click **New** from the Menu bar. The New SolidWorks Document dialog box is displayed. The Templates tab is the default tab. Part is the default template from the New SolidWorks Document dialog box.

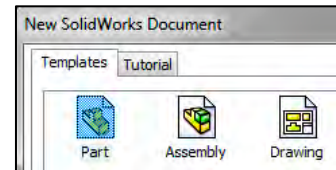

**129)** Double-click **Part**. The Part FeatureManager is displayed.

Save the part.

**130)** Click **Save As** from the drop-down Menu bar.

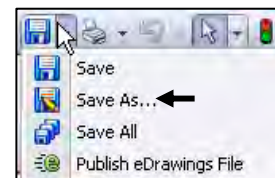

131) Enter **FLATBAR** for File name in the SW-TUTORIAL-2013 folder

132) Enter **FLAT BAR 9 HOLES** for Description.

133) Click **Save**. The FLATBAR FeatureManager is displayed.

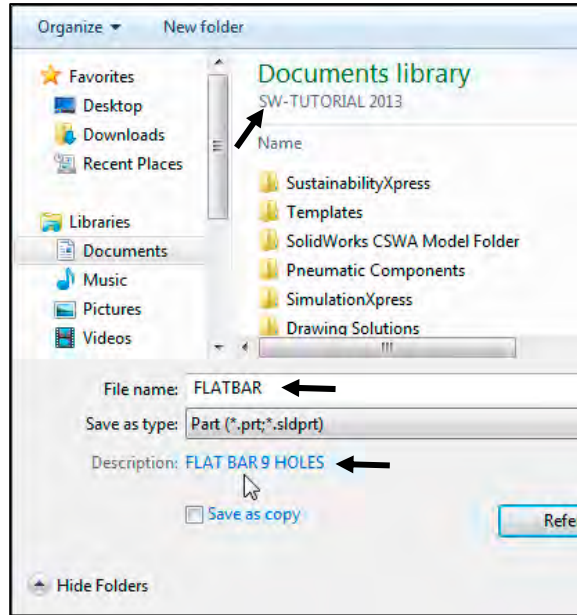

Set the Dimension standard and part units.

134) Click **Options**, **Document Properties** tab from the Menu bar.

135) Select **ANSI** from the Overall drafting standard drop-down menu.

136) Click **Units**.

137) Click **IPS**, **[MMGS]** for Unit system.

138) Select **.123**, **[.12]** for Length units Decimal places.

139) Select **None** for Angular units Decimal places.

140) Click **OK** to set the document units.

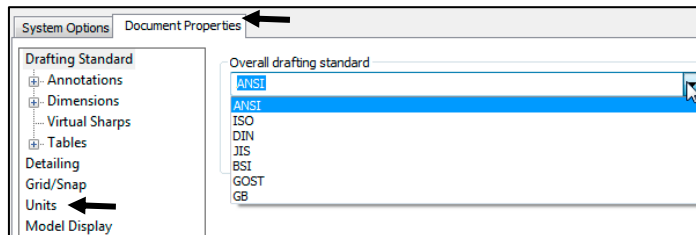

Insert a new sketch for the Extruded Base feature.

141) Right-click **Front Plane** from the FeatureManager. This is the Sketch plane.

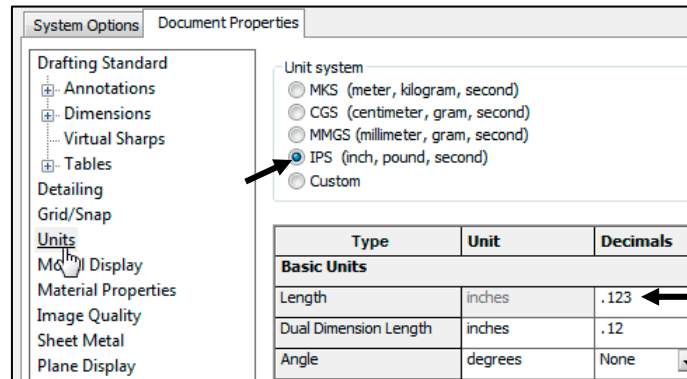

142) Click **Sketch** from the Context toolbar as illustrated. The Sketch toolbar is displayed.

Utilize the Consolidated Slot Sketch toolbar. Apply the Centerpoint Straight Slot Sketch tool. The Straight Slot Sketch tool provides the ability to sketch a straight slot from a center point. In this example, use the origin as your center point.

143) Click the **Centerpoint Straight Slot** tool from the Sketch toolbar. The Slot PropertyManager is displayed.

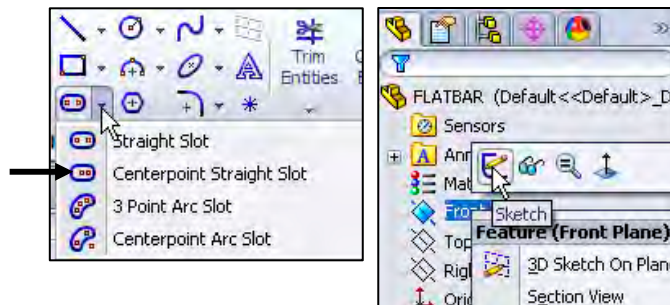

Create the Straight Slot with three points.

**144)** Click the **Origin**. This is your first point.

**145)** Click a **point** directly to the right of the Origin. This is your second point.

**146)** Click a **point** directly above the second point. This is your third point. The Straight Slot is displayed.

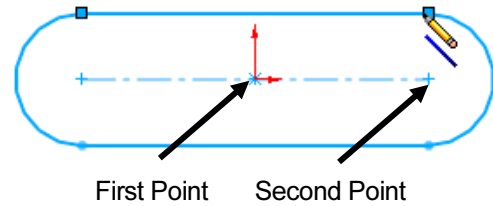

**147)** Click **OK** from the Slot PropertyManager

View the Sketch relations.

**148)** Click **View, Sketch Relations** from the Menu bar menu. View the sketch relations in the Graphics window.

Deactivate the Sketch relations.

**149)** Click **View**; uncheck **Sketch Relations** from the Menu bar. The Straight Slot Sketch tool provides a midpoint relation with the Origin and Equal relations between the other sketch entities.

Add a dimension.

**150)** Click the **Smart Dimension** tool from the Sketch toolbar.

**151)** Click the **horizontal centerline**.

**152)** Click a **position** above the top horizontal line in the Graphics window.

**153)** Enter **4.000in**, [**101.6**] in the Modify dialog box.

**154)** Click the **Green Check mark** in the Modify dialog box.

**155)** Click the **right arc** of the FLATBAR.

**156)** Click a **position** diagonally to the right in the Graphics window.

**157)** Enter **.250in**, [**6.35**] in the Modify dialog box.

**158)** Click the **Green Check mark** in the Modify dialog box. The black sketch is fully defined.

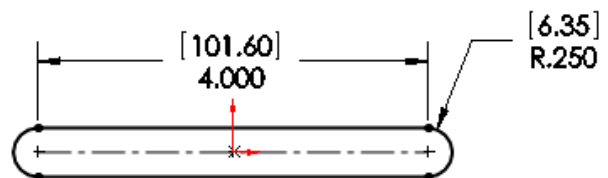
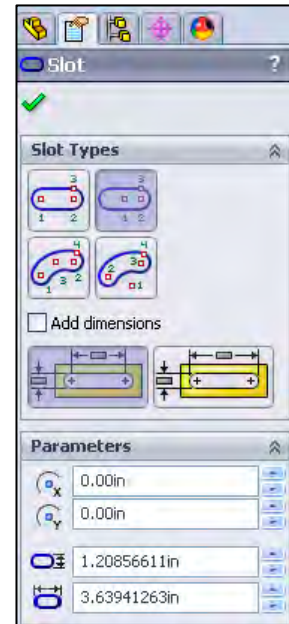

**Model about the Origin:** This provides a point of reference for your dimensions to fully define the sketch.

It's considered best practice to fully define all sketches in the model. However; there are times when this is not practical. Generally when using the Spline tool to create a freeform shape.

Extrude the sketch to create the Base (Boss-Extrude1) feature.

**159)** Click **Extruded Boss/Base**  from the Features toolbar. The Boss-Extrude PropertyManager is displayed.

**160)** Enter **.090in**, [2.29] for Depth. Accept the default conditions.

**161)** Click **OK**  from the Boss-Extrude PropertyManager. Boss-Extrude1 is displayed in the FeatureManager.

Fit the model to the Graphics window.

**162)** Press the **f** key.

Save the FLATBAR part.

**163)** Click **Save** .

 Click **View, Origins** from the Menu bar menu to display the Origin in the Graphics window.

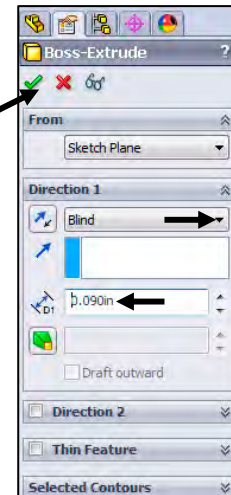
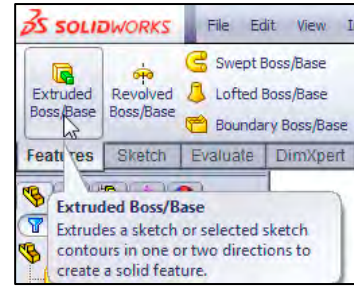
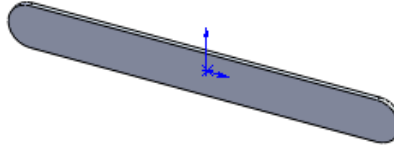

### Activity: FLATBAR Part-Extruded Cut Feature

Insert a new sketch for the Extruded Cut Feature.

**164)** Right-click the **front face** of the Boss-Extrude1 feature in the Graphics window. This is the Sketch plane. Boss-Extrude1 is highlighted in the FeatureManager.

**165)** Click **Sketch**  from the Context toolbar as illustrated. The Sketch toolbar is displayed.

Display the Front view.

**166)** Click **Front view**  from the Heads-up View toolbar.

**167)** Click **Hidden Lines Removed**  from the Heads-up View toolbar.

The process of placing the mouse pointer over an existing arc to locate its center point is called “wake up”.

 Rename a feature or sketch for clarity. Slowly click the feature or sketch name twice and enter the new name when the old one is highlighted.

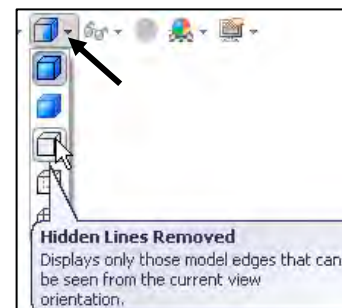
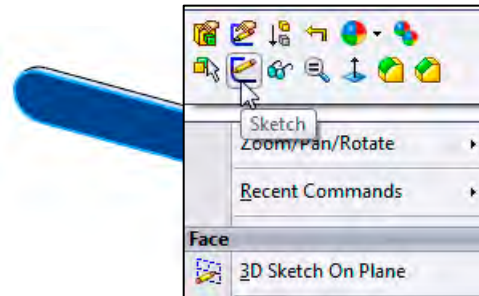

Wake up the Center point.

**168)** Click the **Circle**  Sketch tool from the Sketch toolbar. The Circle PropertyManager is displayed.

**169)** Place the **mouse pointer** on the left arc. Do not click. The center point of the slot arc is displayed.

**170)** Click the **center point** of the arc.

**171)** Click a **position** to the right of the center point to create the circle as illustrated.

Add a dimension.

**172)** Click the **Smart Dimension**  Sketch tool.

**173)** Click the **circumference** of the circle.

**174)** Click a **position** diagonally above and to the left of the circle in the Graphics window.

**175)** Enter **.190in**, **[4.83]** in the Modify box.

**176)** Click the **Green Check mark**  in the Modify dialog box.

**177)** Click **Isometric view**  from the Heads-up View toolbar.

**178)** Click **Shaded With Edges**  from the Heads-up View toolbar.

Insert an Extruded Cut feature.

**179)** Click the **Features** tab from the CommandManager.

**180)** Click **Extruded Cut**  from the Features toolbar. The Cut- Extrude PropertyManager is displayed.

**181)** Select **Through All** for End Condition in Direction 1. The direction arrow points to the back. Accept the default conditions.

**182)** Click **OK**  from the Cut-Extrude PropertyManager. The Cut-Extrude1 feature is displayed in the FeatureManager.

Save the FLATBAR part.

**183)** Click **Save** .

 Think design intent. When do you use various End Conditions? What are you trying to do with the design? How does the component fit into an Assembly?

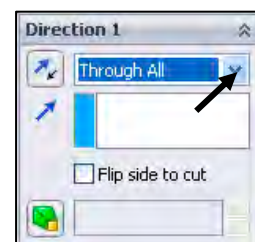
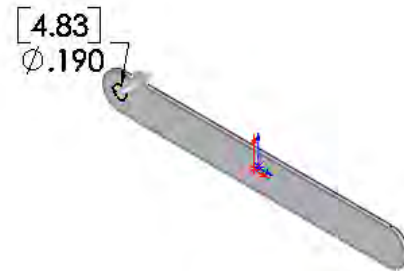
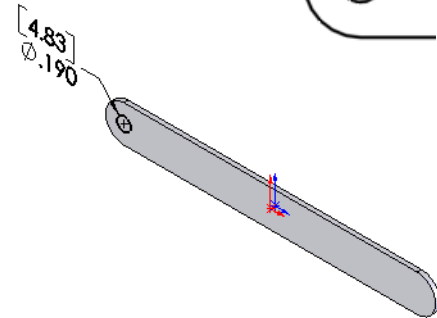
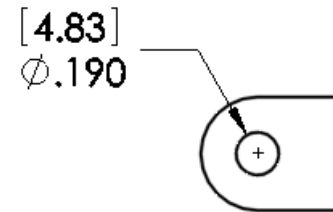
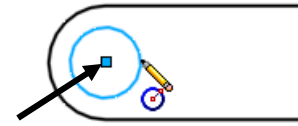
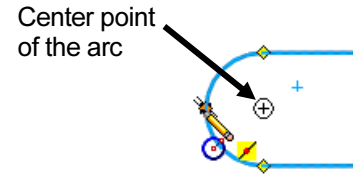

The blue Cut-Extrude1 icon indicates that the feature is selected.

Select features by clicking their icons in the FeatureManager or by selecting their geometry in the Graphics window.



When you create a new part or assembly, the three default Planes (Front, Right and Top) are align with specific views. The Plane you select for the Base sketch determines the orientation of the part.

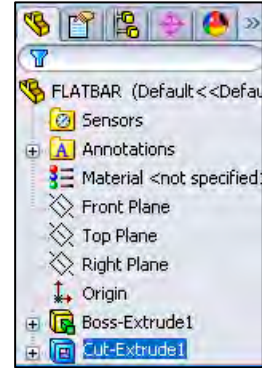

### Activity: FLATBAR Part-Linear Pattern Feature

Create a Linear Pattern feature.

**184)** Click the **Linear Pattern**  tool from the Features toolbar. The Linear Pattern PropertyManager is displayed. Cut-Extrude1 is displayed in the Features to Pattern box. Note: If Cut-Extrude1 is not displayed, click inside the Features to Pattern box. Click Cut-Extrude1 from the fly-out FeatureManager.

**185)** Click the **top edge** of the Boss-Extrude1 feature for Direction1 in the Graphics window. Edge<1> is displayed in the Pattern Direction box.

**186)** Enter **0.5in**, [**12.70**] for Spacing.

**187)** Enter **9** for Number of Instances. Instances are the number of occurrences of a feature.

**188)** The Direction arrow points to the right. Click the **Reverse Direction**  button if required.

**189)** Check **Geometry Pattern** from the Options box.

**190)** Click **OK**  from the Linear Pattern PropertyManager. The LPattern1 feature is displayed in the FeatureManager.



Design Intent is how your part reacts as parameters are modified. Example: If you have a hole in a part that must always be  $.125 \leq$  from an edge, you would dimension to the edge rather than to another point on the sketch. As the part size is modified, the hole location remains  $.125 \leq$  from the edge.

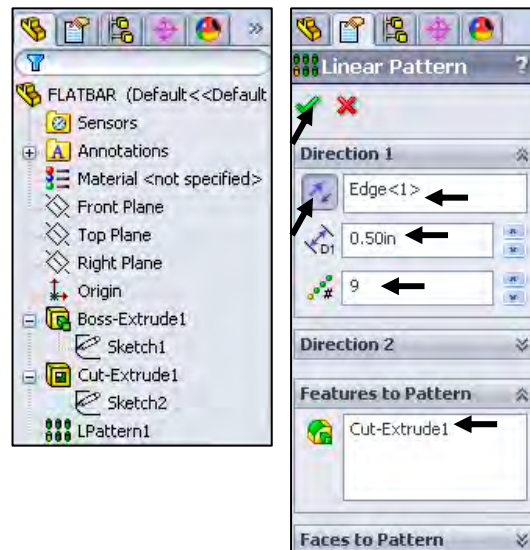
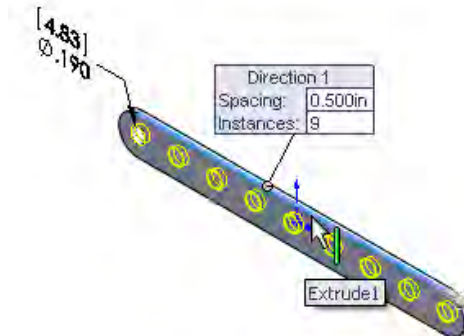

Save the FLATBAR part.

**191)** Click **Save** . The FLATBAR part is complete.

Close all documents.

**192)** Click **Windows, Close All** from the Menu bar.

 To remove Tangent edges, click **Display/Selections** from the Options menu, check the **Removed** box.

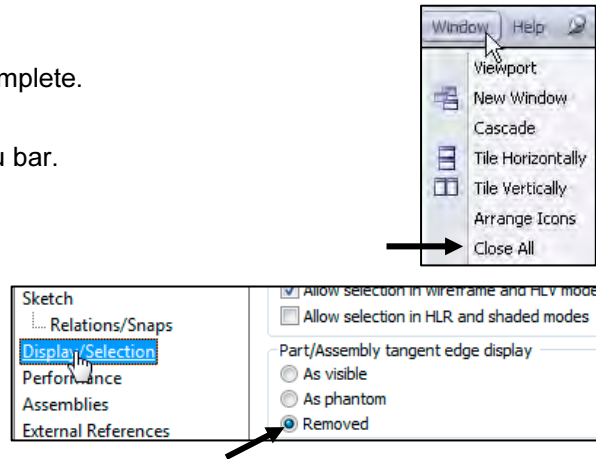

### Review the FLATBAR Part

The FLATBAR part utilized an Extruded Boss/Base  feature as the first feature. The Sketch plane was the Front Plane. The 2D sketch utilized the Straight Slot Sketch tool to create the slot profile.

You added linear and radial dimensions to define your sketch. You applied the Extruded Boss/Base feature with a Blind End Condition in Direction 1. Boss-Extrude1 was created.

You created a circle sketch for the Extruded Cut feature on the front face of Boss-Extrude1. The front face was your Sketch plane for the Extruded Cut feature. The Extruded Cut  feature removed material to create the hole. The Extruded Cut feature default name was Cut-Extrude1. The Through All End Condition option in Direction 1 created the Cut-Extrude1 feature. The Cut-Extrude1 feature is the seed feature for the Linear Pattern of holes.

The Linear Pattern  feature created an array of 9 holes, equally spaced along the length of the FLATBAR part.

## LINKAGE Assembly

An assembly is a document that contains two or more parts. An assembly inserted into another assembly is called a sub-assembly. A part or sub-assembly inserted into an assembly is called a component. The LINKAGE assembly consists of the following components: AXLE, SHAFT-COLLAR, FLATBAR and AirCylinder sub-assembly.

Establishing the correct component relationship in an assembly requires forethought on component interaction. Mates are geometric relationships that align and fit components in an assembly. Mates remove degrees of freedom from a component.

## Mate Types

Mates reflect the physical behavior of a component in an assembly. The components in the LINKAGE assembly utilize Standard mate types. Review *Standard*, *Advanced* and *Mechanical* mate types.

### Standard Mates:

Components are assembled with various mate types. The Standard mate types are:

**Coincident Mate:** Locates the selected faces, edges, or planes so they use the same infinite line. A Coincident mate positions two vertices for contact

**Parallel Mate:** Locates the selected items to lie in the same direction and to remain a constant distance apart.

**Perpendicular Mate:** Locates the selected items at a 90 degree angle to each other.

**Tangent Mate:** Locates the selected items in a tangent mate. At least one selected item must be either a conical, cylindrical, spherical face.

**Concentric Mate:** Locates the selected items so they can share the same center point.

**Lock Mate:** Maintains the position and orientation between two components.

**Distance Mate:** Locates the selected items with a specified distance between them. Use the drop-down arrow box or enter the distance value directly.

**Angle Mate:** Locates the selected items at the specified angle to each other. Use the drop-down arrow box or enter the angle value directly.

There are two Mate Alignment options. The Aligned option positions the components so that the normal vectors from the selected faces point in the same direction. The Anti-Aligned option positions the components so that the normal vectors from the selected faces point in opposite directions.

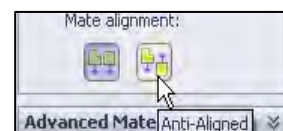
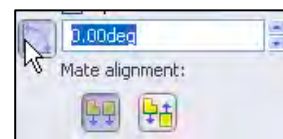
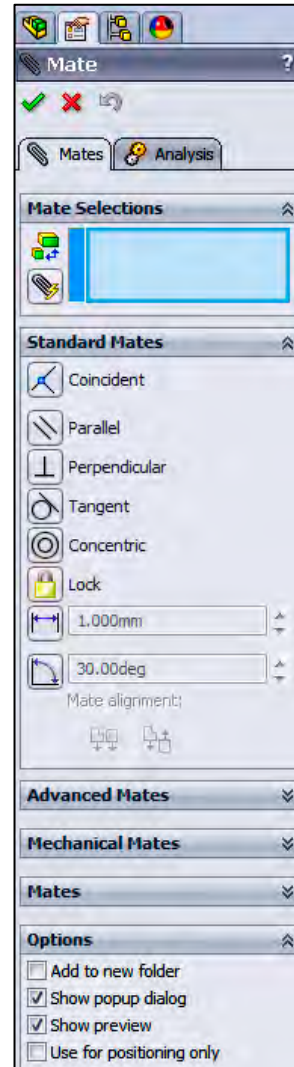





Mates define the allowable degrees of freedom in an assembly. There are six degrees of freedom: 3 translational and 3 rotational.

### Advanced Mates:

The Advanced mate types are:

**Symmetric Mate:** Positions two selected entities to be symmetric about a plane or planar face. A Symmetric Mate does not create a Mirrored Component.

**Width Mate:** Centers a tab within the width of a groove.

**Path Mate:** Constrains a selected point on a component to a path.

**Linear/Linear Coupler Mate:** Establishes a relationship between the translation of one component and the translation of another component.

**Distance Mate:** Locates the selected items with a specified distance between them. Use the drop-down arrow box or enter the distance value directly.

**Angle Mate:** Locates the selected items at the specified angle to each other. Use the drop-down arrow box or enter the angle value directly.

### Mechanical Mates:

The Mechanical mate types are:

**Cam Mate:** Forces a plane, cylinder, or point to be tangent or coincident to a series of tangent extruded faces.

**Hinge Mate:** Limits the movement between two components to one rotational degree of freedom.

**Gear Mate:** Forces two components to rotate relative to one another around selected axes.

**Rack Pinion Mate:** Provides the ability to have Linear translation of a part, rack causes circular rotation in another part, pinion, and vice versa.

**Screw Mate:** Constrains two components to be concentric, and adds a pitch relationship between the rotation of one component and the translation of the other.

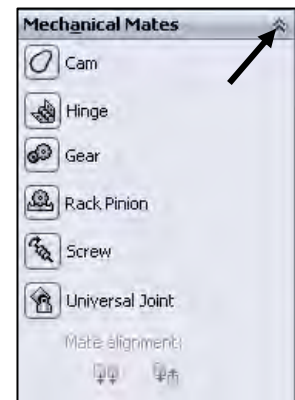
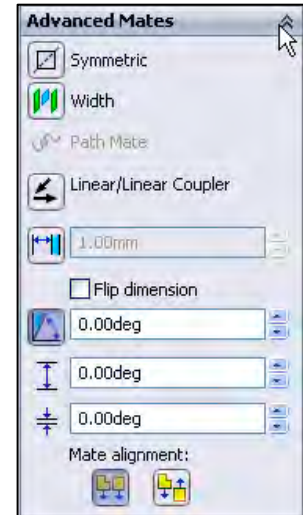

**Universal Joint Mate:** The rotation of one component (the output shaft) about its axis is driven by the rotation of another component (the input shaft) about its axis.

Example: Utilize a Concentric mate between the AXLE cylindrical face and the FLATBAR Extruded Cut feature, (hole). Utilize a Coincident mate between the SHAFT-COLLAR back face and the FLATBAR front flat face.

The LINKAGE assembly requires the AirCylinder assembly. The AirCylinder assembly is located on the SolidWorks Tutorial DVD in the Pneumatic Components folder.

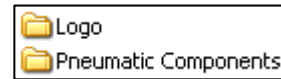

### Activity: AirCylinder Assembly-Open and Save As option

Copy the folders and files from the DVD in the book.

**193) Minimize** the SolidWorks Graphics window.

**194) Insert** the DVD from the book into your computer. If required, **exit** out of AutoPlay for the Video Instruction.

**195) Click Open folder to view files.** View the available folders.

**196) Copy** the folders and files from the DVD to your SW-TUTORIAL-2013 folder on the hard drive. If needed create the SW-TUTORIAL-2013 folder on your hard drive.

Return to SolidWorks. Create a new assembly.

**197) Maximize** the SolidWorks Graphics window.

**198) Click New**  from the Menu bar. The New SolidWorks Document dialog box is displayed. The Templates tab is the default tab.

**199) Double-click Assembly** from the New SolidWorks Document dialog box. The Begin Assembly PropertyManager is displayed.

**200) Click the Browse** button. Browse to the **SW-TUTORIAL-2013/Pneumatic Components** folder. Note: Open models are displayed in the Open documents box.

**201) Click the Filter Assemblies (\*.asm;\*.sldasm)** button in the Open dialog box to view assembly documents.

**202) Double-click the AirCylinder** assembly from the SW-TUTORIAL-2013/Pneumatic Components folder. This is an assembly that you copied from the DVD in the book. The AirCylinder assembly is displayed in the Graphics window.



Mate to the first component added to the assembly. If you mate to the first component or base component of the assembly and decide to change its orientation later, all the components will move with it.



Determine the static and dynamic behavior of mates in each sub-assembly before creating the top level assembly.

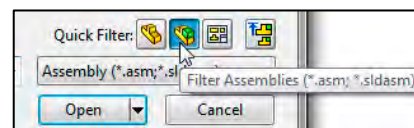
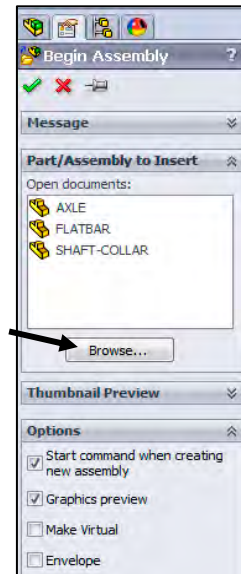
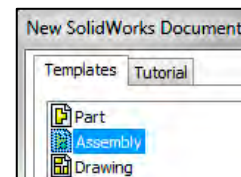
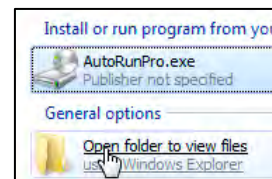

 Resolve an Assembly. Right-click the **assembly name** or **component name** from the FeatureManager. Click **Set Lightweight to Resolved**.

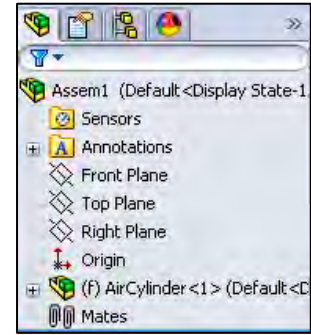

**203)** Click **OK**  from the Begin Assembly PropertyManager to fix the AirCylinder assembly in the Graphics window. The (f) symbol is placed in front of the AirCylinder name in the FeatureManager.

**204)** If required, click **Yes** to Rebuild.

**205)** Click **Save As** from the Menu bar.

**206)** Select **SW-TUTORIAL-2013** for Save in folder.

**207)** Enter **LINKAGE** for file name.

**208)** Click the **References** button. An assembly and drawing document has part/component references. You must save the assembly document and all of the reference components to the same folder.





**209)** Click the **Browse** button from the Specify folder for selected items.

**210)** Select the **SW-TUTORIAL-2013** folder.

**211)** Click **OK** from the Browse For Folder dialog box.

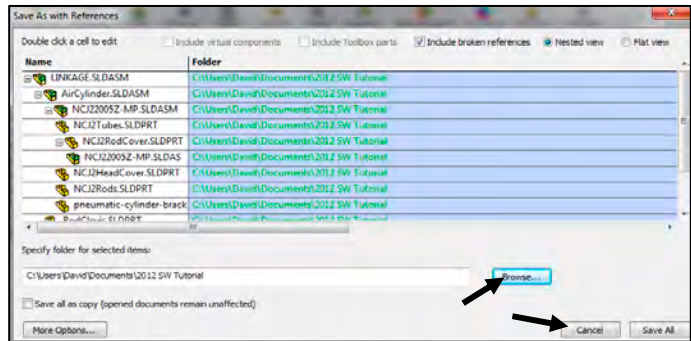
**212)** Click **Save All**. The LINKAGE assembly FeatureManager is displayed.



 You can also use the Pack and Go option to save an assembly or drawing with references. The Pack and Go tool saves either to a folder or creates a zip file to e-mail. View SolidWorks help for additional information.

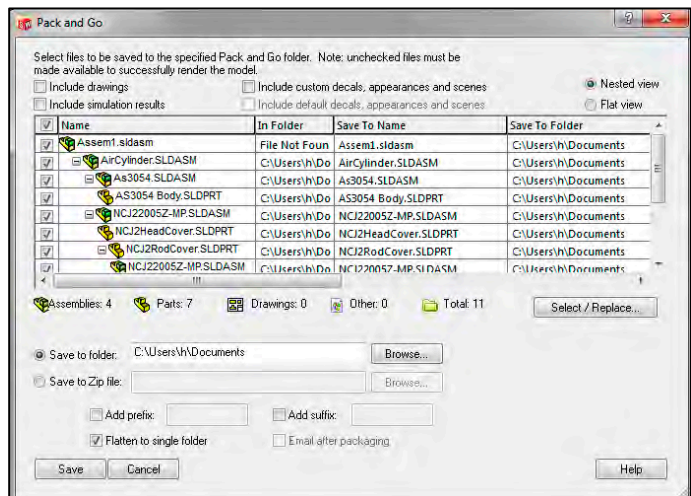

The AirCylinder assembly and its references are copied to the SW-TUTORIAL-2013 folder. Assemble the AXLE to the holes in the RodClevis.

Display the RodClevis component in the FeatureManager.

**213)** Expand the AirCylinder assembly in the FeatureManager.

**214)** Click **RodClevis<1>** from the FeatureManager.  
Note: The RodClevis is displayed in blue in the Graphics window.

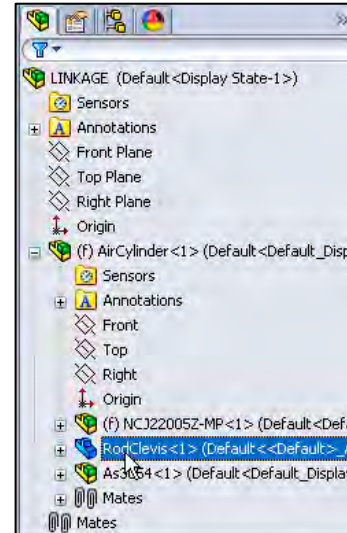
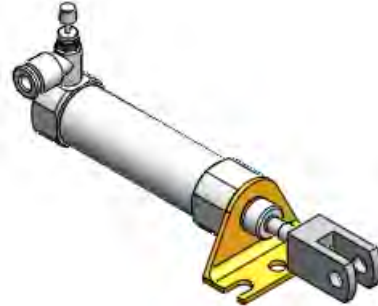

If required hide the Origins.

**215)** Click **View**; uncheck **Origins** from the Menu bar.

The AirCylinder is the first component in the LINKAGE assembly and is fixed (f) to the LINKAGE assembly Origin.

Display an Isometric view.

**216)** Click **Isometric view**  from the Heads-up View toolbar.

Insert the AXLE part.

**217)** Click the **Assembly** tab in the CommandManager.

**218)** Click the **Insert Components**  Assembly tool. The Insert Component PropertyManager is displayed.

**219)** Click the **Browse** button. Browse to the **SW-TUTORIAL-2013** folder. Note: If AXLE is active, double-click AXLE from the Open documents box. Skip the next few steps.

**220)** Click the **Filter Parts (\*.prt;\*.sldprt)** button in the Open dialog box to view part documents.



**221)** Double-click **AXLE** from the SW-TUTORIAL-2013 folder. Click a **position** to the front of the AirCylinder assembly as illustrated.

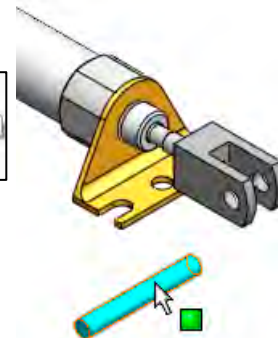
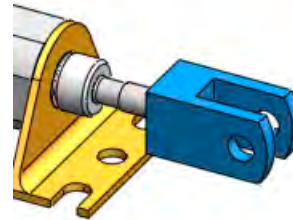

Move the AXLE component.

**222)** Click a **position** in front of the RODCLEVIS.

Enlarge the view.

**223)** **Zoom in** on the RodClevis and the AXLE.

Insert a Concentric mate.

**224)** Click the **Mate**  tool from the Assembly toolbar. The Mate PropertyManager is displayed.

**225)** Click the inside **front hole face** of the RodClevis. The cursor displays the face feedback symbol.

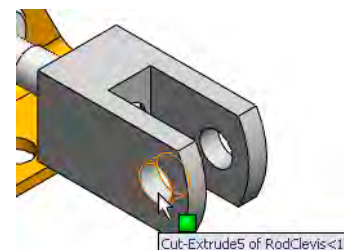

**226)** Click the **long cylindrical face** of the AXLE. The cursor displays the face feedback symbol. The selected faces are displayed in the Mate Selections box. Concentric mate is selected by default. The AXLE is positioned concentric to the RodClevish hole.

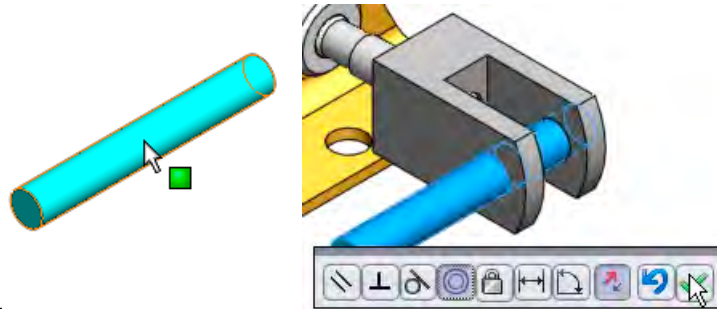

**227)** Click the **Green Check mark** ✓ as illustrated.

Move the AXLE.

**228)** Click and drag the **AXLE** left to right. The AXLE translates in and out of the RodClevish holes.

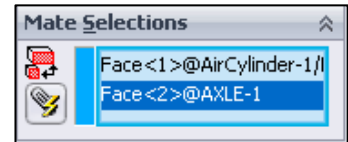

The Mate Pop-up toolbar is displayed after selecting the two cylindrical faces. The Mate Pop-up toolbar minimizes the time required to create a mate.

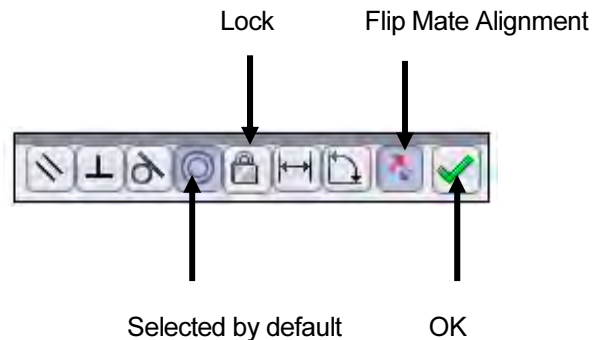

 Position the mouse pointer in the middle of the face to select the entire face. Do not position the mouse pointer near the edge of the face. If the wrong face or edge is selected, perform one of the following actions:

- Click the face or edge again to remove it from the Mate Selections box.
- Right-click in the Graphics window. Click Clear Selections to remove all geometry from the Items Selected text box.
- Right-click in the Mate Selections box to either select Clear Selections or to delete a single selection.
- Utilize the Undo button to begin the Mate command again.

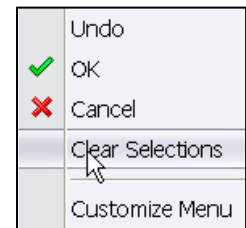

Display the Top view.

**229)** Click **Top view**  from the Heads-up View toolbar.

Expand the LINKAGE assembly and components in the fly-out FeatureManager.

**230)** **Expand** the LINKAGE assembly from the fly-out FeatureManager.

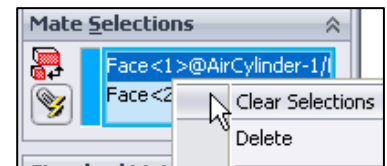

**231) Expand** the AirCylinder assembly from the fly-out FeatureManager.

**232) Expand** the AXLE part from the fly-out FeatureManager.

Clear all sections from the Mate Selections box.

**233) If needed, right-click **Clear Selections**** inside the Mate Selections box.

Insert a Coincident mate.

**234) Click the **Front Plane**** of the AirCylinder assembly from the fly-out FeatureManager.

**235) Click the **Front Plane**** of the AXLE part from the fly-out FeatureManager. The selected planes are displayed in the Mate Selections box. Coincident mate is selected by default.

**236) Click the **Green Check mark**** ✓.

**237) Click **OK**** ✓ from the Mate PropertyManager.

The AirCylinder Front Plane and the AXLE Front Plane are Coincident. The AXLE is centered in the RodClevis.



Display the Mates in the FeatureManager to check that the components and the mate types correspond to the design intent. Note: If you delete a mate and then recreate it, the mate numbers will be in a different order.

Display an Isometric view.

**238) Click **Isometric view**** .

Display the Mates in the folder.

**239) Expand** the Mates folder in the FeatureManager. View the created mates.

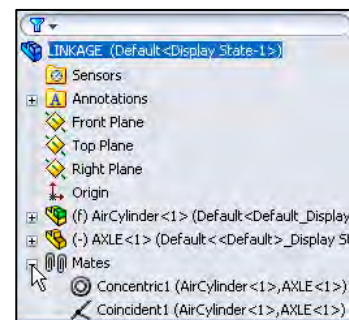
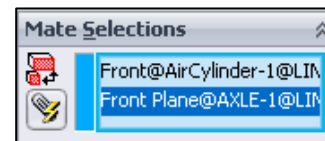
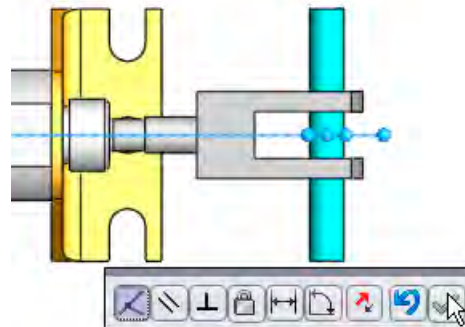
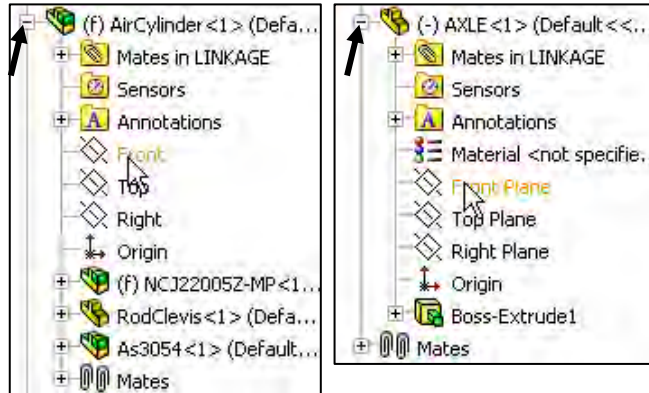

### Activity: LINKAGE Assembly-Insert FLATBAR Part

Insert the FLATBAR part.

**240) Click the **Insert Components****  Assembly tool. The Insert Component PropertyManager is displayed.

**241) Click the **Browse**** button.

**242) Browse to the **SW-TUTORIAL-2013**** folder.

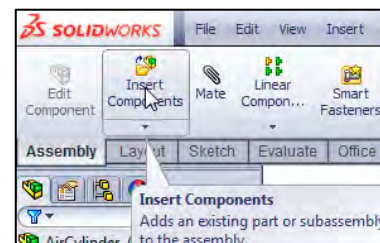

**243)** Click the **Filter Parts (\*.prt;\*.sldprt)** button in the Open dialog box to view part documents.

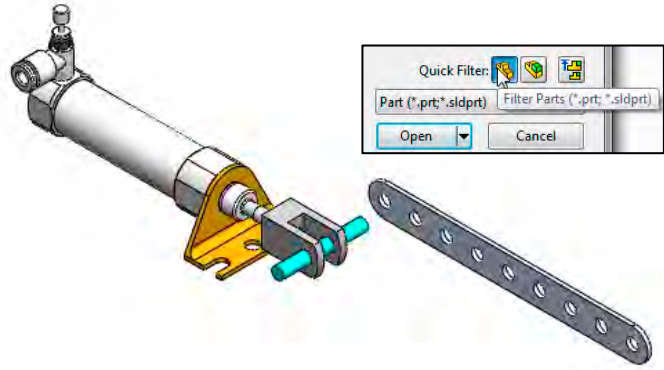

**244)** Double-click **FLATBAR**.

Place the component in the assembly.

**245)** Click a **position** in the Graphics window as illustrated. Note: Use the z key to Zoom out if required.

Enlarge the view.

**246)** **Zoom in** on the **AXLE** and the left side of the **FLATBAR** to enlarge the view.

Insert a Concentric mate.

**247)** Click the **Mate**  tool from the Assembly toolbar. The Mate PropertyManager is displayed. If required, right-click **Clear Selections** inside the Mate Selections box.

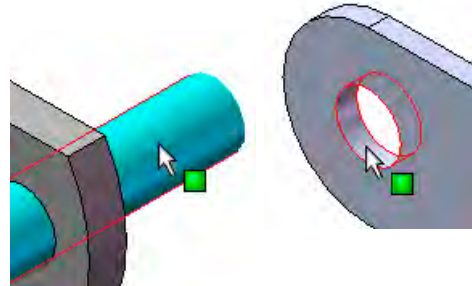

**248)** Click the inside **left hole face** of the **FLATBAR**.

**249)** Click the **long cylindrical face** of the **AXLE**. The selected faces are displayed in the Mate Selections box. Concentric is selected by default.

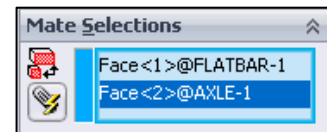

**250)** Click the **Green Check mark** .

Fit the model to the Graphics window.

**251)** Press the **f** key.

Move the **FLATBAR**.

**252)** Click and drag the **FLATBAR**. The **FLATBAR** translates and rotates along the **AXLE**.

Insert a Coincident mate.

**253)** Click the **front face** of the **FLATBAR**.

**254)** **Rotate** the model view the back face of the **RodClevis**.

**255)** Click the **back face** of the **RodClevis** as illustrated. The selected faces are displayed in the Mate Selections box. Coincident is selected by default.

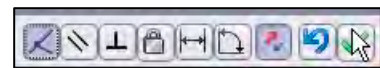
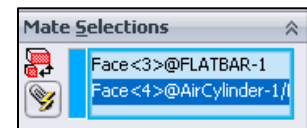
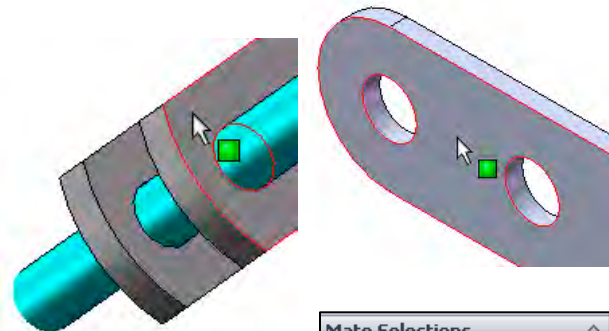

256) Click the **Green Check mark** ✓.

257) Click **OK** ✓ from the Mate PropertyManager.

Display the Isometric view.

258) Click **Isometric view**  from the Heads-up View toolbar.

Insert the second FLATBAR component.

259) Click the **Insert Components**  Assembly tool. The Insert Component PropertyManager is displayed.

260) Click the **Browse** button.

261) Browse to the **SW-TUTORIAL-2013** folder.

262) Click the **Filter Parts (\*.prt;\*.sldprt)** button in the Open dialog box to view part documents.

263) Double-click **FLATBAR**.

264) Click a **position** to the front of the AirCylinder in the Graphics window as illustrated.

Enlarge the view.

265) **Zoom in** on the second FLATBAR and the AXLE.

Insert a Concentric mate.

266) Click the **Mate**  tool from the Assembly tool. The Mate PropertyManager is displayed.

267) Click the **left inside hole face** of the second FLATBAR.

268) Click the **long cylindrical face** of the AXLE. The selected faces are displayed in the Mate Selections box. Concentric is selected by default.

269) Click the **Green Check mark** ✓.

270) Click and drag the **second FLATBAR** to the front.

Fit the model to the Graphics window.

271) Press the **f** key.

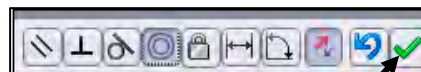
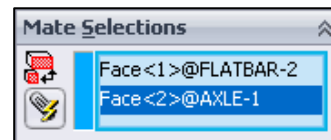
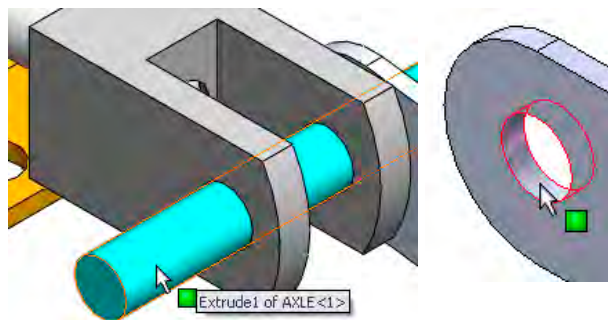
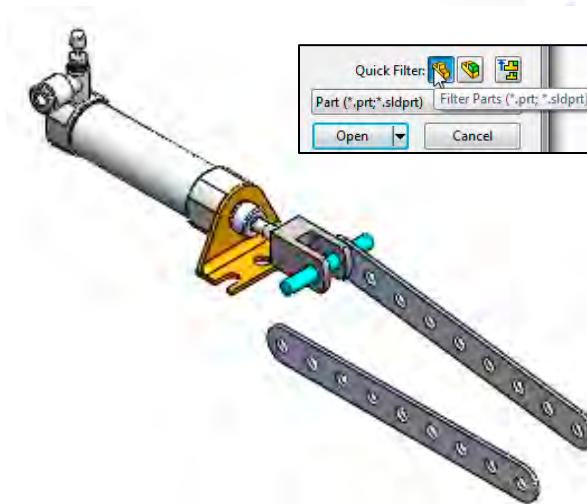
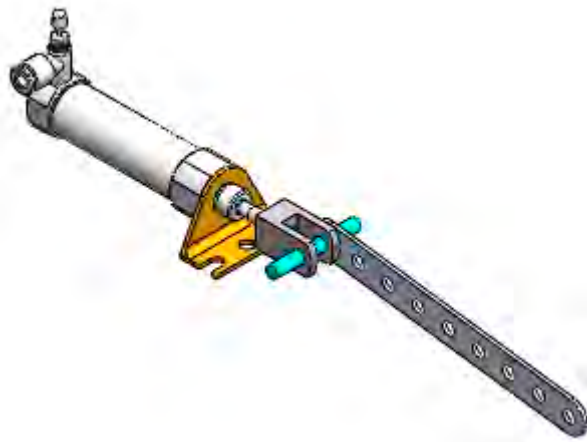



Insert a Coincident mate.

- 272)** Press the **left arrow key** approximately 5 times to rotate the model to view the back face of the second FLATBAR.
- 273)** Click the **back face** of the second FLATBAR.
- 274)** Press the **right arrow key** approximately 5 times to rotate the model to view the front face of the RodClevis.
- 275)** Click the **front face** of the RodClevis. The selected faces are displayed in the Mate Selections box. Coincident is selected by default.
- 276)** Click the **Green Check mark** ✓.

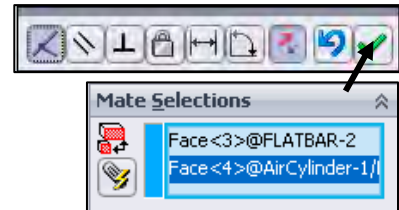
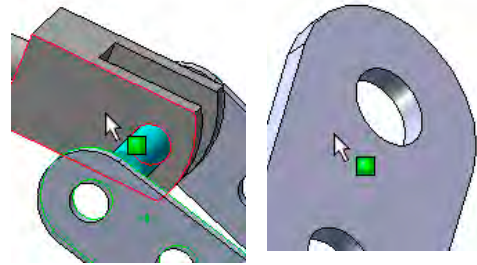

Insert a Parallel mate.

- 277)** Press the **Shift-z** keys to Zoom in on the model.
- 278)** Click the **top narrow face** of the first FLATBAR.
- 279)** Click the **top narrow face** of the second FLATBAR. The selected faces are displayed in the Mate Selections box.
- 280)** Click **Parallel** ∥.
- 281)** Click the **Green Check mark** ✓.
- 282)** Click **OK** ✓ from the Mate PropertyManager.
- 283)** Click **Isometric view** 📐 from the Heads-up View toolbar.

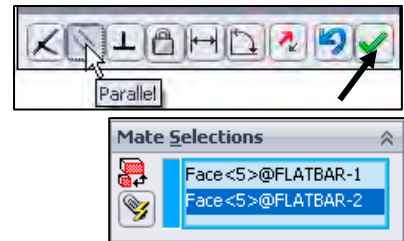
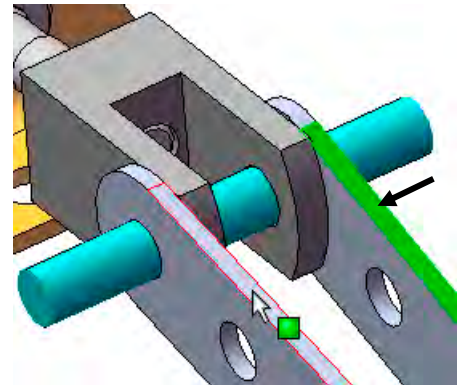

Move the two FLATBAR parts.

- 284)** Click and drag the **second FLATBAR**. Both FLATBAR parts move together.

View the Mates folder.

- 285)** **Expand** the Mates folder from the FeatureManager. View the created mates.

💡 Determine the static and dynamic behavior of mates in each sub-assembly before creating the top level assembly.

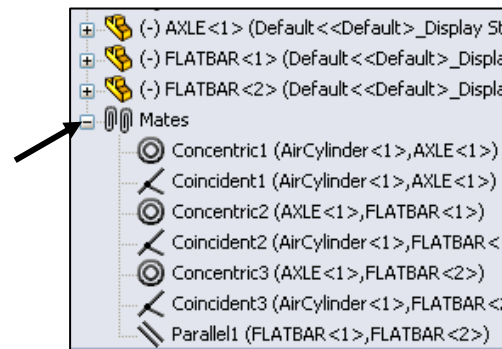

**Activity: LINKAGE Assembly-Insert SHAFT-COLLAR Part**

Insert the first SHAFT-COLLAR.

**286)** Click the **Insert Components**  Assembly tool. The Insert Component PropertyManager is displayed.

**287)** Click the **Browse** button.

**288)** Browse to the **SW-TUTORIAL-2013** folder.

**289)** Click the **Filter Parts (\*.prt;\*.sldprt)** button in the Open dialog box to view part documents.



**290)** Double-click **SHAFT-COLLAR**.

**291)** Click a **position** to the back of the **AXLE** as illustrated.

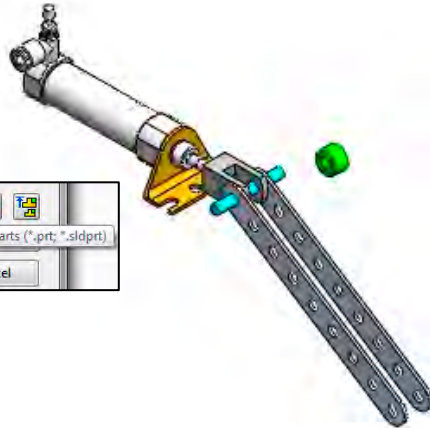

Enlarge the view.

**292)** Click the **Zoom to Area**  tool.

**293)** **Zoom-in** on the SHAFT-COLLAR and the AXLE component.

Deactivate the tool.

**294)** Click the **Zoom to Area**  tool.

Insert a Concentric mate.

**295)** Click the **Mate**  tool from the Assembly toolbar. The Mate PropertyManager is displayed.

**296)** Click the **inside hole face** of the SHAFT-COLLAR.

**297)** Click the **long cylindrical face** of the AXLE. The selected faces are displayed in the Mate Selections box. Concentric is selected by default.

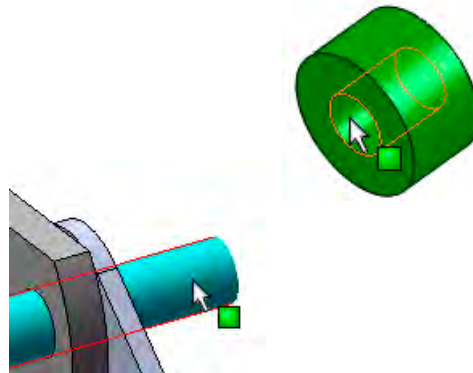

**298)** Click the **Green Check mark** .

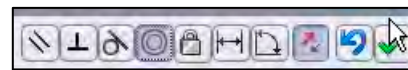

Insert a Coincident mate.

**299)** Press the **Shift-z** keys to Zoom in on the model.

**300)** Click the **front face** of the SHAFT-COLLAR as illustrated.

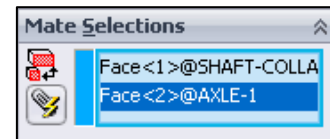

**301)** **Rotate** the model to view the back face of the first FLATBAR.

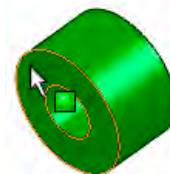

**302)** Click the **back face** of the first FLATBAR. The selected faces are displayed in the Mate Selections box. Coincident is selected by default.

**303)** Click the **Green Check mark** ✓.

**304)** Click **OK** ✓ from the Mate PropertyManager.

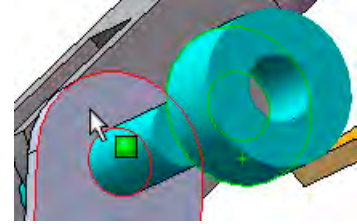

Display the Isometric view.

**305)** Click **Isometric view**  from the Heads-up View toolbar.

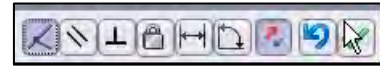

Insert the second SHAFT-COLLAR.

**306)** Click the **Insert Components**  Assembly tool. The Insert Component PropertyManager is displayed.

**307)** Click the **Browse** button.

**308)** Browse to the **SW-TUTORIAL-2013** folder.

**309)** Click the **Filter Parts** **(\*prt;\*.sldprt)** button in the Open dialog box to view part documents.



**310)** Double-click **SHAFT-COLLAR**.

**311)** Click a **position** near the AXLE as illustrated.

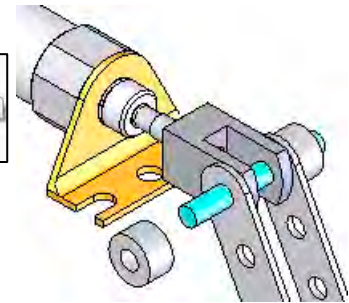

Enlarge the view.

**312)** Click the **Zoom to Area**  tool.

**313)** **Zoom-in** on the second SHAFT-COLLAR and the AXLE to enlarge the view.

**314)** Click the **Zoom to Area**  tool to deactivate the tool.

Insert a Concentric mate.

**315)** Click **Mate**  from the Assembly toolbar. The Mate PropertyManager is displayed.

**316)** Click the **inside hole face** of the second SHAFT-COLLAR.

**317)** Click the **long cylindrical face** of the AXLE. Concentric is selected by default. The selected faces are displayed in the Mate Selections box.

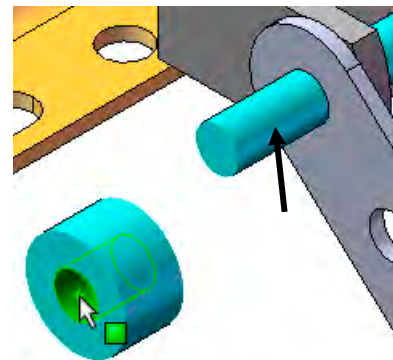

**318)** Click the **Green Check mark** ✓.

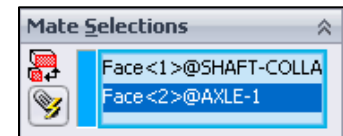

Insert a Coincident mate.

**319)** Click the **back face** of the second SHAFT-COLLAR.

**320)** Click the **front face** of the second FLATBAR. The selected faces are displayed in the Mate Selections box. Coincident is selected by default.

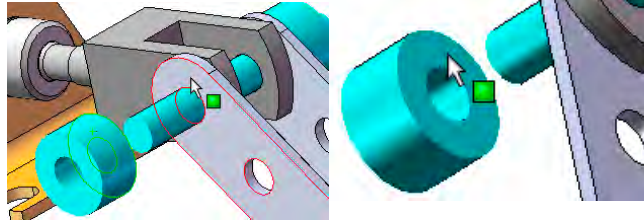

**321)** Click the **Green Check mark** ✓.

**322)** Click **OK** ✓ from the Mate PropertyManager.

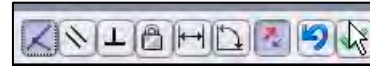

**323)** **Expand** the Mates folder. View the created mates.

Display an Isometric view.

**324)** Click **Isometric view**  from the Heads-up View toolbar.

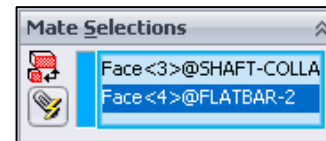

Fit the model to the Graphics window.

**325)** Press the **f** key.

Save the LINKAGE assembly.

**326)** Click **Save** . Click **Rebuild and Save** the document. The LINKAGE assembly is complete.

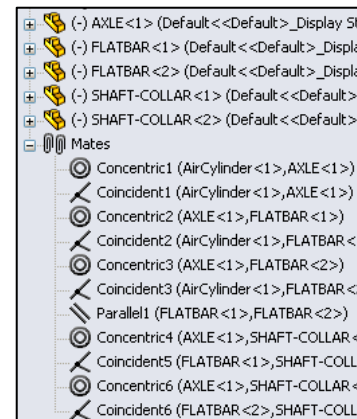

Use the Pack and Go option to save an assembly or drawing with references. The Pack and Go tool saves either to a folder or creates a zip file to e-mail. View SolidWorks help for additional information.



## Review the LINKAGE Assembly

An assembly is a document that contains two or more parts. A part or sub-assembly inserted into an assembly is called a component. You created the LINKAGE assembly. The AirCylinder sub-assembly was the first component inserted into the LINKAGE assembly. The AirCylinder assembly was obtained from the DVD in the book and copied to the SW-TUTORIAL-2013 folder.

The AirCylinder assembly was fixed to the Origin. The Concentric and Coincident mates added Geometric relationships between the inserted components in the LINKAGE assembly.

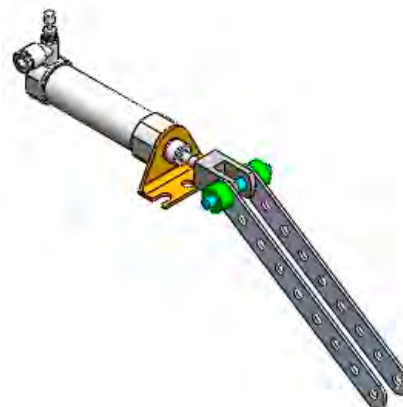



To remove the fixed state, Right-click a component name in the FeatureManager. Click Float. The component is free to move.

The AXLE part was the second component inserted into the LINKAGE assembly. The AXLE required a Concentric mate between the two cylindrical faces and a Coincident mate between two the Front Planes.

The FLATBAR part was the third component inserted into the LINKAGE assembly. The FLATBAR required a Concentric mate between the two cylindrical faces and a Coincident mate between the two flat faces.

A second FLATBAR was inserted into the LINKAGE assembly. A Parallel mate was added between the two FLATBARs.

Two SHAFT-COLLAR parts were inserted into the LINKAGE assembly. Each SHAFT-COLLAR required a Concentric mate between the two cylindrical faces and a Coincident mate between the two flat faces.

## Motion Study - Basic Motion Tool

Motion Studies are graphical simulations of motion for assembly models. You can incorporate visual properties such as lighting and camera perspective into a motion study. Motion studies do not change an assembly model or its properties. They simulate and animate the motion you prescribe for your model. Use SolidWorks mates to restrict the motion of components in an assembly when you model motion.

Create a Motion Study. Select the Basic Motion option from the MotionManager. The Basic Motion option provides the ability to approximate the effects of motors, springs, collisions and gravity on your assembly. Basic Motion takes mass into account in calculating motion. Note: The Animation option does not!

### Activity: LINKAGE Assembly-Basic Motion

Insert a Rotary Motor using the Motion Study tab.

**327)** Click the **Motion Study 1** tab located in the bottom left corner of the Graphics window. The MotionManager is displayed.

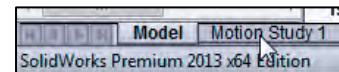

**328)** Select **Basic Motion** for Type of study from the MotionManager drop-down menu as illustrated.

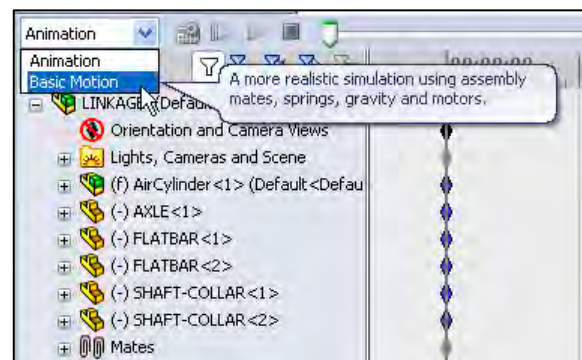

329) Click **Motor**  from the MotionManager. The Motor PropertyManager is displayed.

330) Click the **Rotary Motor** box.

331) Click the **FLATBAR front face** as illustrated. A red Rotary Motor icon is displayed. The red direction arrow points counterclockwise.

332) Enter **150 RPM** for speed in the Motion box.

333) Click **OK**  from the Motor PropertyManager.

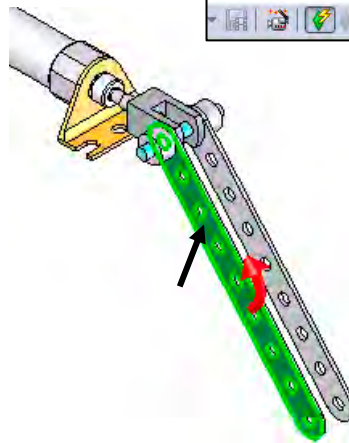
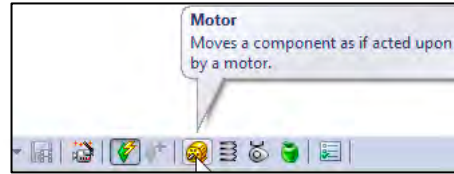

Record the Simulation.

334) Click **Calculate** . The FLATBAR rotates in a counterclockwise direction for a set period of time.

335) Click **Play** . View the simulation.

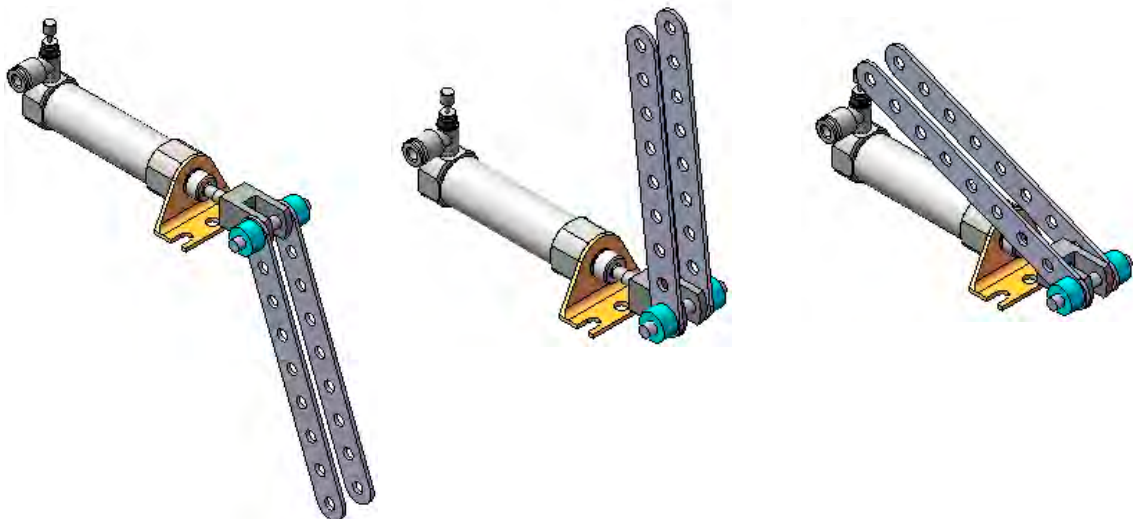

LINKAGE Assembly Basic Simulation

Save the simulation in an AVI file to the SW-TUTORIAL-2013 folder.

**336)** Click **Save Animation**.

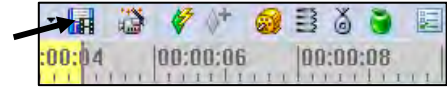

**337)** Click **Save** from the Save Animation to File dialog box. View your options.

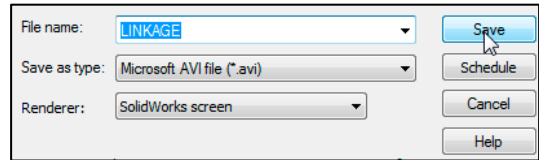

**338)** Click **OK** from the Video Compression box.

Close the Motion Study and return to SolidWorks.

**339)** Click the **Model** tab location in the bottom left corner of the Graphics window.

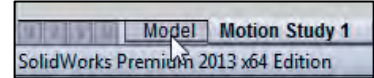

Fit the assembly to the Graphics window.

**340)** Press the **f** key.

Save the LINKAGE assembly.

**341)** Click **Save** .

Exit SolidWorks.

**342)** Click **Windows, Close All** from the Menu bar.

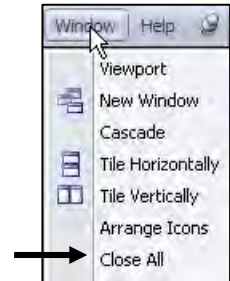

The LINKAGE assembly chapter is complete.

 Rename a feature or sketch for clarity. Slowly click the feature or sketch name twice and enter the new name when the old one is highlighted.

 Use the Pack and Go option to save an assembly or drawing with references. The Pack and Go tool saves either to a folder or creates a zip file to e-mail. View SolidWorks help for additional information.

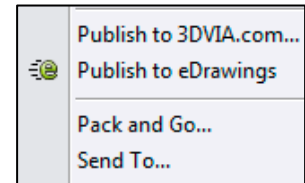

### Review the Motion Study

The Rotary Motor Basic Motion tool combined Mates and Physical Dynamics to rotate the FLATBAR components in the LINKAGE assembly. The Rotary Motor was applied to the front face of the FLATBAR. You utilized the Calculate option to play the simulation. You saved the simulation in an .AVI file.

 Additional details on Motion Study, Assembly, mates, and Simulation are available in SolidWorks help. Keywords: Motion Study and Basic Motion.

## Chapter Summary

In this chapter, you created three parts (AXLE, SHAFT-COLLAR and FLATBAR), copied the AirCylinder assembly from the DVD in the book and created the LINKAGE assembly.

You developed an understanding of the SolidWorks User Interface: Menus, Toolbars, Task Pane, CommandManager, FeatureManager, System feedback icons, Document Properties, Parts and Assemblies.

You created 2D sketches and addressed the three key states of a sketch: *Fully Defined*, *Over Defined* and *Under Defined*. Note: Always review your FeatureManager for the proper sketch state.

You obtained the knowledge of the following SolidWorks features: Extruded Boss/Base, Extruded Cut, and Linear Pattern. Features are the building blocks of parts. The Extruded Boss/Base feature required a Sketch plane, sketch, and depth.

The Extruded Boss/Base feature added material to a part. The Boss-Extruded1 feature was utilized in the AXLE, SHAFT-COLLAR and FLATBAR parts.

The Extruded Cut feature removed material from the part. The Extruded Cut feature was utilized to create a hole in the SHAFT-COLLAR and FLATBAR parts. Note: Both were Through All holes. We will address the Hole Wizard later in the book.

The Linear Pattern feature was utilized to create an array of holes in the FLATBAR part.

When parts are inserted into an assembly, they are called components. You created the LINKAGE assembly by inserting the AirCylinder assembly, AXLE, SHAFT-COLLAR and FLATBAR parts.

Mates are geometric relationships that align and fit components in an assembly. Concentric, Coincident and Parallel mates were utilized to assemble the components.

You created a Motion Study. The Rotary Motor Basic Motion tool combined Mates and Physical Dynamics to rotate the FLATBAR components in the LINKAGE assembly.



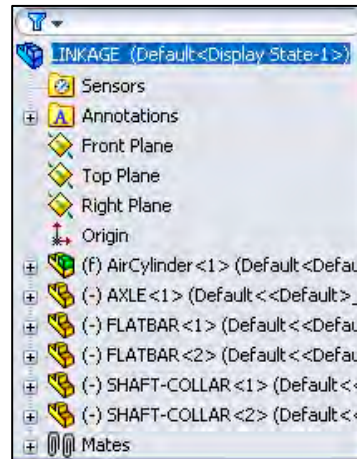

During the initial SolidWorks installation, you are requested to select either the ISO or ANSI drafting standard. ISO is typically an European drafting standard and uses First Angle Projection. The book is written using the ANSI (US) overall drafting standard and Third Angle Projection for drawings.



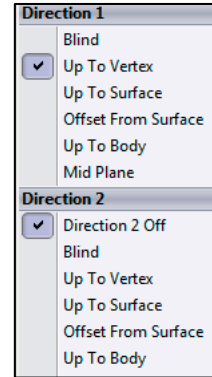

 You can right-click anywhere on an extruded feature and change the end condition from a shortcut menu. You can click in empty space, on geometry, or on the handle. The shortcut menu provides options for Direction 1 and Direction 2. Note: Options are document dependent.



 For many features; (Extruded Boss/ Base, Extruded Cut, Simple Hole, Revolved Boss/Base, Revolved Cut, Fillet, Chamfer, Scale, Shell, Rib, Circular Pattern, Linear Pattern, Curve Driven Pattern, Revolved Surface, Extruded Surface, Fillet Surface, Edge Flange and Base Flange) you can enter and modify equations directly in the PropertyManager fields that allow numerical inputs.

Create equations with global variables, functions, and file properties without accessing the Equations, Global Variables and Dimensions dialog box.

For example, in the Extruded Cut PropertyManager you can enter equations in:

- Depth fields for Direction 1 and Direction 2
- Draft fields for Direction 1 and Direction 2
- Thickness fields for a Thin Feature with two direction types
- Offset Distance field

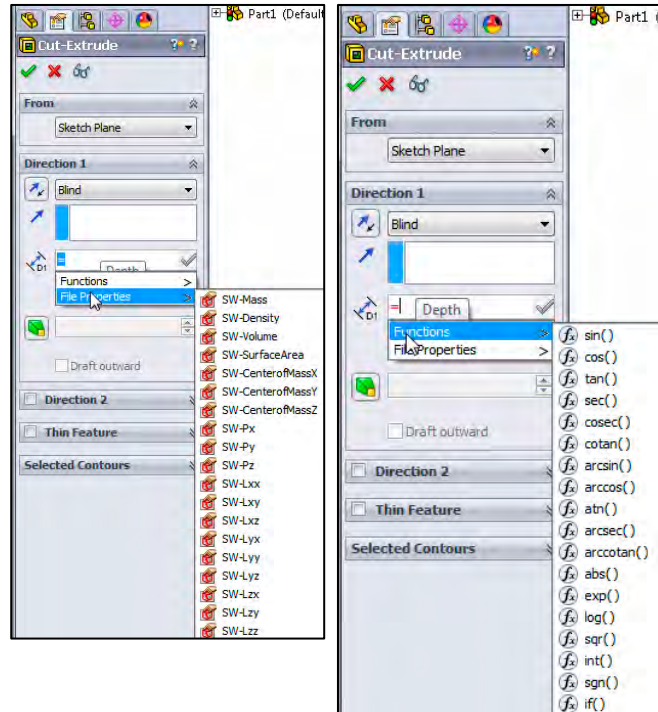

To create an equation in a numeric input field, start by entering = (equal sign). A drop-down list displays options for global variables, functions, and file properties. Numeric input fields that contain equations can display either the equation itself or its evaluated value.

 Click the What's new  icon in the PropertyManager to learn what's new about a feature or option.



Design Intent is how your part reacts as parameters are modified. Example: If you have a hole in a part that must always be  $.125 \leq$  from an edge, you would dimension to the edge rather than to another point on the sketch. As the part size is modified, the hole location remains  $.125 \leq$  from the edge.



The Instance to Vary option in the Linear Pattern PropertyManager allows you to vary the dimensions and locations of instances in a feature pattern *after it is created*. You can vary the dimensions of a series of instances, so that each instance is larger or smaller than the previous one. You can also change the dimensions of a single instance in a pattern and change the position of that instance relative to the seed feature of the pattern. For linear patterns, you can change the spacing between the columns and rows in the pattern.

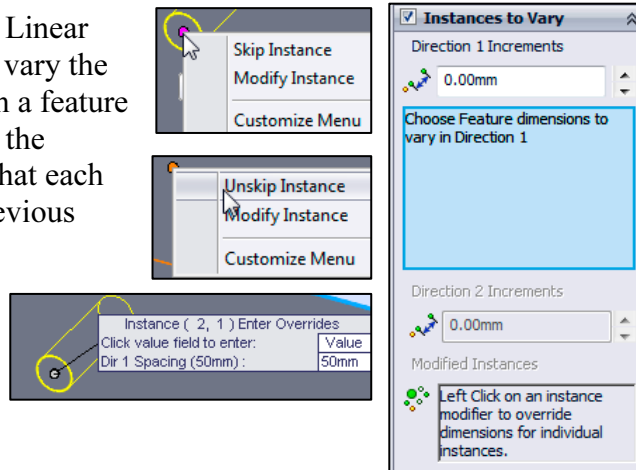

To display the Selection Filter toolbar, click **View, Toolbars, Selection Filter**. The Selection Filter is displayed.



To clear a Filter icon , click **Clear All Filters** from the Selection Filter toolbar.

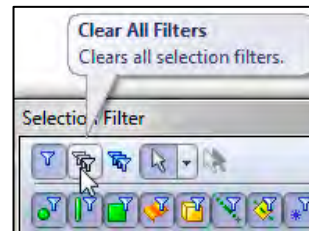

## Chapter Terminology

Utilize SolidWorks Help for additional information on the terms utilized in this chapter.

**Assembly:** An assembly is a document which contains parts, features, and other sub-assemblies. When a part is inserted into an assembly it is called a component. Components are mated together. The filename extension for a SolidWorks assembly file name is .SLDASM.

**Component:** A part or sub-assembly within an assembly.

**Cursor Feedback:** Feedback is provided by a symbol attached to the cursor arrow indicating your selection. As the cursor floats across the model, feedback is provided in the form of symbols, riding next to the cursor.

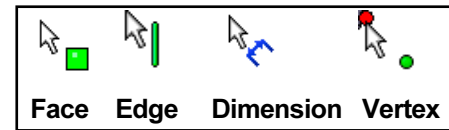

**Dimension:** A value indicating the size of feature geometry.

**Drafting Standard:** A set of drawing and detailing options developed by national and international organizations. The Dimensioning standard options are: ANSI, ISO, DIN, JIS, BSI, GOST and GB.

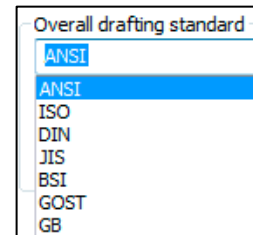

**Features:** Features are geometry building blocks. Features add or remove material. Features are created from sketched profiles or from edges and faces of existing geometry.

**Instance Number:** The instance number increments every time you insert the same component or mate. If you delete a component or mate and then reinsert the component or mate in the same SolidWorks session, the instance number increments by one.

**Mates:** A mate is a geometric relationship between components in an assembly.

**Mouse Buttons:** The left and right mouse buttons have distinct meanings in SolidWorks. Left mouse button is utilized to select geometry. Right-mouse button is utilized to invoke commands.

**Part:** A part is a single 3D object made up of features. The filename extension for a SolidWorks part file name is .SLDPRT.

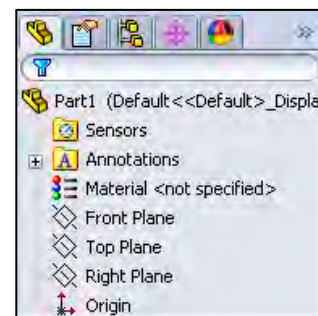

**Plane:** To create a sketch, select a plane. Planes are flat and infinite. They are represented on the screen with visible edges. The reference plane for this project is the Front Plane.

**Relation:** A relation is a geometric constraint between sketch entities or between a sketch entity and a plane, axis, edge, or vertex.

**Sketch:** The name to describe a 2D profile is called a sketch. 2D Sketches are created on flat faces and planes within the model. Typical geometry types are lines, arcs, rectangles, circles, polygons and ellipses.

**Status of a Sketch:** Three states are utilized in this chapter: *Fully Defined:* Has complete information (dimensions and geometric relations) displayed in black, *Over Defined:* Has duplicate (dimensions or geometric relations) displayed in Red/Yellow or *Under Defined:* There is inadequate definition (dimensions or geometric relations) displayed in Blue and black.

**Toolbars:** The toolbar menus provide shortcuts enabling you to quickly access the most frequently used commands.

**Trim Entities:** Deletes selected sketched geometry. Extends a sketch segment unit it is coincident with another entity.

**Units:** Used in the measurement of physical quantities. Millimeter dimensioning and decimal inch dimensioning are the two types of common units specified for engineering parts and drawings.

**Questions**

1. Explain the steps in starting a SolidWorks session.
2. Describe the procedure to begin a new 2D sketch.
3. Explain the steps required to modify units in a part document from inches to millimeters.
4. Describe the procedure to create a simple 3D part with an Extruded Boss/Base (Boss-Extrude1) feature.

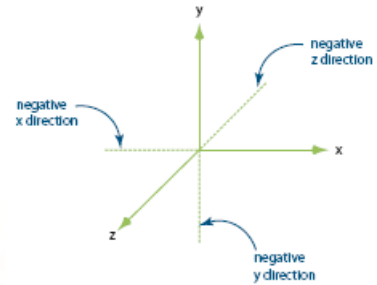
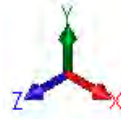

5. Identify the three default Reference planes in SolidWorks.
6. Describe a Base feature? Provide two examples from this chapter.
7. Describe the differences between an Extruded Boss/Base feature and an Extruded Cut feature.
8. The sketch color black indicates a sketch is \_\_\_\_\_ defined.

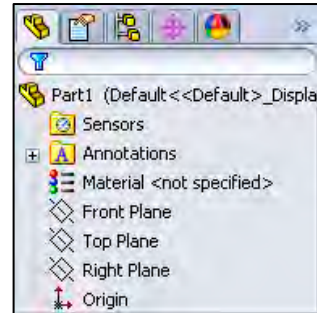

9. The sketch color blue indicates a sketch is \_\_\_\_\_ defined.
10. The sketch color red indicates a sketch is \_\_\_\_\_ defined.
11. Describe the procedure to “wake up” a center point in a sketch.
12. Define a Geometric relation. Provide three examples.

13. Describe the procedure to create a Linear Pattern feature.
14. Describe an assembly or sub-assembly.

15. What are mates and why are they important in assembling components?
16. In an assembly, each component has \_\_\_\_\_ # degrees of freedom? Name them.

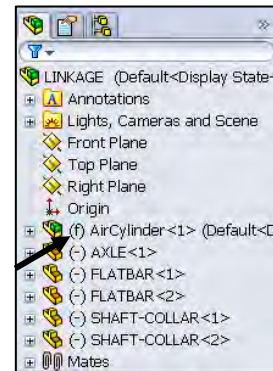

17. True or False. A fixed component cannot move in an assembly.
18. Review the Design Intent section in the book. Identify how you incorporated design intent into a part or assembly document.

## Exercises

**Exercise 1.1:** Identify the Sketch plane for the Boss-Extrude1 (Base) feature as illustrated. Simplify the number of features!

- A: Top Plane
- B: Front Plane
- C: Right Plane
- D: Left Plane

Correct answer \_\_\_\_\_.

Create the part. Dimensions are arbitrary.

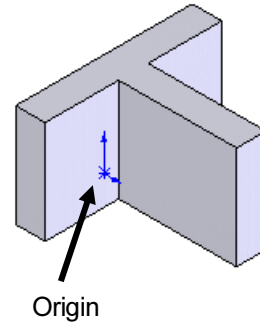

**Exercise 1.2:** Identify the Sketch plane for the Boss-Extrude1 (Base) feature as illustrated. Simplify the number of features!

- A: Top Plane
- B: Front Plane
- C: Right Plane
- D: Left Plane

Correct answer \_\_\_\_\_.

Create the part. Dimensions are arbitrary.

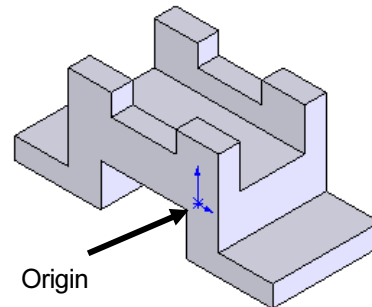

**Exercise 1.3:** Identify the Sketch plane for the Boss-Extrude1 (Base) feature as illustrated. Simplify the number of features!

- A: Top Plane
- B: Front Plane
- C: Right Plane
- D: Left Plane

Correct answer \_\_\_\_\_.

Create the part. Dimensions are arbitrary.

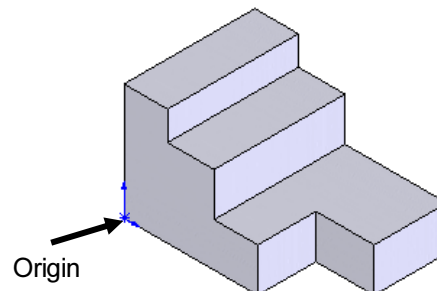

**Exercise 1.4: FLATBAR - 3HOLE Part**

Create an ANSI, IPS FLATBAR - 3HOLE part document.

- Utilize the Front Plane for the Sketch plane. Insert an Extruded Base (Boss-Extrude1) feature. No Tangent Edges displayed.
- Create an Extruded Cut feature. This is your seed feature. Apply the Linear Pattern feature. The FLATBAR - 3HOLE part is manufactured from 0.06in., [1.5mm] 6061 Alloy.

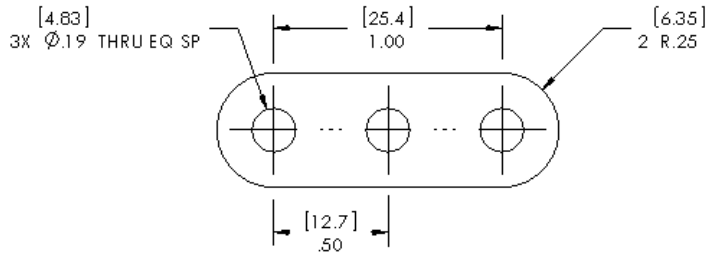
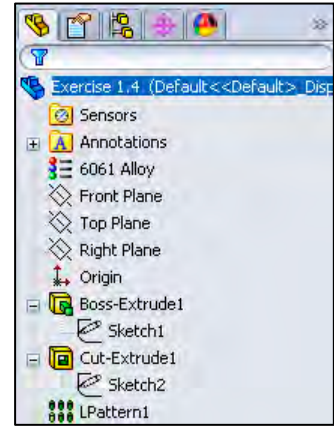

**Exercise 1.5: FLATBAR - 5HOLE Part**

Create an ANSI, IPS, FLATBAR - 5HOLE part as illustrated.

- Utilize the Front Plane for the Sketch plane. Insert an Extruded Base (Boss-Extrude1) feature.
- Create an Extruded Cut feature. This is your seed feature. Apply the Linear Pattern feature. The FLATBAR - 5HOLE part is manufactured from 0.06in, [1.5mm] 6061 Alloy.
- Calculate the required dimensions for the FLATBAR - 5HOLE part. Use the following information: Holes are .500in. on center, Radius is .250in., and Hole diameter is .190in.

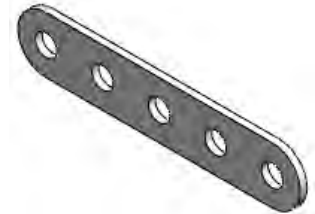

- No Tangent edges displayed.

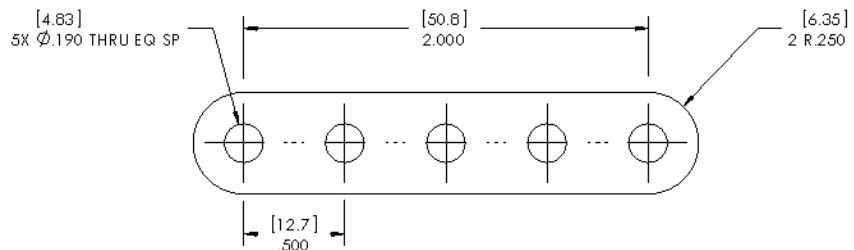

💡 Think design intent. When do you use the various End Conditions and Geometric sketch relations? What are you trying to do with the design? How does the component fit into an Assembly?

**Exercise 1.6: Simple Block Part**

Create the illustrated ANSI part. Note the location of the Origin in the illustration.

- Calculate the overall mass of the illustrated model.
- Apply the Mass Properties tool.
- Think about the steps that you would take to build the model.
- Review the provided information carefully.
- Units are represented in the IPS, (inch, pound, second) system.
- $A = 3.50\text{in}$ ,  $B = .70\text{in}$

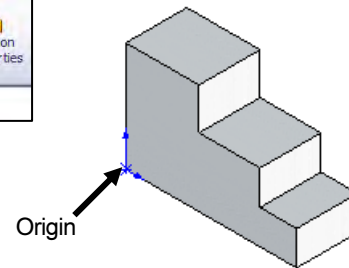
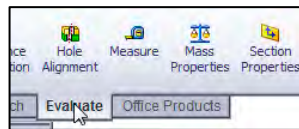
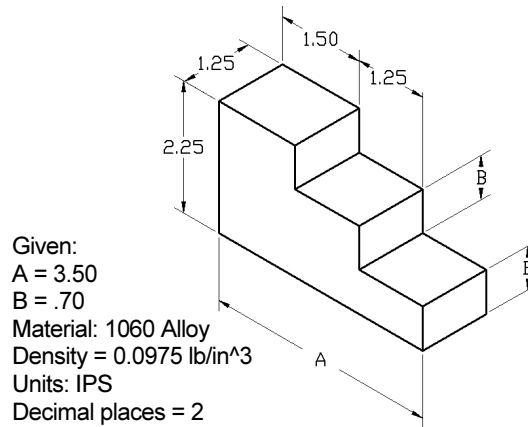
**Exercise 1.7: Simple Block Part**

Create the illustrated ANSI part. Note the location of the Origin in the illustration.

Create the sketch symmetric about the Front Plane. The Front Plane in this problem is **not** your Sketch Plane. Utilize the Blind End Condition in Direction 1.

- Calculate the overall mass of the illustrated model.
- Apply the Mass Properties tool.
- Think about the steps that you would take to build the model.
- Review the provided information carefully. Units are represented in the IPS, (inch, pound, second) system.
- $A = 3.00\text{in}$ ,  $B = .75\text{in}$

Note: Sketch1 is symmetrical.

Given:  
 $A = 3.00$   
 $B = .75$   
 Material: Copper  
 Density =  $0.321 \text{ lb/in}^3$   
 Units: IPS  
 Decimal places = 2

