

# An Introduction to SolidWorks® Flow Simulation 2013

John E. Matsson, Ph.D.



Visit the following websites to learn more about this book:



[amazon.com](https://www.amazon.com)

[Google books](https://books.google.com)

[BARNES & NOBLE](https://www.barnesandnoble.com)

## **Chapter 2 Flat Plate Boundary Layer**

### **Objectives**

- Creating the SolidWorks part needed for the Flow Simulation
- Setting up Flow Simulation projects for internal flow
- Setting up a two-dimensional flow condition
- Initializing the mesh
- Selecting boundary conditions
- Inserting global goals, point goals and equation goals for the calculations
- Running the calculations
- Using Cut Plots to visualize the resulting flow field
- Use of XY Plots for velocity profiles, boundary layer thickness, displacement thickness, momentum thickness and friction coefficients
- Use of Excel templates for XY Plots
- Comparison of Flow Simulation results with theories and empirical data
- Cloning of the project

### **Problem Description**

In this chapter, we will use SolidWorks Flow Simulation to study the two-dimensional laminar and turbulent flow on a flat plate and compare with the theoretical Blasius boundary layer solution and empirical results. The inlet velocity for the 1 m long plate is 5 m/s and we will be using air as the fluid for laminar calculations and water to get a higher Reynolds number for turbulent boundary layer calculations. We will determine the velocity profiles and plot the profiles using the well-known boundary layer similarity coordinate. The variation of boundary-layer thickness, displacement thickness, momentum thickness and the local friction coefficient will also be determined. We will start by creating the part needed for this simulation, see figure 2.0.

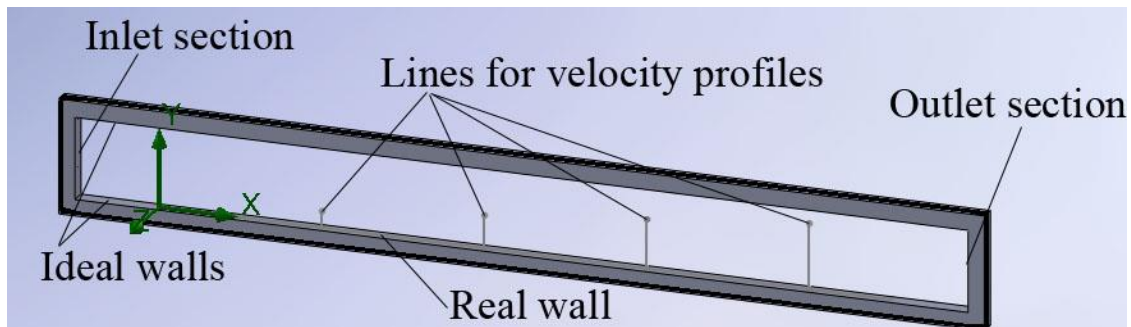

Figure 2.0 SolidWorks model for flat plate boundary layer study

### Creating the SolidWorks Part

1. Start by creating a new part in SolidWorks: select **File>>New** and click on the **OK** button in the **New SolidWorks Document** window. Click on **Front Plane** in the **FeatureManager design tree** and select **Front** from the **View Orientation** drop down menu in the graphics window.

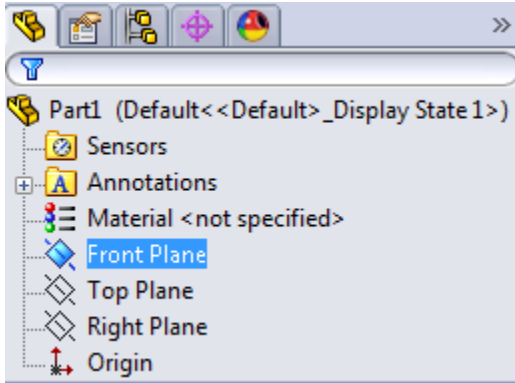

Figure 2.1a) Selection of front plane

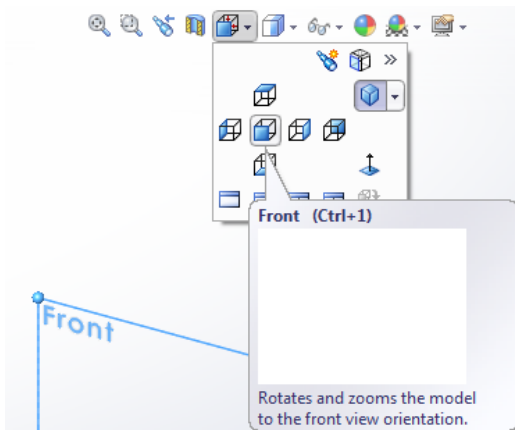

Figure 2.1b) Selection of front view

2. Click on **Corner Rectangle**.

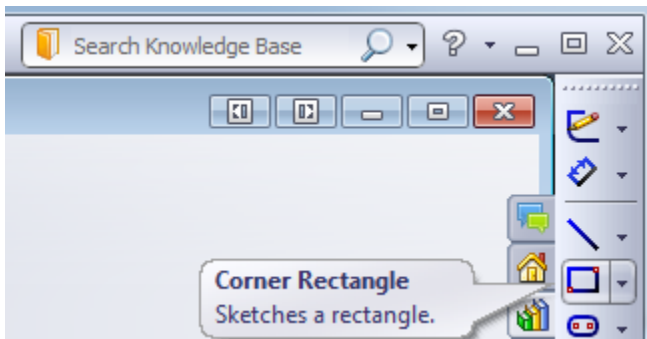



Figure 2.2a) Selecting a sketch tool

3. Make sure that you have **MMGS** (millimeter, gram, second) chosen as your unit system. You can check this by selecting **Tools>>Options** from the SolidWorks menu and selecting the **Document Properties** tab followed by clicking on **Units**. Click to the left and below the origin in the graphics window and drag the rectangle to the right and upward. Fill in the parameters for the rectangle: 1000 mm wide and 100 mm high. Close the Rectangle dialog box by clicking on . Right click in the graphics window and select **Zoom/Pan/Rotate>>**  **Zoom to Fit**.

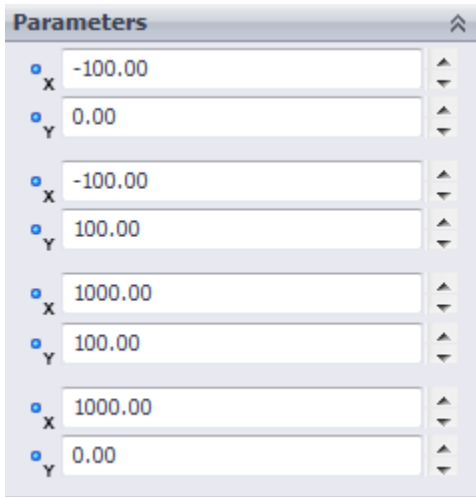

Figure 2.3a) Parameter settings for the rectangle

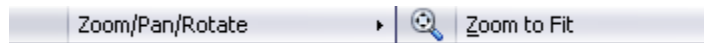

Figure 2.3b) Zooming in the graphics window

4. Repeat steps 2 and 3 but create a larger rectangle outside of the first rectangle. Dimensions are shown in Figure 2.4.

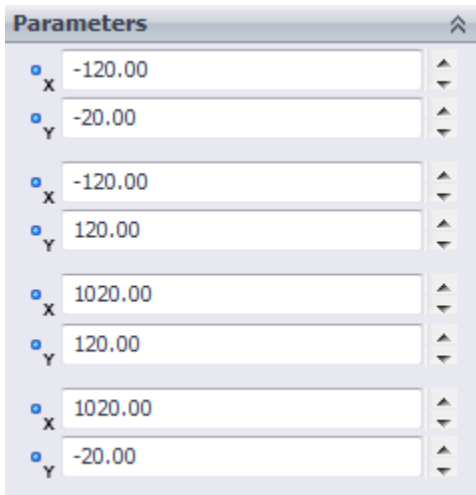

Figure 2.4 Dimensions of second larger rectangle

5. Select **Extruded Boss/Base**. Check the box for  **Direction 2** and click  **OK** to exit the **Boss-Extrude Property Manager**.

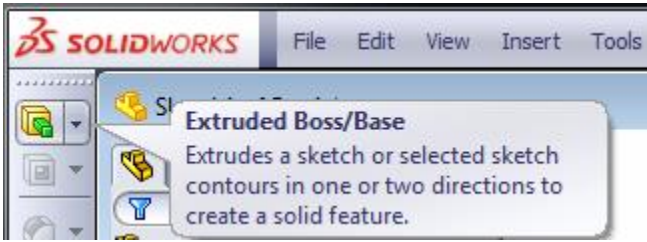

Figure 2.5a) Selection of extruded boss/base

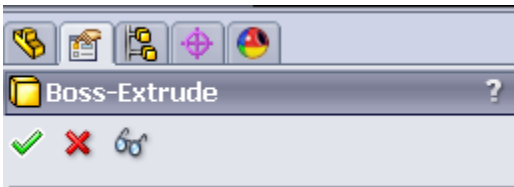

Figure 2.5b) Closing the property manager

6. Select **Front** from the **View Orientation** drop down menu in the graphics window. Click on **Front Plane** in the **FeatureManager design tree**. Select the **Line** sketch tool.

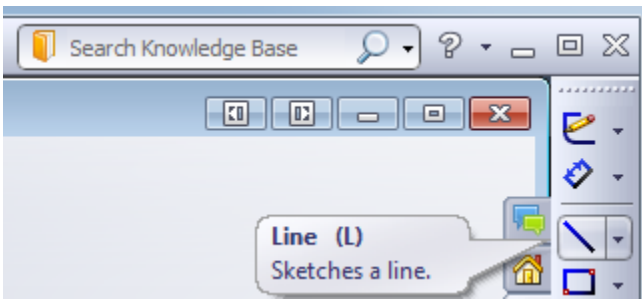



Figure 2.6 Selection of the line sketch tool

- Draw a vertical line in the Y-direction in the front plane starting at the lower inner surface of the sketch. Set the **Parameters** and **Additional Parameters** to the values shown in the figure. Close the **Line Properties** dialog  and the **Inert Line** dialog.

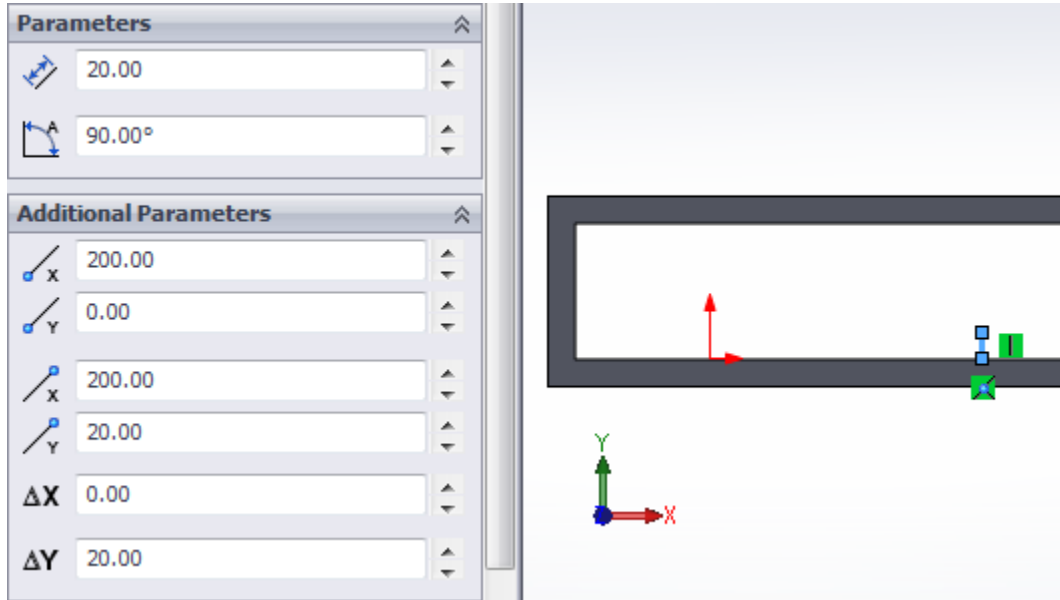



Figure 2.7 Parameters for vertical line

- Repeat step 7 three more times and add three more vertical lines to the sketch, the second line at  $X = 400$  mm with a length of 40 mm, the third line at  $X = 600$  mm with a length of 60 mm and the fourth line at  $X = 800$  mm with a length of 80 mm. These lines will be used to plot the boundary layer velocity profiles at different streamwise positions along the flat plate. Close the **Insert Line** dialog . Save the SolidWorks part with the following name: **Flat Plate Boundary Layer Study 2013**. Rename the newly created sketch in the **FeatureManager design tree**, see figure 2.8. Click on the **Rebuild** symbol  in the SolidWorks menu.

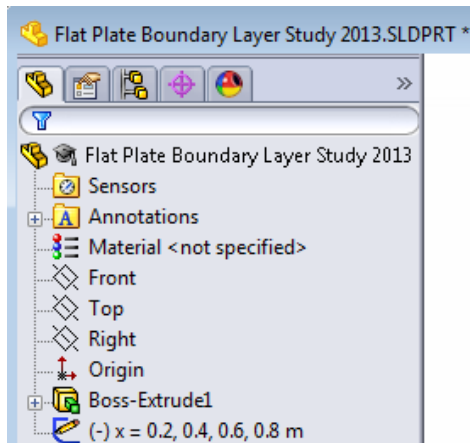

Figure 2.8 Renaming the sketch for boundary layer velocity profiles

- Repeat step 6 and draw a horizontal line in the X-direction starting at the origin of the lower inner surface of the sketch. Set the **Parameters** and **Additional Parameters** to the values shown in the figure and close the **Line Properties** dialog and the **Insert Line** dialog. Rename the sketch in the **FeatureManager design tree** and call it **x = 0 – 0.9 m**. Click on the **Rebuild** symbol.

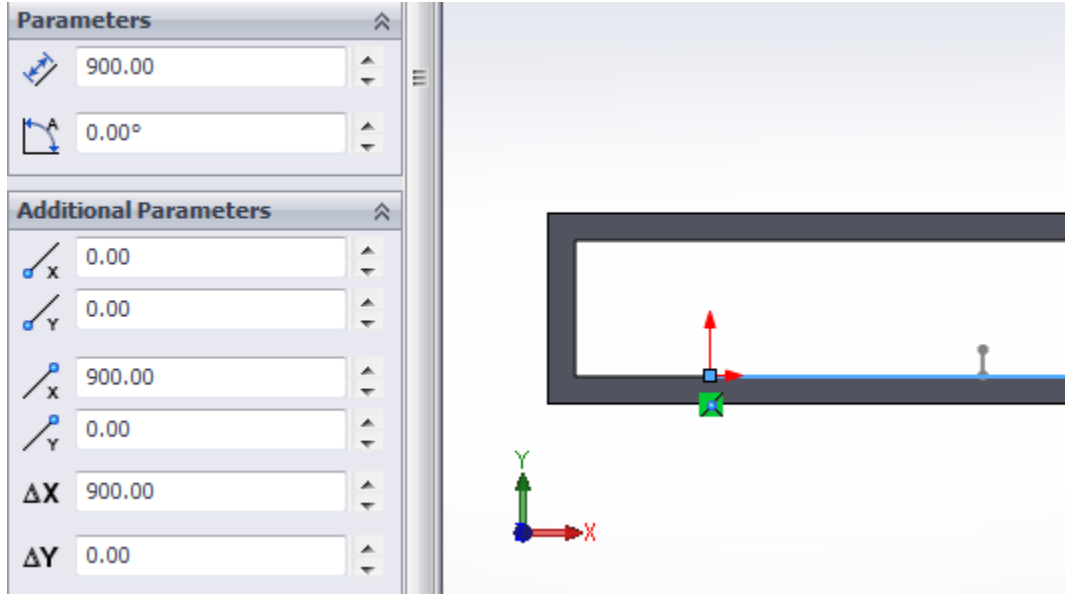

Figure 2.9 Adding a line in the X-direction

- Next, we will create a split line. Repeat step 6 once again but this time select the **Top Plane** and draw a line in the Z-direction through the origin of the lower inner surface of the sketch. It will help to zoom in and rotate the view to complete this step. Set the **Parameters** and **Additional Parameters** to the values shown in the figure and close both dialogs.

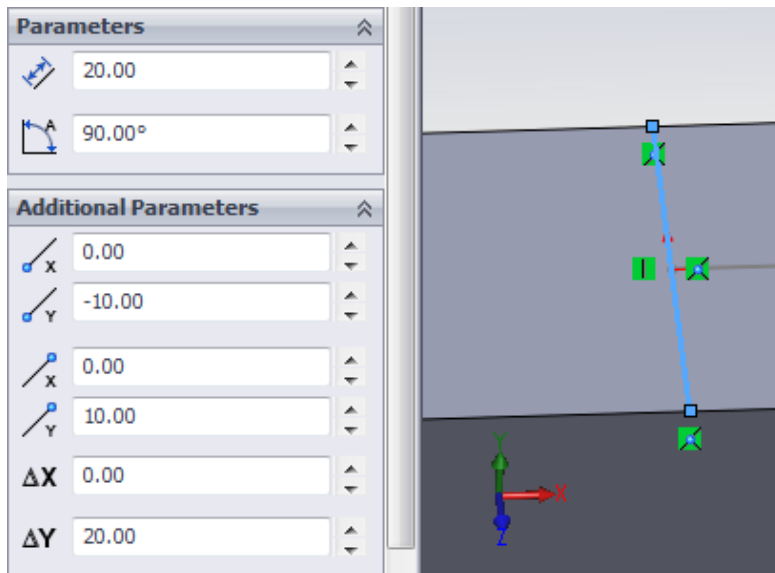



Figure 2.10 Drawing a line in the Z-direction



11. Rename the sketch in the **FeatureManager design tree** and call it **Split Line**. Click on the **Rebuild** symbol once again. Select **Insert>>Curve>>Split Line...** from the SolidWorks menu. Select **Projection** under **Type to Split**. Select Split Line for **Sketch to Project** under **Selections**. For **Faces to Split**, select the surface where you have drawn your split line, see figure 2.11b). Close the dialog . You have now finished the part for the flat plate boundary layer. Select **File>>Save** from the SolidWorks menu.

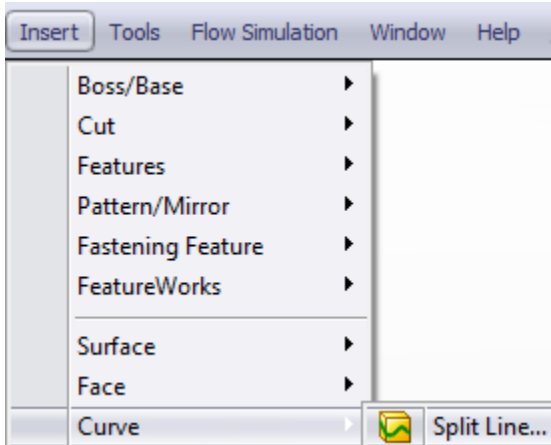

Figure 2.11a) Creating a split line

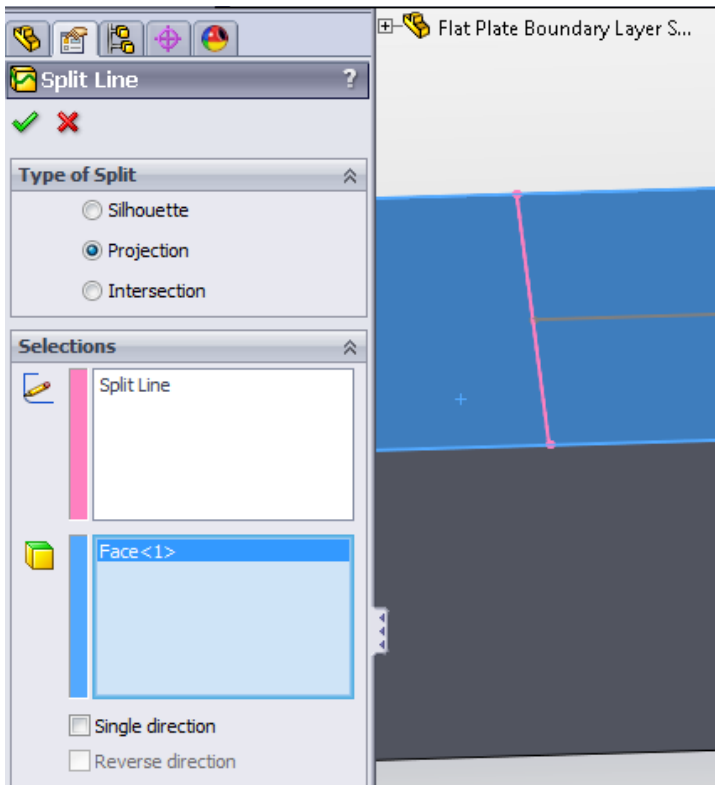

Figure 2.11b) Selection of surface for the split line

**Setting Up the Flow Simulation Project**

12. If Flow Simulation is not available in the menu, you have to add it from SolidWorks menu: **Tools>>Add Ins...** and check the corresponding **SolidWorks Flow Simulation 2013** box. Select **Flow Simulation>>Project>>Wizard** to create a new Flow Simulation project. Create a new figuration named “**Flat Plate Boundary Layer Study**”. Click on the **Next >** button. Select the default **SI (m-k-g-s)** unit system and click on the **Next>** button once again.

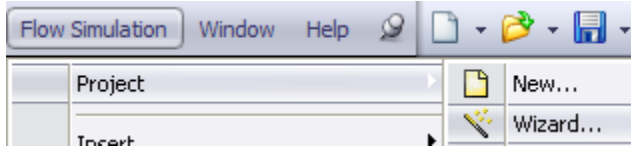

Figure 2.12a) Starting a new Flow Simulation project

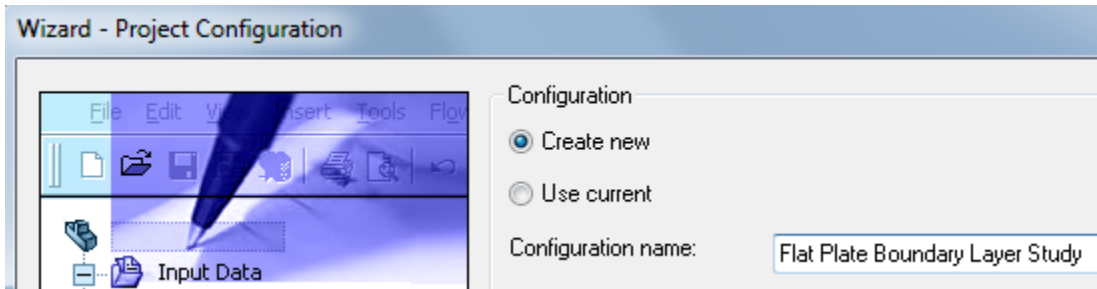

Figure 2.12b) Creating a name for the project

13. Use the default **Internal Analysis** type and click on the **Next>** button once again.

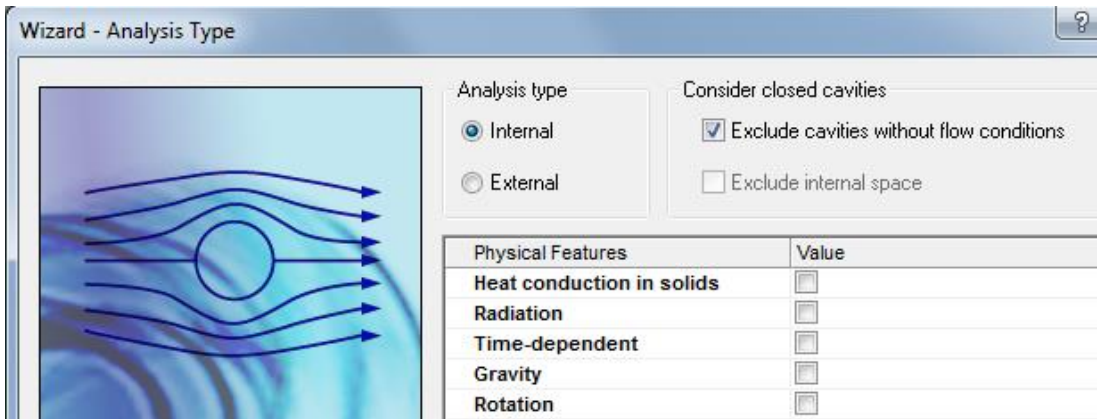

Figure 2.13 Excluding cavities without flow conditions

14. Select **Air** from the **Gases** and add it as **Project Fluid**. Select **Laminar Only** from the **Flow Type** drop down menu. Click on the **Next >** button. Use the default **Wall Conditions** and click on the **Next >** button. Insert **5 m/s** for **Velocity in X direction** as **Initial Condition** and click on the **Next >** button. Slide the **Result resolution** to **8**. Click on the **Finish** button. You will get a fluid volume recognition failure message. Answer Yes to this and all other questions and create a lid on each side of the model.

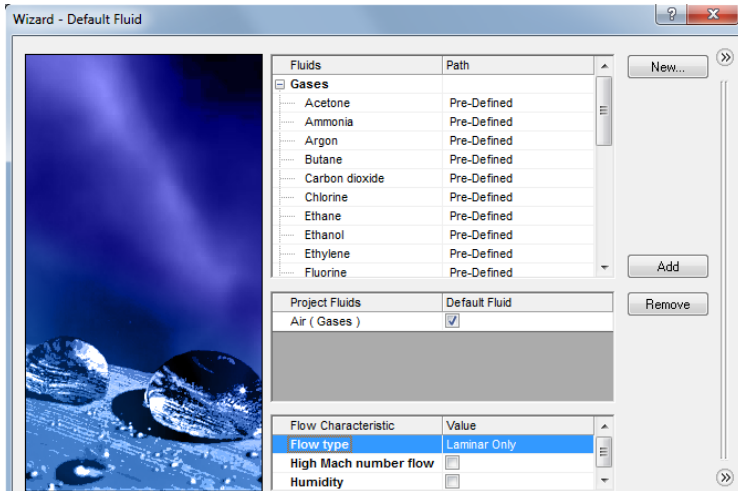

Figure 2.14a) Selection of fluid for the project and flow type

15. Select **Flow Simulation>>Computational Domain...**. Click on the **2D simulation** button under **Type** and select **XY plane**. Close the **Computational Domain** dialog .

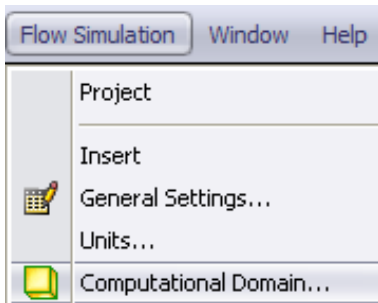

Figure 2.15a) Modifying the computational domain

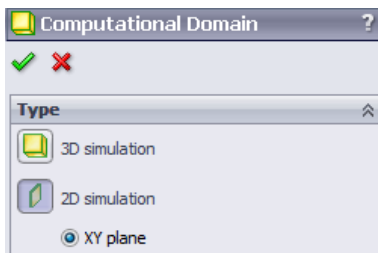

Figure 2.15b) Selecting 2D simulation in the XY plane

16. Select **Flow Simulation**>>**Initial Mesh...** Uncheck the **Automatic setting** box at the bottom of the window. Change the **Number of cells per X:** to **300**, the **Number of cells per Y:** to **200**, and the **Number of cells per Z:** to **1**. Click on the **OK** button to exit the **Initial Mesh** window.

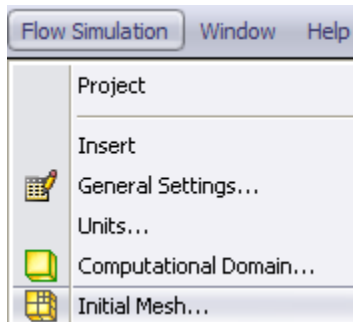

Figure 2.16a) Modifying the initial mesh

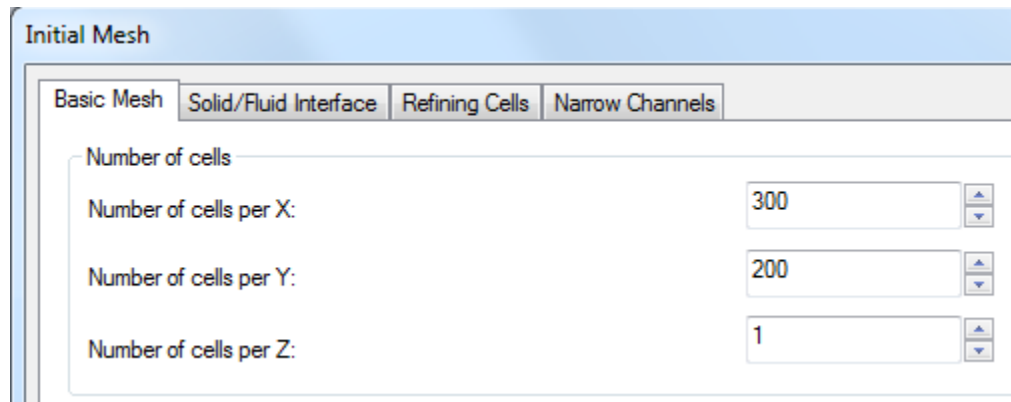





Figure 2.16b) Changing the number of cells in two directions

### Selecting Boundary Conditions

17. Select the  **Flow Simulation analysis tree** tab, open the **Input Data** folder by clicking on the plus sign next to it and right click on **Boundary Conditions**. Select **Insert Boundary Condition...** Select wireframe as the **Display Style**. Right click in the graphics window and select **Zoom/Pan/Rotate**>>**Zoom to Fit**. Once again, right click in the graphics window and select **Zoom/Pan/Rotate**>>**Rotate View**. Click and drag the mouse so that the inner surface of the left boundary is visible. Right click again and unselect **Zoom/Pan/Rotate**>>**Rotate View**. Right click on the left inflow boundary surface and select **Select Other**. Select the Face corresponding to the inflow boundary. Select **Inlet Velocity** in the **Type** portion of the **Boundary Condition** window and set the velocity to **5 m/s** in the **Flow Parameters** window. Click **OK**  to exit the window. Right click in the graphics window and select  **Zoom to Area** and select an area around the left boundary.

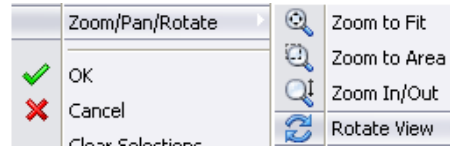
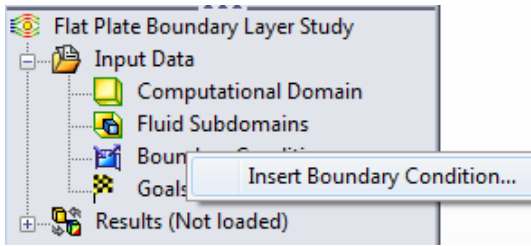

Figure 2.17a) Inserting boundary condition

Figure 2.17b) Modifying the view

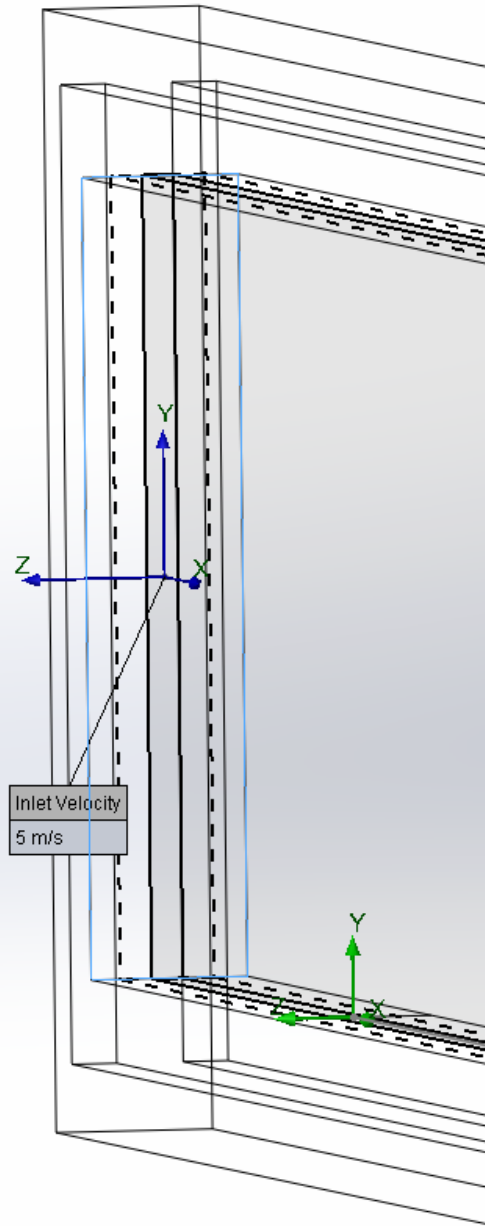
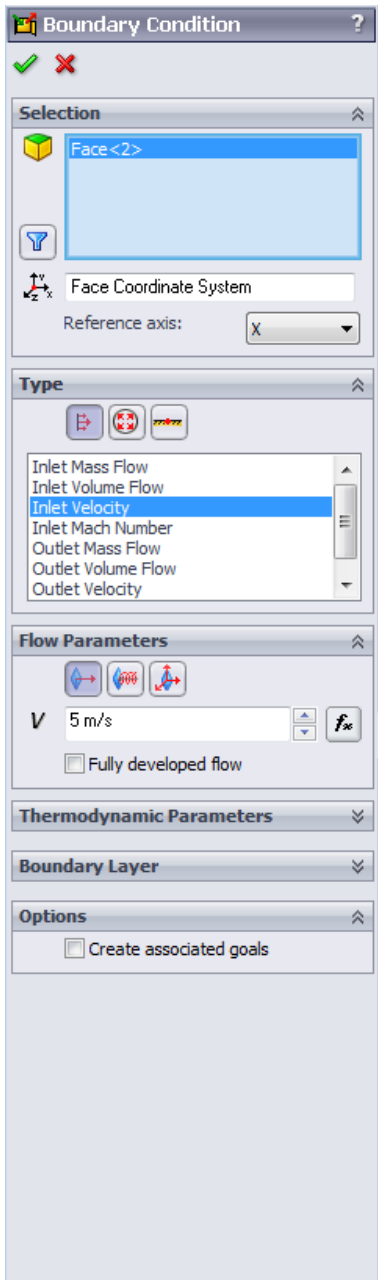

Figure 2.17c) Velocity boundary condition on the inflow

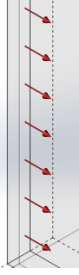





Figure 2.17d) Inlet velocity boundary condition indicated by red arrows

18. Red arrows pointing in the flow direction appears indicating the inlet velocity boundary condition, see figure 2.17d). Right click in the graphics window and select **Zoom to Fit**. Right click again in the graphics window and select  **Rotate View** once again to rotate the part so that the inner right surface is visible in the graphics window. Right click and click on  **Select**. Right click on  **Boundary Conditions** in the **Flow Simulation analysis tree** and select **Insert Boundary Condition...** Right click on the outflow boundary surface and select **Select Other**. Select the Face corresponding to the outflow boundary.. Click on the **Pressure Openings** button in the **Type** portion of the **Boundary Condition** window and select **Static Pressure**. Click OK  to exit the window. If you zoom in on the outlet boundary you will see blue arrows indicating the static pressure boundary condition, see figure 2.18b).

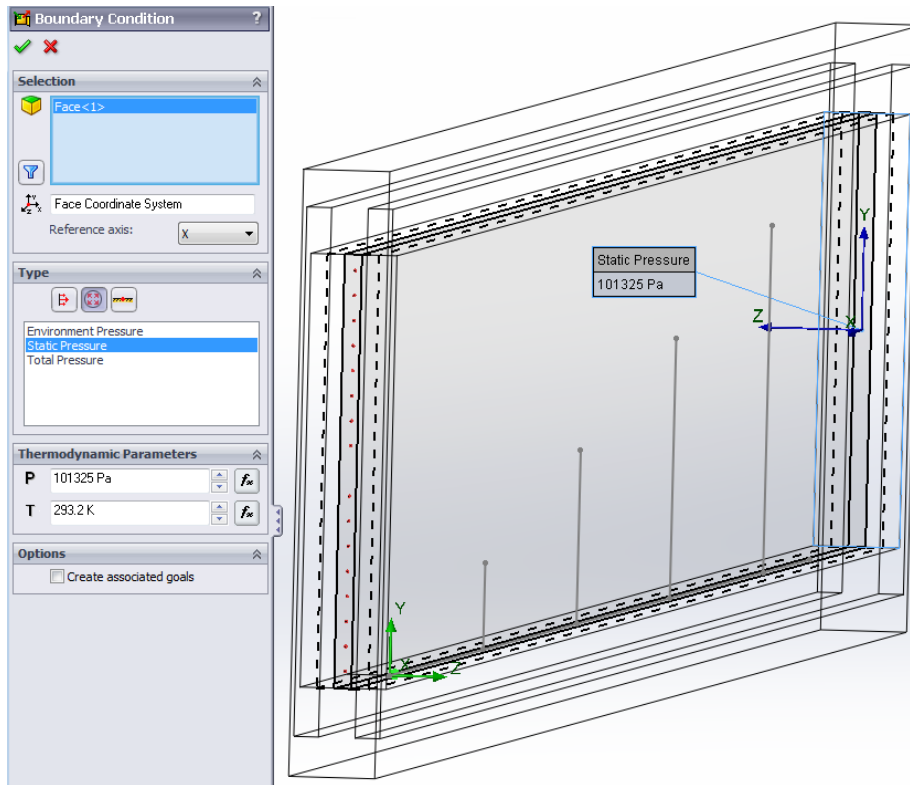

Figure 2.18a) Selection of static pressure as boundary condition at the outlet of the flow region

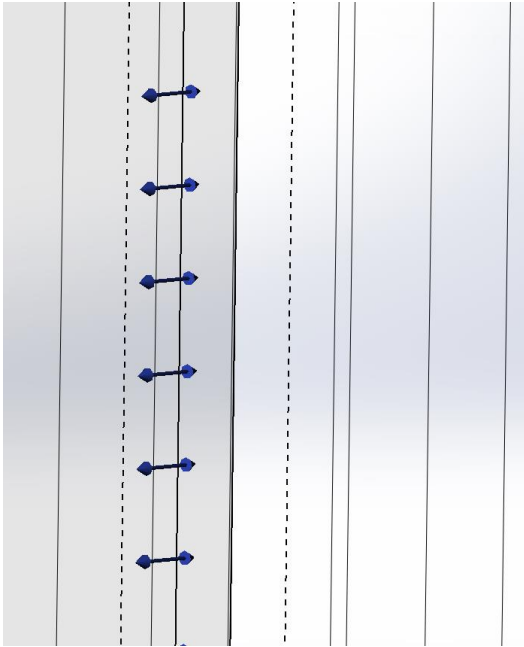

Figure 2.18b) Outlet static pressure boundary condition

19. Enter the following boundary conditions: **Ideal Wall** for the lower and upper walls at the inflow region, see figures 2.19. These will be adiabatic and frictionless walls.

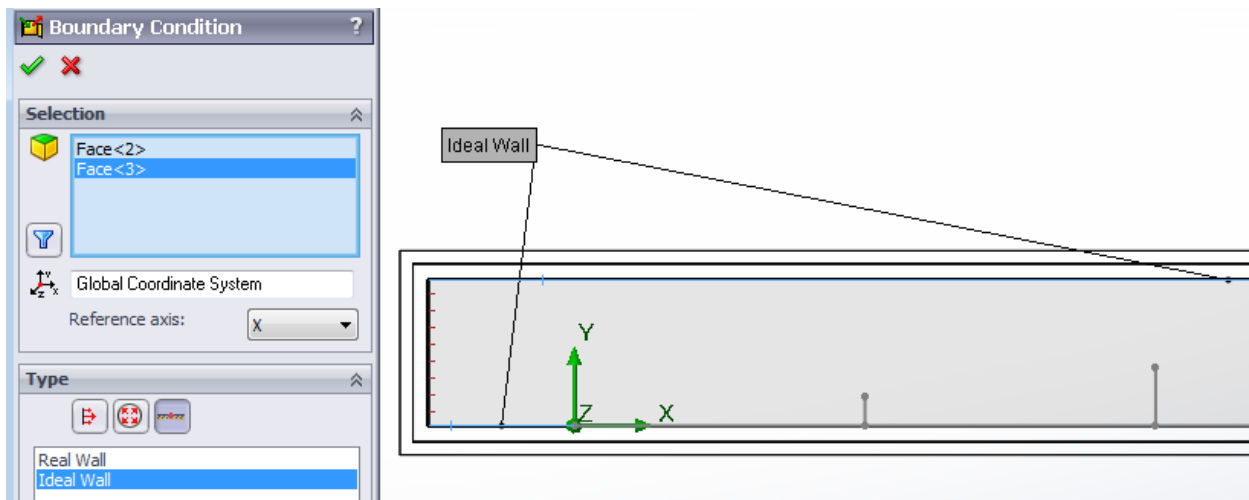

Figure 2.19 Ideal wall boundary condition for two wall sections

20. The last boundary condition will be in the form of a **Real Wall**. We will study the development of the boundary layer on this wall.

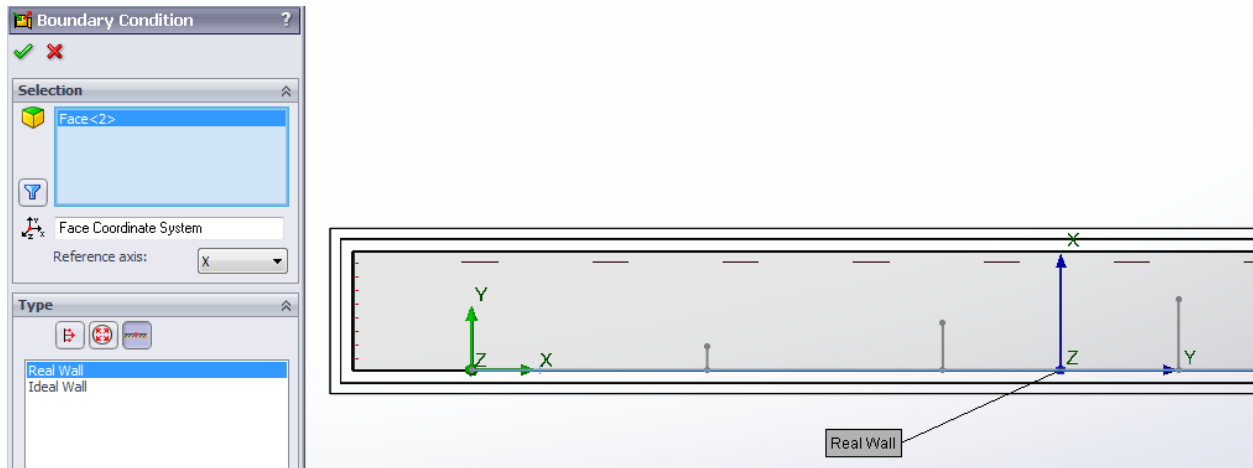



Figure 2.20 Real wall boundary condition for the flat plate

### Inserting Global Goals

21. Right click on **Goals** in the **Flow Simulation analysis tree** and select **Insert Global Goals....** Select **Friction Force (X)** as a global goal. Exit the **Global Goals** window. Right click on **Goals** in the **Flow Simulation analysis tree** and select **Insert Point Goals....** Click on the  **Point Coordinates** button. Enter **0.2 m** for X coordinate and **0.02 m** for Y coordinate and click on the **Add Point** button . Add three more points with the coordinates shown in figure 2.21e). Check the **Value** box for **Velocity (X)**. Exit the **Point Goals** window. Rename the goals as shown in figure 2.21f). Right click on **Goals** in the **Flow Simulation analysis tree** and select **Insert Equation Goal....** Click on the **Velocity (X) at x = 0.2 m** goal in the **Flow Simulation analysis tree**, multiply by  $x = 0.2 \text{ m}$  and divide by the kinematic viscosity of air at room temperature ( $\nu = 1.516\text{E-}5 \text{ m}^2/\text{s}$ ) to get an expression for the Reynolds number in the **Equation Goal** window, see figure 2.21g). Select **No units** from the dimensionality drop down menu. Click on the **OK** button to exit the **Equation Goal** window. Rename the equation goal to **Reynolds number at x = 0.2 m**. Insert three more equation goals corresponding to the Reynolds numbers at the three other  $x$  locations. For a definition of the Reynolds number, see page 2-21.



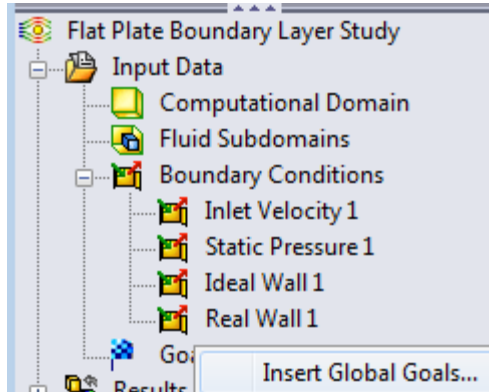

Figure 2.21a) Inserting global goals

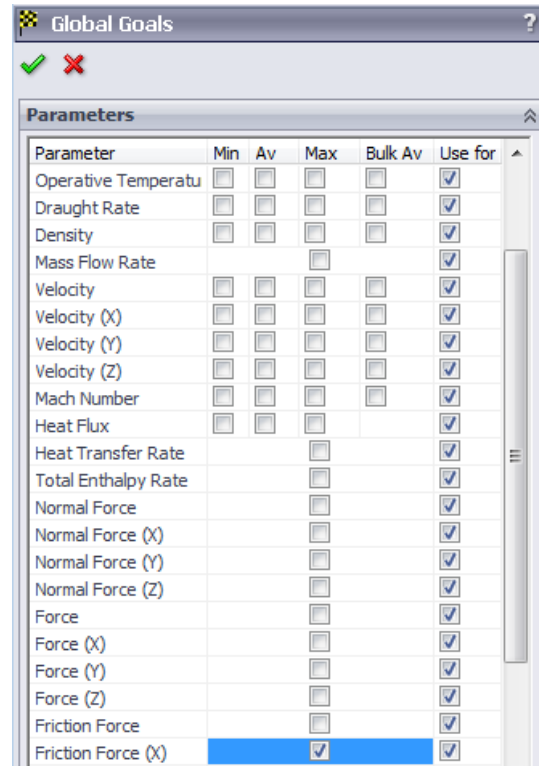

Figure 2.21b) Selection of shear force

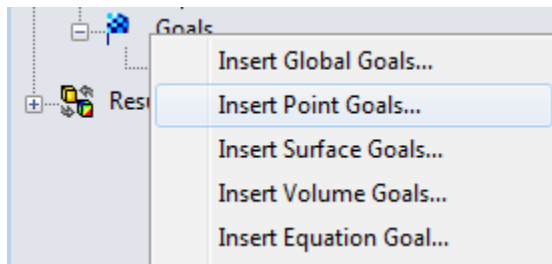

Figure 2.21c) Inserting point goals

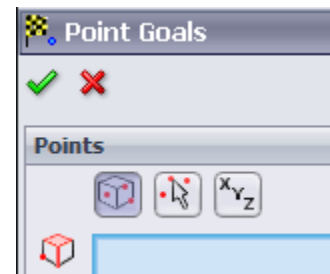

Figure 2.21d) Selecting point coordinates

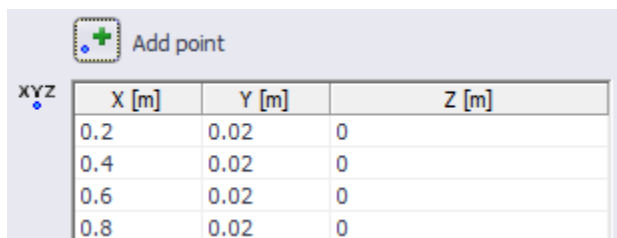

Figure 2.21e) Coordinates for point goals

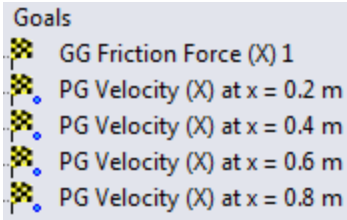

Figure 2.21f) Renaming the point goals

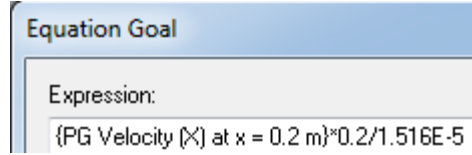

Figure 2.21g) Entering an equation goal

## Running the Calculations

22. Select **Flow Simulation>>Solve>>Run** from the SolidWorks menu to start the calculations.

Click on the **Run** button in the **Run** window. Click on the goals  button in the **Solver** window to see the **List of Goals**.

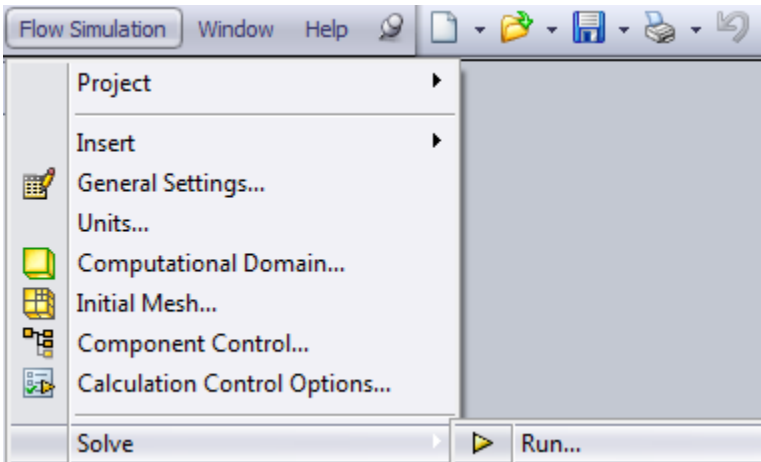

Figure 2.22a) Starting calculations

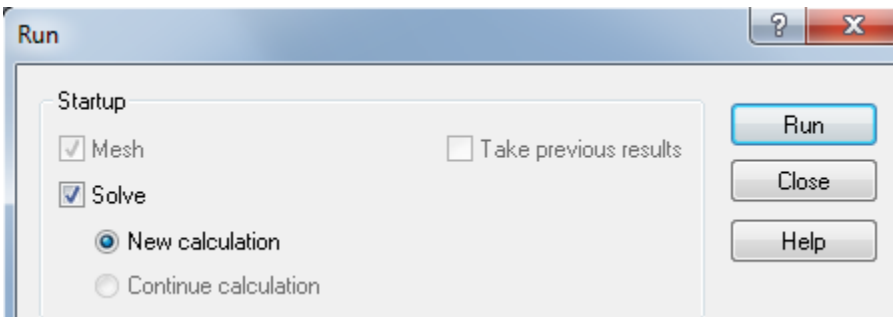

Figure 2.22b) Run window

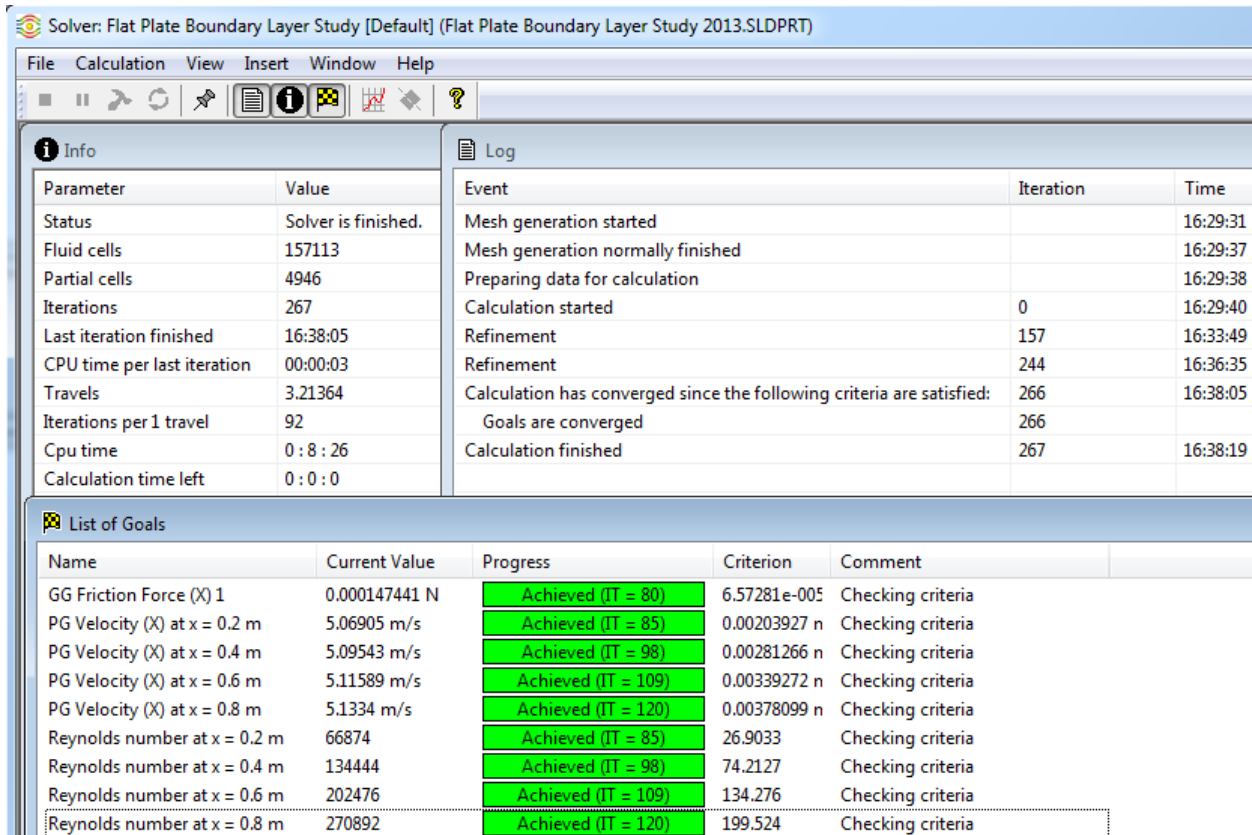





Figure 2.22c) Solver window

### Using Cut Plots to Visualize the Flow Field

- Right click on  Cut Plots in the  **Flow Simulation analysis tree** under **Results** and select **Insert....** Select the **Front Plane** from the  **FeatureManager design tree**. Slide the **Number of Levels** slide bar to 255. Select **Pressure** from the **Parameter** drop down menu. Click OK  to exit the **Cut Plot** window. Figure 2.23a) shows the high pressure region close to the leading edge of the flat plate. Rename the cut plot to **Pressure**. You can get more lighting on the cut plot by selecting **Flow Simulation>>Results>>Display>>Lighting** from the SolidWorks menu. Right click on the **Pressure Cut Plot** in the **Flow Simulation analysis tree** and select **Hide**. Repeat this step but instead choose **Velocity (X)** from the **Parameter** drop down menu. Rename the second cut plot to **Velocity (X)**. Figures 2.23b) and 2.23c) are showing the velocity boundary layer close to the wall.

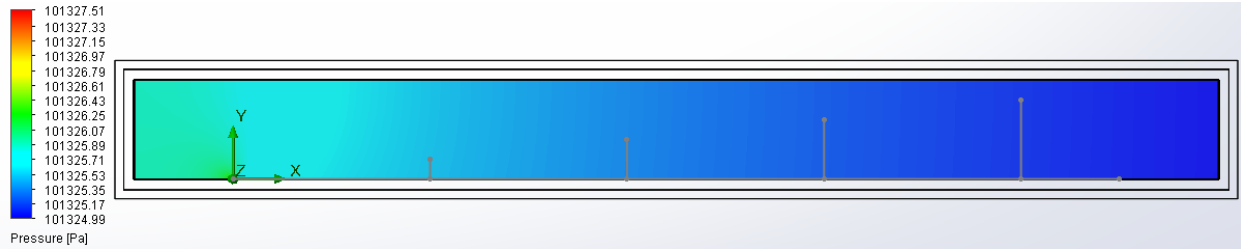

Figure 2.23a) Pressure distribution along the flat plate.

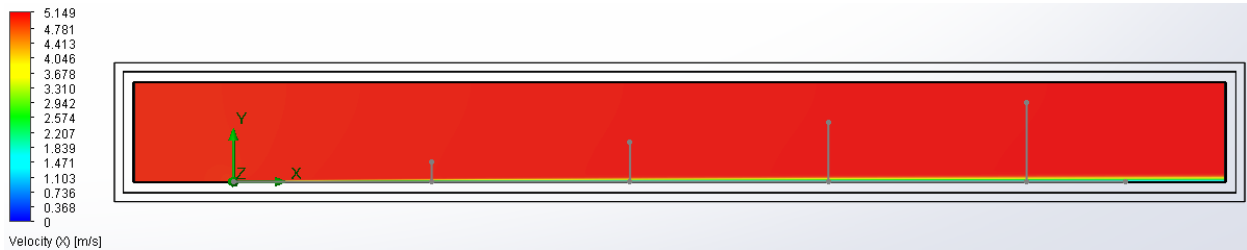



Figure 2.23b) X – Component of Velocity distribution on the flat plate.



Figure 2.23c) Close up view of the velocity boundary layer.

### Using XY Plots with Templates

24. Place the file “xy-plot figure 2.24c)” into the **Local Disk (C:)/Program Files /SolidWorks Corp/SolidWorks Flow Simulation/lang/english/template/XY-plots** folder to make it available in the **Template** list. Click on the  **FeatureManager design tree**. Click on the sketch **x = 0.2, 0.4, 0.6, 0.8 m**. Click on the  **Flow Simulation analysis tree** tab. Right click **XY Plot** and select **Insert....** Check the **Velocity (X)** box. Open the **Resolution** portion of the **XY Plot** window and slide the **Geometry Resolution** as far as it goes to the right. Click on the **Evenly Distribute Output Points** button and increase the number of points to **500**. Open the **Options** portion and check the **Display boundary layer** box. Select the template “xy-plot figure 2.24c)” from the drop down menu. Click **Export to Excel** to create the **XY Plot** window. An Excel file will open with a graph of the velocity in the boundary layer at different streamwise positions, see figure 2.24c). Rename the inserted xy-plot in the **Flow Simulation analysis tree** to **Laminar Velocity Boundary Layer**.

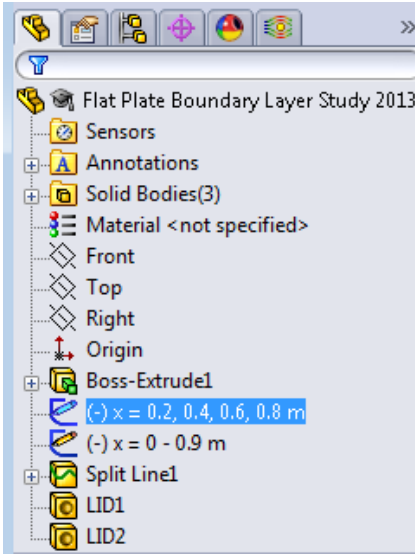

Figure 2.24a) Selecting the sketch for the XY Plot

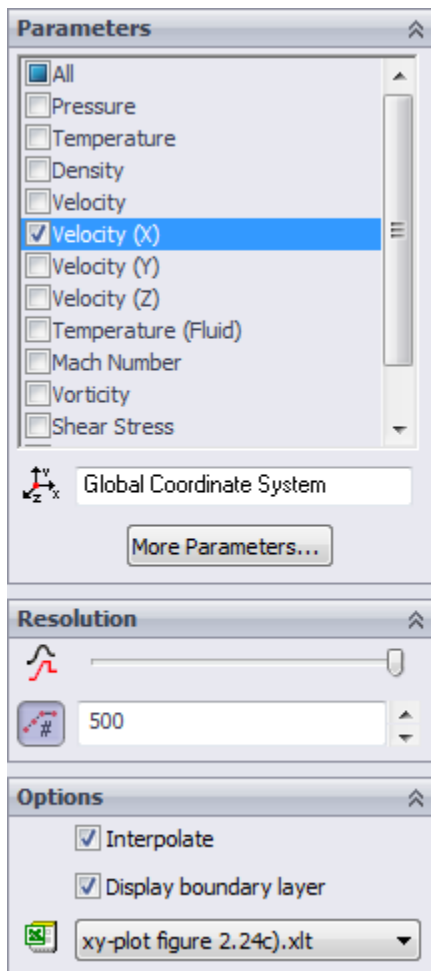

Figure 2.24b) Settings for the XY Plot

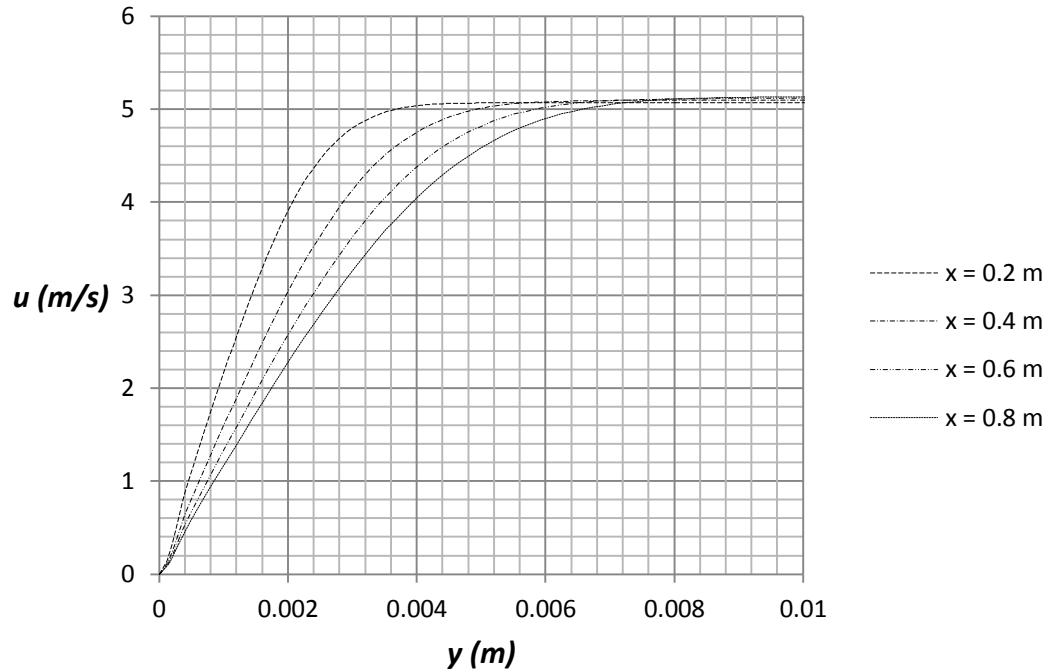

Figure 2.24c) Boundary layer velocity profiles on a flat plate at different streamwise positions

**Comparison of Flow Simulation Results with Theory and Empirical Data**

25. We now want to compare this velocity profile with the theoretical Blasius velocity profile for laminar flow on a flat plate. First, we have to normalize the streamwise X velocity component with the free stream velocity. Secondly, we have to transform the wall normal coordinate into the similarity coordinate for comparison with the Blasius profile. The similarity coordinate is described by

$$\eta = y \sqrt{\frac{U}{\nu x}} \tag{2.1}$$

where  $y$  (m) is the wall normal coordinate,  $U$  (m/s) is the free stream velocity,  $x$  (m) is the distance from the leading edge and  $\nu$  is the kinematic viscosity of the fluid.

26. Place the file “xy-plot figure 2.25a)” into the **Local Disk (C:)/Program Files /SolidWorks Corp/SolidWorks Flow Simulation/lang/english/template/XY-plots** folder to make it available in the **Template** list. Repeat step 24 and select the new template for the XY-plot. Rename the xy-plot to **Comparison with Blasius Profile**.

We see in figure 2.25a) that all profiles at different streamwise positions collapse on the same Blasius curve when we use the boundary layer similarity coordinate.

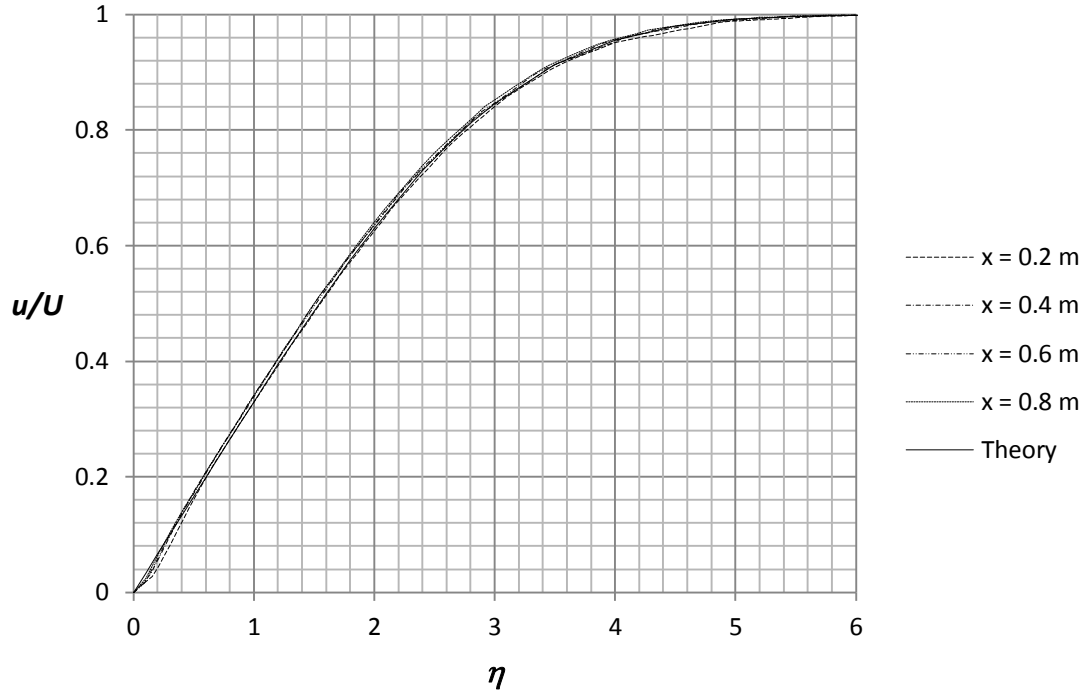

Figure 2.25a) Velocity profiles in comparison with the theoretical Blasius profile (full line)

The Reynolds number for the flow on a flat plate is defined as

$$Re_x = \frac{Ux}{\nu} \tag{2.2}$$

The boundary layer thickness  $\delta$  is defined as the distance from the wall to the location where the velocity in the boundary layer has reached 99% of the free stream value. The theoretical expression for the thickness of the laminar boundary layer is given by

$$\delta = \frac{4.91x}{\sqrt{Re_x}} \tag{2.3}$$

, and the thickness of the turbulent boundary layer

$$\delta = \frac{0.16x}{Re_x^{1/7}} \tag{2.4}$$

From the data of figure 2.24c) we can see that the thickness of the laminar boundary layer is close to 3.80 mm at  $Re_x = 66,874$  corresponding to  $x = 0.2$  m. The free stream velocity at  $x = 0.2$  m is  $U = 5.069$  m/s, see figure 2.22c) for list of goals in solver window, and 99% of this value is  $U_\delta =$

5.018 m/s. The boundary layer thickness  $\delta = 3.80$  mm from Flow Simulation was found by finding the  $y$  position corresponding to the  $U_\delta$  velocity. This value for  $\delta$  at  $x = 0.2$  m and corresponding values further downstream at different  $x$  locations are available in the Plot Data for Figure 2.25a). The different values of the boundary layer thickness can be compared with values obtained using equation (3). In table 2.1 are comparisons shown between boundary layer thickness from Flow Simulation and theory corresponding to the four different Reynolds numbers shown in figure 2.24c). The Reynolds number varies between  $Re_x = 66,874$  at  $x = 0.2$  m and  $Re_x = 270,892$  at  $x = 0.8$  m.

x (m)	$\delta$ (mm) Simulation	$\delta$ (mm) Theory	Percent (%) Difference	$U_\delta$ (m/s)	$U$ (m/s)	$\nu$ ( $\frac{m^2}{s}$ )	$Re_x$
0.2	3.80	3.80	0.1	5.018	5.069	0.00001516	66,874
0.4	5.33	5.36	0.5	5.044	5.095	0.00001516	134,444
0.6	6.46	6.55	1.3	5.065	5.116	0.00001516	202,476
0.8	7.44	7.55	1.5	5.082	5.133	0.00001516	270,892

Table 2.1 Comparison between Flow Simulation and theory for laminar boundary layer thickness

27. Place the file “xy-plot figure 2.25b)” into the **Local Disk (C:)/Program Files /SolidWorks Corp/SolidWorks Flow Simulation/lang/english/template/XY-plots** folder to make it available in the **Template** list. Repeat step 24 and select the new template for the XY-plot as shown in figure 2.25b). Rename the xy-plot to **Boundary Layer Thickness**.

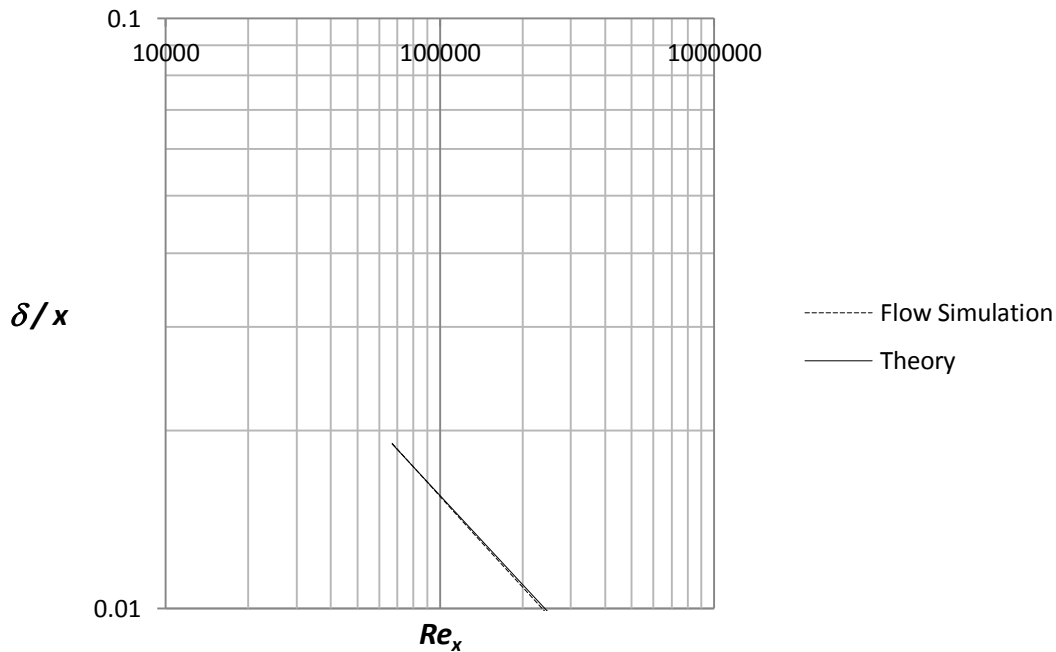

Figure 2.25b) Comparison between Flow Simulation and theory on boundary layer thickness

The displacement thickness is defined as the distance that a streamline outside of the boundary layer is deflected by the boundary layer and is given by the following integral



$$\delta^* = \int_0^{\infty} \left(1 - \frac{u}{U}\right) dy \tag{2.5}$$

The theoretical expression for the displacement thickness of the laminar boundary layer is given by

$$\frac{\delta^*}{x} = \frac{1.72}{\sqrt{Re_x}} \tag{2.6}$$

and the displacement thickness of the turbulent boundary layer

$$\frac{\delta^*}{x} = \frac{0.02}{Re_x^{1/7}} \tag{2.7}$$

x (m)	$\delta^*$ (mm) Simulation	$\delta^*$ (mm) Theory	Percent (%) Difference	$Re_x$
0.2	1.3342	1.3302	0.3	66,874
0.4	1.8411	1.8763	1.9	134,444
0.6	2.2365	2.2935	2.5	202,476
0.8	2.5657	2.6439	3.0	270,892

Table 2.2 Comparison between Flow Simulation and theory for laminar displacement thickness

Place the file “xy-plot figure 2.25c)” into the **Local Disk (C:)/Program Files /SolidWorks Corp/SolidWorks Flow Simulation/lang/english/template/XY-Plots** folder to make it available in the **Template** list. Repeat step 24 and select the new template for the XY-plot as shown in figure 2.25c). Rename the xy-plot to **Displacement Thickness**.

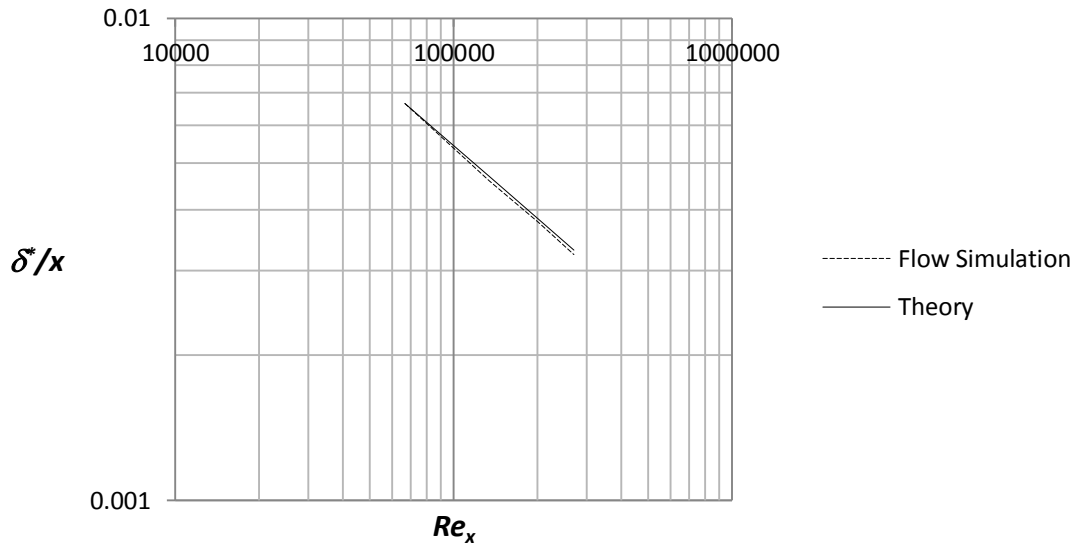

Figure 2.25c) Comparison between Flow Simulation and theory on displacement thickness

The momentum thickness is related to the loss of momentum flux caused by the boundary layer. The momentum thickness is defined by an integral similar to the one for displacement thickness

$$\theta = \int_0^{\infty} \frac{u}{U} \left(1 - \frac{u}{U}\right) dy \tag{2.8}$$

The theoretical expression for the momentum thickness of the laminar boundary layer is given by

$$\frac{\theta}{x} = \frac{0.664}{\sqrt{Re_x}} \tag{2.9}$$

and the momentum thickness of the turbulent boundary layer

$$\frac{\theta}{x} = \frac{0.016}{Re_x^{1/7}} \tag{2.10}$$

x (m)	$\theta$ (mm) Simulation	$\theta$ (mm) Theory	Percent (%) Difference	$Re_x$
0.2	0.5096	0.5135	0.8	66,874
0.4	0.7080	0.7244	2.3	134,444
0.6	0.8661	0.8854	2.2	202,476
0.8	0.9970	1.0207	2.3	270,892

Table 2.3 Comparison between Flow Simulation and theory for laminar momentum thickness

Place the file “xy-plot figure 2.25d)” into the **Local Disk (C:)/Program Files /SolidWorks Corp/SolidWorks Flow Simulation/lang/english/template/XY-Plots** folder to make it available in the **Template** list. Repeat step 24 and select the new template for the XY-plot as shown in figure 2.25d). Rename the xy-plot to **Momentum Thickness**.

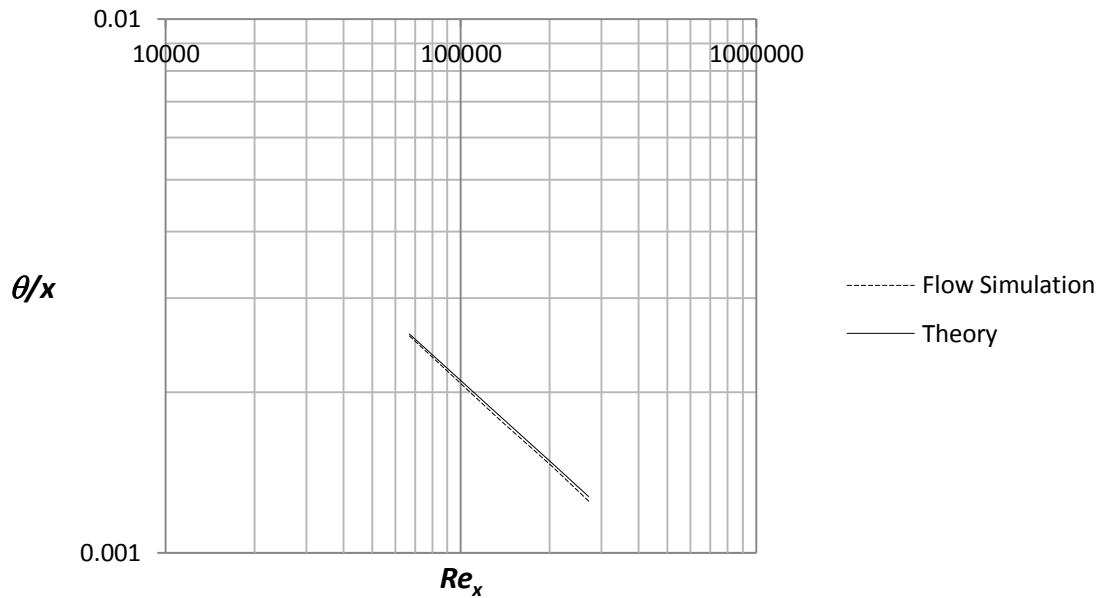

Figure 2.25d) Comparison between Flow Simulation and theory on momentum thickness

Finally, we have the shape factor that is defined as the ratio of the displacement thickness and the momentum thickness.

$$H = \frac{\delta^*}{\theta} \tag{2.11}$$

The theoretical value of the shape factor is  $H = 2.59$  for the laminar boundary layer and  $H = 1.25$  for the turbulent boundary layer.

x (m)	H Simulation	H Theory	Percent (%) Difference	Re <sub>x</sub>
0.2	2.6181	2.59	1.1	66,874
0.4	2.6004	2.59	0.4	134,444
0.6	2.5823	2.59	0.3	202,476
0.8	2.5734	2.59	0.6	270,892

Table 2.4 Comparison between Flow Simulation and theory for laminar shape factor

28. We now want to study how the local friction coefficient varies along the plate. It is defined as the local wall shear stress divided by the dynamic pressure:

$$C_{f,x} = \frac{\tau_w}{\frac{1}{2}\rho U^2} \tag{2.12}$$

The theoretical local friction coefficient for laminar flow is given by

$$C_{f,x} = \frac{0.664}{\sqrt{Re_x}} \quad Re_x < 5 \cdot 10^5 \tag{2.13}$$

and for turbulent flow

$$C_{f,x} = \frac{0.027}{Re_x^{1/7}} \quad 5 \cdot 10^5 \leq Re_x \leq 10^7 \tag{2.14}$$

Place the file “xy-plot figure 2.26” into the **Local Disk (C:)/Program Files /SolidWorks Corp/SolidWorks Flow Simulation/lang/english/template/XY-Plots** folder to make it available in the **Template** list. Repeat step 24 but this time choose the sketch **x = 0 – 0.9 m**, uncheck the box for **Velocity (X)** and check the box for **Shear Stress**. Rename the xy-plot to **Local Friction Coefficient**. An Excel file will open with a graph of the local friction coefficient versus the Reynolds number compared with theoretical values for laminar boundary layer flow.

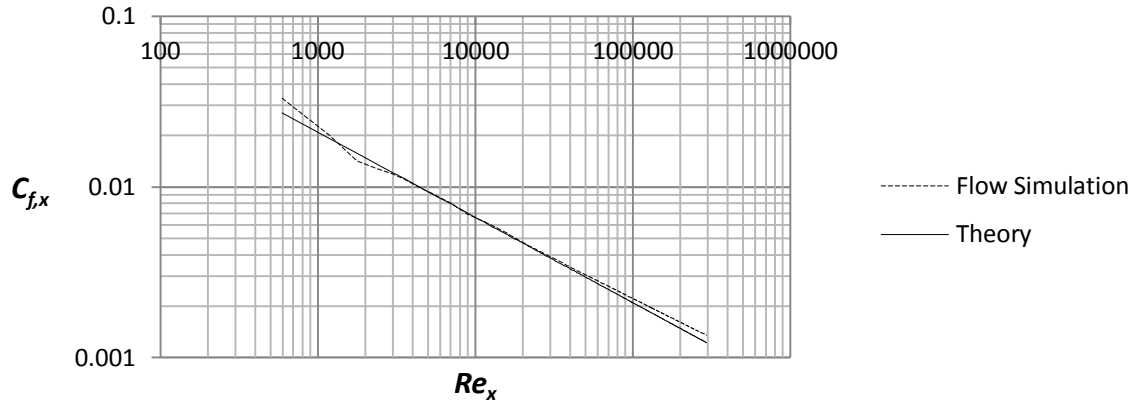

Figure 2.26 Local friction coefficient as a function of the Reynolds number

The average friction coefficient over the whole plate  $C_f$  is not a function of the surface roughness for the laminar boundary layer but a function of the Reynolds number based on the length of the plate  $Re_L$ , see figure E3 in Exercise 8 at the end of this chapter. This friction coefficient can be determined in Flow Simulation by using the final value of the global goal, the X-component of the Shear Force  $F_f$ , see figure 2.22c) and dividing it by the dynamic pressure times the area  $A$  in the X-Z plane of the computational domain related to the flat plate.

$$C_f = \frac{F_f}{\frac{1}{2}\rho U^2 A} = \frac{0.0001474N}{\frac{1}{2} \cdot 1.204kg/m^3 \cdot 5^2 m^2/s^2 \cdot 1m \cdot 0.004m} = 0.002448 \quad (2.15)$$

$$Re_L = \frac{UL}{\nu} = \frac{5m/s \cdot 1m}{1.516 \cdot 10^{-5} m^2/s} = 3.3 \cdot 10^5 \quad (16)$$

The average friction coefficient from Flow Simulation can be compared with the theoretical value for laminar boundary layers

$$C_f = \frac{1.328}{\sqrt{Re_L}} = 0.002312 \quad Re_L < 5 \cdot 10^5 \quad (2.17)$$

This is a difference of 5.3 %. For turbulent boundary layers the corresponding expression is

$$C_f = \frac{0.0315}{Re_L^{1/7}} \quad 5 \cdot 10^5 \leq Re_L \leq 10^7 \quad (2.18)$$

If the boundary layer is laminar on one part of the plate and turbulent on the remaining part the average friction coefficient is determined by

$$C_f = \frac{0.0315}{Re_L^{1/7}} - \frac{1}{Re_L} \left( 0.0315 Re_{cr}^{6/7} - 1.328 \sqrt{Re_{cr}} \right) \quad (2.19)$$

where  $Re_{cr}$  is the critical Reynolds number for laminar to turbulent transition.

**Cloning of the Project**

29. In the next step, we will clone the project. Select **Flow Simulation>>Project>>Clone Project...** Create a new project with the name “**Flat Plate Boundary Layer Study Using Water**”. **Create New Configuration** and click on the **OK** button to exit the **Clone Project** window. Next, change the fluid to water in order to get higher Reynolds numbers. Start by selecting **Flow Simulation>>General Settings...** from the SolidWorks menu. Click on **Fluids** in the **Navigator** portion and click on the **Remove** button. Select **Water** from the **Liquids** and **Add** it as the **Project Fluid**. Change the **Flow type** to **Laminar and Turbulent**, see figure 2.27d). Click on the **OK** button to close the **General Setting** window.

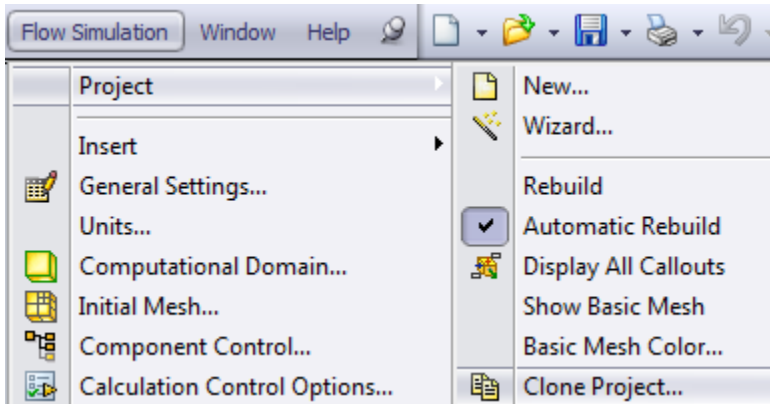

Figure 2.27a) Cloning the project

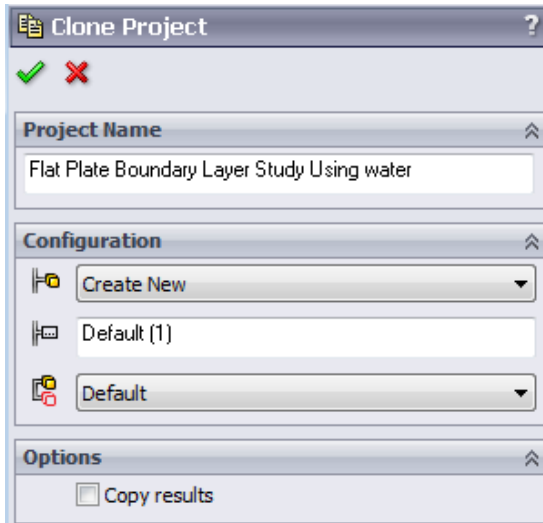

Figure 2.27b) Creating a new project

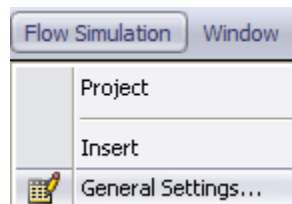

Figure 2.27c) Selection of general settings

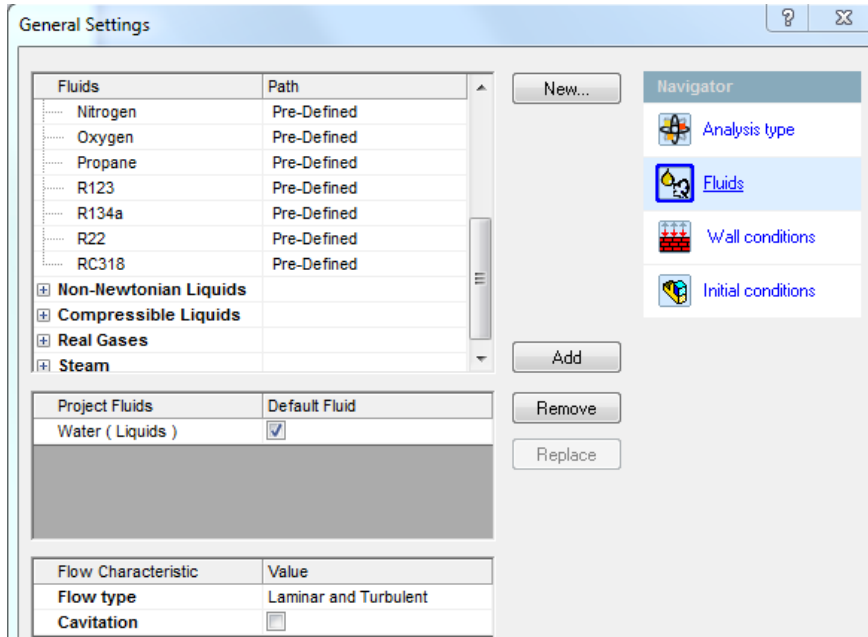

Figure 2.27d) Selection of fluid and flow type

30. Select **Flow Simulation>>Computational Domain...** Set the size of the computational domain to the values shown in figure 2.28a). Click on the **OK** button to exit. Select **Flow Simulation>>Initial Mesh...** from the SolidWorks menu and change the **Number of cells per X:** to **400** and the **Number of Cells per Y:** to **200**. Also, in the **Control intervals** portion of the window, change the **Ratio for X1** to **-5** and the **Ratio for Y1** to **-100**. This is done to increase the number of cells close to the wall where the velocity gradient is high. Click on the **OK** button to exit. Select **Flow Simulation>>Calculation Control Options...** from the SolidWorks menu. Change the **Maximum travels** value to **5** by first changing to **Manual** from the drop down menu. Travel is a unit characterizing the duration of the calculation. Click on the **OK** button to exit.



Figure 2.28a) Setting the size of the computational domain

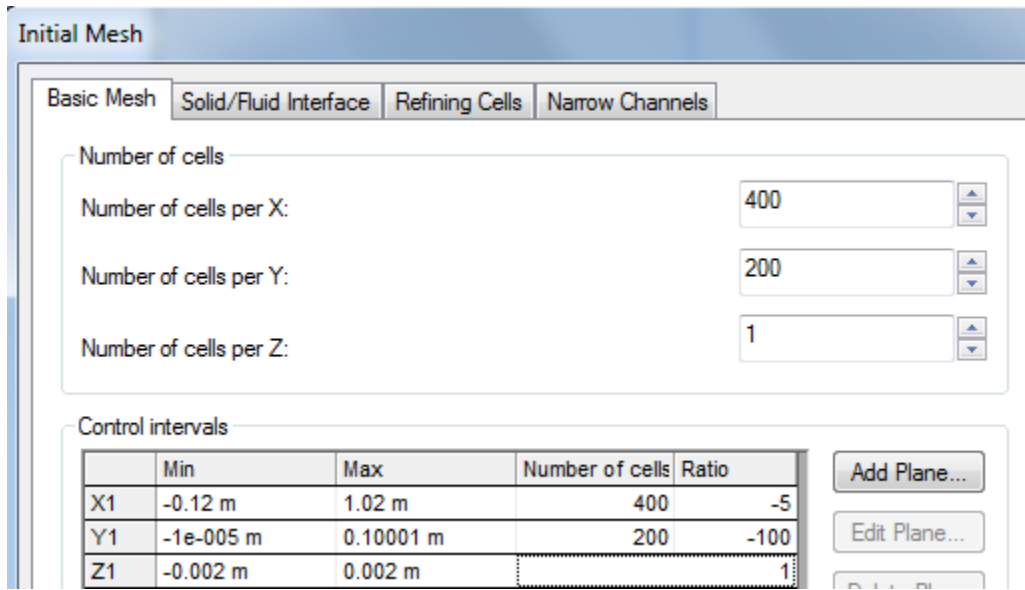

Figure 2.28b) Increasing the number of cells and the distribution of cells

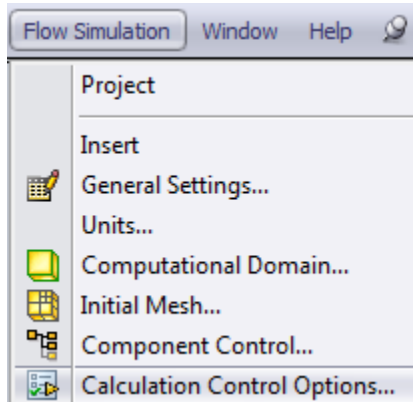

Figure 2.28c) Calculation control options

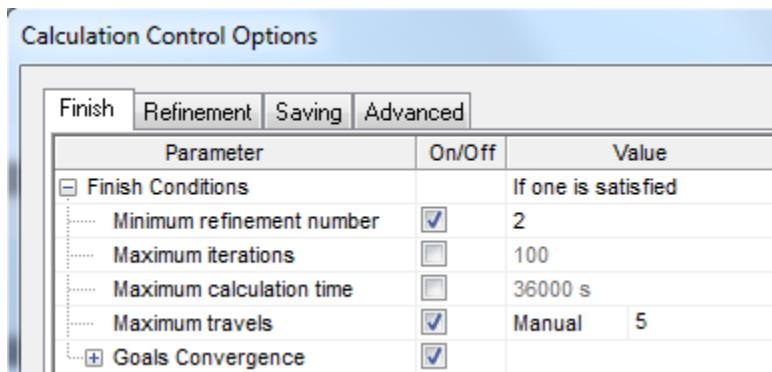

Figure 2.28d) Setting maximum travels

Select **Flow Simulation>>Project>>Show Basic Mesh** from the SolidWorks menu. We can see in figure 2.28f) that the density of the mesh is much higher close to the flat plate at the bottom wall in the figure as compared to the region further away from the wall.

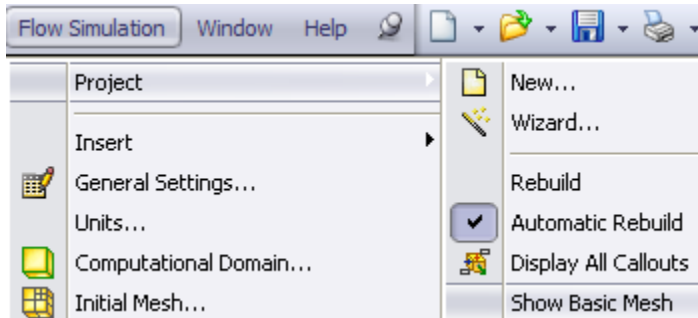

Figure 2.28e) Showing the basic mesh

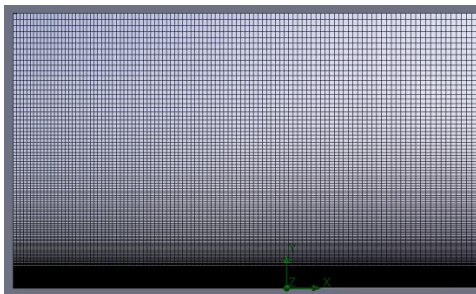



Figure 2.28f) Mesh distribution in the X-Y plane

31. Right click the **Inlet Velocity Boundary Condition** in the **Flow Simulation analysis tree** and select **Edit Definition...** Open the **Boundary Layer** section and select **Laminar Boundary Layer**. Click **OK**  to exit the **Boundary Condition** window. Right click the **Reynolds number at x = 0.2 m** goal and select **Edit Definition...** Change the viscosity value in the **Expression** to **1.004E-6**. Click on the **OK** button to exit. Change the other three equation goals in the same way. Select **Flow Simulation>>Solve>>Run** to start calculations. Click on the **Run** button in the **Run** window.

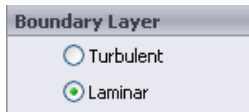

Figure 2.29a) Selecting a laminar boundary layer

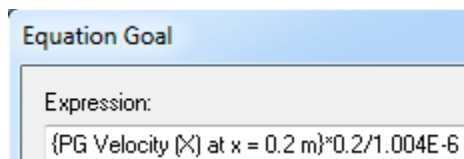

Figure 2.29b) Modifying the equation goals



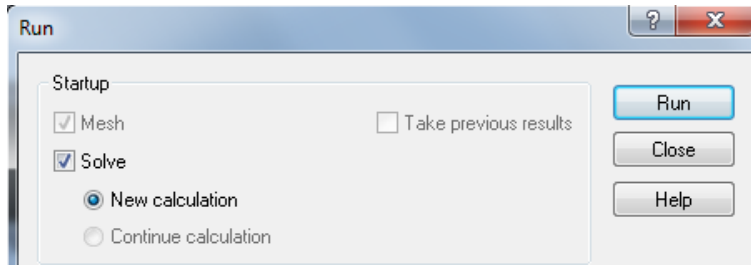

Figure 2.29c) Creation of mesh and starting a new calculation

Solver: Flat Plate Boundary Layer Study Using water [Default (1)] (Flat Plate Boundary Layer Study 2013.SLDPRT)

File Calculation View Insert Window Help

Parameter	Value
Status	Solver is finished.
Fluid cells	181676
Partial cells	5862
Iterations	302
Last iteration finished	18:15:34
CPU time per last iteration	00:00:05
Travels	3.21678
Iterations per 1 travel	108
Cpu time	0 : 16 : 40
Calculation time left	0 : 0 : 0

Event	Iteration	Time
Mesh generation started		17:58:46
Mesh generation normally finished		17:58:53
Preparing data for calculation		17:58:55
Calculation started	0	17:58:56
Refinement	173	18:06:37
Refinement	277	18:13:10
Calculation has converged since the following criteria are satisfied:	301	18:15:34
Goals are converged	301	
Calculation finished	302	18:15:52

Name	Current Value	Progress	Criterion	Comment
GG Friction Force (X) 1	0.148421 N	Achieved (IT = 97)	0.026613 N	Checking criteria
PG Velocity (X) at x = 0.2 m	5.02371 m/s	Achieved (IT = 115)	0.00069036 n	Checking criteria
PG Velocity (X) at x = 0.4 m	5.04152 m/s	Achieved (IT = 144)	0.00111084 n	Checking criteria
PG Velocity (X) at x = 0.6 m	5.0573 m/s	Achieved (IT = 161)	0.00133486 n	Checking criteria
PG Velocity (X) at x = 0.8 m	5.07185 m/s	Achieved (IT = 172)	0.00142425 n	Checking criteria
Reynolds number at x = 0.2 m	1.00074e+006	Achieved (IT = 115)	137.522	Checking criteria
Reynolds number at x = 0.4 m	2.00857e+006	Achieved (IT = 144)	442.565	Checking criteria
Reynolds number at x = 0.6 m	3.02229e+006	Achieved (IT = 161)	797.724	Checking criteria
Reynolds number at x = 0.8 m	4.04132e+006	Achieved (IT = 172)	1134.86	Checking criteria

Figure 2.29d) Solver window and goals table for calculations of turbulent boundary layer

32. Place the file “xy-plot figure 2.30a)” into the **Local Disk (C:)/Program Files /SolidWorks Corp/SolidWorks Flow Simulation/lang/english/template/XY-Plots** folder to make it available in the **Template** list. Repeat step 24 and choose the sketch **x = 0.2, 0.4, 0.6, 0.8 m** and check the box for **Velocity (X)**. Rename the xy-plot to **Turbulent Velocity Boundary Layer**. An Excel file will open with a graph of the streamwise velocity component versus the wall normal coordinate, see figure 2.30a). We see that the boundary layer thickness is much higher than the corresponding laminar flow case. This is related to higher Reynolds number at the same streamwise positions as in the laminar case. The higher Reynolds numbers are due to the selection of water as the fluid instead of air that has a much higher value of kinematic viscosity than water.

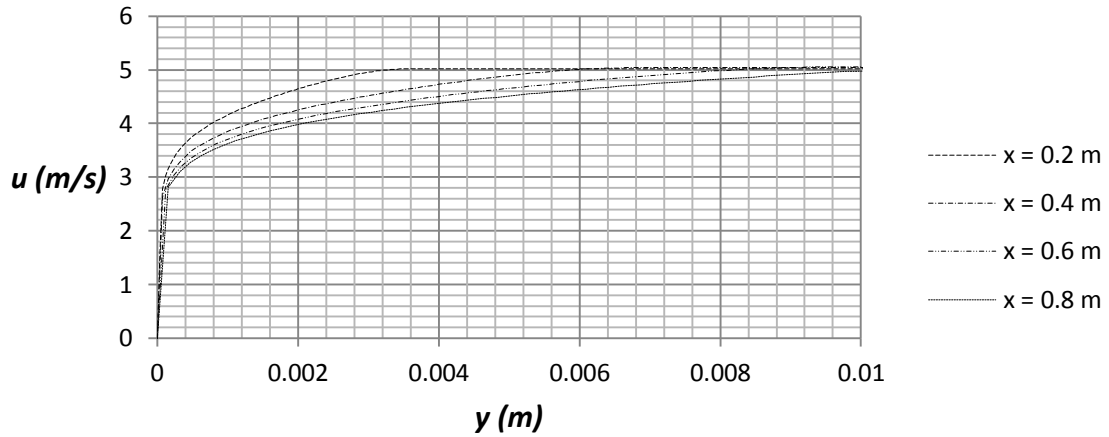

Figure 2.30a) Flow Simulation comparison between turbulent boundary layers at  $Re_x = 10^6 - 4.1 \cdot 10^6$

As an example, the turbulent boundary layer thickness from figure 2.30a) is 4.45 mm at  $x = 0.2$  m which can be compared with a value of 4.44 mm from equation (4), see table 2.5.

	$\delta$ (mm) Simulation	$\delta$ (mm) Empirical	Percent (%) Difference	$U$ (m/s)	$\nu$ ( $\frac{m^2}{s}$ )	$Re_x$
$x = 0.2$ m	3.55	4.44	20	5.024	0.000001004	1,000,740
$x = 0.4$ m	7.12	8.04	12	5.042	0.000001004	2,008,570
$x = 0.6$ m	10.33	11.38	9	5.057	0.000001004	3,022,290
$x = 0.8$ m	16.47	14.55	13	5.072	0.000001004	4,041,320

Table 2.5 Comparison between Flow Simulation and empirical results for turbulent boundary layer thickness

Place the file “xy-plot figure 2.30b)” into the **Local Disk (C:)/Program Files /SolidWorks Corp/SolidWorks Flow Simulation/lang/english/template/XY-Plots** folder to make it available in the **Template** list. Repeat step 24 and choose the sketch **x = 0.2, 0.4, 0.6, 0.8 m** and check the box for **Velocity (X)**. Rename the xy-plot to **Turbulent Boundary Layer Thickness**. An Excel file will open with a graph of the boundary layer thickness versus the Reynolds number, see figure 2.30b).

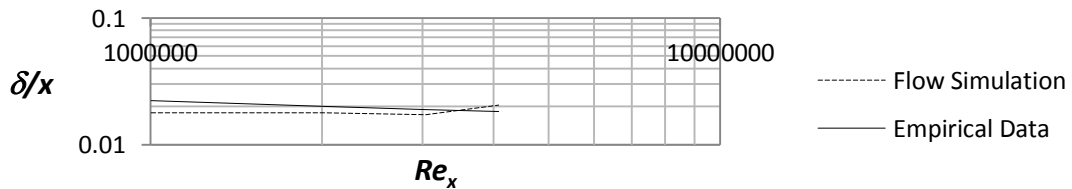

Figure 2.30b) Boundary layer thickness for turbulent boundary layers at  $Re_x = 10^6 - 4.1 \cdot 10^6$

33. Place the file “xy-plot figure 2.31” into the **Local Disk (C:)/Program Files /SolidWorks Corp/SolidWorks Flow Simulation/lang/english/template/XY-Plots** folder to make it available in the **Template** list. Repeat step 24 and choose the sketch  $x = 0.2, 0.4, 0.6, 0.8$  m and check the box for **Velocity (X)**. Rename the xy-plot to **Comparison with One-Sixth Power Law**. An Excel file will open with figure 2.31. In figure 2.31 we compare the results from Flow Simulation with the turbulent profile for  $n = 6$ . The power –law turbulent profiles suggested by Prandtl are given by

$$\frac{u}{U} = \left(\frac{y}{\delta}\right)^{1/n} \quad (2.20)$$

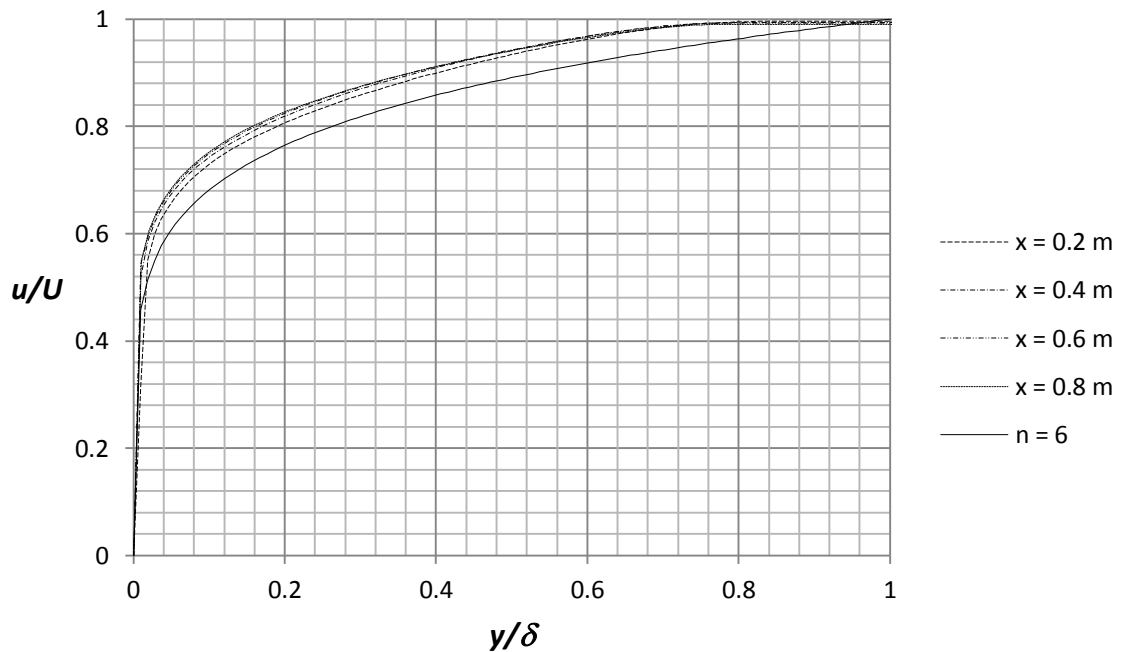

Figure 2.31 The same profiles as in figure 2.30a) compared with one-sixth power law for turbulent profile.

34. Place the file “xy-plot figure 2.32” into the **Local Disk (C:)/Program Files /SolidWorks Corp/SolidWorks Flow Simulation/lang/english/template/XY-Plots** folder to make it available in the **Template** list. Repeat step 24 and choose the sketch  $x = 0 - 0.9$  m, uncheck the box for **Velocity (X)** and check the box for **Shear Stress**. Rename the xy-plot to **Local Friction Coefficient for Laminar and Turbulent Boundary Layer**. An Excel file will open with figure 2.32. Figure 2.32 is showing the Flow Simulation is able to capture the local friction coefficient in the laminar region in the Reynolds number range 10,000 – 200,000. At  $Re = 200,000$  there is an abrupt increase in the friction coefficient caused by laminar to turbulent transition. In the turbulent region the friction coefficient is decreasing again but the local friction coefficient from Flow Simulation is significantly lower than empirical data.

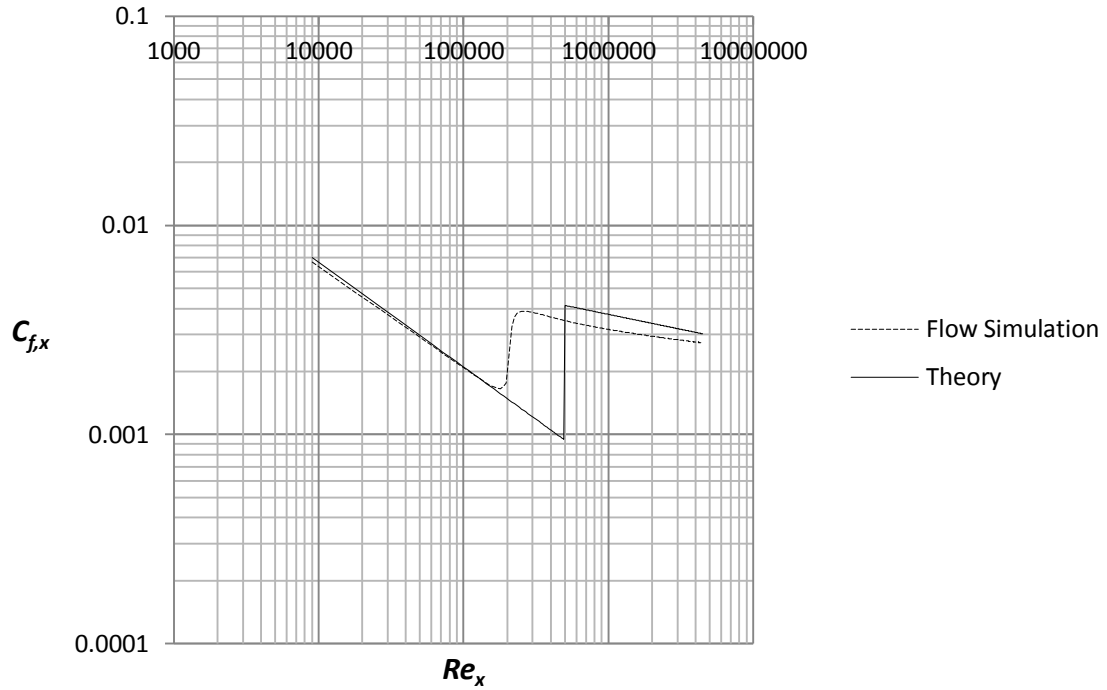

Figure 2.32 A comparison between Flow Simulation (dashed line) and theoretical laminar and empirical turbulent friction coefficients

The average friction coefficient over the whole plate  $C_f$  is a function of the surface roughness for the turbulent boundary layer and also a function of the Reynolds number based on the length of the plate  $Re_L$ , see figure E3 in Exercise 8. This friction coefficient can be determined in Flow Simulation by using the final value of the global goal, the X-component of the Shear Force  $F_f$  and dividing it by the dynamic pressure times the area  $A$  in the X-Z plane of the computational domain related to the flat plate, see figure 2.28a) for the size of the computational domain.

$$C_f = \frac{F_f}{\frac{1}{2}\rho U^2 A} = \frac{0.1485N}{\frac{1}{2} \cdot 998kg/m^3 \cdot 5^2 m^2/s^2 \cdot 1m \cdot 0.004m} = 0.00298 \quad (2.21)$$

$$Re_L = \frac{UL}{\nu} = \frac{5m/s \cdot 1m}{1.004 \cdot 10^{-6} m^2/s} = 4.98 \cdot 10^6 \quad (2.22)$$

The variation and final values of the goal can be found in the solver window during or after calculation by clicking on the associated flag, see figures 2.33 and 2.29d).

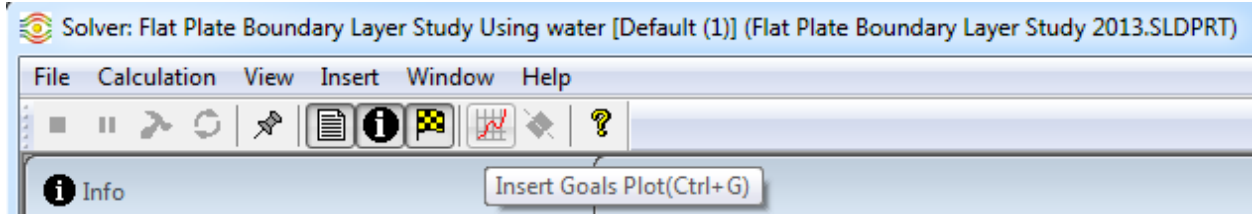

Figure 2.33 Obtaining the current value of the global goal

For comparison with Flow Simulation results we use equation (19) with  $Re_{cr} = 200,000$

$$C_f = \frac{0.0315}{Re_L^{1/7}} - \frac{1}{Re_L} \left( 0.0315 Re_{cr}^{6/7} - 1.328 \sqrt{Re_{cr}} \right) = 0.00338 \quad (2.23)$$

This is a difference of 12%.

## References

- [1] Çengel, Y. A., and Cimbala J.M., Fluid Mechanics Fundamentals and Applications, 1<sup>st</sup> Edition, McGraw-Hill, 2006.
- [2] Fransson, J. H. M., Leading Edge Design Process Using a Commercial Flow Solver, Experiments in Fluids 37, 929 – 932, 2004.
- [3] Schlichting, H., and Gersten, K., Boundary Layer Theory, 8<sup>th</sup> Revised and Enlarged Edition, Springer, 2001.
- [4] SolidWorks Flow Simulation 2013 Technical Reference
- [5] White, F. M., Fluid Mechanics, 4<sup>th</sup> Edition, McGraw-Hill, 1999.

## Exercises

- 2.1 Change the number of cells per X and Y (see figure 2.16b)) for the laminar boundary layer and plot graphs of the boundary layer thickness, displacement thickness, momentum thickness and local friction coefficient versus Reynolds number for different combinations of cells per X and Y. Compare with theoretical results.
- 2.2 Choose one Reynolds number and one value of number of cells per X for the laminar boundary layer and plot the variation in boundary layer thickness, displacement thickness and momentum thickness versus number of cells per Y. Compare with theoretical results.

- 2.3 Choose one Reynolds number and one value of number of cells per Y for the laminar boundary layer and plot the variation in boundary layer thickness, displacement thickness and momentum thickness versus number of cells per X. Compare with theoretical results.
- 2.4 Import the file “Leading Edge of Flat Plate”. Study the air flow around the leading edge at 5 m/s free stream velocity and determine the laminar velocity boundary layer at different locations on the upper side of the leading edge and compare with the Blasius solution. Also, compare the local friction coefficient with figure 2.26. Use different values of the initial mesh to see how it affects the results.



Figure E1. Leading edge of asymmetric flat plate, see Fransson (2004)

- 2.5 Modify the geometry of the flow region used in this chapter by changing the slope of the upper ideal wall so that it is not parallel with the lower flat plate. By doing this you get a streamwise pressure gradient in the flow. Use air at 5 m/s and compare your laminar boundary layer velocity profiles for both accelerating and decelerating free stream flow with profiles without a streamwise pressure gradient.

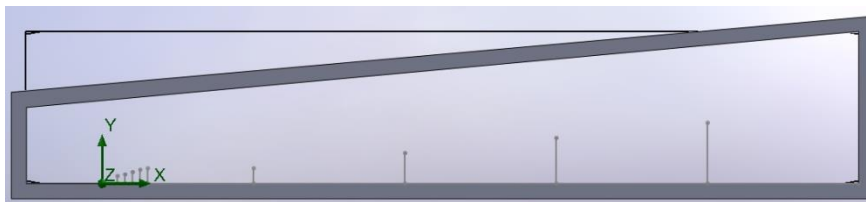

Figure E2. Example of geometry for a decelerating outer free stream flow.

- 2.6 Determine the displacement thickness, momentum thickness and shape factor for the turbulent boundary layers in figure 2.30a) and determine the percent differences as compared with empirical data.

2.7 Change the distribution of cells using different values of the ratios in the X and Y directions, see figure 2.28b), for the turbulent boundary layer and plot graphs of the boundary layer thickness, displacement thickness, momentum thickness and local friction coefficient versus Reynolds number for different combinations of ratios. Compare with theoretical results.

2.8 Use different fluids, surface roughness, free stream velocities and length of the computational domain to compare the average friction coefficient over the entire flat plate with figure E3.

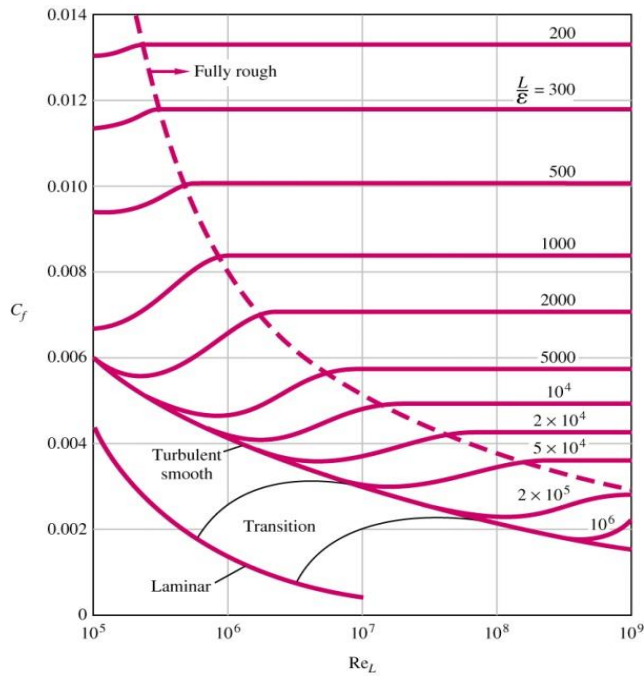

Figure E3 Average friction coefficient for flow over smooth and rough flat plates, White (1999)

Notes: