

Residential Design Using AutoCAD® 2015

Includes video instruction

Daniel John Stine CSI, CDT



SDC
PUBLICATIONS

Better Textbooks. Lower Prices.
www.SDCpublications.com

Visit the following websites to learn more about this book:



[amazon.com](https://www.amazon.com)

[Google books](https://books.google.com)

[BARNES & NOBLE](https://www.barnesandnoble.com)

Lesson 2

Crash Course Introduction (the Basics):

This lesson is meant to give you a brief introduction to a few of the most used commands. You will be walked through each drawing in this lesson, step-by-step. The intent is for the user to get some of the basic concepts in mind before going through subsequent chapters.

Exercise 2-1:

Lines and Shapes

Drawing Lines:

The number one command in AutoCAD is the **Line** command. Lines in AutoCAD are extremely precise drawing elements. This means you can create very accurate drawings. Lines, or any drawn object, can be as precise as eight decimal places (i.e., 24.99999999) or $1/256$.

AutoCAD is a vector based program. That means each drawn object is stored in a numerical database. For example, a line is stored in the drawing's database as the X,Y, Z coordinates for its starting point and the X,Y,Z, coordinates for its endpoint. These coordinates are all relative to the drawing's 0,0,0 position, called the **Origin**.

When a line needs to be displayed on the screen, AutoCAD reads the line's coordinates from the drawing database and displays a line between those two points on the screen. This means that the line will be very accurate at any scale or zoom magnification.

A raster based program, in contrast to vector based, is comprised of dots that infill a grid. The grid can vary in density, and is typically referred to by its resolution (e.g., 600x800, 1600x1200, etc.). This file type is used by graphics programs that typically deal with photographs, such as Adobe Photoshop. There are two reasons this type of file is not appropriate for CAD programs:

1. A raster based line is composed of many dots on a grid (which also represents the line's width). When you zoom in (or magnify) the line, it becomes pixilated and you actually start to see each dot in the grid. In a vector file you can "infinitely" zoom in on a line and it will never become pixilated because the program recalculates the line each time you zoom in.
2. A CAD program, such as AutoCAD, only needs to store the starting point and end point coordinates for each line; the dots needed to draw the line are calculated on the fly for the current screen resolution. Whereas a raster file has to store each dot that represents the full length and width of the line. This can vary from a few hundred dots to several thousand dots, depending on the resolution, for the same line.

The following graphic illustrates this point:

Vector vs. Raster lines

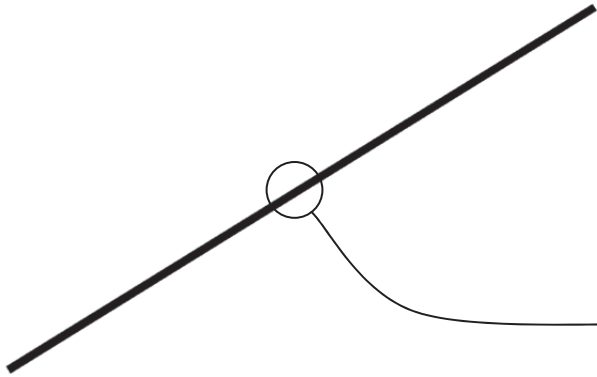

FIGURE 2-1.1 Vector Line Example
File Size: approx. 33kb

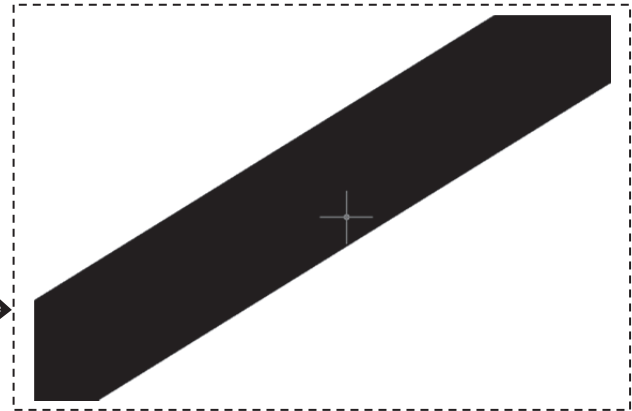

FIGURE 2-1.1A Vector Line Enlarged 1600%

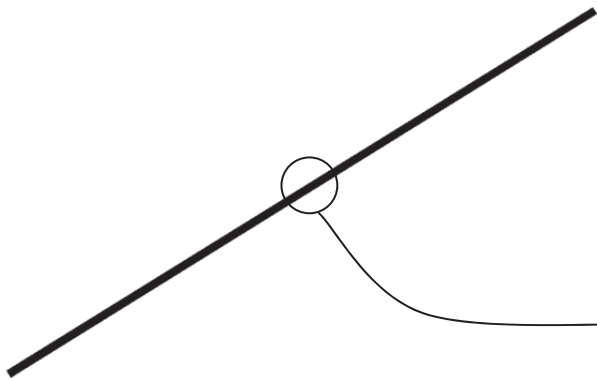

FIGURE 2-1.2 Raster Line Example
File Size: approx. 4.4MB

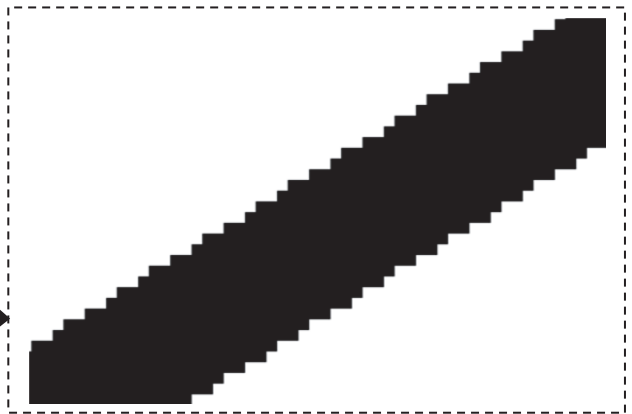

FIGURE 2-1.2A Raster Line Enlarged 1600%

The Line Command:

You will now study the **Line** command.

3. **Open** AutoCAD; maximize the application window so it fills the screen.
4. Click the down-arrow next to the word **Templates** (see image to right).

WARNING: The default startup drawing that is opened by clicking directly in the 'Start Drawing' area does not have the various variables preset for architectural CAD use. Once you select a different template, in the next step, it will become the default; this only applies to the computer you are on.

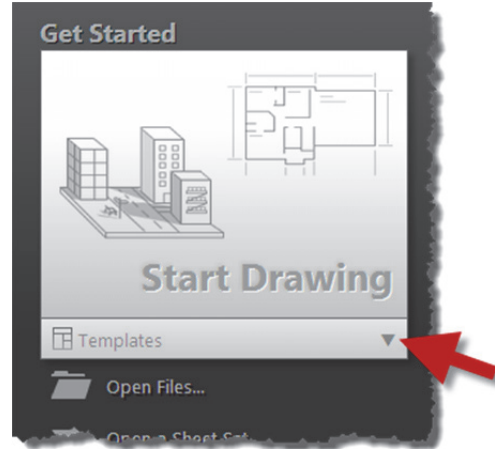

5. Under the SheetSets heading, select **Architectural Imperial.dwt**.
6. Skip this step.
7. Click on the **Model** tab to switch to *Model Space* (which is where all the drawing is done as previously mentioned); see Figure 2-1.3.
 - a. Turn off the *Grid Display* toggle if it is on (via the *Status Bar*).

NOTE: Your Drawing Window background should be black – the images in the book have it set to white for clarity in printing.



FIGURE 2-1.3 Switching to Model space

8. Select the **Line** tool (*Home* tab, *Draw* panel). 

Line
9. **Draw a line** from the lower left corner of the screen to the upper right corner of the screen (by simply clicking two points on the screen); see **Figure 2-1.4**.

TIP: When clicking the second point, do not click on, or over, the *ViewCube* in the upper right. See Figure 1-2.1.

NOTE: Do not drag/hold your mouse button down; just click.

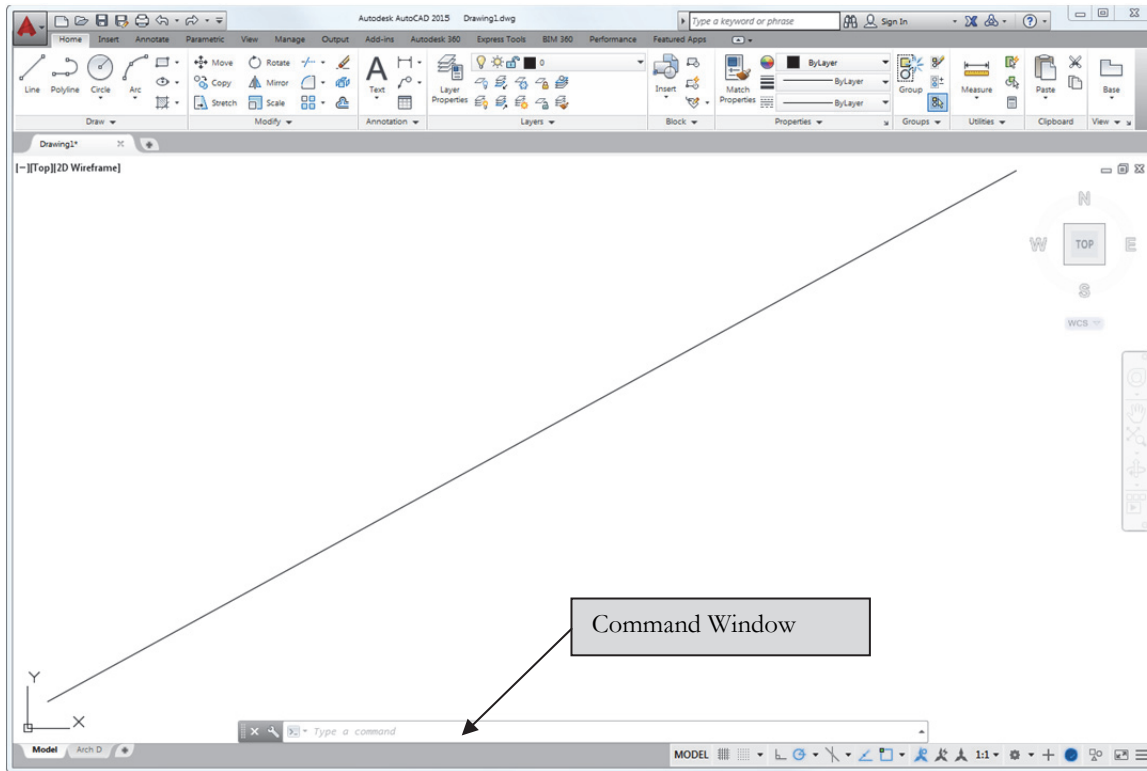

FIGURE 2-1.4 Your first line!

After clicking your second point, you should notice by looking at the *Command Window*, that the **Line** command is still active. You could continue to draw lines, with the last point picked becoming the first point for the next line segment. In this case you will end the **Line** command per the following instructions.

10. After clicking your second point (i.e., the endpoint), **right-click** anywhere on the screen and select **Enter** from the pop-up menu (Figure 2-1.5).

This constitutes your first line! However, as you are probably aware, it is not a very accurate line as far as length and angle are concerned.

***FYI:** Your line length and proportions may vary slightly from the image above and the following few steps based on your screen size and resolution. This will not negatively affect your ability to complete this section. In any case, you should maximize the AutoCAD program so you see the largest drawing window possible.*

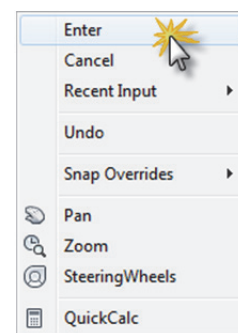

FIGURE 2-1.5 Right-click Menu; Line command active

The Properties Palette:

Typically you need to provide information such as length and angle when drawing a line; you rarely pick arbitrary points on the screen like you did in the previous steps. Most of the time you also need to accurately pick your starting point (for example, how far one line is from another or picking the exact middle point on another line).

DID YOU MAKE A MISTAKE?



LOCATION: *QUICK ACCESS TOOLBAR*

Whenever you make a mistake in AutoCAD you can use the **UNDO** command to revert to a previous drawing state. You can perform multiple UNDOs all the way to your previous *Save* (and then some).

Similarly, if you press **Undo** a few too many times, you can use **REDO**

Having said that, however, the line you just drew still has precise numbers associated with its length and angle. In the next step you will use the *Properties* palette to view the line's length and angle.

11. Select the **Properties** icon (**View** tab, *Palettes* panel) or press Ctrl + 1.



Properties

You now have the *Properties* palette open on your screen. Notice that the textbox at the top says “No selection”; this is because no objects are selected yet (Figure 2-1.6).

TIP: If the Properties palette is too narrow on the screen, some information may not be completely visible. You can easily resize any palette by dragging one of the three sides (opposite the palette title bar).

Now that the *Properties* palette is open, you can select the line to display its properties.

12. **Select the Line**; hover the cursor over the line and click on it.

FYI: Notice the line highlights before you select it. This helps to select the correct line the first time.

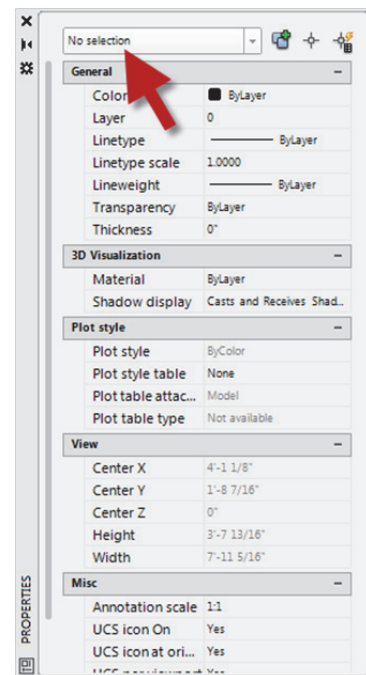

FIGURE 2-1.6 Properties Palette; No objects selected

You should now see the line's properties. Notice the textbox at the top now indicates what type of object is selected (Figure 2-1.7).

Are Your Units and Drawing Window Size Correct?

If the properties on your computer are displaying the line's data in decimals instead of feet and inches (as shown in Figure 2-1.7), that means you did not start using the correct template file.

Similarly, if your *Drawing Window* is not approximately 5'-6" x 3'-0" then you either started with the wrong template or your template file has been altered; if the latter is the case, which is less likely, zoom in (or out) to "correct" the screen display for this exercise.

If you started with the wrong template you should close the drawing and start this lesson over.

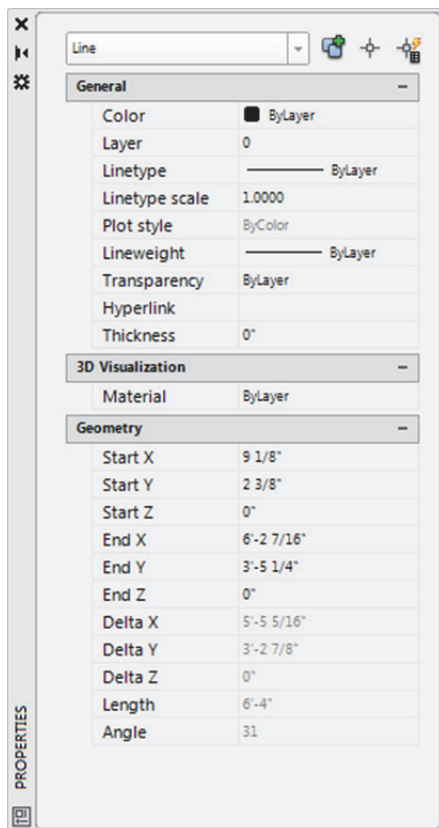

Notice the information displayed for the selected line:

- The X, Y and Z coordinates are listed, relative to the drawing's origin (0,0,0), for both the start and end points.
- The line's Length and Angle are listed.
- Delta X and Delta Y; the Delta X is the horizontal distance between the start point and the end point.

The black text are editable values and the grey text are not. You cannot edit the length, for example, because AutoCAD needs more info, like what direction to make the line longer.

FIGURE 2-1.7
Properties palette; Line selected

You should make one final observation about the line's properties and the current view: the Delta X and Delta Y represent the horizontal and vertical distances between the line's start and end points. This tells us that the drawing area, currently visible on the screen, is about 5'-5" across (horizontally) and 3'-2" up and down (vertically). That means that the largest item we can draw (and still see what we are doing) is something that is 5'-5" wide x 3'-2" tall. (See Figure 2-1.8.)

RECAP: At any given time you could draw a diagonal line, from one corner of the Drawing window to the other, list that line's Properties, observe the Delta X and Delta Y values, and infer from that information the current drawing area that you are zoomed into.

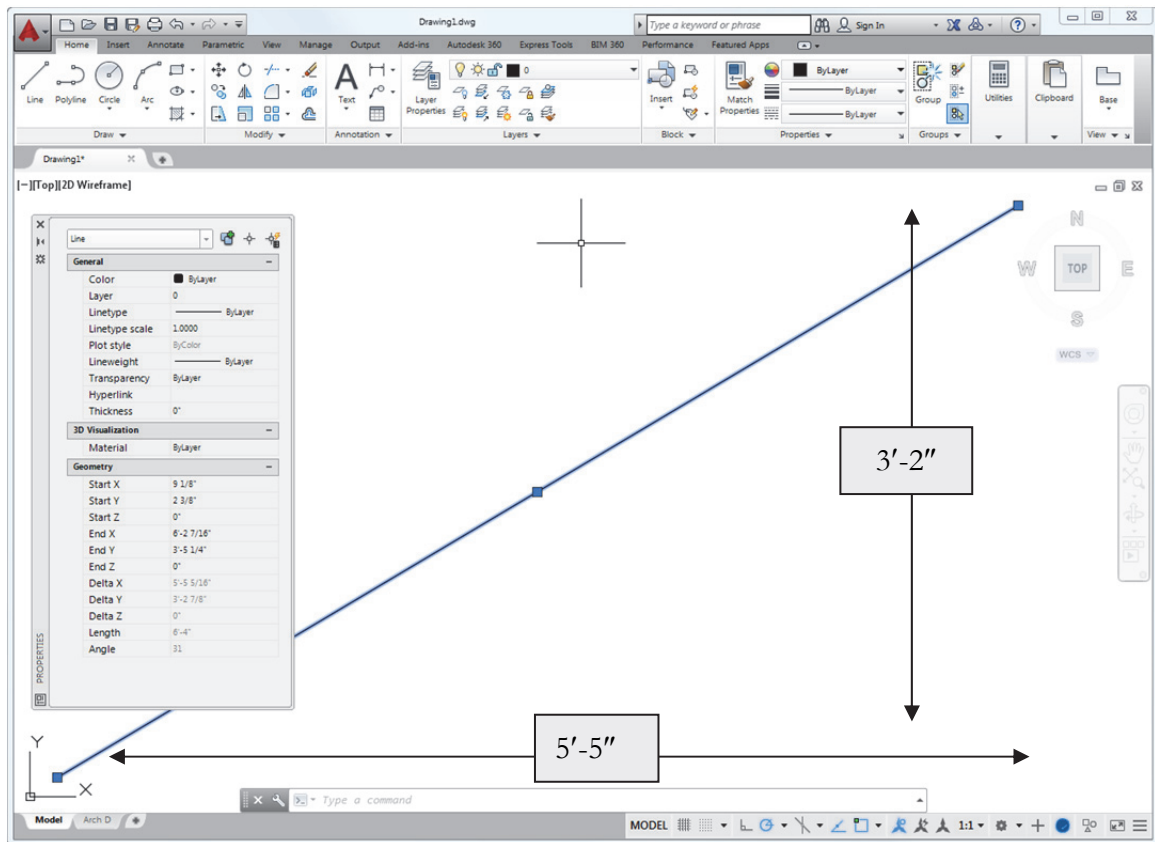

FIGURE 2-1.8 Visible area of current drawing

Everything is Drawn Full-Scale:

Even though your current view is showing a relatively small area, *Model Space* (where you do all your drafting and design) is actually an infinite drawing board.

In architectural CAD drafting, everything is drawn “real-world” size (or full-scale). ALWAYS! If you are drawing a building, you might draw a line for the exterior wall that is 600'-0" long. If you are drawing a window detail, you might draw a line that is 1/8" long. In either case you are entering that line's actual length.

You could, of course, have a 1/8" line and a 600'-0" line in the same drawing. Either line would be difficult to see at the current drawing magnification (i.e., approx. 5'-5" x 3'-2" area). So you would have to zoom in to see the 1/8" line and zoom out to see the 600'-0" line. You will try this next:

Draw a 1/8" Line:

13. For now, **Close** the *Properties* palette by clicking the **X** in the upper corner of the palette.

The next steps will walk you through drawing a 1/8" horizontal line. AutoCAD provides more than one way to do this. You will try one of them now.

You should understand that it is virtually impossible to draw a perfectly horizontal or vertical (or any precise angle) line by visually picking points on the screen. You need AutoCAD's help!

14. On the *Status Bar*, make sure **Polar Tracking** is turned on. (Figure 2-1.9). *It should have a bluish highlight when turned on.*

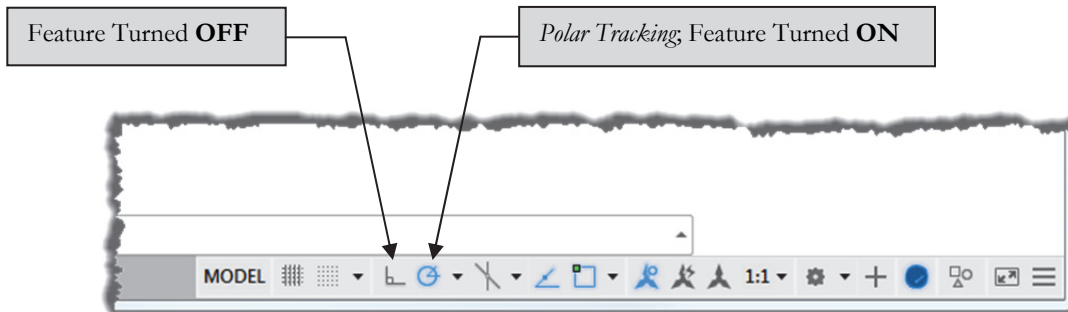

FIGURE 2-1.9 Status Bar – shown with Polar Tracking turned on.

TIP: You can adjust the Polar Tracking settings by right-clicking on the button and selecting *Tracking Settings*.

Polar Tracking:

This drawing aid feature allows you to draw lines at precise angles. When you are in the process of drawing a line, *Polar Tracking* will “snap” to certain angles in the *Drawing* window whenever your cursor comes close to that angle.

A dashed line will appear on the screen giving you a visual tip that the line is “snapped” to one of the predefined angles set within the *Polar Tracking* settings. In addition to the dashed line, the tooltip (near your cursor) displays the word *Polar* and the locked angle.

Clicking the mouse or entering a length, while the dashed line is visible, ensures the line’s proper angle.

15. Using the **Line** command, pick a point somewhere in the upper left corner of the *Drawing* window.
16. Start moving the mouse towards the right, and generally horizontal until you see a dashed reference line (extending off the screen in the direction you want to draw the line) appear on the screen as in Figure 2-1.10.

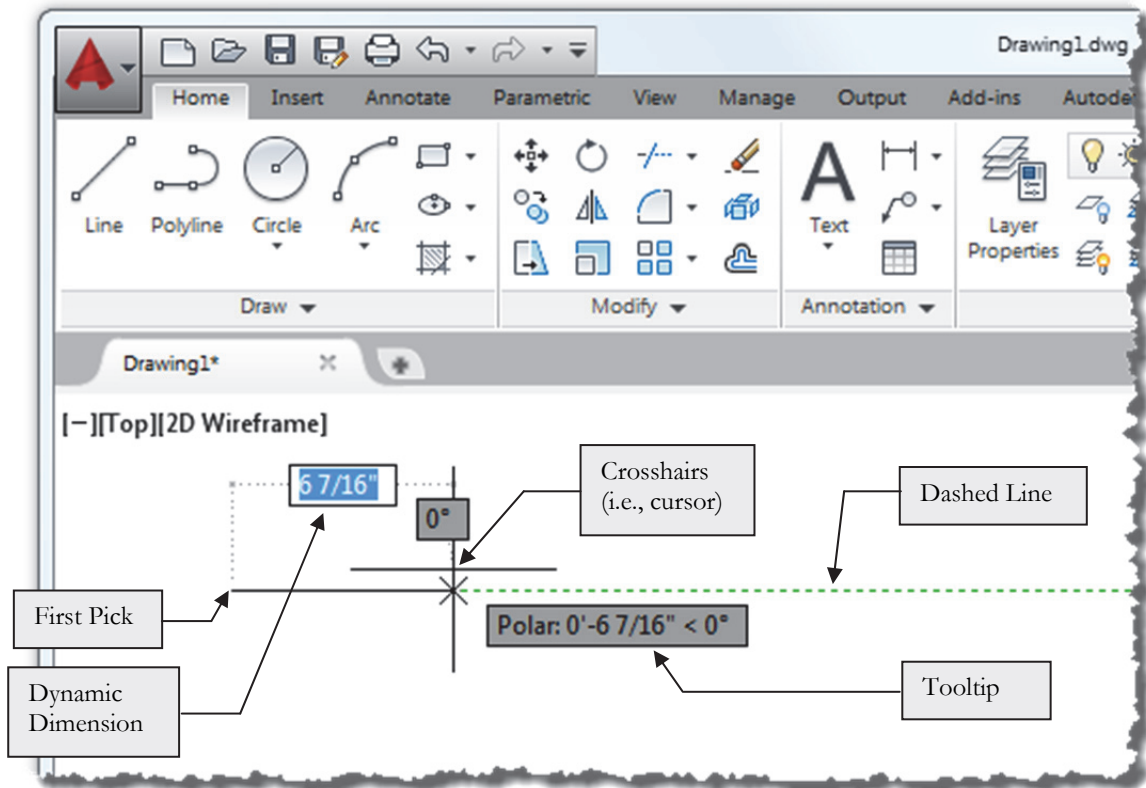

FIGURE 2-1.10 Drawing a line with the help of Polar Tracking

FYI: In order to see the on-screen dimension and the tooltip you need to make sure the **Dynamic Input** icon is toggled on; which it is by default. The toggle for this icon can be displayed on the Status Bar, but is hidden by default. Clicking the last icon on the Status Bar reveals a list where Dynamic Input can be added to the Status Bar. Please do not change this at this time.

- With the dashed line and *tooltip* visible on the screen, take your hand off the mouse (so you don't accidentally move it), type **1/8** and then press **Enter**; finish the **Line** command. **Right-click** and select **Enter** to finish the line command (you can also press the *Esc* key on the keyboard to finish).

TIP: Notice you did not have to type the inch symbol; AutoCAD always assumes you mean inches unless you specify otherwise. A future lesson will review the input options in a little more detail.

You have just drawn a line with a precise length and angle!

- Use the **Properties** palette to verify it was drawn correctly (similar to Steps 11 and 12); check the *length* and *angle* values.
- Use the **Zoom Window** tool to enlarge the view of the 1/8" line (or – better – use your wheel mouse).
- Now use the **Zoom Extents** tool so that both lines are visible again (or double-click on the wheel button).

Draw a 600' line:

- Select the **Line** icon and pick a point in the lower right corner of the *Drawing* window.

FYI: Selecting a tool cancels any active commands.

- Move the crosshairs (i.e., mouse) straight up from your first point so that *Polar Tracking* activates (Figure 2-1.11).
- With the dashed line and tooltip visible on the screen, take your hand off the mouse (so you don't accidentally move it), and type **600'** and then press **Enter**.

TIP: Notice this time you had to type the foot symbol (') or AutoCAD would have assumed you meant 600 inches, which is only 50'.

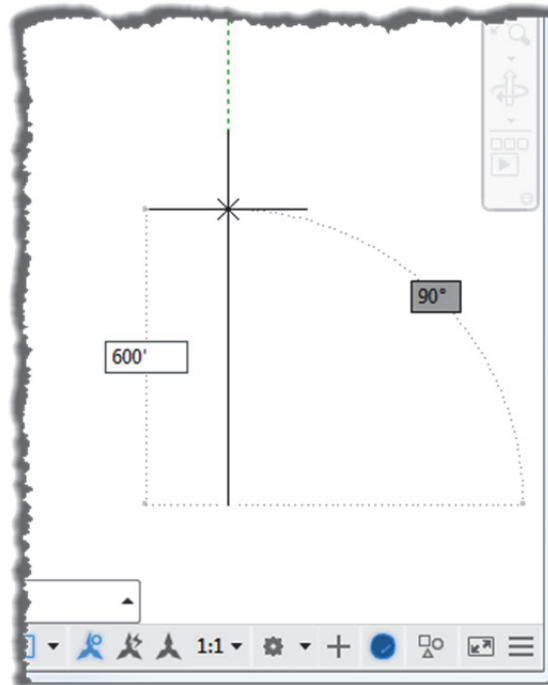

FIGURE 2-1.11 Drawing another line with the help of Polar Tracking

- End the **Line** command (*right-click and select Enter or press the Esc key*).

Because the visible portion of the drawing area is only 3'-2" tall (Figure 2-1.8), you obviously would not expect to see a 600' line. You need to change the drawing's magnification (i.e., zoom out) to see it.

25. Use **Zoom Extents** to see the entire drawing (Figure 2-1.12) – icon on *Navigation Bar* pointed out in image below (or double-click the center wheel mouse button).

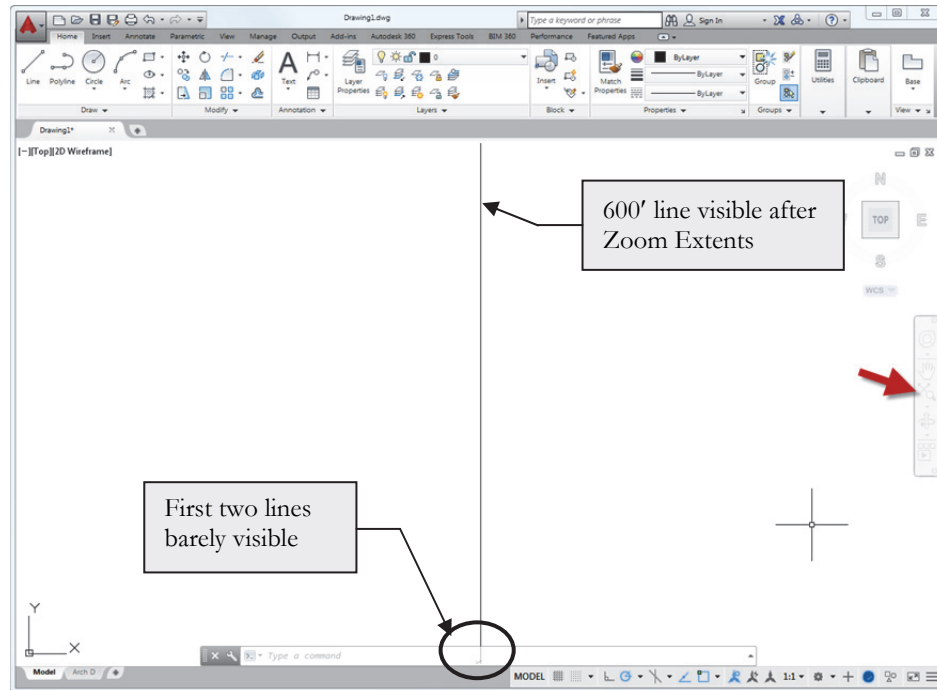
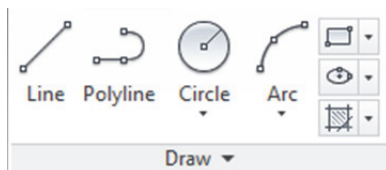

FIGURE 2-1.12 Drawing with three lines

Drawing Shapes:



AutoCAD gives you the commands to draw common shapes like square/rectangles, circles, ellipses, polygons. These commands can be found in the *Draw* panel on the *Home* tab. You will take a look at the **Rectangle** and **Circle** commands now.

SETTING YOUR WORKSPACE: *AutoCAD has several very different looking User Interfaces. So, if your screen does not look similar to the screen shots in this book, click on the small gear icon in the lower right corner of the screen and select **Drafting and Annotation** from the popup list that appears (see image to the right). Also, remember the default color theme is **Dark**, but the images used in the book are based on the **light** theme (you do not have to change this).*

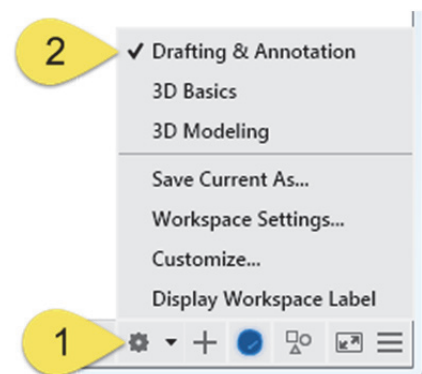

Drawing a Rectangle:

26. Use **Zoom Previous** (or **Zoom Window**) to get back to the original view.
27. Select the **Rectangle** tool from the *Draw* panel. 

Notice the *dynamic tooltip* prompt near your cursor (your values will vary slightly):

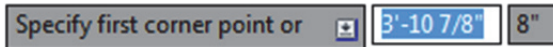

TIP: Pay attention to these prompts while you are learning AutoCAD; they tell you what information is expected/requested. Similar prompts are also displayed in the Command Window.

28. Pick your “**first corner point**” somewhere near the middle-bottom of the *Drawing* window (Figure 2-1.13).

Notice the *dynamic tooltip* prompt near your cursor has changed:

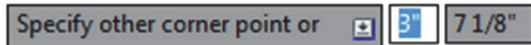

At this point you can pick a point on the screen, type an X,Y,Z coordinate, or enter the dimensions on-screen via the dynamic tooltip feature near your cursor; you will use the latter method as it is easiest (*Dynamic Input* must be toggled “on” down on the *Options Bar*). 

29. While being prompted for the “other corner”, simply start typing (AutoCAD defaults to the *Width* tooltip for dynamic input). Type **6.5** (this equals 6½”) and then press the **Tab** key on the keyboard; do not press Enter.

Pressing **Tab** toggles you over to the *Height* tooltip for dynamic input (see prompt image at the top of the next page).

Notice the *Width* just entered has a padlock symbol next to it, which means that value is locked in. So, even though you will enter a numeric value for the *Height*, you could pick a point on the screen and no matter where you picked the *Width* would be 6.5”.

TIP: When drawing a rectangle, typing negative values allows you to dictate in which direction the rectangle is drawn (relative to your first pick point). When both numbers are positive, as in the previous example, the rectangle is drawn up and to the right of your first pick point.

Notice the current on-screen prompt (second value will vary slightly):

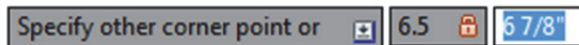

30. Type **14** and then press **Enter** (this equals 1'-2”).

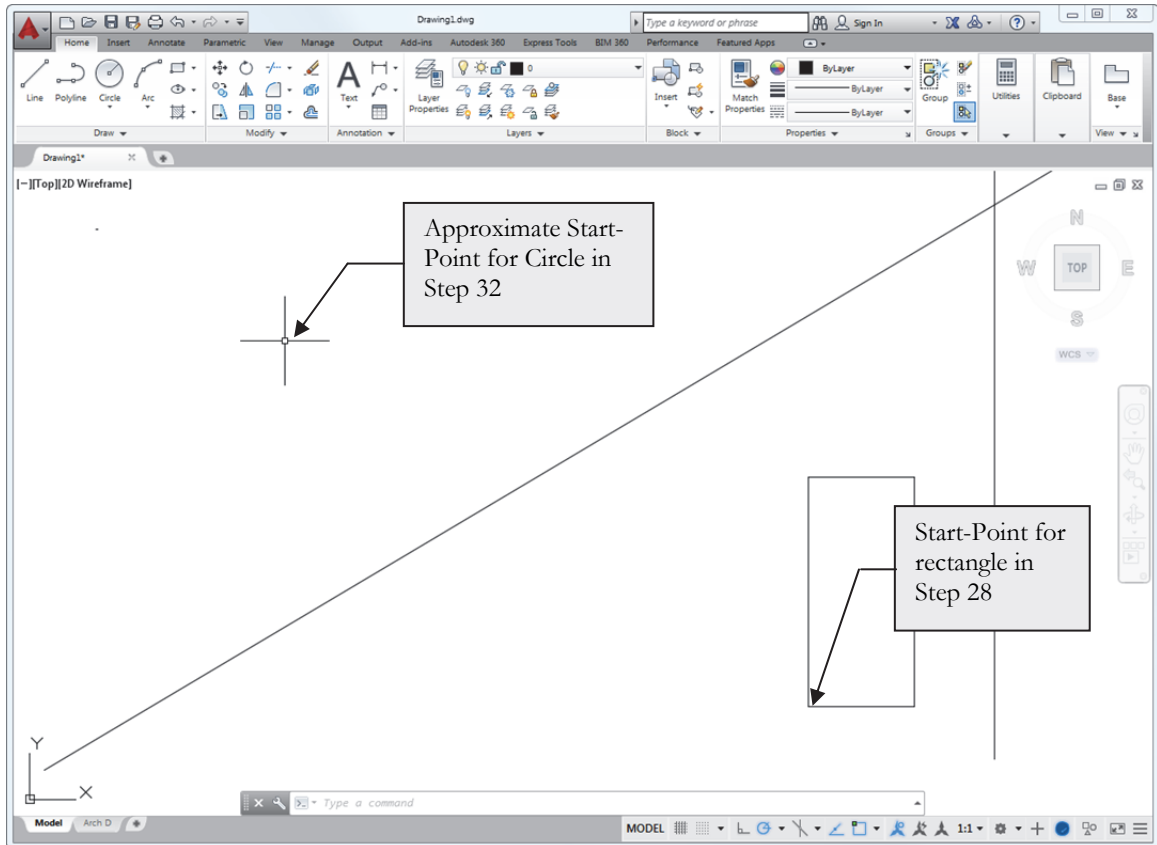

FIGURE 2-1.13 Drawing with Rectangle added

Drawing a Circle:

31. Select the **Circle** tool from the *Draw* panel; the top part of the split-button.
32. You are now prompted to pick the center point for the circle; pick a point approximately as shown in Figure 2-1.13.



You should now see the following on-screen prompt:

Specify center point for circle or

Tooltip menus:

Whenever you see a down-arrow icon within the on-screen tooltip (like the one above), you can press the down-arrow key on the keyboard to see a list of options pop up below the tooltip (see example to right). The options relate to the active command (the active command being the Circle command in this example).

Right-click menus:

Another option is to right-click the mouse to see the same options as above plus a few standard options; this is called the context menu. If you clicked Diameter, the context menu goes away and AutoCAD expects you to enter the diameter rather than the radius.

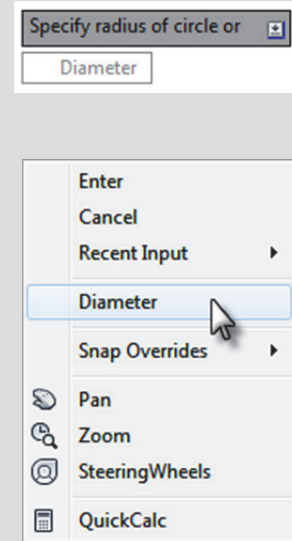

Move your mouse around to see that you could arbitrarily pick a point on the screen to create a quick circle if needed, then proceed to the next step where you will draw a circle with a radius of $6\frac{5}{8}$ ".

33. Type **6-5/8** and then press **Enter** (this equals $6\frac{5}{8}$ ").
(See Figure 2-1.15 on the next page.)
34. View the properties for both the Circle and Rectangle.

NOTE: See Figure 2-1.14 for the Circle's properties; you can actually modify the Circle by entering a new Circumference or Area.

35. **Save** your drawing as **ex2-1.dwg**. Click *Save* in the *Application Menu* and then browse to a location for your file.

TIP: If you are working on this tutorial in a school lab, you should save your files to your shared folder on the network (if you have one). In any case, be sure to backup all your files to a flash drive or cloud storage (e.g. Autodesk 360 or Dropbox).

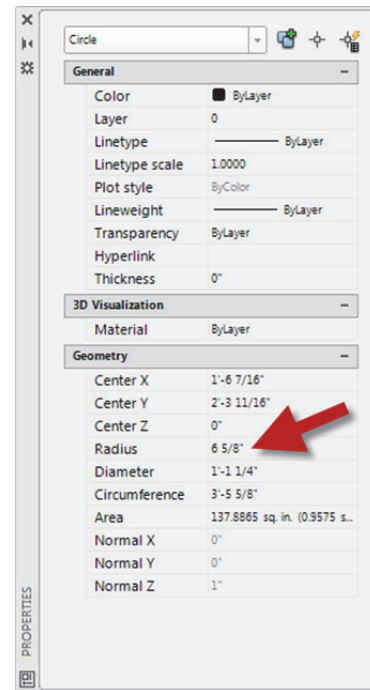

FIGURE 2-1.14 Properties for circle

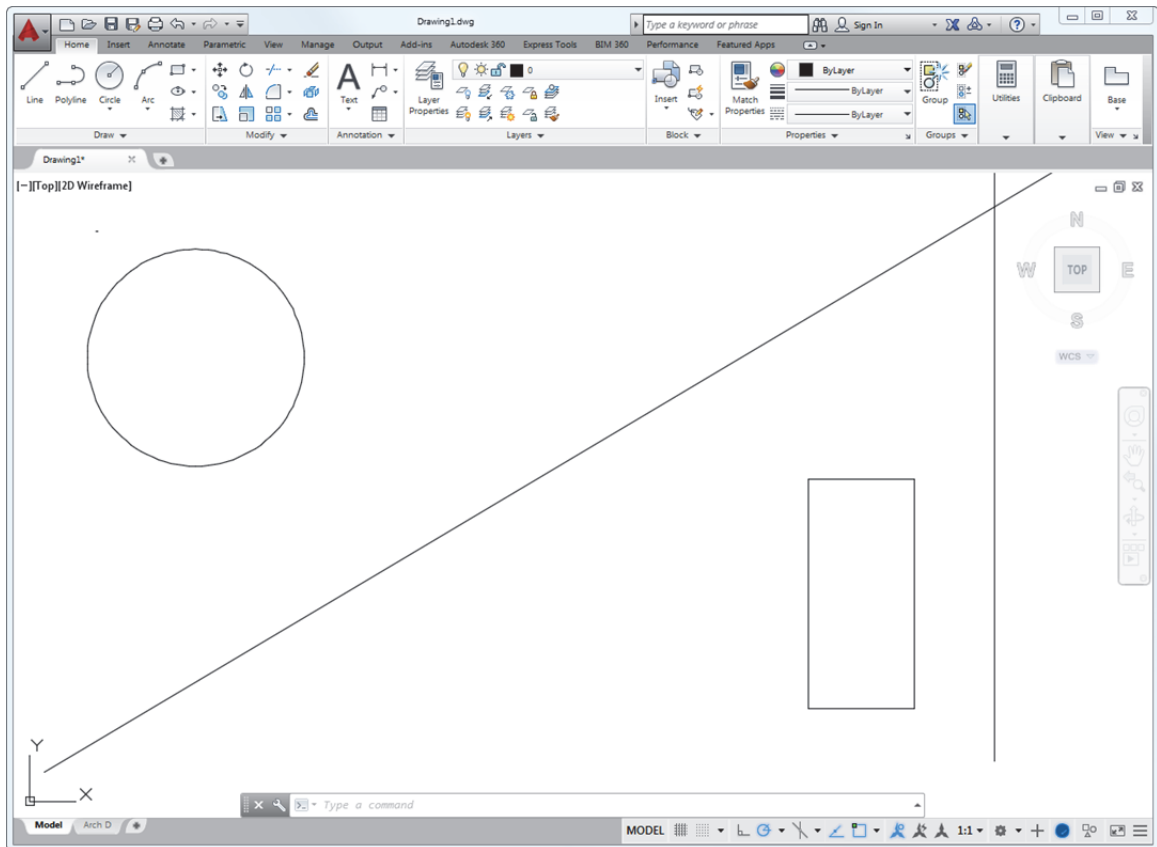

FIGURE 2-1.15 Drawing with Circle added

Where Should I Save My Files?

You should save your files to your Autodesk 360 storage space if you have set that up. Refer back to chapter one for more information on how to setup Cloud Storage.

You can also create a folder in which to save your AutoCAD files, typically a sub-folder in the My Documents folder. Your instructor may specify a location for your files if you are using this textbook in a classroom setting.

Thus far you have learned how to draw accurate orthogonal lines (i.e., horizontal and vertical) and verify their accuracy using the *Properties* palette. You can also accurately draw rectangles and circles. You have also employed *Dynamic Input* and *Polar Tracking*.

Everything drawn so far has been separate, isolated items. More often than not you will want to draw lines that connect to each other, and as previously mentioned, it is virtually impossible to simply visually pick a point on the screen and have it be perfectly accurate. So when you want to draw a new line in relation to a previously drawn one you have to use a special feature known as *Object Snaps* when drawing and modifying objects in AutoCAD. You will learn about this feature next.

Exercise 2-2: Object Snaps

Introduction

Object Snap is a tool that allows you to accurately pick a point on an object. For example, when drawing a line you can use *Object Snap* (*OSNAP*) to select as the start-point, the endpoint or midpoint of another line.

This feature is absolutely critical to drawing accurate technical drawings. Using this feature allows you to be confident you are creating perfect intersections, corners, etc. (Figure 2-2.1).

Object Snaps Options:

You can use *Object Snaps* in one of two ways:

- Using the *Running OSNAP* mode
- On an individual pick-point basis

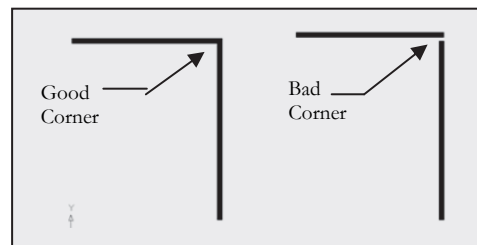

FIGURE 2-2.1 Typical problem when Object Snap is not used

Running OSNAP mode is a feature that, when turned on, constantly scans the area near your cursor when AutoCAD is looking for user input. You can configure which types of points to look for.

Using an *Object Snap* for individual pick-points allows you to quickly select a particular point on an object. This option will also override the *Running OSNAP* setting, which means you tell AutoCAD to just look for the endpoint on an object (for the next pick-point only) rather than the three or four types being scanned for by the *Running OSNAP* feature.

Enabling Running Object Snaps:

To toggle *Running Object Snap* on and off you click the **Object Snap** icon on the *Status Bar*.

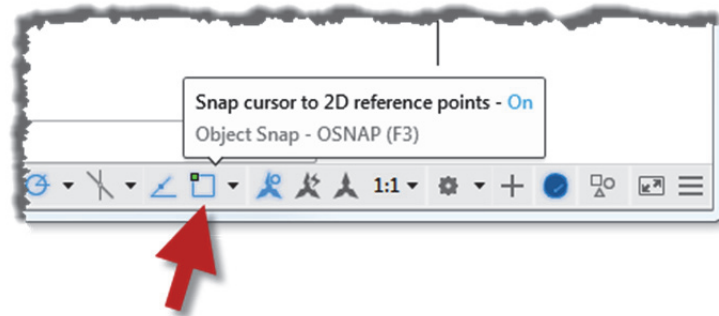

FIGURE 2-2.2 Status Bar – shown with Object Snap turned on

Snap Symbols:

When *Object Snap* is turned on, AutoCAD displays symbols as you move your cursor about the *Drawing* window (while you are in a command like **Line** and AutoCAD is awaiting your input or pick-point).

If you hold your cursor still for a moment, while a snap symbol is displayed, a tooltip will appear on the screen. However, when you become familiar with the snap symbols you can pick sooner, rather than waiting for the tooltip to display.

Symbol	Position	Keyboard Shortcut
✕	Intersection	INT
□	Endpoint	END
△	Midpoint	MID
◇	Quadrant	QUA
○	Center	CEN
⊗	Nearest	NEA
⊥	Perpendicular	PER
○	Tangent	TAN

FIGURE 2-2.3 OSNAP symbols that are displayed on the screen when selecting a point.

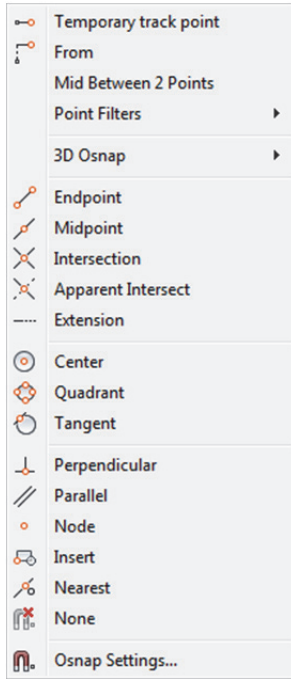

The **Tab** key cycles through the available snaps near your cursor.

The keyboard shortcut turns off the other snaps for one pick. For example, if you type *END* on the keyboard while in the **Line** command, AutoCAD will only look for an *Endpoint* for the next pick.

Finally, if you need a particular snap for just one pick, you can hold the **Shift key and right-click** for the *OSNAP* context menu (see image to left). If you pick **Center**, AutoCAD will only look for a Center to snap to for the next pick and then revert back to the previous settings.

Setting Object Snaps:

You can set AutoCAD to have just one or all *Object Snaps* running at the same time. Let's say you have *Endpoint* and *Midpoint* set to be running. While using the **Line** command, move your cursor near an existing line. When the cursor is near the end of the line, you will see the *Endpoint* symbol show up. When you move the cursor towards the middle of the line, you will see the *Midpoint* symbol show up.

The next step shows you how to tell AutoCAD which *Object Snaps* you want it to look for.

First you need to **Open** the drawing from the DVD.

1. **Open** drawing **ex2-1 Osnap.dwg** from the DVD.
 - a. You may also continue with your file from the previous exercise if you wish. However, this file is offered to make the result look more like what is seen in the book (given the random locations instructed in the previous exercise).
2. Next, do a **Save-As** and save to your hard drive; name the file **ex2-2.dwg**.

3. Click the down-arrow next to the Object Snap icon, on the *Status Bar*, and select **Object Snap Settings** from the pop-up menu (Figure 2-2.4).

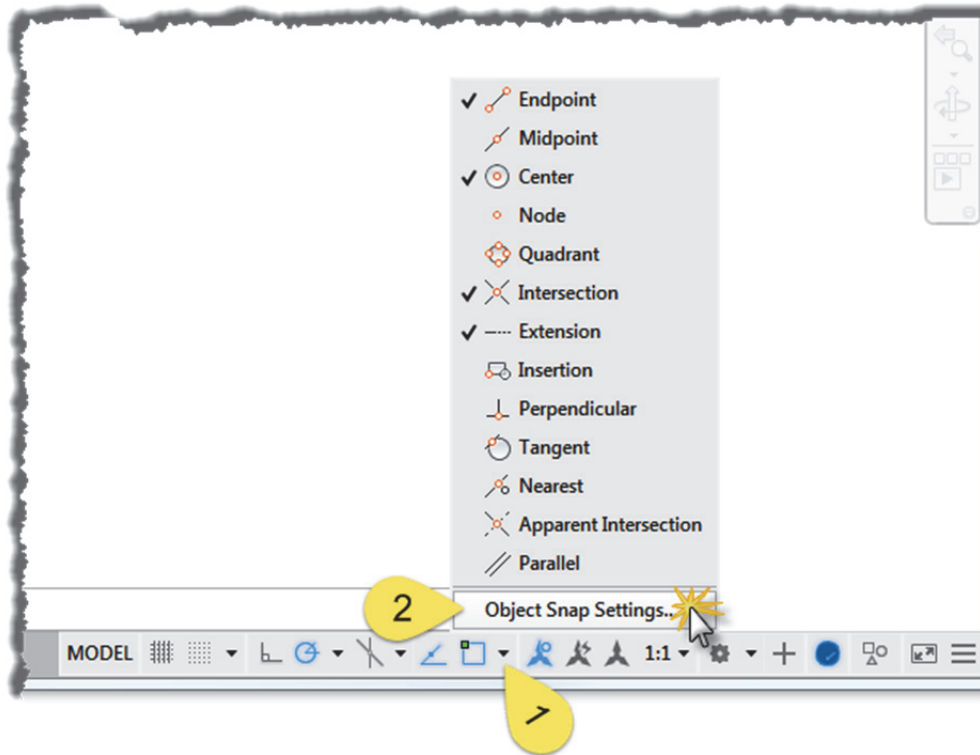

FIGURE 2-2.4 Right-click on the OSNAP button located on the *Status Bar*

You are now in the **Drafting Settings** dialog box on the *Object Snap* tab; compare to **Figure 2-2.5**.

4. Make sure only the following *Object Snaps* are checked:
 - a. Endpoint
 - b. Midpoint
 - c. Center
 - d. Intersection
 - e. Perpendicular
5. Click **OK** to close the *Drafting Settings* dialog box.

FOR MORE INFORMATION: For more on using *Object Snaps*, search AutoCAD's Help system for **Drafting Settings**. Then click the **Drafting Settings Dialog Box** and select the **Object Snap** link within the article.

FYI: The running *Object Snaps* shown in Figure 2-2.5 are for AutoCAD in general, not just the current drawing. This is convenient; you don't have to adjust to your favorite settings for each drawing (existing or new). Thus, each person working on this drawing can have their own preferences for *Object Snaps*.

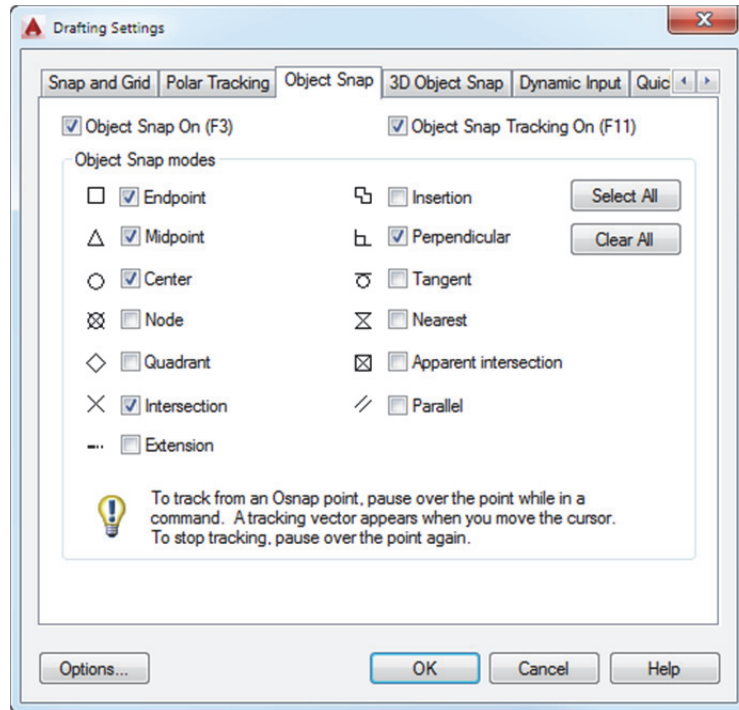

FIGURE 2-2.5 Object Snap tab on Drafting Settings dialog

Now that you have the *Running Object Snaps* set, you will give this feature a try.

6. On the *Home* tab, in the *Draw* panel, pick the **Line** command, move your cursor to the lower-left portion of the diagonal line (Figure 2-2.6).
7. Hover the cursor over the line's endpoint (without picking), when you see the *Endpoint* symbol you can click to select that point.

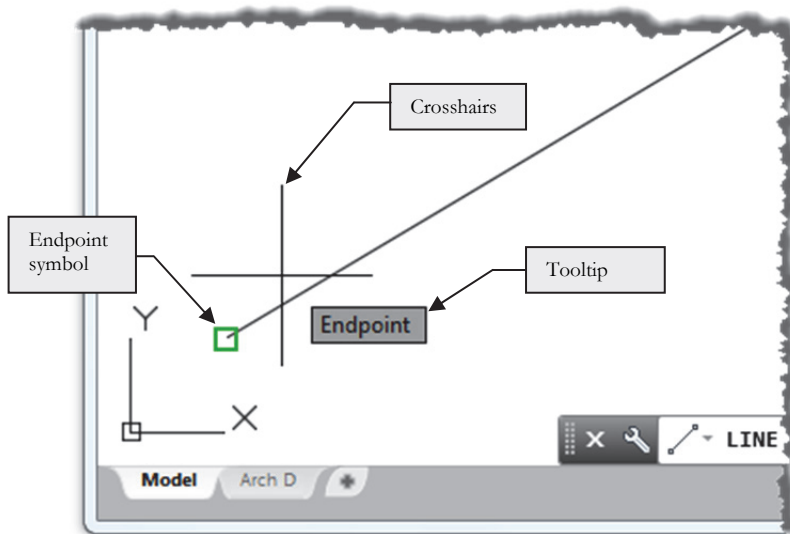

FIGURE 2-2.6 Endpoint OSNAP symbol visible

JUST SO YOU KNOW...

It is important that you see the *Object Snap* symbol before clicking. Also, once you see the symbol you should be careful not to move the mouse too much.

These steps will help to ensure accurate corners.

While still in the Line command, you will draw additional lines using *OSNAP* to accurately select the line's *start point* and *end point*.

- Draw the additional lines shown in **Figure 2-2.7** using the appropriate *Object Snap* (changing the *Running Snap* as required to select the required point).

TIP #1: When using the *Line* command you can draw several line segments without the need to terminate the *Line* command and then restart it for the next line segment. After picking the start and end points for a line, the end point automatically becomes the first point for the next line segment; this continues until you finish the *Line* command (i.e., right-click and select *Enter*).

TIP #2: At any point, while the *Line* command is active, you can right-click on the *OSNAP* button (on the *Status Bar*) and adjust its settings, or press *Shift+Right-click*; the *Line* command will not cancel.

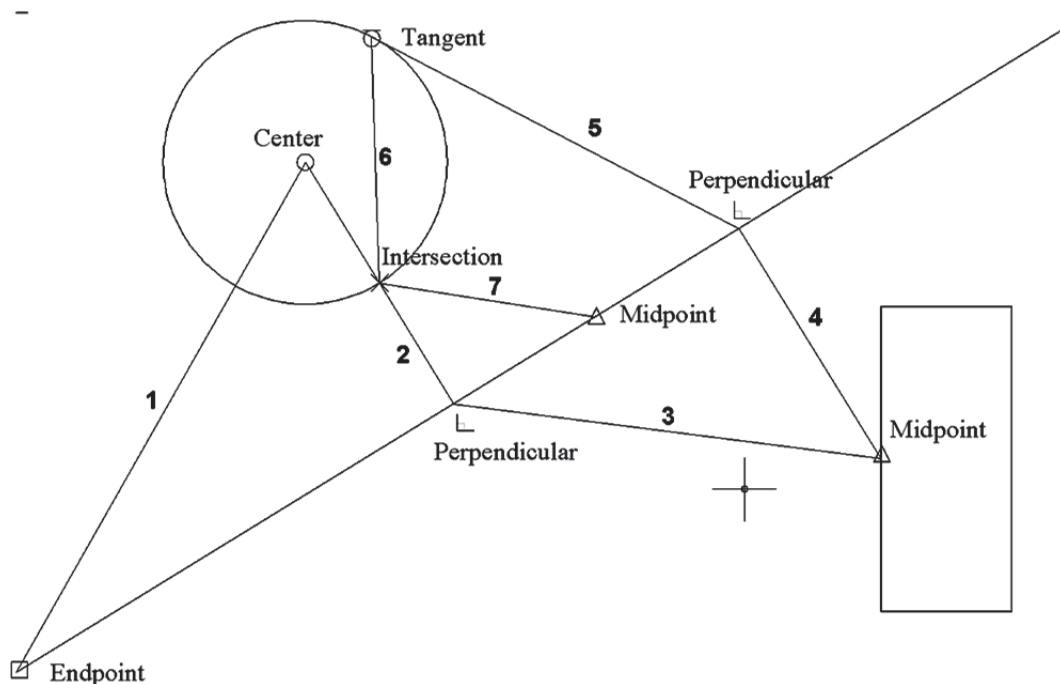

FIGURE 2-2.7 Several lines added using running OSNAPs.
The numbers indicate the order in which the lines are to be drawn.

- Save your drawing as *ex2-2.dwg*.

This is an Architectural Example?

OK, this is not really an architectural example yet. However, the point here is to focus on the fundamental concepts and not architecture just yet.

Exercise 2-3: Modify Tools

The *Modify* tools are the most used group of tools in AutoCAD. Much time is spent tweaking designs and making code related revisions.

Example: Use the *Draw tools* (e.g., Lines, Circles, Rectangles) to initially draw the walls, doors, windows and furniture. Then use the *Modify tools* to *Stretch* a room so it is larger, *Mirror* a door so it swings in the direction of egress, and *Move* the furniture per the owner's instructions.

The ability to instantly modify drawings is why CAD is so useful to architects and designers. Compared to the days of hand drawings, erasing and redrawing, CAD is a significant productivity booster.

You will access the various *Modify* tools from the *Modify* panel on the *Home* tab as introduced in Lesson 1.

This textbook focuses on the parts of a command needed to complete a specific task. If you are interested in a further investigation of a specific feature or command, you may use the *Help* system; the image below (Figure 2-3.1) shows the *Select Objects* section selected.

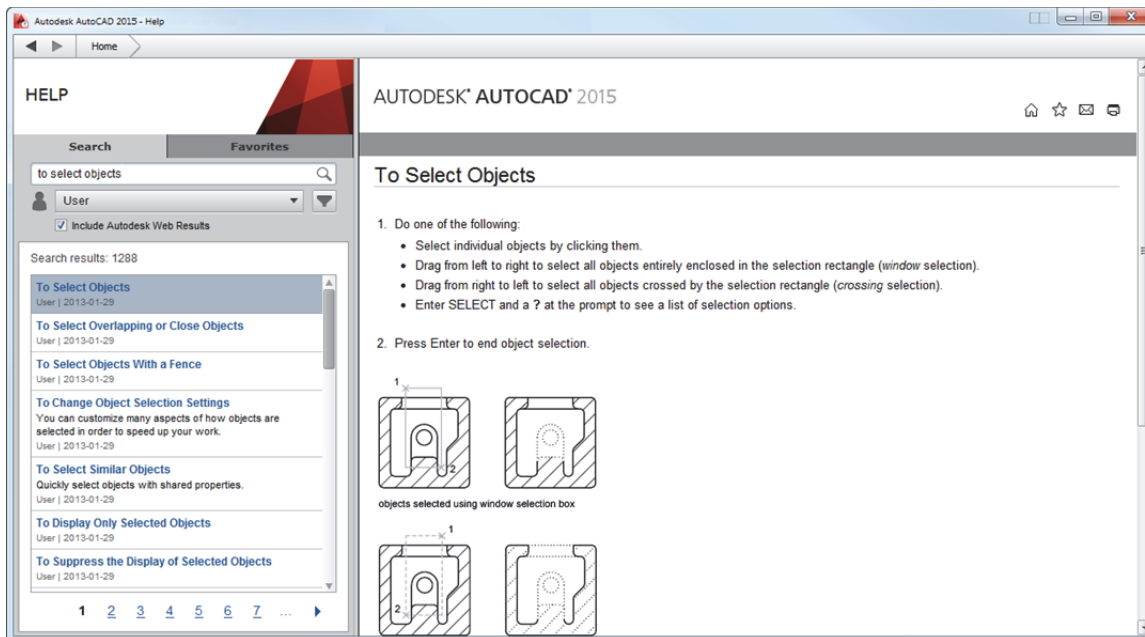

FIGURE 2-3.1 Another Help System example

In this exercise you will get a brief overview of a few of the *Modify* tools, manipulating the “tangled web” of lines you have previously drawn.

1. **Open** drawing **ex2-2.dwg** from the previous lesson.
2. **Save-As** **ex2-3.dwg**.

FYI: You will notice in this book that instructions or commands that have already been covered will have fewer “step-by-step” instructions.

Erase Command:

It is no surprise that the **Erase** tool is a necessity, things change and mistakes are made. You can erase one entity at a time or several. Erasing entities is very easy; you select the **Erase** icon, pick the objects to erase and then right-click (which equals pressing *Enter* on the keyboard). You will try this on two lines in your drawing.

3. Select **Erase** (*Modify* panel, *Home* tab).



4. [Notice the *Command* line is prompting: **Select objects:**] Use the mouse to select the lines identified in **Figure 2-3.2**.

*TIP: See the section on *Selecting Entities* on the next page.*

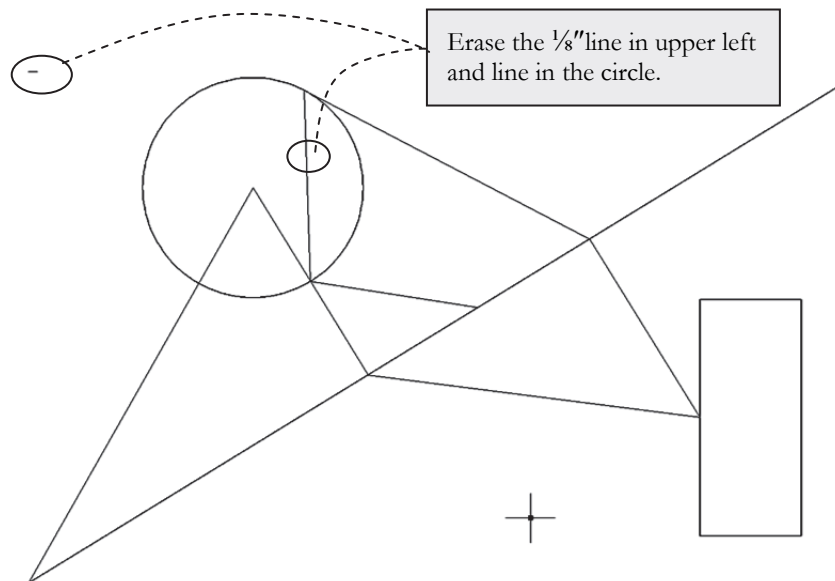

FIGURE 2-3.2 Lines to be erased

5. **Right-click** to complete the task.

Selecting Entities:

At this time we will digress and take a quick look at the various techniques for selecting entities in AutoCAD. Most commands work the same when it comes to selecting entities. As mentioned before, you need to keep your eye on the *prompts* so you know when AutoCAD is ready for you to select entities or provide other user input.

When selecting entities, you have three primary ways to select them:

- Individually select entities one at a time
- Select several entities at a time with a window
- Select several entities at a time with a lasso

You can use one, or a combination of each method to select entities (when using the Copy command for example).

Individual Selections:

When prompted to select entities (to copy or erase, for example), simply move the cursor over the object and click. With most commands you repeat this process until you have selected all the entities you need (selections are cumulative), then you typically press **Enter** or right-click to tell AutoCAD you are done selecting. Holding the *Shift* key while selecting will remove items from the current selection set. Pressing the *Esc* key (1-3 times) will unselect everything and cancel the current command.

Window Selections:

Similarly, when prompted to select entities, you can pick a Window around several entities to select them all at once. To select a window, rather than selecting an object as previously described, you select one corner of the window you wish to select (that is, you pick a point in “space”). Now as you move the mouse you will see a rectangle on the screen that represents the window you are selecting. When the window encompasses the entities you wish to select, click the mouse.

You actually have two types of windows you can select. One is called a *Window* and the other is called a *Crossing Window*.

Window:

This option allows you to select only the entities that are completely within the *Window*. Any lines that extend out of the *Window* are not selected.

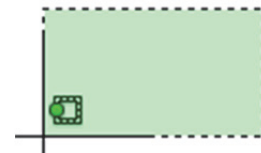

Crossing window selection

Crossing Window:

This option allows you to select all the entities that are completely within the *Window* and any that extend outside the *Window*.

Using Window versus Crossing Window:

To select a *Window* you simply pick your two points from left to right (Figure 2-3.3a).

Conversely, to select a *Crossing Window*, you pick the two diagonal points of the window from right to left (Figure 2-3.3b).

Lasso Selections:

The *Lasso* selection allows you to select an irregular area rather than a rectangular area. Simply click and hold down the mouse button to start the lasso option. You have the same *Window* and *Crossing* options as with the *Window Selection* method mentioned above.

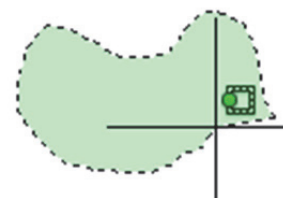

Crossing lasso selection

Below are two examples which demonstrate the difference between a Window Selection and a Crossing Window Selection.

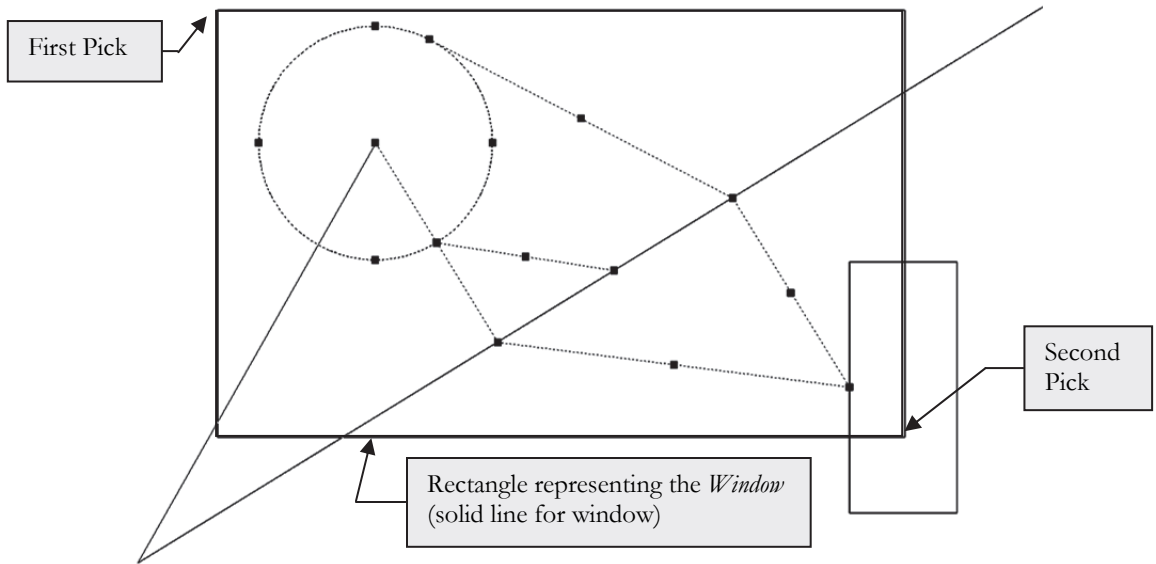

FIGURE 2-3.3A Lines selected using a *Window*; only the lines within the window are selected.

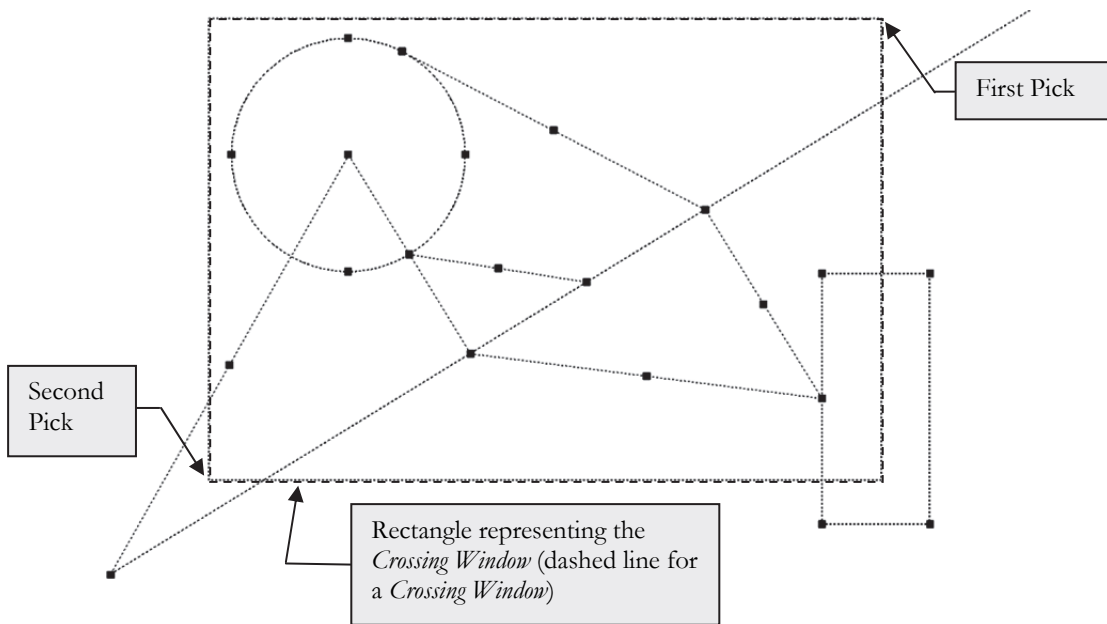

FIGURE 2-3.3B Lines selected using a *Crossing Window*; all lines are selected.

Copy Command:

The **Copy** tool allows you to accurately duplicate an entity(s). You select the items you want to copy and then pick two points that represent an imaginary vector (which provides both length and angle) defining the path used to copy the entity to; you can also type in the length and angle if there are no convenient points to pick in the drawing. You will try both methods next.

6. Select **Copy** (*Modify* panel, *Home* tab).



7. **Select the circle** and then **right-click**. *This tells AutoCAD that you are done selecting entities to copy.*

Notice the prompt:



8. Pick the **Center** of the **circle** as the base point (Figure 2-3.4).

***FYI:** You actually have three different OSNAPs you can use here: Center, Endpoint and Intersection. All occur at the exact same point.*

Notice the prompt:

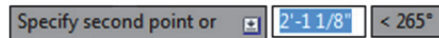

9. Pick the **Endpoint** of the angled line in the lower left corner. (See Figures 2-3.4 and 2-3.5.)

***FYI:** At this point you could continue copying the circle all over your drawing; AutoCAD will remain in copy mode until you press Esc or Enter.*

10. Press **Enter** to finish the command.

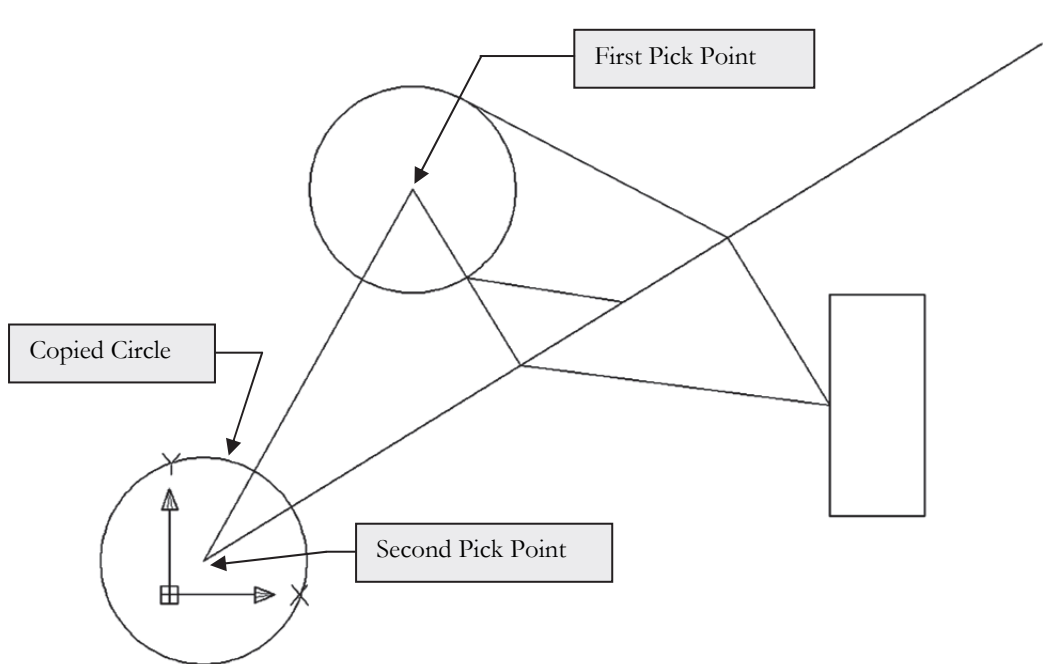

FIGURE 2-3.4 Copied circle; also indicates points selected

TIP: You may need to zoom out to see the entire circle just copied.

11. Select **Copy** again.
12. **Select the rectangle** and then **right-click**.
13. Pick an arbitrary point on the screen and then start moving your cursor up and to the right; your line cannot be “snapped” to the horizontal. *(In this scenario, it makes no difference where you pick; you will see why in a moment.)*

At this point you will type in the displacement data (i.e., distance and angle), rather than picking a second point on the screen.

14. *The following will be entered via the on-screen Dynamic Input:* Type **18**, press **Tab** then type **45** and press **Enter**. (See Figure 2-3.5 and on-screen prompts below.) Finally, press **Enter** to finish the command.

Specify second point or

Specify second point or

What does 18 Tab 45 mean?

When you need to *Move* or *Copy* something to a very specific location, you can type in the distance and angle from the original entity (i.e., use the first point as displacement). This is very useful when you do not have any entities drawn that represent this distance and angle (e.g., as per the steps when you copied the circle, Figure 2-3.4).

The **18** represents the distance, in this case 18 inches. Remember, if you do not specify feet or inches AutoCAD assumes inches. So in this example you would not have to press the extra key for the inch symbol; although 18" would work.

Here are some other valid distances:

1'4	equals	1'-4"	16	equals	1'-4"
3'	equals	3'-0"	36	equals	3'-0"
0-3/4	equals	3/4"	.75	equals	3/4"
3-5/8	equals	3 ⁵ / ₈ "	1'3-5/8"	equals	1'-3 ⁵ / ₈ "

Tab toggles over to the angle parameter (a second *Tab* gets you back to length).

The **45** represents the angle (or direction) the entities will be Moved or Copied; the angle is based off of the positive x-axis in a counter-clockwise direction.

Here are some angles and a graphical representation of their direction:

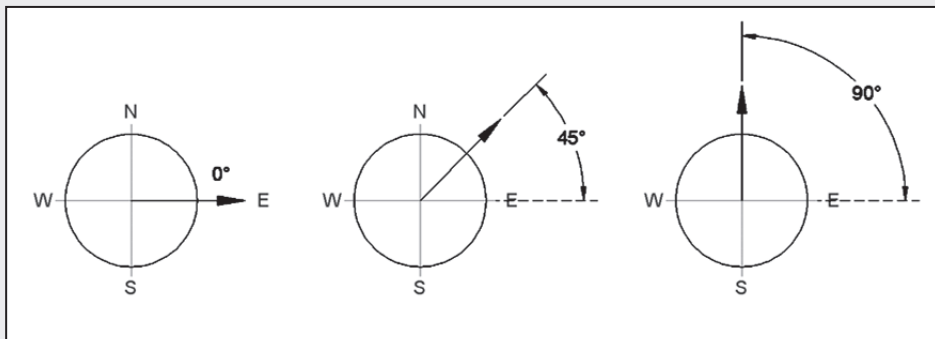

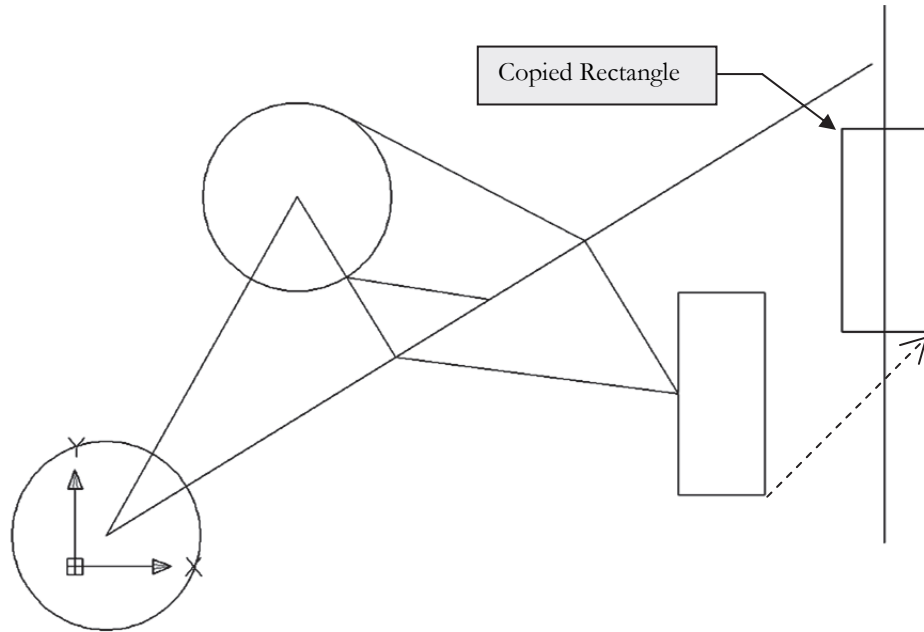

FIGURE 2-3.5 Copied rectangle. Dashed line represents the distance and angle of displacement.

***NOTE:** Your drawing may look a little different than this one because your drawing is not to scale.*

Move Command:

The **Move** command works exactly like the **Copy** command except, of course, you move the entities rather than copy them. Given the similarity to the previous command covered, the **Move** command will not be covered here. You are encouraged to try it yourself. Use the **Undo** command to get back to the drawing shown in Figure 2-3.5 before proceeding if you decide to try the **Move** command.

Rotate Command:

With the **Rotate** command, you can arbitrarily or accurately rotate one or more entities in your drawing. When you need to rotate accurately, you can pick points that define the angle (assuming points exist in the drawing to pick) or you can type a specific angle. The architectural template you are using in this book has the degrees “type” set to decimal. Other types are available such as Deg/Min/Sec and Radians, but architects typically use decimal angles unless drawing a site plan from a surveyor’s drawing that has angles listed in another format.

15. Select **Rotate** (*Modify* panel, *Home* tab).



16. **Select the rectangle** you just copied (i.e., the new one) and then **right-click**; *this tells AutoCAD that you are done selecting entities to rotate.*

You are now prompted:

Specify base point:

This is the point about which the rotation will occur.

17. Pick the *Midpoint* of the vertical line on the left side of the rectangle (Figure 2-3.6).

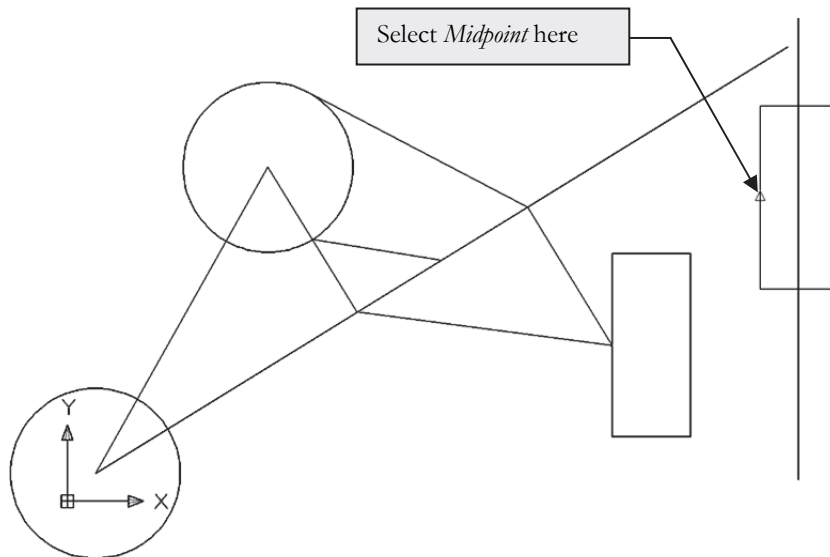



FIGURE 2-3.6 Rotate command. First Step - Select *Midpoint* of left vertical line.

You are now prompted:

Specify rotation angle or 

18. Type **90** and then press **Enter**.

Similar to the rotation angle examples recently discussed, the previous step just rotated the rectangle 90 degrees counter-clockwise (Figure 2-3.7).

19. Select the **Undo** command.



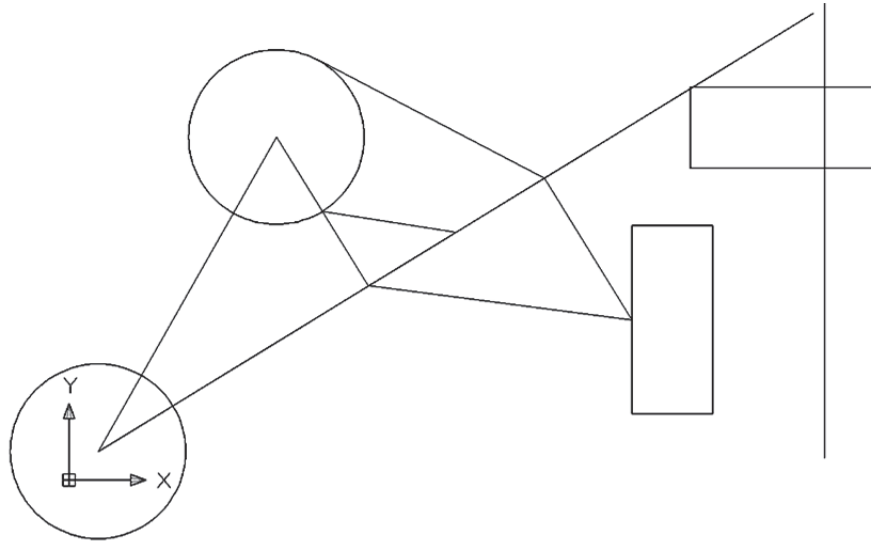

FIGURE 2-3.7 Rotate command – Rectangle rotated

Now you will do the same thing, except with a different angle. A negative angle rotates the entities in a clockwise direction.

20. After selecting *Undo* in the previous step, use the **Rotate** command, **select the rectangle** and then **pick the same *Midpoint*** as in Step 17.
21. This time, for the *Rotation Angle*, type **-45** and **Enter**.

Notice, now, that the rectangle rotated 45 degrees in the clockwise direction (Figure 2-3.8).

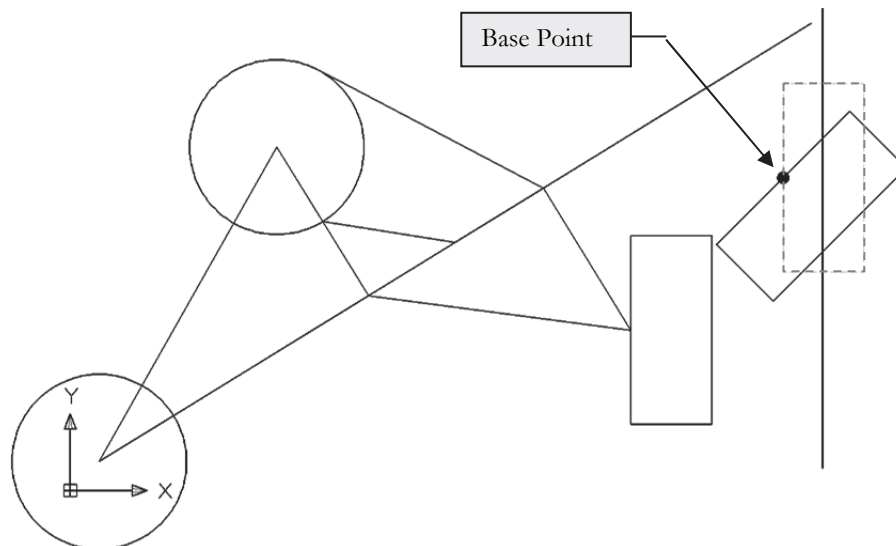

FIGURE 2-3.8 Rectangle rotated. Dashed rectangle represents original position.

Scale Command:

The **Scale** command has steps similar to the **Rotate** command. First, select what you want to scale and then specify the base point. Then, instead of entering a rotation angle, enter a scale factor (e.g., 2 or .5; where 2 would be twice the original size and .5 would be half the original size).

Next you will use the **Scale** command to adjust the size of the circle near the bottom.

Before you scale the circle, you should use the **Properties** dialog box to note the **radius** of the circle. After scaling the circle, you will refer back to the **Properties** palette to note the change. This step is meant to teach you how to verify the accuracy and dimensions of entities in AutoCAD.

TIP: You can double-click on most objects to view their quick properties.

22. Select **Scale** (*Modify* panel, *Home* tab).

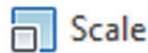

23. **Select the circle** (the one at the bottom) and then **right-click**. (*Again, this tells AutoCAD you are done selecting items to scale.*)

You are now prompted:

Specify base point:

TIP: The numbers shown in the prompt above are X and Y values from the Origin; you will pick a point, not type values.

The *Base Point* is the point about which the entity (or entities) will be scaled; see the examples on the next page.

24. Pick the center of the circle. (*In this case you can use one of three OSNAPs: Center, Endpoint or Intersection.*)

You are now prompted:

Specify scale factor or 

25. Type **.5** (as shown in previous prompt) and press **Enter**.

Now use the **Properties** palette to note the change in the size of the circle, from $6\frac{5}{8}$ " to $3\frac{5}{16}$ " radius. A *Scale Factor* of .5 reduces the entities to half their original scale (Figure 2-3.9).

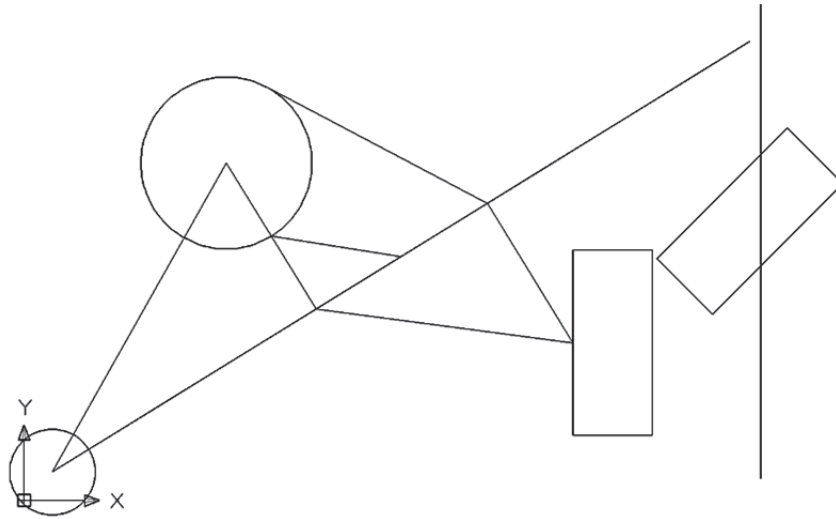

FIGURE 2-3.9 Scaled circle. Notice it is half the size of the other circle.

Selecting the Correct Base Point:

To get the desired results, you need to select the appropriate base point, for both the *Scale* and *Rotate* commands. A few examples are shown in Figure 2-3.10. The dashed line indicates the original position of the entity being modified. The black dot indicates the base point selected.

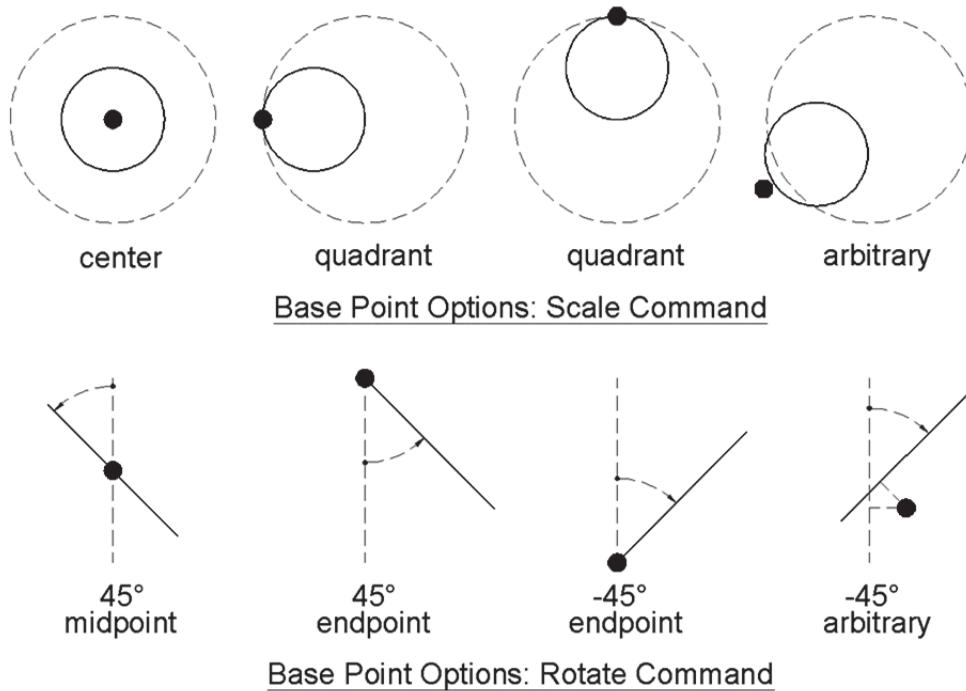

FIGURE 2-3.10 Base Point Options. The various results when different base points are selected.

This will conclude the brief tour of the *Modify* panel.

As you surely noticed, the *Modify* panel has a few other icons that have not been investigated yet. Most of these will be covered later in this book.

26. **Save** your drawing. (Your drawing should already be named: **ex2-3.dwg** per step number 2 of this exercise.)



Carter Residence

*Images courtesy of LHB
www.LHBcorp.com*

Exercise 2-4: Annotations

Annotations (text; notes) allow designers and drafters to accurately describe the drawing. You will take a quick look at this feature now.

Annotations:

Adding annotations to a drawing can be as essential as the drawing itself. Often the notes (i.e., annotations) describe something about a part of the drawing that would be difficult to discern from the drawing alone.

For example, a wall section drawing showing a bolt may not indicate, graphically, how many bolts are needed or at what spacing (because the spacing of the bolts is perpendicular to the view). The note might say “ $5/8$ ” anchor bolt at 24” O.C.” (O.C. = on center)

Next you will add text to your drawing.

1. **Open** drawing **ex2-3.dwg** from the previous lesson.
2. **Save-As** **ex2-4.dwg**.
3. **Zoom** out, if required; your screen should look like Figure 2-4.2.
4. Select the **Multiline Text** - referred to as **Mtext** (*Annotation* panel, *Home* tab). Click *OK* to any prompts about selecting an *Annotation Scale*.
 - a. Just click the top part of the split button to start the **Multiline Text** command.



Notice the current *Command* prompt; you are prompted to “**Specify first corner**”. Basically you are specifying a window (or box) that will contain the text, which is easily adjusted later as well (Figure 2-4.1).



FIGURE 2-4.1 Command prompt for Mtext command

- Pick your first point and then your second point to define a box as shown in **Figure 2-4.2**.

TIP: You rarely click and drag your mouse button in AutoCAD; mostly you click and release the mouse button, position the cursor at the second location, and then click again.

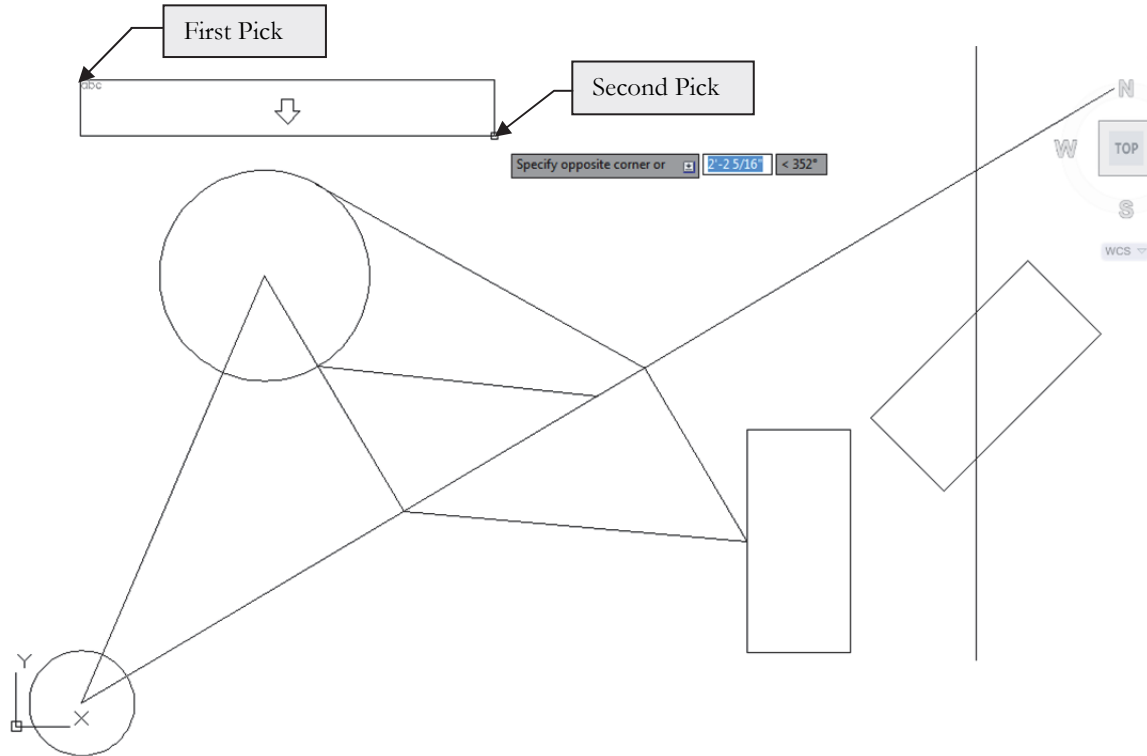
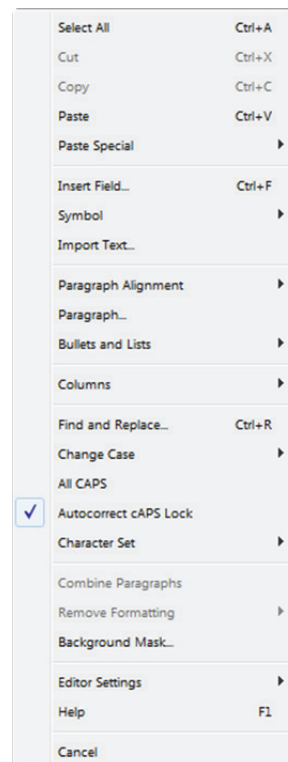

FIGURE 2-4.2 Mtext; defining the window that contains the text (first point picked; picking second)

When picking the *Mtext* window, the width is all that really matters. The width of the selected window is what controls the text wrapping feature. AutoCAD will never hide text; so as you type, if the line of text becomes longer than the width of the *Mtext* window you specified, the text will return to the next line (just like a word processor). AutoCAD will create as many lines as are required to show all the text you typed, regardless of the initial height of the *Mtext* window.

TIP: In the Mtext editor you can right-click to see a pop-up menu that gives you access to several tools like Select All, Change Case (which is an easy way to make previously typed text all upper case) and Find and Replace. See image to the right for an example.



You can now enter text in the *Mtext* window. This window will not be visible when you are done typing. The *Mtext* tool is similar to text editors like MS Word or WordPerfect; you can make text bold, italic, centered, underlined, etc.

Next you will enter some text.

6. In the *Mtext Editor* you will type the following text (Figure 2-4.3):
 - a. Set the height to **1"**. (You will have to type it in.)
 - b. Set the *Columns* option to **No Columns**.
 - c. Type: **Learning AutoCAD is fun!**

FYI: Do not add the second line (i.e., your name) yet.

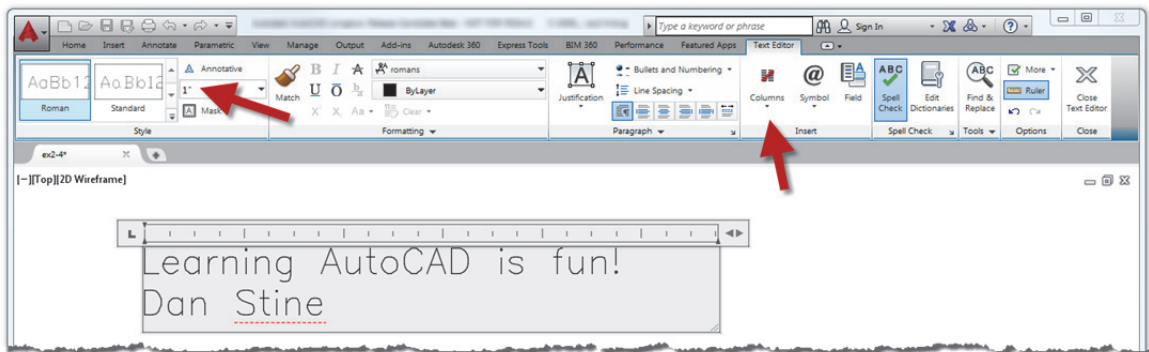

FIGURE 2-4.3 Mtext; text typed in text editor window; Text Formatting ribbon displayed

7. When finished typing text, click the **Close Text Editor** button on the *Ribbon* shown in Figure 2-4.3 above; notice the *Ribbon* changes while in text edit mode.

TIP: If you ever want to cancel the Text Editor window without typing text, you can simply press the Escape (Esc) key on the keyboard.

Your text should look similar to Figure 2-4.4. Text can be Moved and Rotated with the tools on the *Modify* toolbar.

TIP: Whenever you select an Mtext object, AutoCAD displays a grip in each corner to represent the Mtext window. A grip can be moved to increase or decrease the width of the window. The height will automatically adjust accordingly. Try it.



Whenever you want to edit text, you double-click on it.

8. Double-click on the text, position the cursor at the end of the sentence, press **Enter** (to start a new line) and then type *your* name (not the author's).

FYI: Pressing Enter within the text editor should only be done when you want to insert a “hard return”; which will ensure the following text always starts on a new line. Otherwise, changing the text box size will adjust the length of each line; this is called a “soft return”.

9. **Save** your drawing.

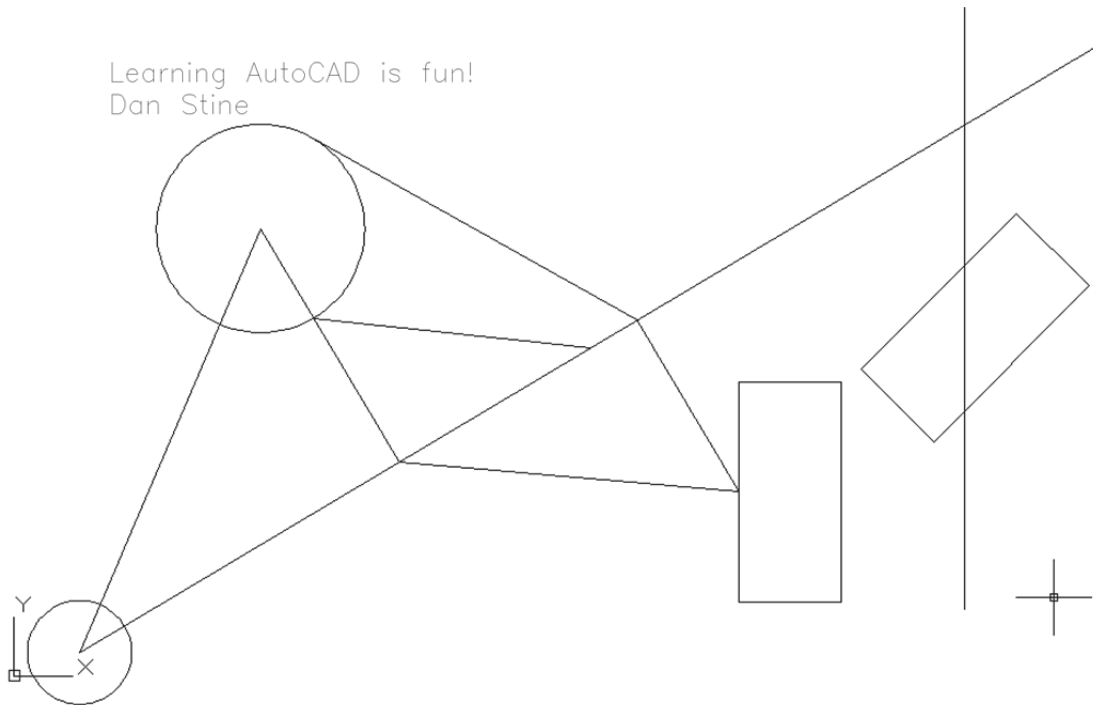

FIGURE 2-4.4 Mtext; final results of text entered

When modifying previously typed text (i.e., bold, underline, text height, etc.) you must select the text within the text edit window. To do this you drag the cursor over the desired text until it is highlighted.

TIP: *With the Mtext Editor open (Figure 2-4.3), you can Copy/Paste text in from other programs such as MS Word. Most of the formatting (e.g., font, bold, underline, etc.) will be preserved.*

Exercise 2-5: Printing

The final exercise in this lesson will cover another essential feature in CAD, which is printing. Printing takes some time to fully understand. It will be covered more, later in this book (Lesson 10).



Print Room in a large architectural firm

Image courtesy of BWBR Architects
www.bwbr.com

In this exercise you will print to an 8 1/2" x 11" piece of paper with the drawing filling the paper (i.e., not to scale).

1. Open drawing **ex2-4.dwg**.
2. Use the **Zoom** tools if required to display the portion of drawing shown in Figure 2-4.4.
3. Select the **Plot** icon from the *Quick Access* toolbar (called *print* in other programs).
 
 - a. You can also select *Print* → *Plot* from the *Application Menu*

You are now in the *Plot* dialog box. This is where you tell AutoCAD what printer or plotter to use, what scale and what size paper, to name a few examples (Figure 2-5.1).

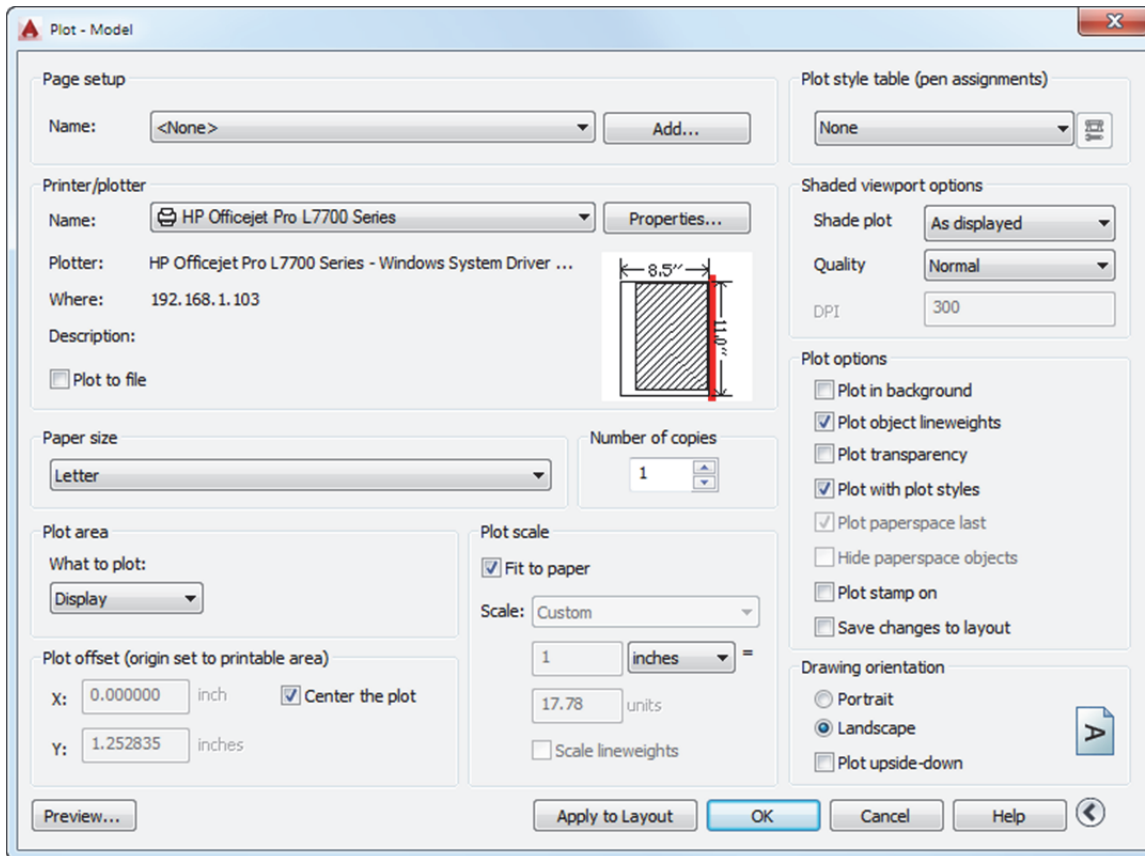

FIGURE 2-5.1 Plot Dialog Box; basic options

4. Make the following adjustments (Figure 2-5.1):
 - a. Select a **Printer** you have access to.
 - b. Paper size: **Letter (8.5 x 11 in.)**
 - c. What to plot: **Display**
 - d. **Center the plot:** *checked*
 - e. Plot scale: **Fit to paper** *checked*
 - f. Drawing Orientation: **Landscape** *checked*

***FYI:** The Display option (item 4c above) will only plot what is visible on screen; that is why you need to zoom in or out per Step 2.*

It is possible to hide some information in this dialog. You would not typically want to do this. But in case you accidentally do this, we will take a quick look at this before plotting.

5. Click the **Less Options** arrow in the lower right corner of the *Plot* dialog box (Figure 2-5.1).
6. Now, to restore the hidden information, click the **More Options** arrow.

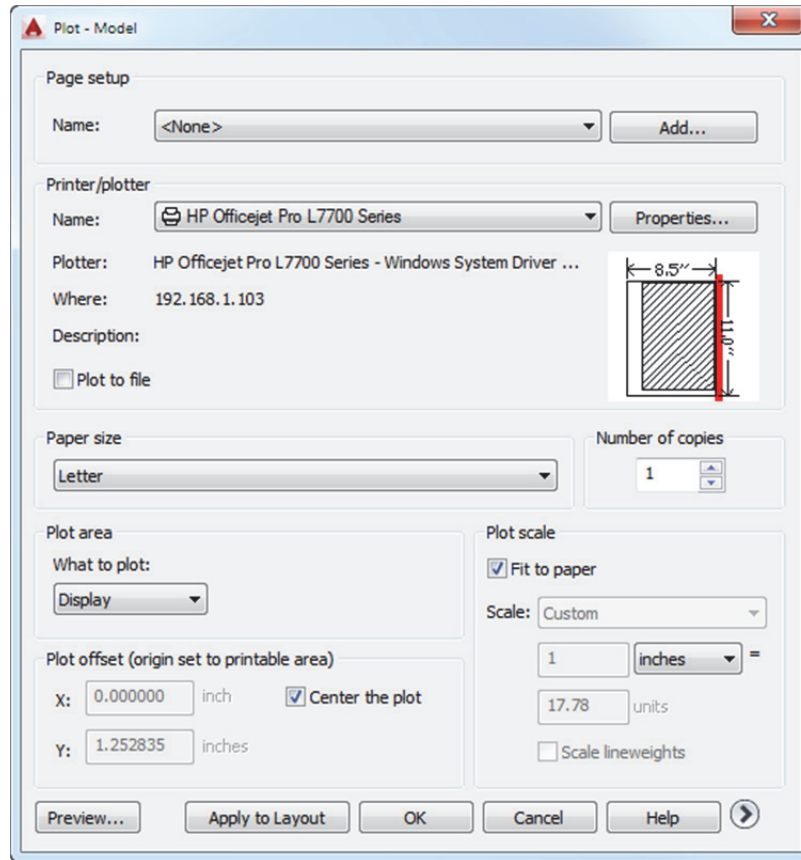

FIGURE 2-5.2 Plot Dialog Box; less options

AutoCAD can print to any printer/plotter installed on your computer. AutoCAD provides a few extra options in the device list for creating PDF and Image files. Selecting **DWG to PDF** will create a high quality PDF of your drawing, which can be emailed to a client or contractor for example.

A Printer is an output device that uses smaller paper (e.g., 8 1/2"x11" or 11"x17"). A Plotter is an output device that uses larger paper; plotters typically have one or more rolls of paper ranging in size from 18" wide to 36" wide. A roll feed plotter has a built-in cutter that can, for example, cut paper from a 36" wide roll to make 24"x36" sheets.



Plotter with three paper rolls



Color printer / copier

7. Click **OK** to send the plot (print); *if you actually want to print a page now.*

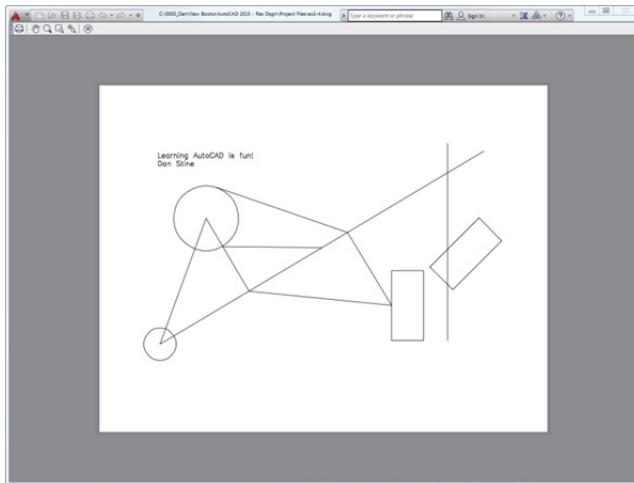

Using PREVIEW...

Before you click **OK**, it is a good idea to click the **Preview** button first. This will show how your drawing will look on the size paper selected.

Doing a *Preview* first will save time and paper.

Lesson 2 Recap:

In this lesson, *Crash Course Introduction (the Basics)*, you learned how to draw accurate lines and circles, use the *Object Snap* feature for precise pick points, use a handful of *Modify* tools (e.g., Copy, Move, Rotate and Scale). You also had a brief introduction to creating text and plotting. You should have a well-balanced amount of base knowledge to begin creating more meaningful objects, which is what you will do in the next lesson!

Self-Exam:

The following questions can be used as a way to check your knowledge of this lesson. The answers can be found at the bottom of this page.

1. AutoCAD is only accurate to 3 decimal places. (T/F)
2. The diamond shaped *OSNAP* symbol represents the *Midpoint* snap. (T/F)
3. “Full Preview” in the *Plot* dialog WILL save you time and paper. (T/F)
4. Use the _____ command to duplicate objects.
5. When selecting entities, use the _____ _____ to select all the entities in the selection window and all entities that extend through it.

Review Questions:

The following questions may be assigned by your instructor as a way to assess your knowledge of this section. Your instructor has the answers to the review questions.

1. AutoCAD is a raster based program. (T/F)
2. The Base Point you select for Rotate and Scale is not important. (T/F)
3. Entering 16 for a distance, actually means 16'-0" to AutoCAD. (T/F)
4. Use the _____ command to create squares.
5. You can change the height of the text while in the *Mtext* editor. (T/F)
6. Selecting this icon  ws you to _____ one or more entities in a drawing.
7. What is the name of the *template* file you are to use when creating a new drawing in this book? _____
8. With the **Rotate** command, typing 45 for the degrees prompt, rotates the entities in the _____ direction; whereas -45 rotates the entities in the _____ direction.
9. List all the *OSNAP* points available on a circle (ex. Line: endpoint, midpoint, nearest) _____.
10. The **OSNAP** button on the *Status Bar* must be “pushed in” (i.e., on) to automatically and accurately select snap points while drawing. (T/F)

SELF-EXAM ANSWERS:

1 – F, 2 – F, 3 – T, 4 – Copy, 5 – Crossing Window

Notes: