

Parametric Modeling with Creo® Parametric 3.0

NEW
Sheet Metal Design

An Introduction to Creo® Parametric 3.0

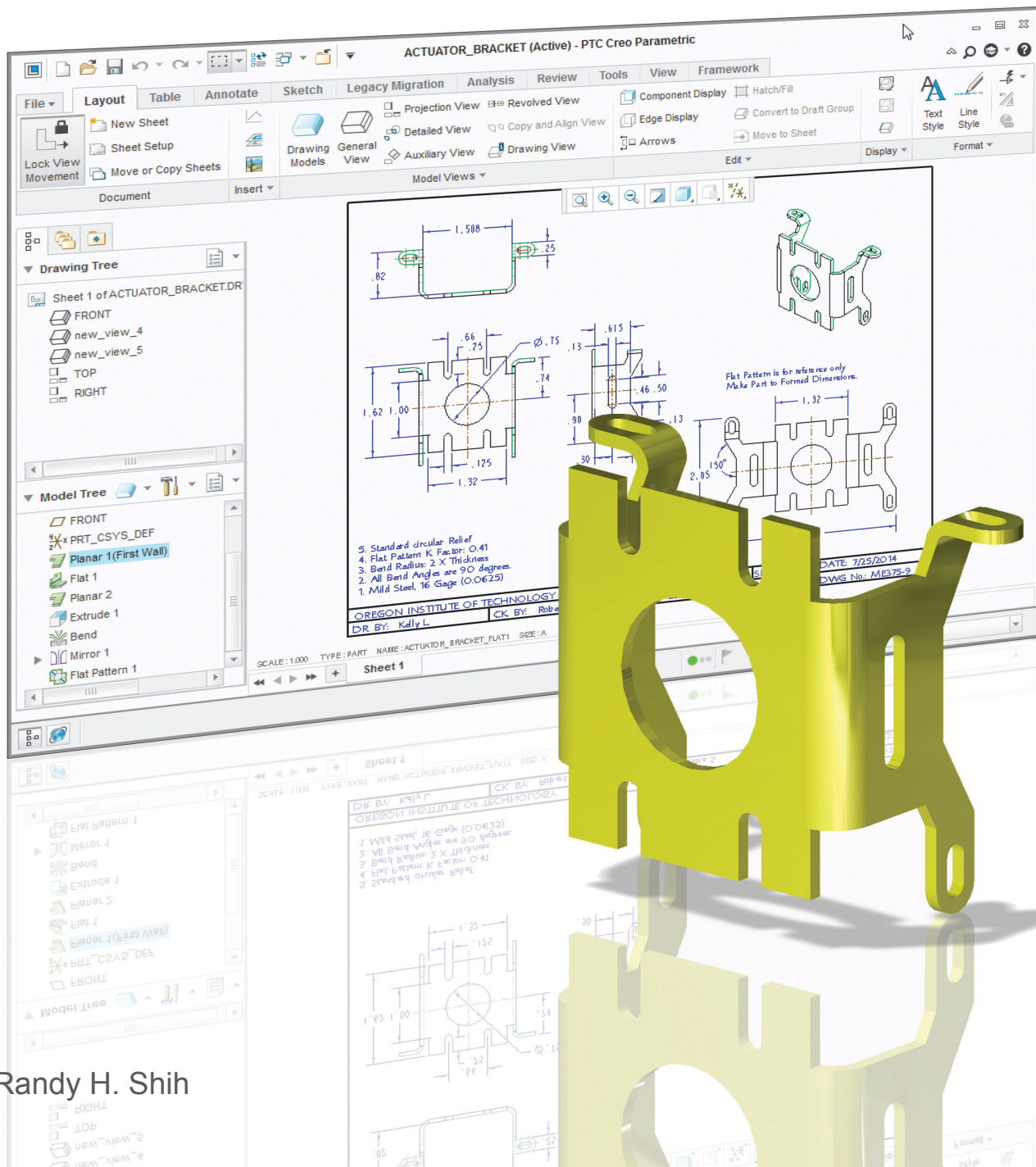

Randy H. Shih

Visit the following websites to learn more about this book:



[amazon.com](https://www.amazon.com)

[Google books](https://books.google.com)

[BARNES & NOBLE](https://www.barnesandnoble.com)

Chapter 1

Parametric Modeling Fundamentals

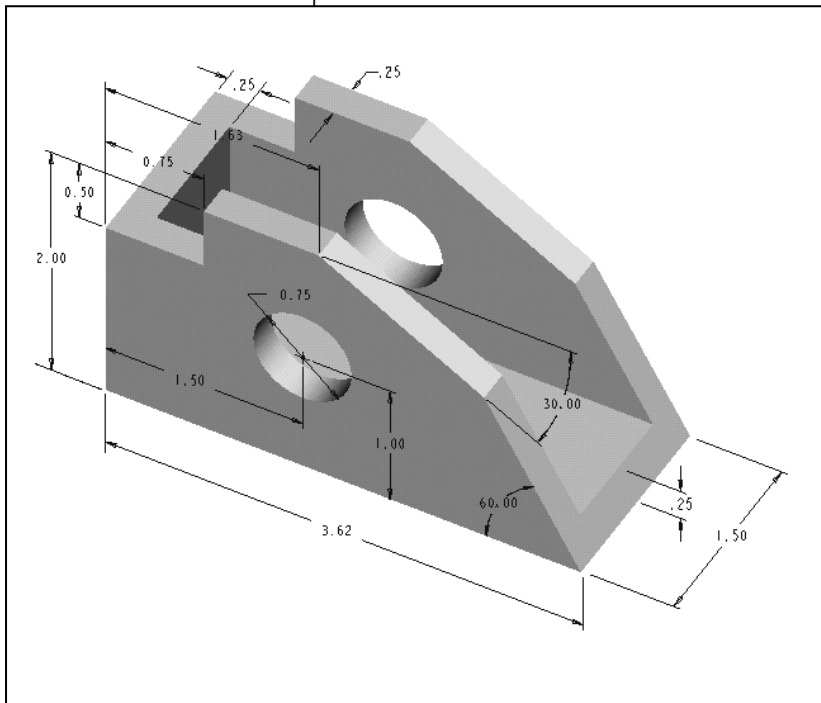

Learning Objectives

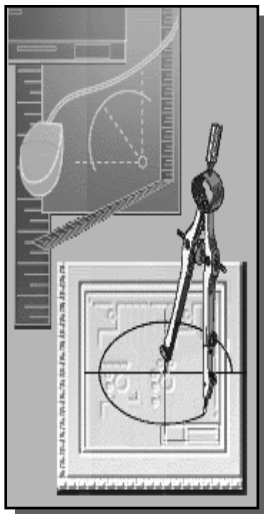

- ◆ Create Simple Extruded Solid Models.
- ◆ Understand the Basic Parametric Modeling Process.
- ◆ Create 2-D Sketches.
- ◆ Understand the "Shape before Size" approach.
- ◆ Use the Dynamic Viewing commands.
- ◆ Create and Modify Parametric Dimensions.

Introduction

The **feature-based parametric modeling** technique enables the designer to incorporate the original **design intent** into the construction of the model. The word *parametric* means the geometric definitions of the design, such as dimensions, can be varied at any time in the design process. Parametric modeling is accomplished by identifying and creating the key features of the design with the aid of computer software. The design variables, described in the sketches and features, can be used to quickly modify/update the design.

In *Creo Parametric*, the parametric part modeling process involves the following steps:

1. **Set up Units and Basic Datum Geometry.**
2. **Determine the type of the base feature, the first solid feature, of the design. Note that *Extrude*, *Revolve*, or *Sweep* operations are the most common types of base features.**
3. **Create a rough two-dimensional sketch of the basic shape of the base feature of the design.**
4. **Apply/modify constraints and dimensions to the two-dimensional sketch.**
5. **Transform the two-dimensional parametric sketch into a 3D feature.**
6. **Add additional parametric features by identifying feature relations and complete the design.**
7. **Perform analyses/simulations, such as finite element analysis (FEA) or cutter path generation (CNC), on the computer model and refine the design as needed.**
8. **Document the design by creating the desired 2D/3D drawings.**

The approach of creating three-dimensional features using two-dimensional sketches is an effective way to construct solid models. Many designs are in fact the same shape in one direction. Computer input and output devices we use today are largely two-dimensional in nature, which makes this modeling technique quite practical. This method also conforms to the design process that helps the designer with conceptual design along with the capability to capture the *design intent*. Most engineers and designers can relate to the experience of making rough sketches on restaurant napkins to convey conceptual design ideas. Note that *Creo Parametric* provides many powerful modeling and design tools, and there are many different approaches to accomplish modeling tasks. The basic principle of **feature-based modeling** is to build models by adding simple features one at a time. In this chapter, a very simple solid model with extruded features is used to introduce the general **feature-based parametric** modeling procedure.

The *Adjuster* design

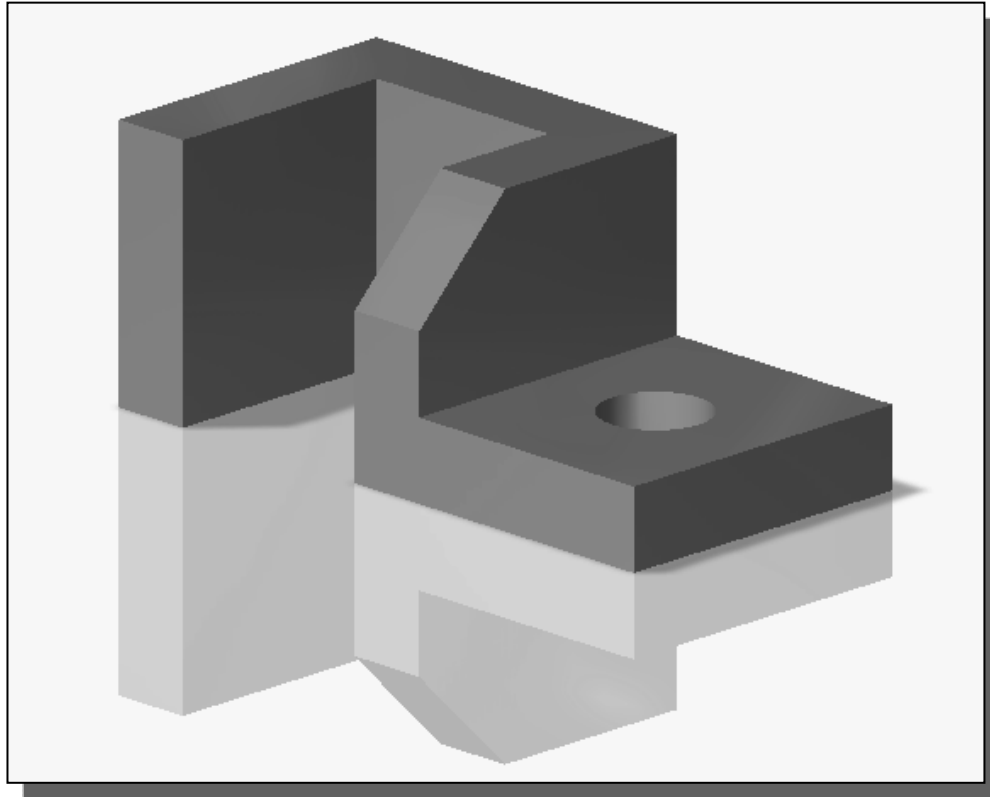

Starting *Creo Parametric*

- How to start *Creo Parametric* depends on the type of workstation and the particular software configuration you are using. With most *Windows* and *UNIX* systems, you may select **Creo Parametric** on the *Start* menu or select the **Creo Parametric** icon on the desktop. Consult your instructor or technical support personnel if you have difficulty starting the software.
1. Select the **Creo Parametric** option on the *Start* menu or select the **Creo Parametric** icon on the desktop to start *Creo Parametric*. The *Creo Parametric* main window will appear on the screen.

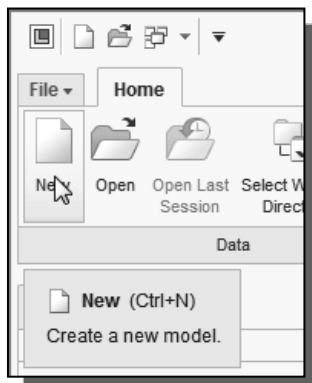

2. Close the *Welcome to Creo* window by clicking on the [X] icon near the upper right corner of the window.
3. Click on the **New** icon, located in the *Ribbon* toolbar as shown.

- In the *New* dialog box, confirm the model's Type is set to **Part (Solid Sub-type)**.



- Enter **Adjuster** as the part Name as shown in the figure.
- Turn *off* the **Use default template** option.
- Click on the **OK** button to accept the settings.

- In the *New File Options* dialog box, select **EMPTY** in the option list to not use any template file.
- Click on the **OK** button to accept the settings and enter the *Creo Parametric Part Modeling* mode.

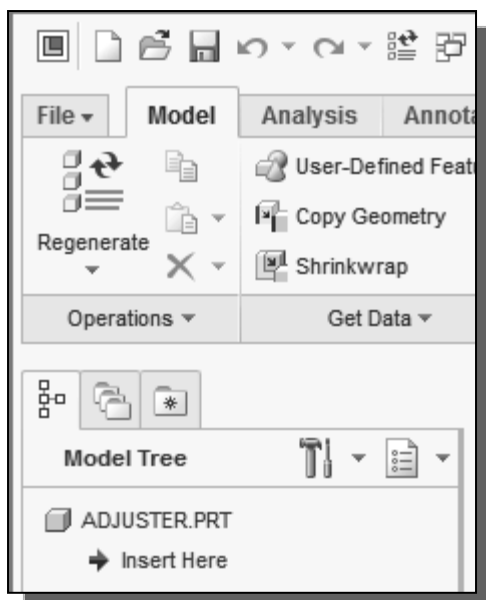
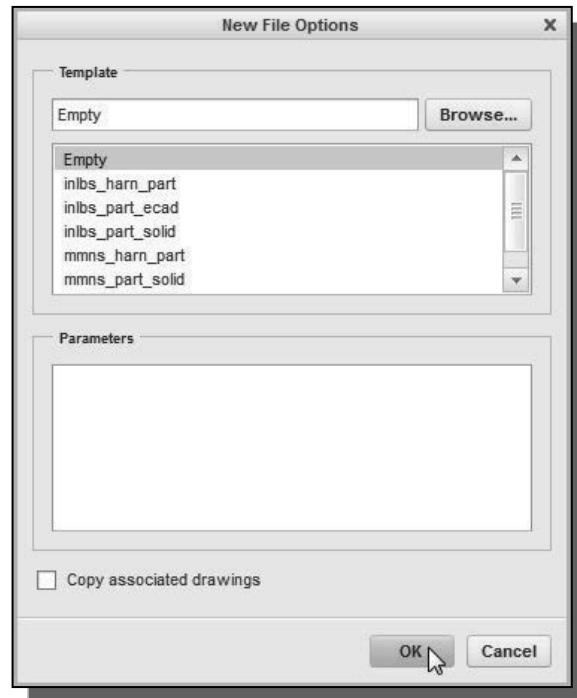

- Note that the part name, *Adjuster.prt*, appears in the *Navigator Model Tree* window and the title bar area of the main window.

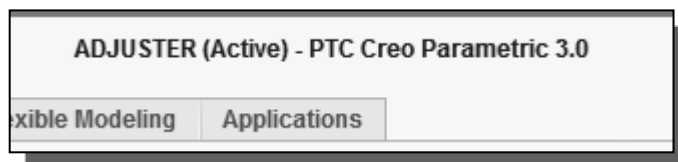

Step 1: Units and Basic Datum Geometry Setups

◆ Units Setup

When starting a new model, the first thing we should do is to choose the set of units we want to use.

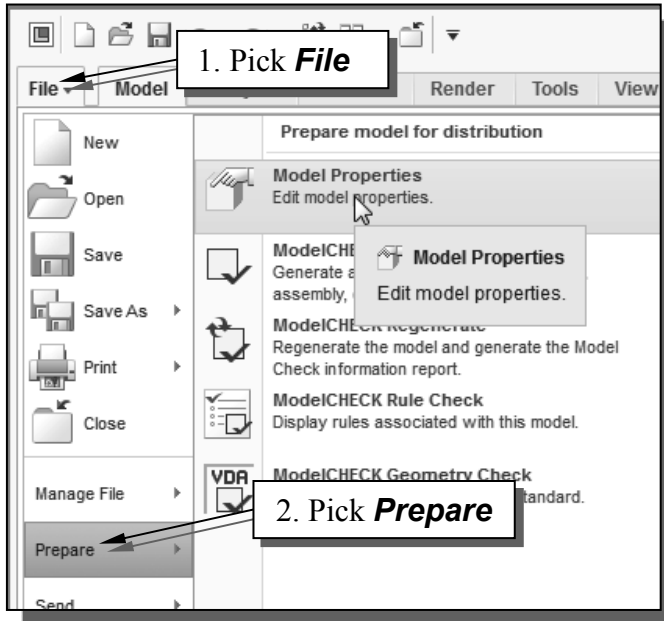

1. Use the left-mouse-button and select **File** in the pull-down menu area.
2. Use the left-mouse-button and select **Prepare** in the **pull-down list** as shown.
3. Select **Model Properties** in the *expanded list* as shown

➤ Note that the *Creo Parametric* menu system is context-sensitive, which means that the menu items and icons of the non-applicable options are grayed out (temporarily disabled).

4. Select the **Change** option that is to the right of the **Units** option in the *Model Properties* window.

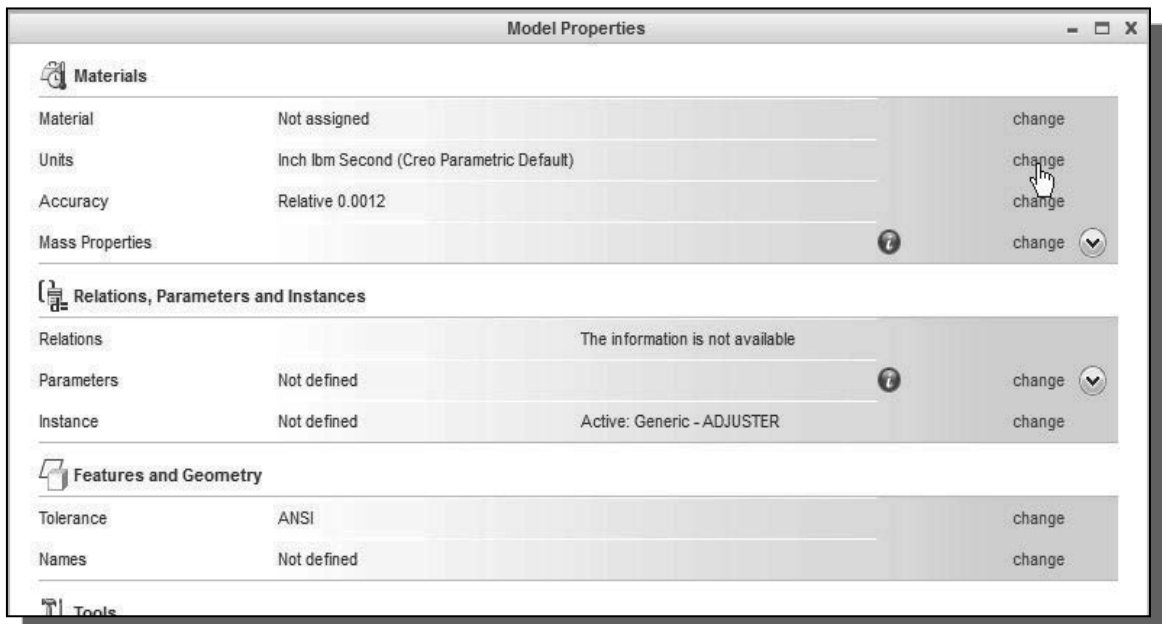



5. In the **Units Manager – Systems of Units** form, the *Creo Parametric* default setting **Inch lbm Second** is displayed. The set of units is stored with the model file when you save. Pick **Inch Pound Second (IPS)** by clicking in the list window as shown.

6. Click on the **Set** button to accept the selection. Notice the arrow in the Units list now points toward the **Inch Pound Second (IPS)** units set.

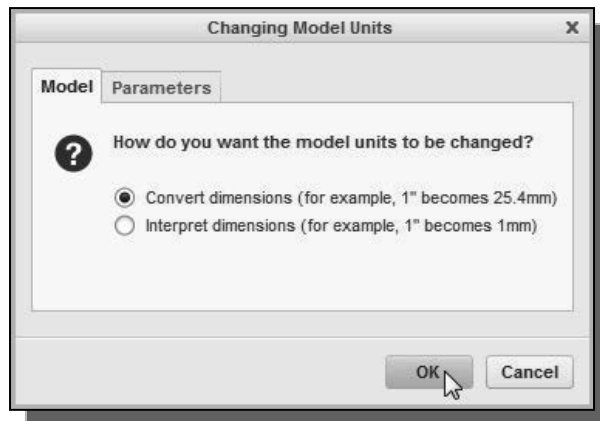
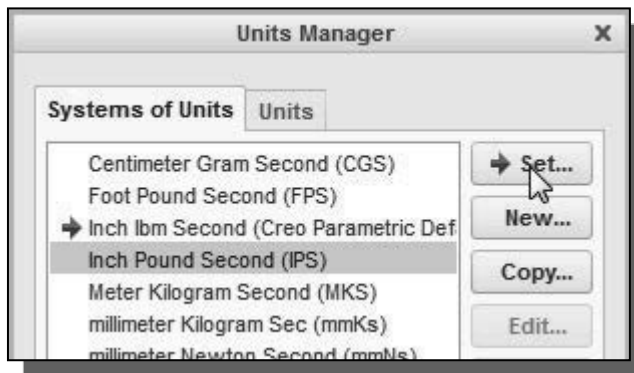

7. In the *Changing Model Units* dialog box, click on the **OK** button to accept the default option to change of the units.

➤ Note that *Creo Parametric* allows us to change model units even after the model has been constructed; we can change the units by (1) *Convert dimensions* or (2) *Interpret dimensions*.

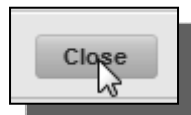

8. Click on the **Close** button to exit the *Units Manager* dialog box.

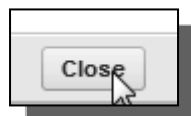

9. Pick **Close** to exit the *Model Properties* window.

➤ **Adding the First Part Features – Datum Planes**

❖ *Creo Parametric* provides many powerful tools for model creation. In doing feature-based parametric modeling, it is a good practice to establish three reference planes to locate the part in space. The reference planes can be used as location references in feature constructions.

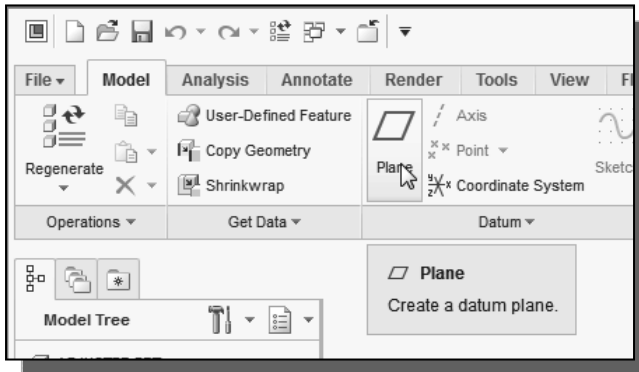

1. Move the cursor to the **Datum** toolbar on the *Ribbon* toolbar and click on the **Datum Plane** tool icon as shown.

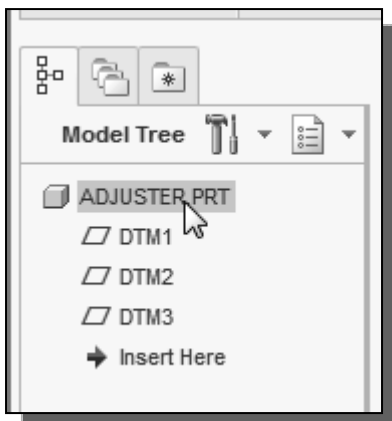
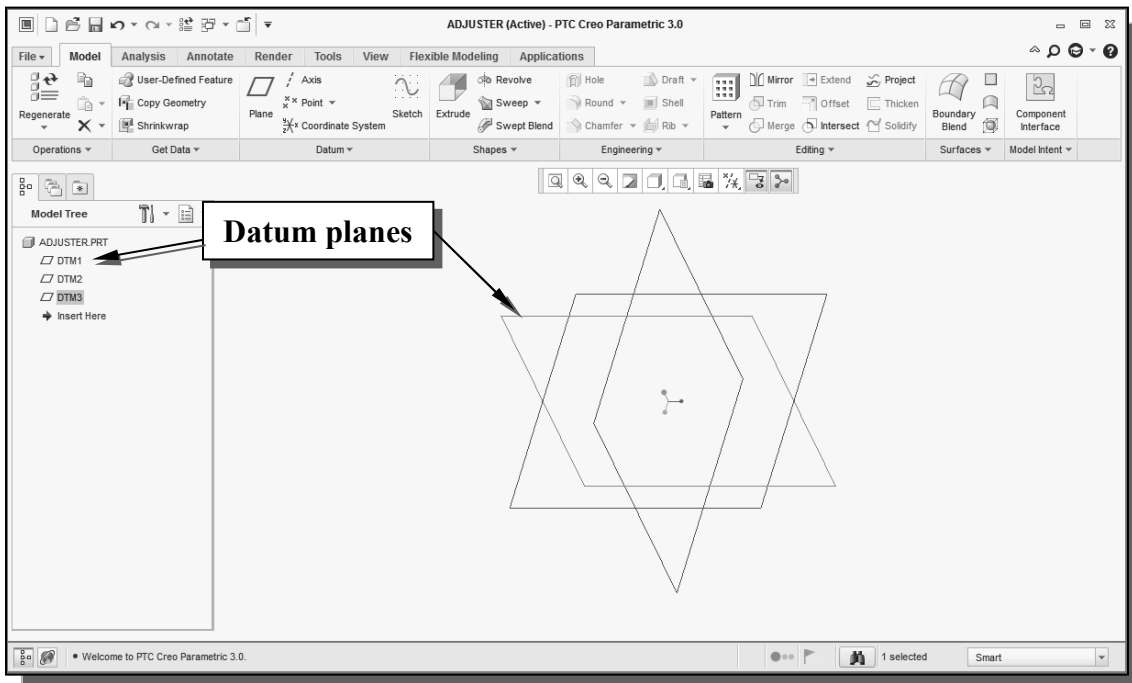

❖ In the *Navigator Model Tree* window and the display area, three datum planes represented by three rectangles are displayed. Datum planes are infinite planes and they are perpendicular to each other. We can consider these planes as XY, YZ, and ZX planes of a Cartesian coordinate system.

2. Click the model name, **Adjuster.prt**, in the *Navigator* window to **deselect** the last created feature.

➤ **Switching On the Plane Tag Display**

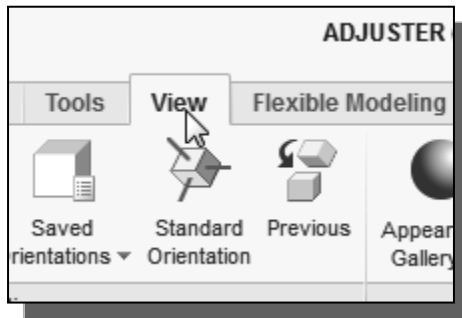

1. Click on the **View** tab in the Ribbon toolbar to show the view related commands in Creo.

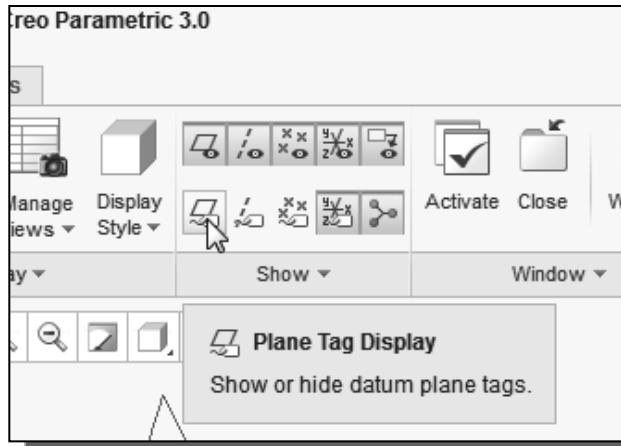

2. Click on the **Plane Tag Display** icon to switch on the display of the plane tag as shown.

➤ Note the other options available to display the **Axis Tag** and/or **Point Tag**.

➤ In the graphics area, note the datum planes now are shown with the associated names.

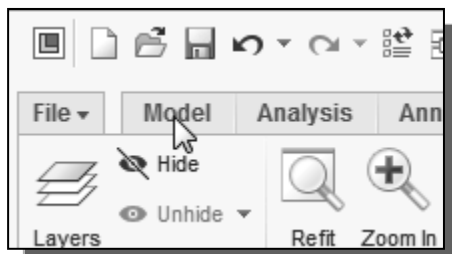
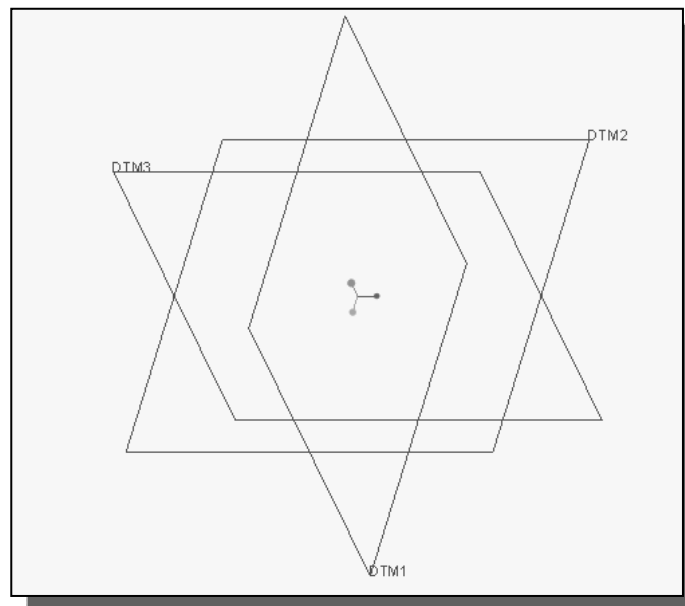

3. Click on the **Model** tab in the Ribbon toolbar to return to the Model toolbar as shown.

Step 2: Determine/Setup the Base Solid Feature

- For the *Adjuster* design, we will create an extruded solid as the base feature.

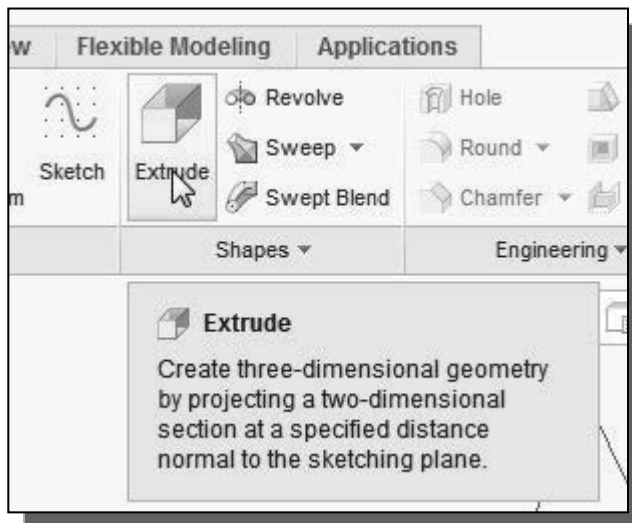

1. In the *Shapes* toolbar (the fourth group in the *Ribbon* toolbar), click on the **Extrude** tool icon as shown.

- The *Feature Option Dashboard*, which contains applicable construction options, is displayed in the *Ribbon* toolbar of the *Creo Parametric* main window.

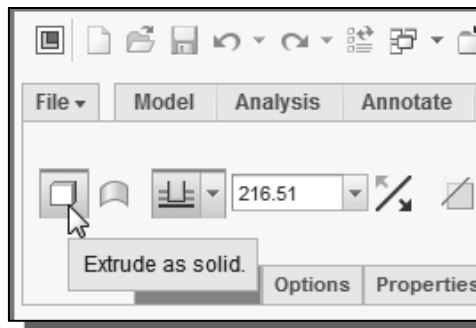
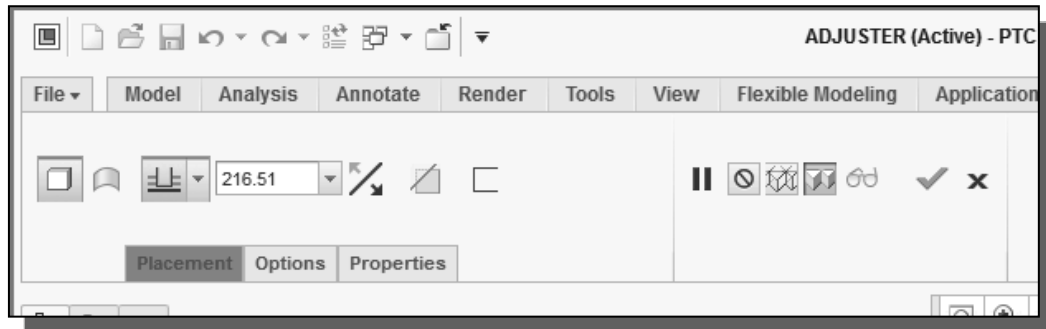

2. On your own, move the cursor over the icons and read the descriptions of the different options available. Note that the default extrude option is set to **Extrude as solid**.

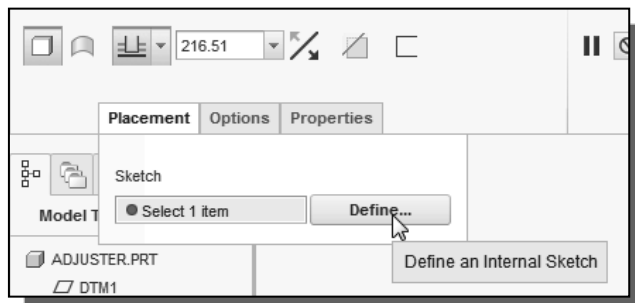

3. Click the **Placement** option and choose **Define** to begin creating a new *internal sketch*.

Sketching plane – It is an XY CRT, but an XYZ World

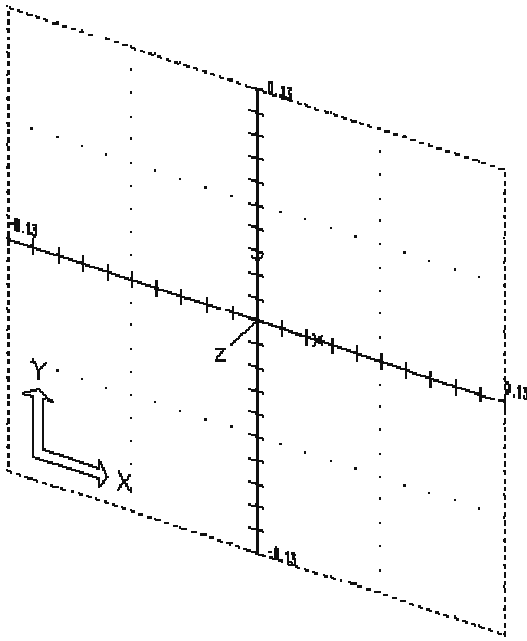

Design modeling software is becoming more powerful and user friendly, yet the system still does only what the user tells it to do. When using a geometric modeler, we therefore need to have a good understanding of what its inherent limitations are. We should also have a good understanding of what we want to do and what to expect, as the results are based on what is available.

In most 3D geometric modelers, 3D objects are located and defined in what is usually called **world space** or **global space**. Although a number of different coordinate systems can be used to create and manipulate objects in a 3D modeling system, the objects are typically defined and stored using the world space. The world space is usually a **3D Cartesian coordinate system** that the user cannot change or manipulate.

In most engineering designs, models can be very complex, and it would be tedious and confusing if only the world coordinate system were available. Practical 3D modeling systems allow the user to define **Local Coordinate Systems (LCS)** or **User Coordinate Systems (UCS)** relative to the world coordinate system. Once a local coordinate system is defined, we can then create geometry in terms of this more convenient system.

Although objects are created and stored in 3D space coordinates, most of the geometric entities can be referenced using 2D Cartesian coordinate systems. Typical input devices such as a mouse or digitizer are two-dimensional by nature; the movement of the input device is interpreted by the system in a planar sense. The same limitation is true of common output devices, such as CRT displays and plotters. The modeling software performs a series of three-dimensional to two-dimensional transformations to correctly project 3D objects onto the 2D display plane.

The *Creo Parametric sketching plane* is a special construction approach that enables the planar nature of the 2D input devices to be directly mapped into the 3D coordinate system. The *sketching plane* is a local coordinate system that can be aligned to an existing face of a part, or a reference plane.

Think of the sketching plane as the surface on which we can sketch the 2D sections of the parts. It is similar to a piece of paper, a white board, or a chalkboard that can be attached to any planar surface. The first sketch we create is usually drawn on one of the established datum planes. Subsequent sketches/features can then be created on sketching planes that are aligned to existing **planar faces of the solid part** or **datum planes**.

Defining the Sketching Plane

- The *sketching plane* is a reference location where two-dimensional sketches are created. The *sketching plane* can be any planar part surface or datum plane. Note that *Creo Parametric* uses a two-step approach in setting up the selection and alignment of the sketching plane.

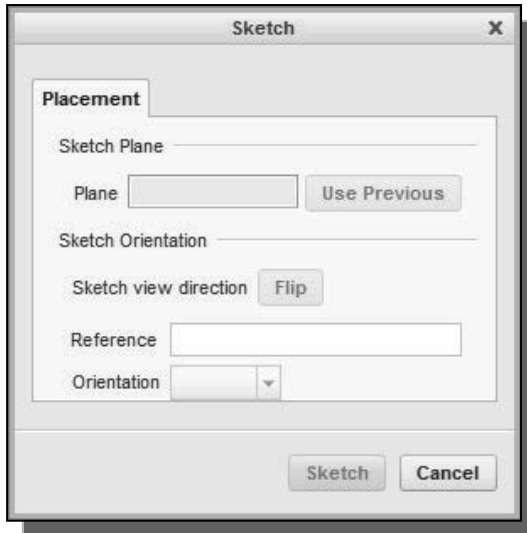

- In the *Section Placement* window, the selection of the sketch plane and the orientation of the sketching plane are organized into two groups as shown in the figure. The **Sketch Plane** can be set to any surfaces, including datum planes. The **Sketch Orientation** is set based on the selection of the Sketch plane.

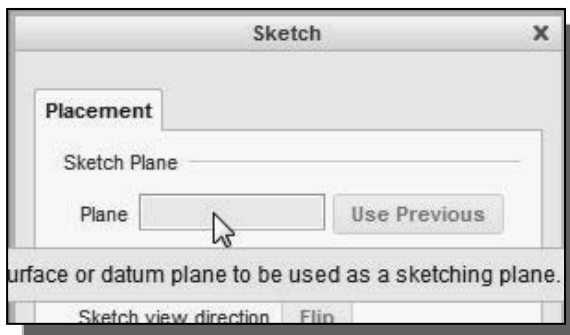

- Notice the **Plane** option box in the *Sketch* window is activated, and the message “*Select a plane or surface to define sketch plane.*” is displayed in the quick help tip and also in the message area.

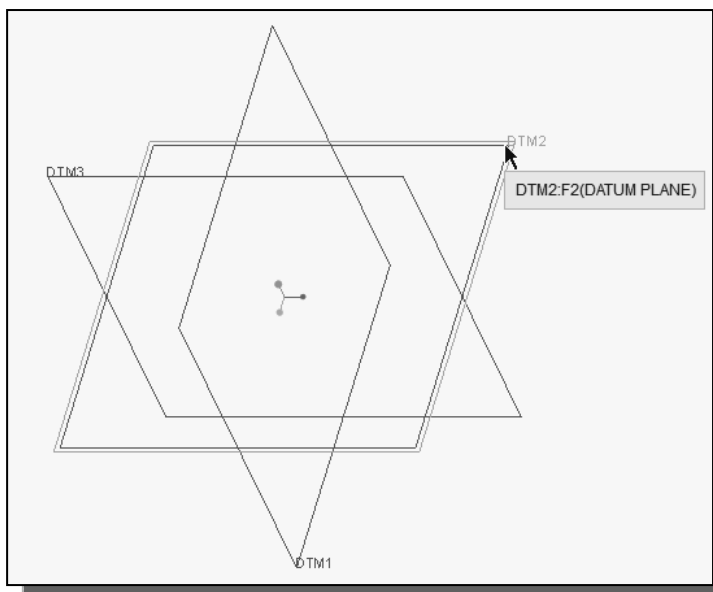

- In the *graphic area*, select **DTM2** by clicking on any edge of the plane as shown.

- Notice an arrow appears on the left edge of **DTM2**. The arrow direction indicates the viewing aligned direction of the sketch plane. The viewing direction can be reversed by clicking on the **Flip** button in the *Sketch Orientation* section of the popup window.

Defining the Orientation of the Sketching Plane

- Although we have selected the sketching plane, *Creo Parametric* still needs additional information to define the orientation of the sketch plane. *Creo Parametric* expects us to choose a reference plane (any plane that is perpendicular to the selected sketch plane) and the orientation of the reference plane is relative to the computer screen.
- **To define the orientation of the sketching plane, select the facing direction of the reference plane with respect to the computer screen.**

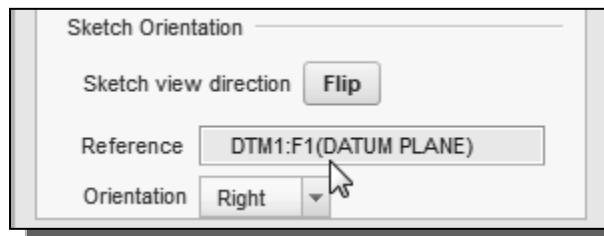
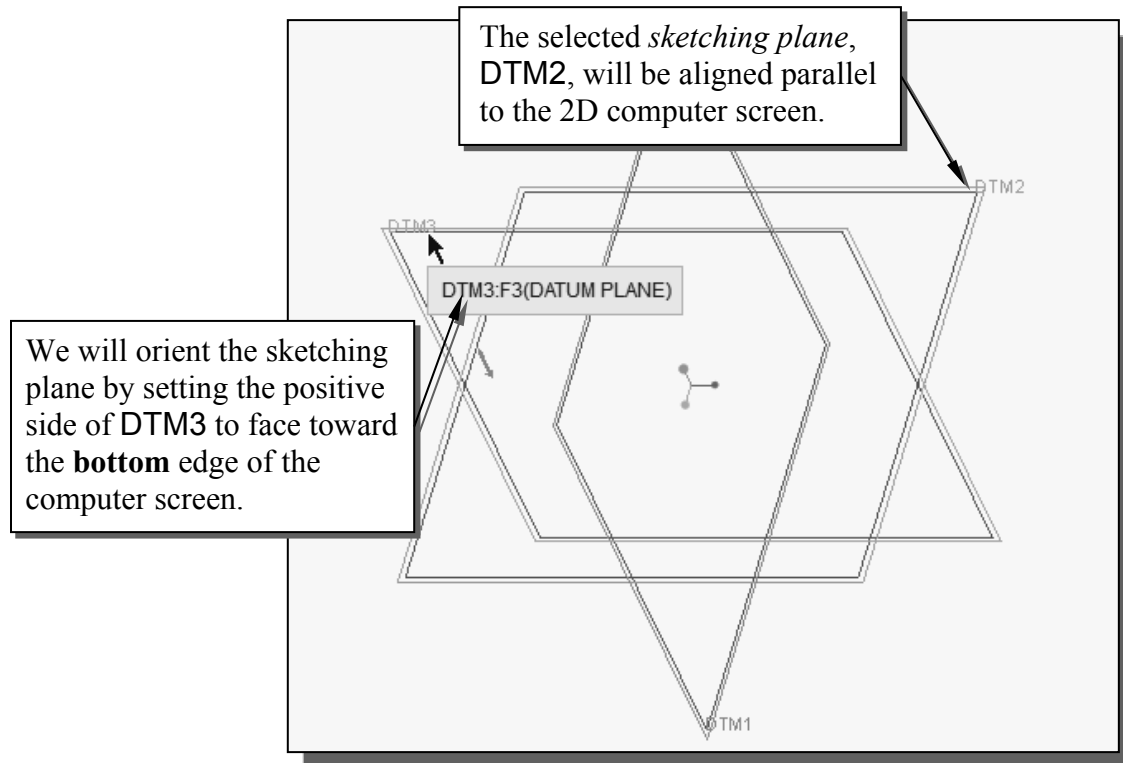

1. Notice the **Reference** option box in the Sketch Orientation window is now activated. The message "Select a reference, such as surface, plane or edge to define view orientation." is displayed in the message area.

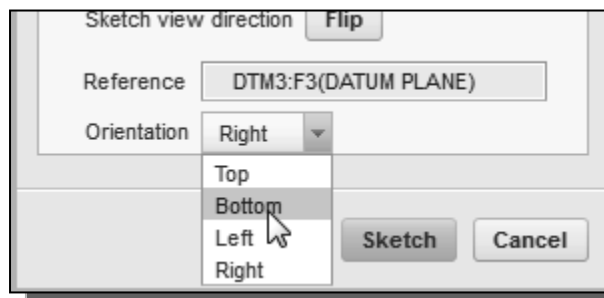

2. In the *graphic area*, select **DTM3** by clicking on one of the datum plane edges as shown in the above figure.
3. In the **Orientation** list, pick **Bottom** to set the orientation of the reference plane.

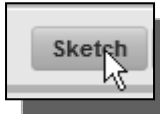

4. Pick **Sketch** to exit the *Section Placement* window and proceed to enter the *Creo Parametric Sketcher* mode.

5. To orient the sketching plane parallel to the screen, click on the **Sketch View** icon in the *Display View* toolbar as shown. Note the orientation of the sketching plane is adjusted based on the setup on the previous page.

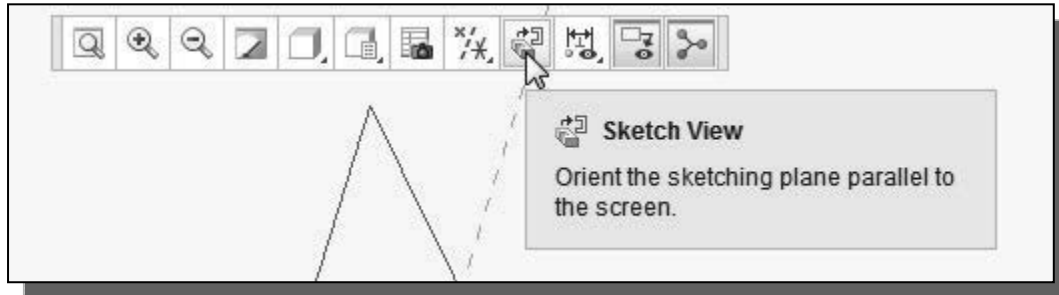

- *Creo Parametric* will now rotate the three *datum planes*: DTM2 aligned to the screen and the positive side of DTM3 facing toward the bottom edge of the computer screen.

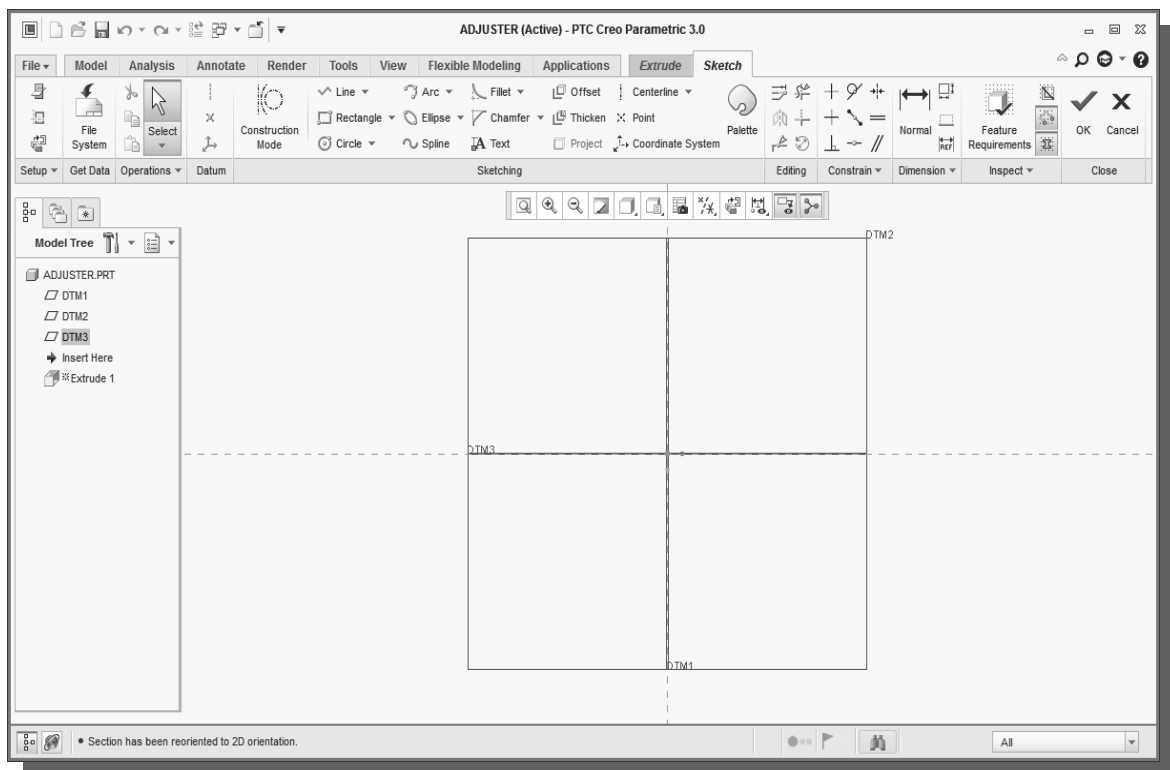

- ❖ The orientation of the *sketching plane* can be very confusing to new users. Read through this section carefully again to make sure you understand the steps involved.

Step 3: Creating 2D Rough Sketches

◆ Shape Before Size – Creating Rough Sketches

Quite often during the early design stage, the shape of a design may not have any precise dimensions. Most conventional CAD systems require the user to input the precise lengths and location dimensions of all geometric entities defining the design, and some of the values may not be available during the early design stage. With *parametric modeling*, we can use the computer to elaborate and formulate the design idea further during the initial design stage. With *Creo Parametric*, we can use the computer as an electronic sketchpad to help us concentrate on the formulation of forms and shapes for the design. This approach is the main advantage of *parametric modeling* over conventional solid-modeling techniques.

As the name implies, *rough sketches* are not precise at all. When sketching, we simply sketch the geometry so it closely resembles the desired shape. Precise scale or dimensions are not needed. *Creo Parametric* provides us with many tools to assist in finalizing sketches, known as *sections*. For example, geometric entities such as horizontal and vertical lines are set automatically. However, if the rough sketches are poor, much more work will be required to generate the desired parametric sketches. Here are some general guidelines for creating sketches in *Creo Parametric*:

- **Create a sketch that is proportional to the desired shape.** Concentrate on the shapes and forms of the design.
 - **Keep the sketches simple.** Leave out small geometry features such as fillets, rounds, and chamfers. They can easily be placed using the **Fillet** and **Chamfer** commands after the parametric sketches have been established.
 - **Exaggerate the geometric features of the desired shape.** For example, if the desired angle is 85 degrees, create an angle that is 50 or 60 degrees. Otherwise, *Creo Parametric* might assume the intended angle to be a 90-degree angle.
 - **Draw the geometry so that it does not overlap.** The sketched geometry should eventually form a closed region. *Self-intersecting* geometric shapes are not allowed.
 - **The sketched geometric entities should form a closed region.** To create a solid feature, such as an extruded solid, a closed region section is required so that the extruded solid forms a 3D volume.
- **Note:** The concepts and principles involved in *parametric modeling* are very different, and sometimes they are totally opposite, to those of the conventional computer aided drafting systems. In order to understand and fully utilize *Creo Parametric*'s functionality, it will be helpful to take a *Zen* approach to learning the topics presented in this text: **Temporarily forget your knowledge and experiences using conventional computer aided drafting systems.**

◆ The Creo Parametric SKETCHER and INTENT MANAGER

In previous generation CAD programs, construction of models relies on exact dimensional values, and adjustments to dimensional values are quite difficult once the model is built. With *Creo Parametric*, we can now treat the sketch as if it is being done on a napkin, and it is the general shape of the design that we are more interested in defining. The *Creo Parametric* part model contains more than just the final geometry. It also contains the *design intent* that governs what will happen when geometry changes. The design philosophy of “**shape before size**” is implemented through the use of the *Creo Parametric Sketcher*. This allows the designer to construct solid models in a higher level and leave all the geometric details to *Creo Parametric*.

In *Creo Parametric*, previously known as Pro/ENGINEER, one of the more important functionalities is the *Intent Manager* in the *2D Sketcher*.

The *Intent Manager* enables us to do:

- Dynamic dimensioning and constraints
- Add or delete constraints explicitly
- Undo any *Sketcher* operation

The first thing that *Creo Parametric Sketcher* expects us to do, which is displayed in the *References* window, is to specify *sketching references*. In the previous sections, we created the three datum planes to help orient the model in 3D space. Now we need to orient the 2D sketch with respect to the three datum planes. At least two references are required to orient the sketch in the horizontal direction and in the vertical direction. By default, the two planes (in our example, DTM1 and DTM3) that are perpendicular to the sketching plane (DTM2) are automatically selected.

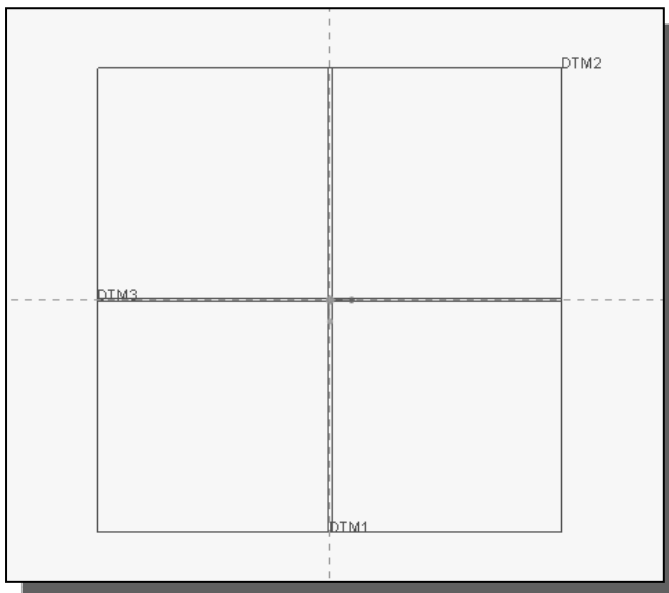

- Note that DTM1 and DTM3 are pre-selected as the sketching references. In the graphics area, the two references are displayed with two **dashed lines**.
- In *Creo Parametric*, a 2D sketch needs to be Fully Placed with respect to at least two references. In this case, DTM1 is used to control the horizontal placement of geometry, where DTM3 is used to control the vertical placements.

- ❖ Next, we will create a rough sketch by using some of the visual aids available, and then update the design through the associated control parameters.

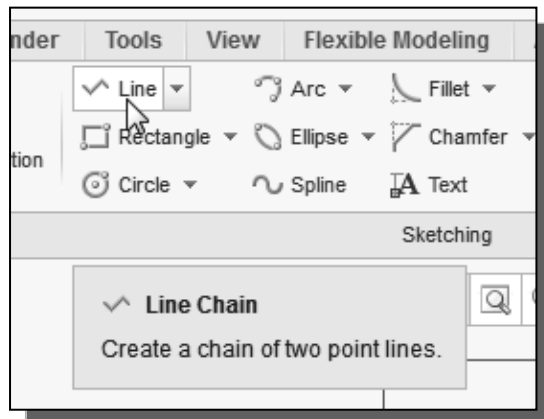

- Move the graphics cursor to the **Line** icon in the *Sketching* toolbar. A *help-tip* box appears next to the cursor to provide a brief description of the command.

- ❖ The *Sketching* toolbar provides tools for creating the basic 2D geometry that can be used to create features and parts.

Graphics Cursors

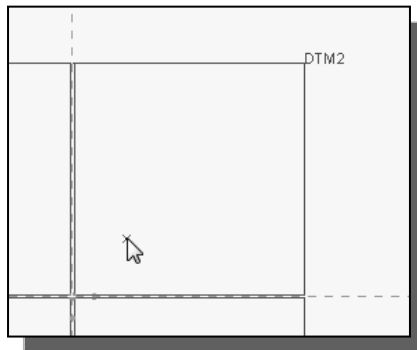

- ❖ Notice the cursor changes from an arrow to an arrow with a small crosshair when graphical input is expected.

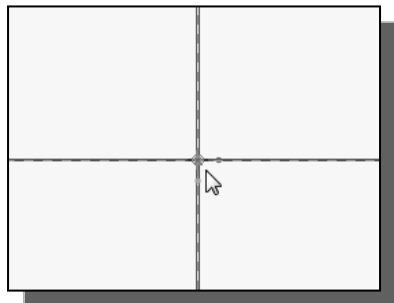

1. Move the cursor near the intersection of the two references, and notice that the small crosshair attached to the cursor will automatically snap to the intersection point. **Left-click** once to place the starting point as shown.



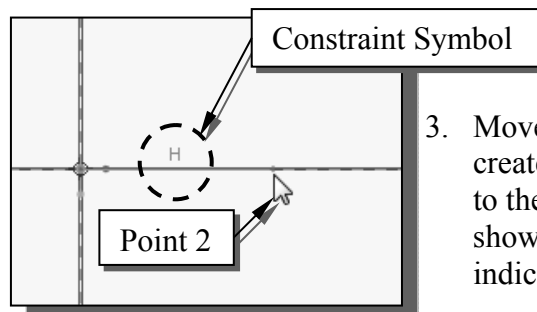

2. As you move the graphics cursor, you will see different symbols appear at different locations.



3. Move the cursor along the vertical reference and create a short horizontal line by clicking at a location to the right side of the starting point (**Point 2**) as shown. Notice the geometric constraint symbol, **H**, indicating the created line segment is Horizontal.

Geometric Constraint Symbols

❖ *Creo Parametric* displays different visual clues, or symbols, to show you alignments, perpendicularities, tangencies, etc. These constraints are used to capture the *design intent* by creating constraints where they are recognized. *Creo Parametric* displays the governing geometric rules as models are built.

V	Vertical	indicates a segment is vertical
H	Horizontal	indicates a segment is horizontal
L	Equal Length	indicates two segments are of equal length
R	Equal Radii	indicates two curves are of equal radii
T	Tangent	indicates two entities are tangent to each other
	Parallel	indicates a segment is parallel to other entities
	Perpendicular	indicates a segment is perpendicular to other entities
	Symmetry	indicates two points are symmetrical
	Point on Entity	indicates the point is on another entity

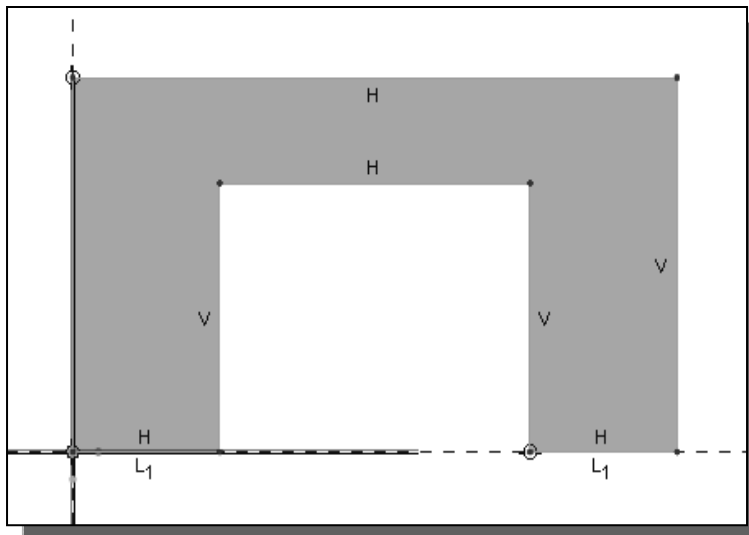

4. Complete the sketch as shown, a closed region ending at the starting point (**Point 1**). Watch the displayed constraint symbols while sketching, especially the **Equal Length** constraint, **L1**, applied to the two short horizontal edges.

➤ Note that all segments are either *vertical* or *horizontal*.

5. Inside the *graphics area*, click **twice** with the **middle-mouse-button** to end the current line sketch.

- ❖ *Creo Parametric's Intent Manager* automatically places dimensions and constraints on the sketched geometry. This is known as the ***Dynamic Dimensioning and Constraints*** feature. Constraints and dimensions are added “on the fly.” Do not be concerned with the size of the sketched geometry or the displayed dimensional values; we will modify the sketched geometry in the following sections.

Dynamic Viewing Functions

- ❖ *Creo Parametric* provides a special user interface, ***Dynamic Viewing***, which enables convenient viewing of the entities in the display area at any time. The ***Dynamic Viewing*** functions are controlled with the combinations of the middle mouse button, the [Ctrl] key and the [Shift] key on the keyboard.

Zooming – Turn the **mouse wheel** or [Ctrl] key and [middle-mouse-button]

Use the **mouse wheel** to perform the zooming option, turning the wheel forward will reduce the scale of display. Hold down the [Ctrl] key and press down the middle-mouse-button in the display area. Drag the mouse vertically on the screen to adjust the scale of the display. Moving upward will reduce the scale of the display, making the entities display smaller on the screen. Moving downward will magnify the scale of the display.

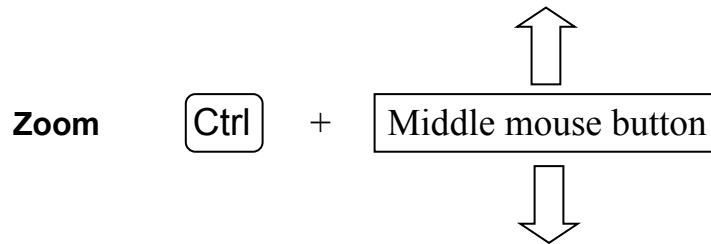

Panning – [Shift] key and [middle-mouse-button]

Hold down the [Shift] key and press down the middle-mouse-button in the display area. Drag the mouse to pan the display. This allows you to reposition the display while maintaining the same scale factor of the display. This function acts as if you are using a video camera. You control the display by moving the mouse.

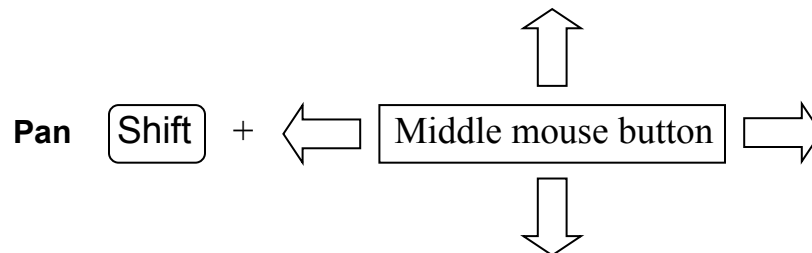

- On your own, use the *Dynamic Viewing* functions to reposition and magnify the scale of the 2D sketch to the center of the screen so that it is easier to work with.

Step 4: Apply/Modify Constraints and Dimensions

- As the sketch is made, *Creo Parametric* automatically applies geometric constraints (such as Horizontal, Vertical and Equal Length) and dimensions to the sketched geometry. We can continue to modify the geometry, apply additional constraints and/or dimensions, or define/modify the size and location of the existing geometry. It is more than likely that some of the automatically applied dimensions may not match with the design intent we have in mind. For example, we might want to have dimensions identifying the overall-height, overall-width, and the width of the inside-cut of the design, as shown in the figures below.

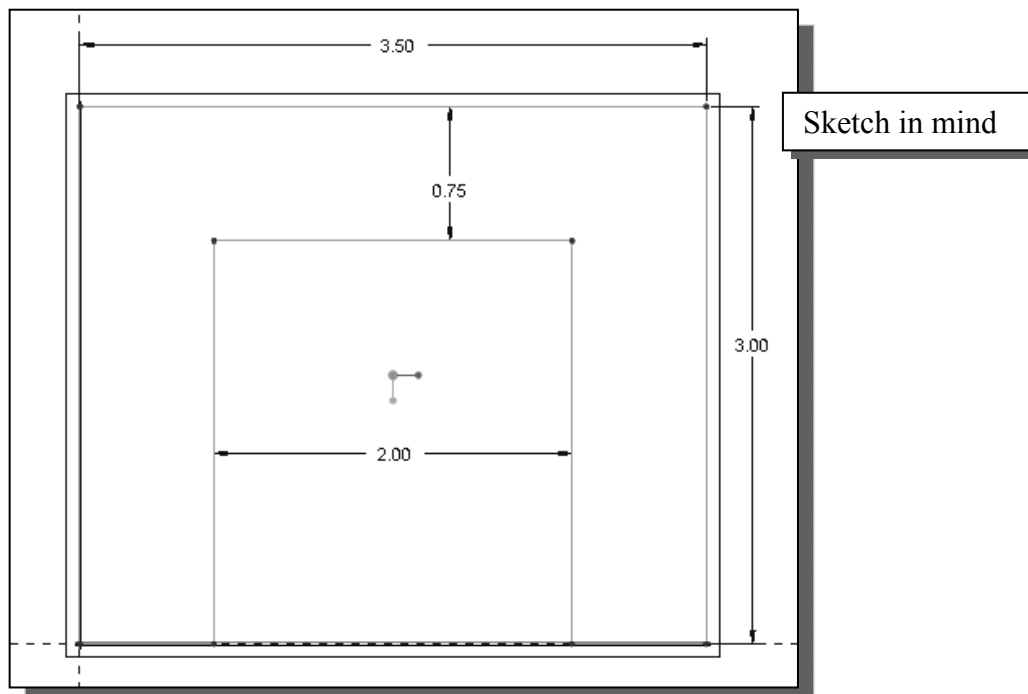
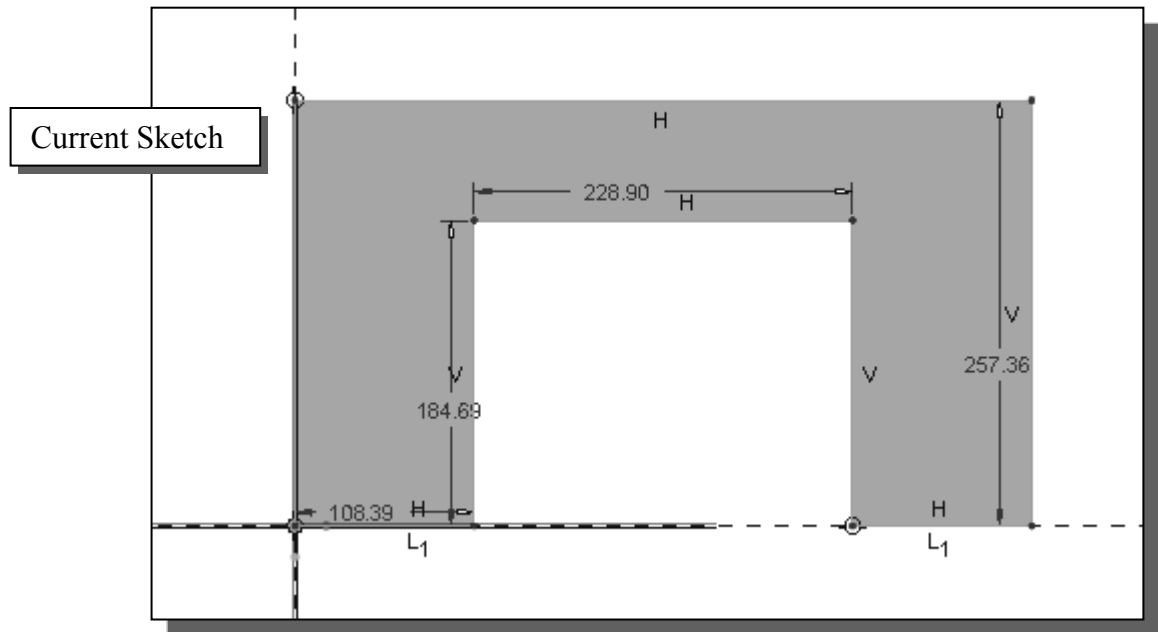

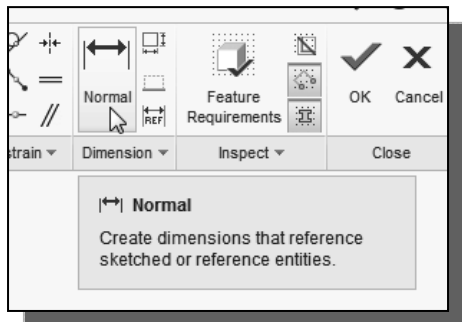

1. Click on the **Normal Dimension** icon in the *Sketching* toolbar as shown. This command allows us to create defining dimensions.
2. Select the **inside horizontal line** by left-clicking once on the line as shown.

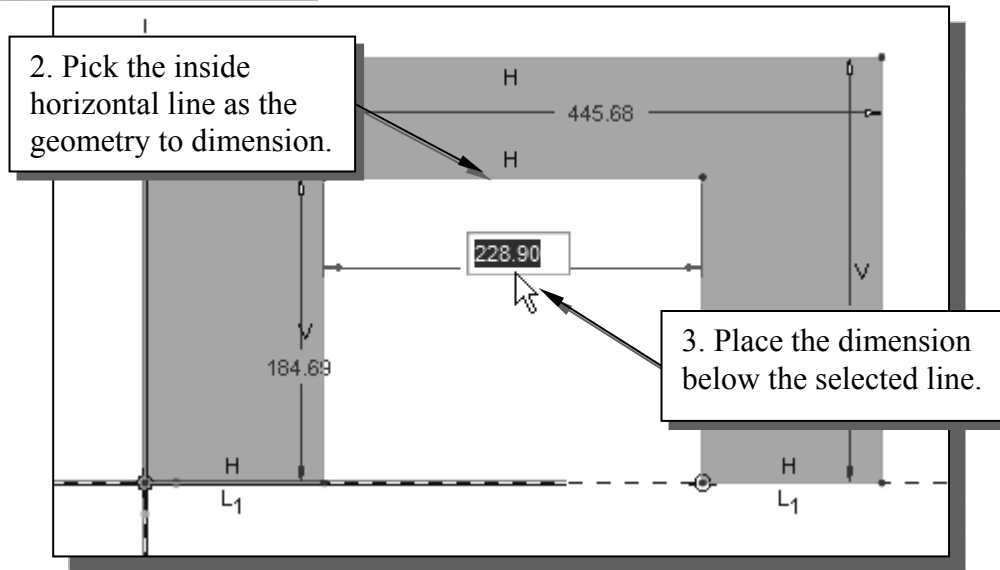

3. Move the graphics cursor below the selected line and click once with the **middle-mouse-button** to place the dimension. (Note that the value displayed on your screen might be different than what is shown in the above figure.)
4. Click again with the **middle-mouse-button** to exit the *Edit Dimension* mode.

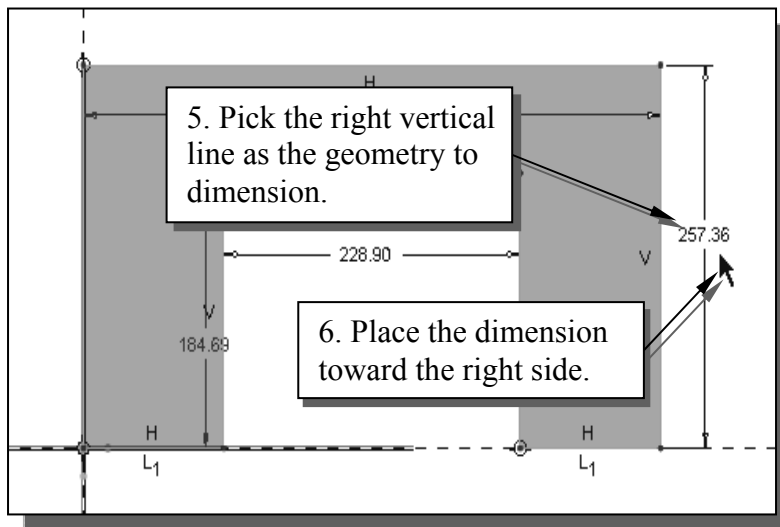

5. Select the **right vertical line**.
 6. Place the dimension, by clicking once with the **middle-mouse-button** at a location toward the right of the sketch.
- ❖ The **Dimension** command will create a length dimension if a single line is selected.

- Notice the overall-height dimension applied automatically by the *Intent Manager* is removed as the new dimension is defined.

❖ Note that the dimensions we just created are displayed with a different color than those that are applied automatically. The dimensions created by the *Intent Manager* are called **weak dimensions**, which can be replaced/deleted as we create specific defining dimensions to satisfy our design intent.

7. Select the **top horizontal line** as shown below.
8. Select the **inside horizontal line** as shown below.
9. Place the dimension, by clicking once with the **middle-mouse-button**, at a location in between the selected lines as shown below.

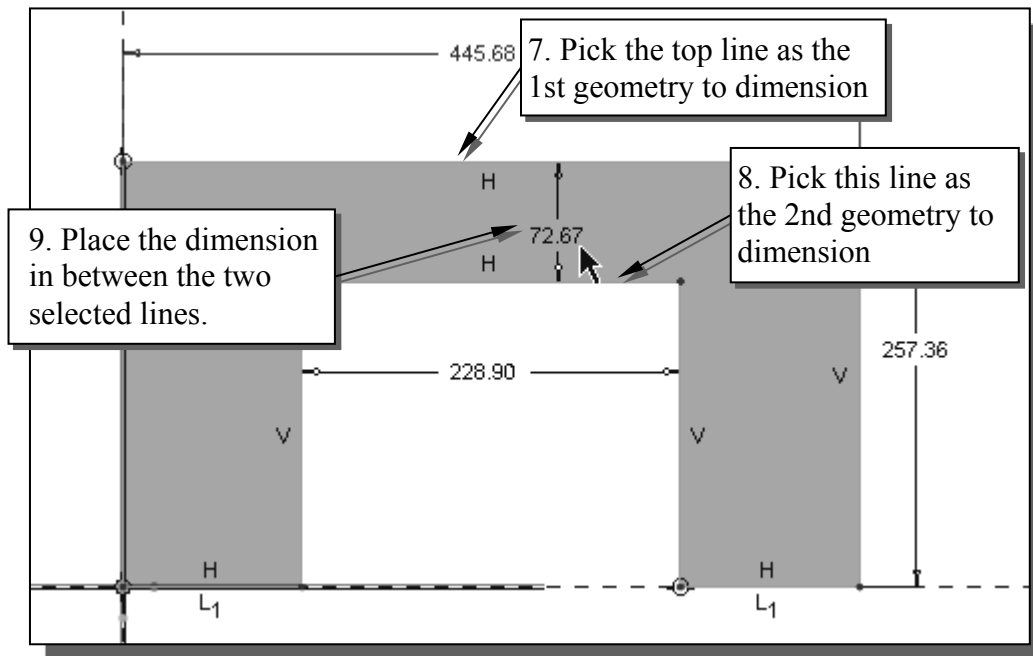

10. Click again with the **middle-mouse-button** to exit the *Edit Dimension* mode.

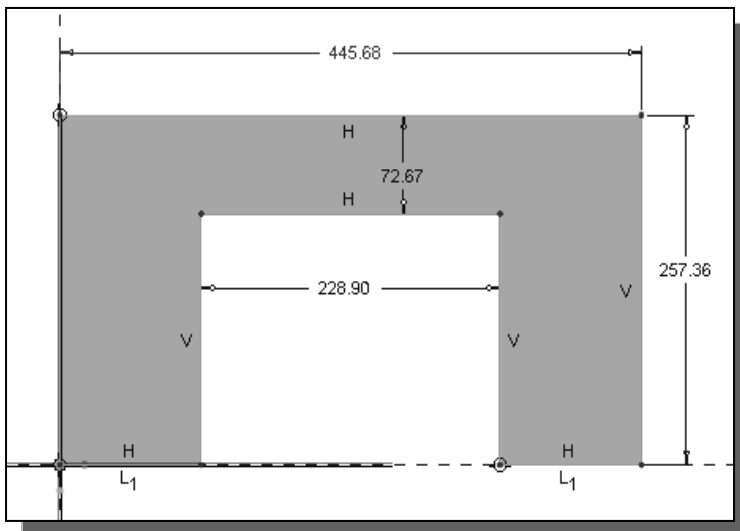

❖ When two parallel lines are selected, the **Dimension** command will create a dimension measuring the distance in between.

➤ Examine the established dimensions and constraints in the sketch. Is the sketch fully defined? Or should we add additional dimensions?

Modifying the Dimensions in a Sketch

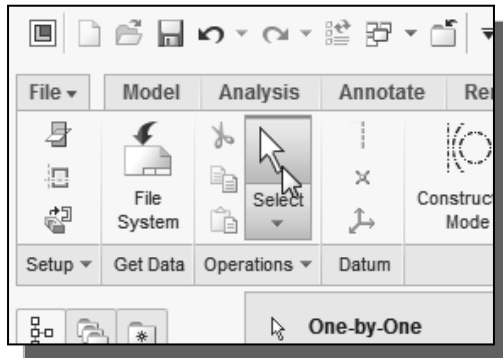

1. Click on the **Select** icon in the *Operations* toolbar as shown. The **Select** command allows us to perform several modification operations on the sketched geometry and dimensions.

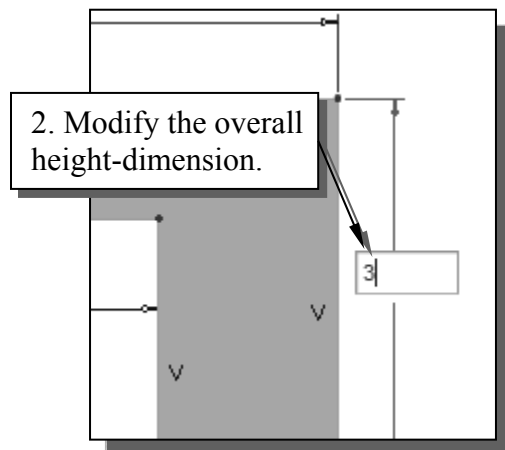

2. Select the overall height dimension of the sketch by **double-clicking** with the left-mouse-button on the dimension text.
3. In the *dimension value* box, the current length of the line is displayed. Enter **3** as the new value for the dimension.
4. Press the **ENTER** key once to accept the entered value.

- *Creo Parametric* will update the sketch using the entered dimension value. Since the other dimensions are much larger, the sketched shape becomes greatly distorted.

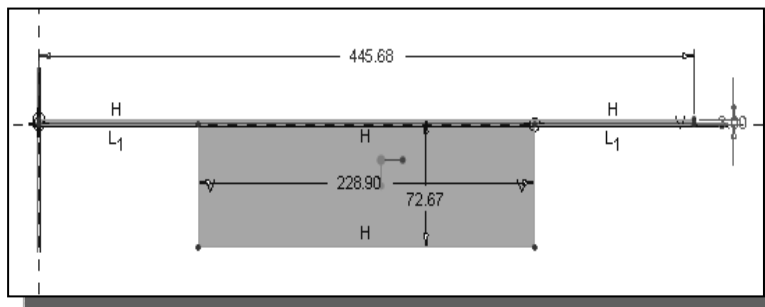

5. Click on the **Undo** icon in the *Quick Access* toolbar to undo the **Modify Dimension** performed.

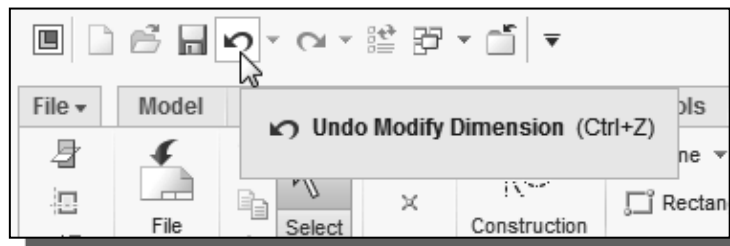

- Notice that the **Redo** icon is also available in the *Quick Access* toolbar.

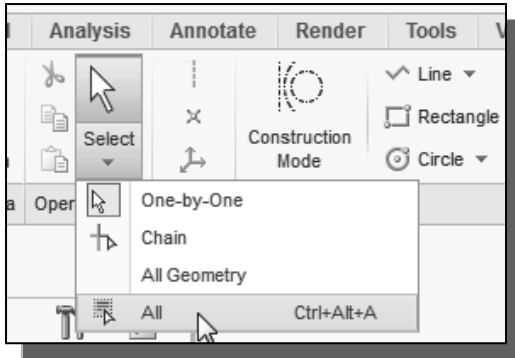

6. In the pull-down menu area, click on the down-arrow on **Select** to display the option list and select the **All** option as shown.

(Note that using the hotkey combination **Ctrl+Alt+A** can also activate this option.)

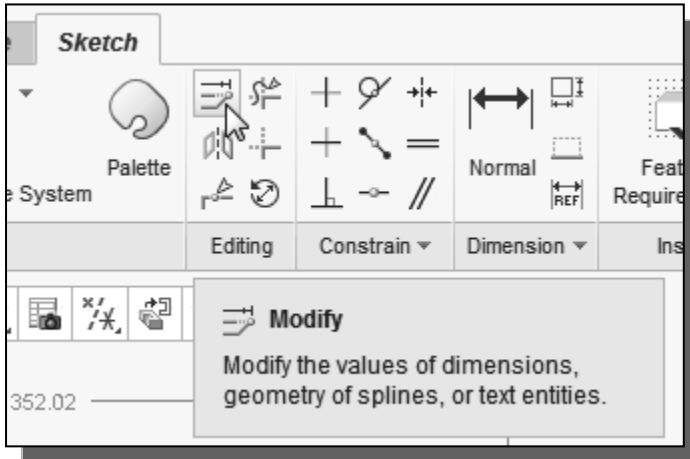

7. In the *Editing* toolbar, click on the **Modify** icon as shown.

- With the pre-selection option, all dimensions are selected and listed in the *Modify Dimensions* dialog box.
8. Turn *off* the **Regenerate** option by unchecking the option in the *Modify Dimensions* dialog box as shown.

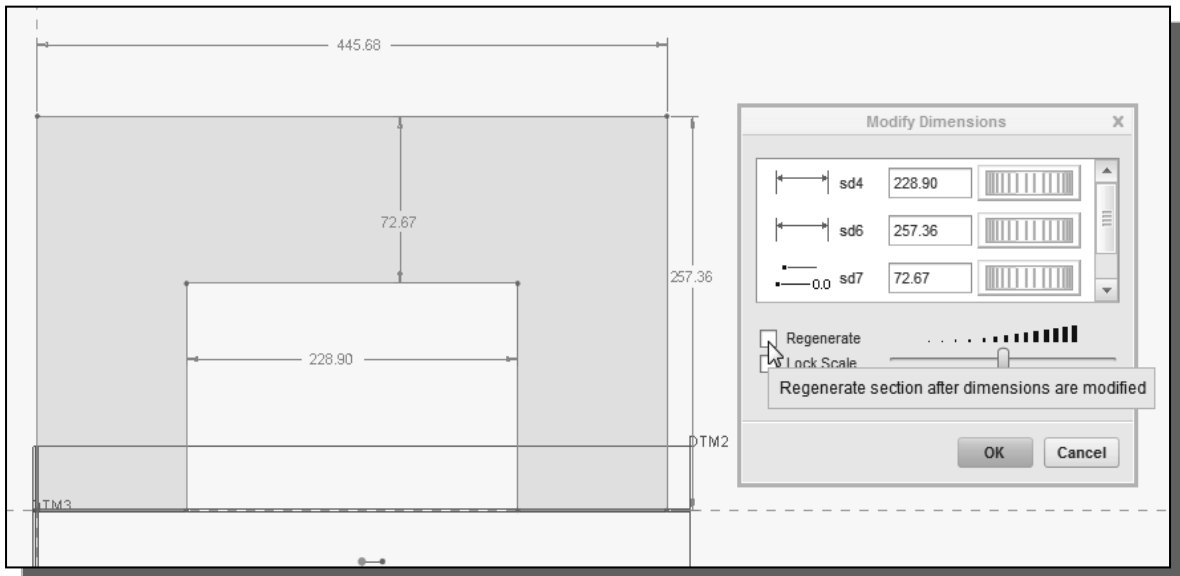

- On your own, adjust the dimensions as shown below. Note that the dimension selected in the *Modify Dimensions* dialog box is identified with an enclosed box in the display area.

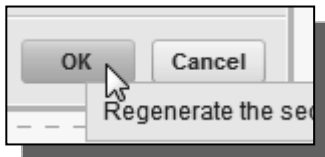
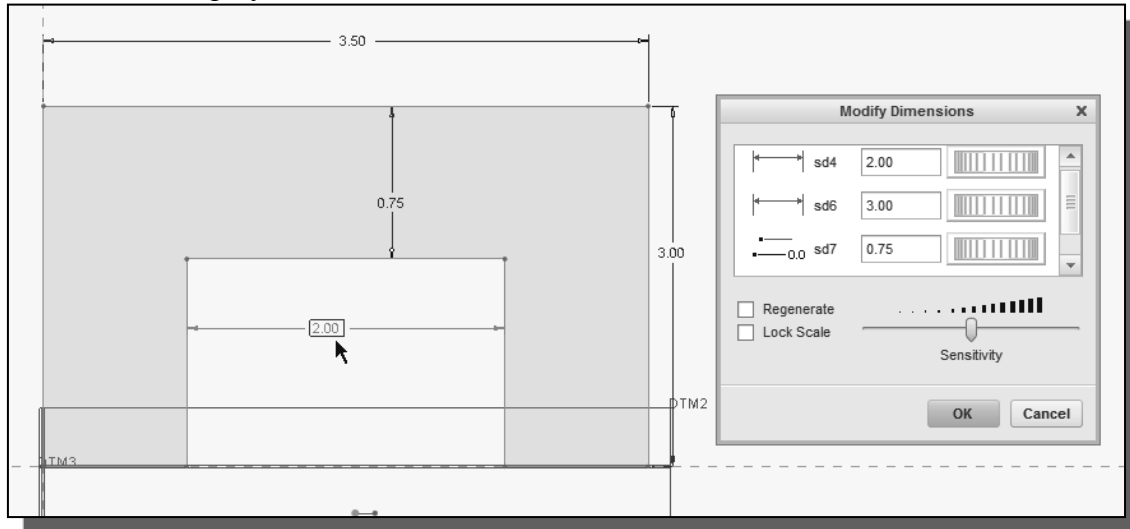

- Inside the *Modify Dimensions* dialog box, click on the **OK** button to regenerate the sketched geometry and exit the *Modify Dimensions* command.

Repositioning Dimensions

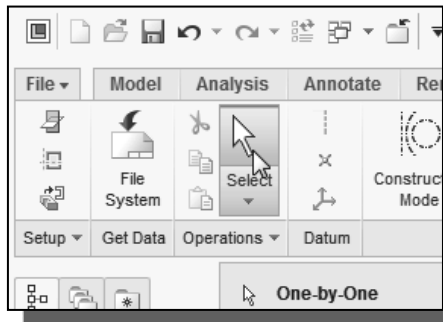

- Confirm the **Select** icon, in the *Operations* toolbar, is activated as shown.
- Press and hold down the **left-mouse-button** on any dimension text, then drag the dimension to a new location in the display area. (Note the cursor is changed to a moving arrow icon during this operation.)

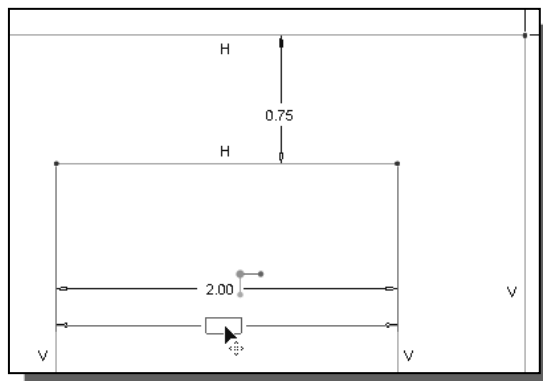
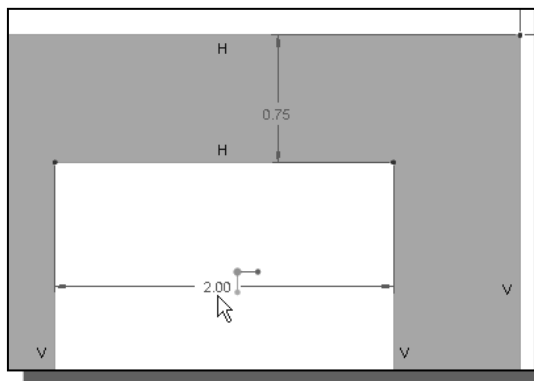

Step 5: Completing the Base Solid Feature

- ❖ Now that the 2D sketch is completed, we will proceed to the next step: creating a 3D part from the 2D section. Extruding a 2D section is one of the common methods that can be used to create 3D parts. We can extrude planar faces along a path. In *Creo Parametric*, the default extrusion direction is perpendicular to the selected sketching plane, DTM2.



1. In the *Ribbon* toolbar, click **OK** to exit the *Creo Parametric 2D Sketcher*. The 2D sketch is the first element of the *Extrude* feature definition.

2. In the *Feature Option Dashboard*, confirm the *depth value* option is set as shown. This option sets the extrusion of the section by **Extrude from sketch plane by a specified depth value**.

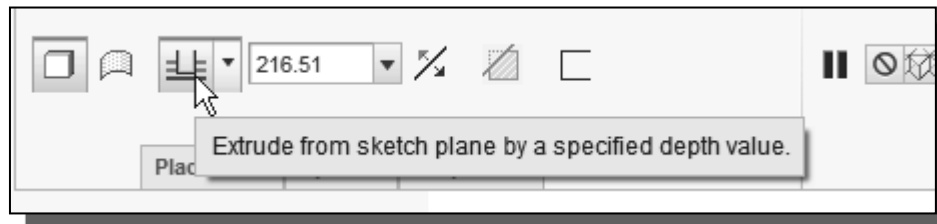

3. In the *depth value* box, enter **2.5** as the extrusion depth.

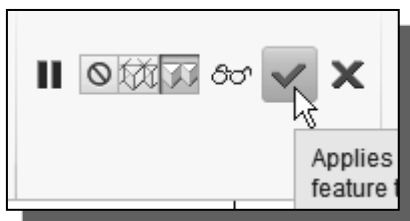
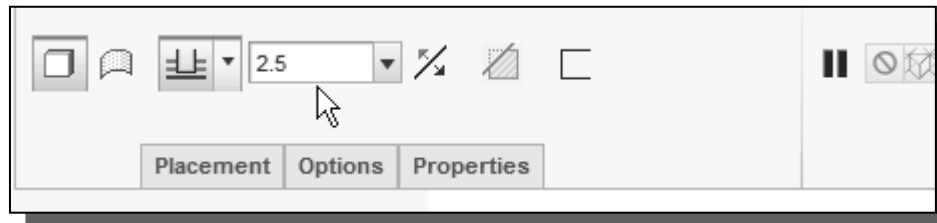

4. In the *Dashboard* area, click **Accept** to proceed with the creation of the solid feature.
5. Use the hotkey combination CTRL+D to reset the display to the default 3D orientation.

- Note that all dimensions disappeared from the screen. All parametric definitions are stored in the *Creo Parametric database*, and any of the parametric definitions can be displayed and edited at any time.

The Third Dynamic Viewing Function

3D Dynamic Rotation – [middle mouse button]

Press down the middle-mouse-button in the display area. Drag the mouse on the screen to rotate the model about the screen.

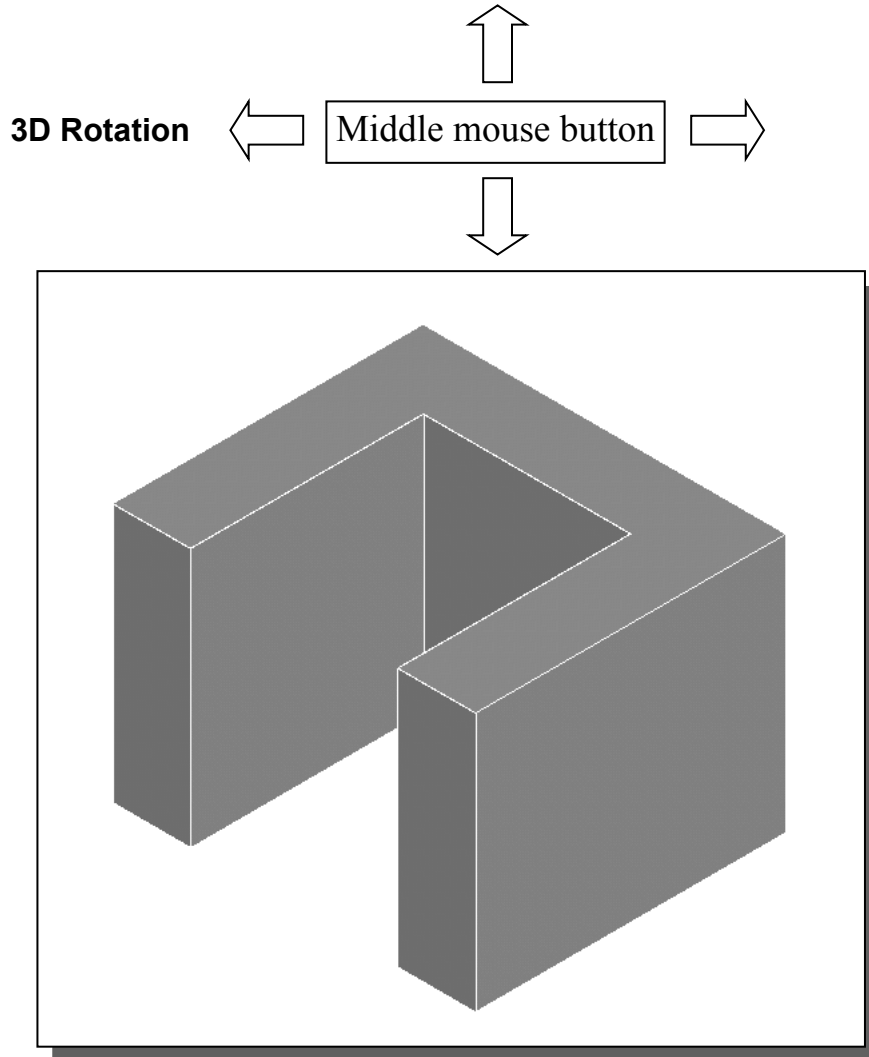

- ❖ On your own, practice the use of the *Dynamic Viewing functions*; note that these are convenient viewing functions at any time.

Zoom

Mouse Wheel

Zoom

Ctrl

+

Middle mouse button

Pan

Shift

+

Middle mouse button

Display Modes: Wireframe, Shaded, Hidden Edge, No Hidden

- The display in the graphics window has six display modes: Shading with Edges, Shading with Reflections, Shading, No Hidden lines, Hidden Line, and Wireframe image. To change the display mode in the active window, click on the display mode button in the *Display* toolbar to display the list as shown.

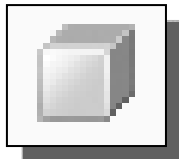
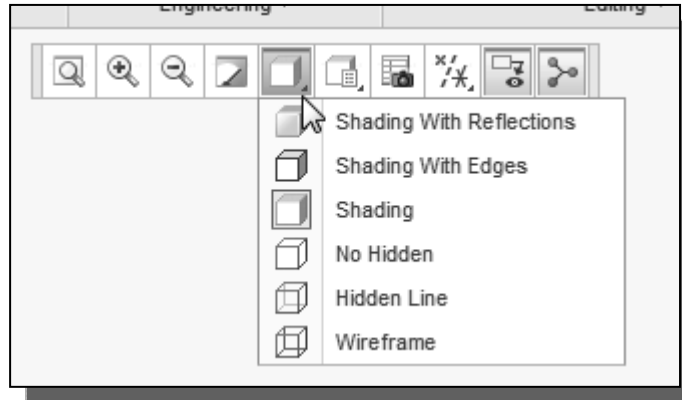

❖ **Shading With Reflections:**

The second icon in the display mode button group generates a more enhanced shaded image of the 3D object.

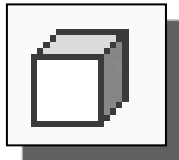

❖ **Shading With Edges:**

The first icon in the display mode button group generates a shaded image of the 3D object with edges highlighted.

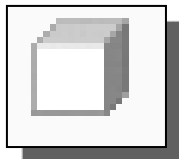

❖ **Shading:**

The third icon in the display mode button group generates a shaded image of the 3D object.



❖ **No Hidden:**

The fourth icon in the display mode button group can be used to generate a wireframe image of the 3D object with all the back lines removed.

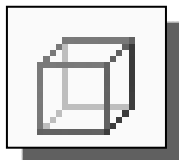

❖ **Hidden Line:**

The fifth icon in the display mode button group can be used to generate a wireframe image of the 3D object with all the back lines shown as hidden lines.

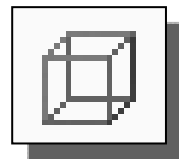

❖ **Wireframe:**

The sixth icon in the display mode button group allows the display of 3D objects using the basic wireframe representation scheme.

Step 6: Adding Additional Features

- Next, we will create another extrusion feature that will be added to the existing solid object.

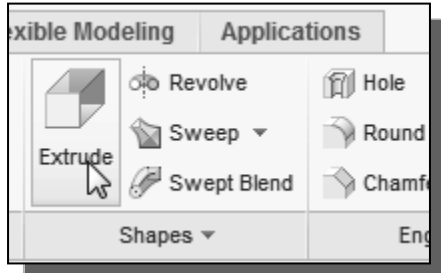

- In the **Shapes** toolbar (the fourth toolbar in the *Ribbon* toolbar), select the **Extrude** tool option as shown.

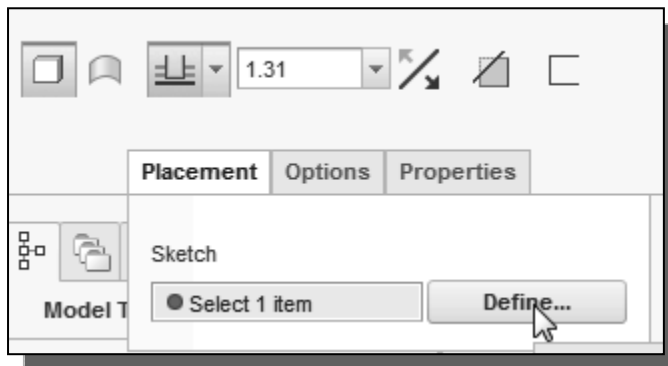

- Click the **Placement** option and choose **Define** to begin creating a new *internal sketch*.

- Pick the right vertical face of the solid model as the sketching plane as shown in the figure below.

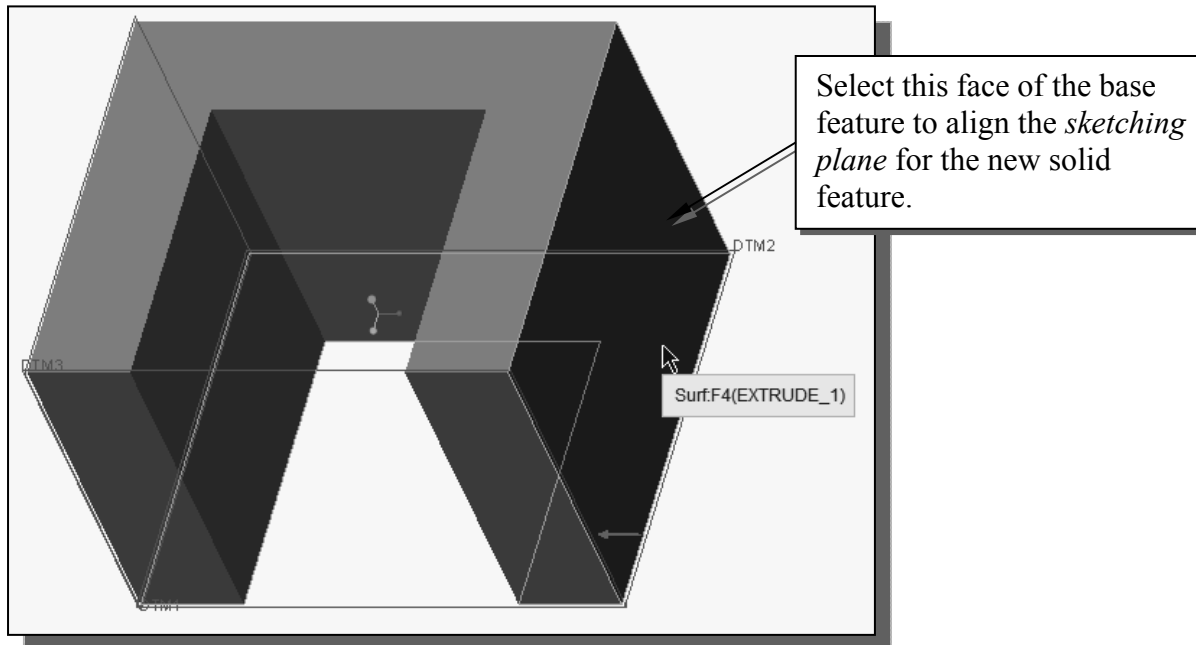

- On your own, confirm the viewing direction is set as shown in the figure above.

- In the display area, pick the **top face** of the base feature as the reference plane as shown.

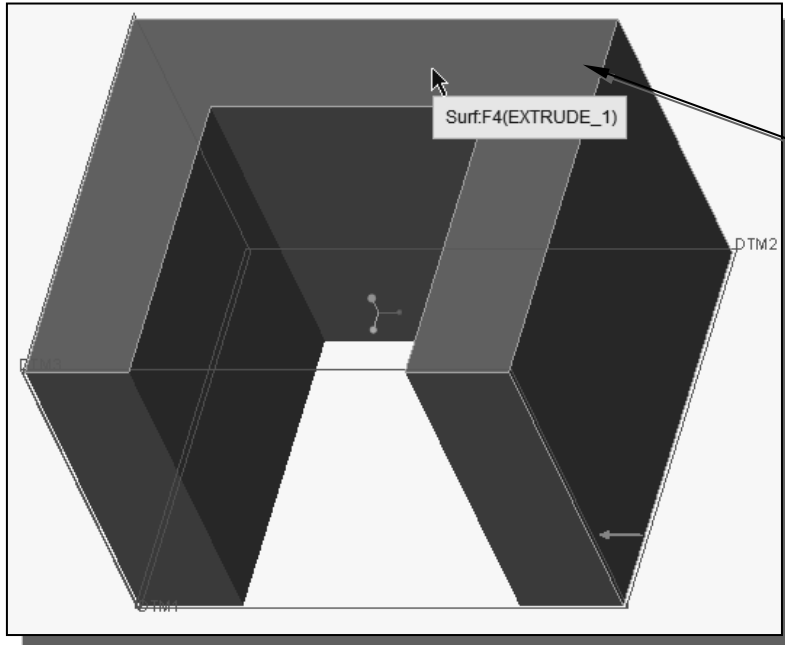

Select the top face of the base feature as the *reference plane* to set the orientation of the sketch plane.

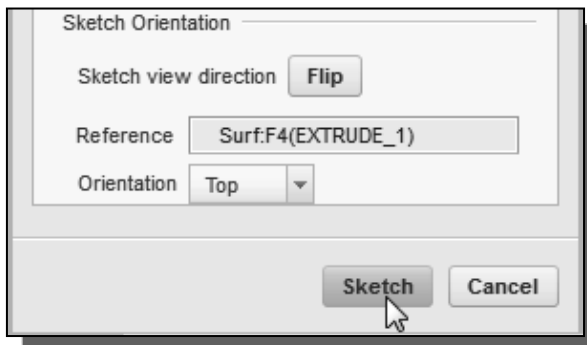

- In the Sketch Orientation menu, pick **Top** to set the reference plane Orientation.

- Pick **Sketch** to exit the *Section Placement* window and proceed to enter the *Creo Parametric Sketcher* mode.

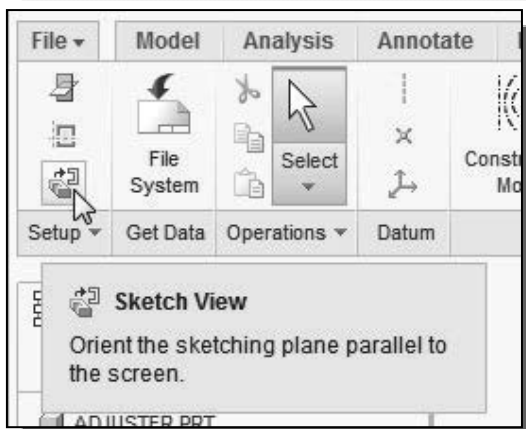

- To orient the sketching plane parallel to the screen, click on the **Sketch View** icon in the *Setup* toolbar as shown.

- Note that the top surface of the solid model and one of the datum planes are pre-selected as the sketching references to aid the positioning of the sketched geometry. In the graphics area, the two references are highlighted and displayed with two dashed lines.

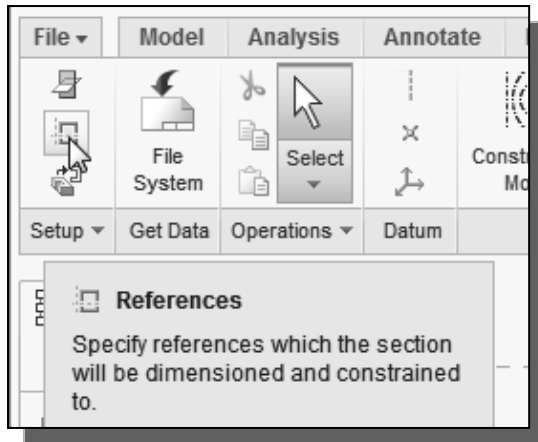

10. In the *Setup* toolbar, click on **References** to display the option list and select the **References** option.

➤ This will bring up the *References* dialog box.

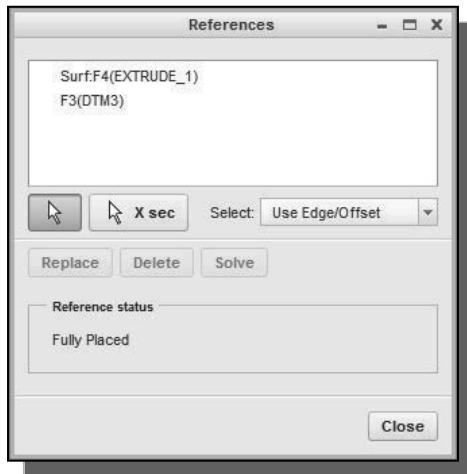

➤ Note that, in the *References* dialog box, the top surface of the solid model and DTM3 are pre-selected as the sketching references as shown.

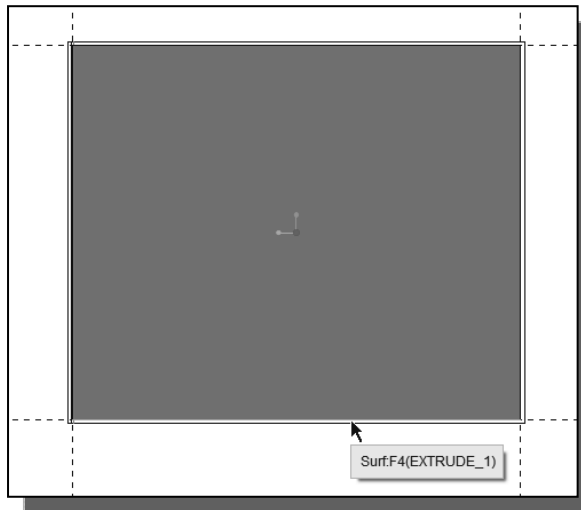

11. Select the **right edge** and the bottom edge of the base feature so that the four sides of the selected sketching plane, or corresponding datum planes, are used as references as shown.

12. Click **Solve** to apply the changes.

13. In the *References* dialog box, click on the **Close** button to accept the selections.



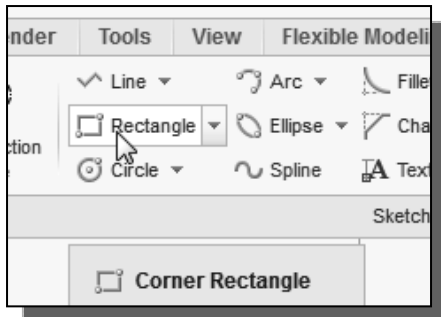

14. In the *Sketching* toolbar, click on the **Corner Rectangle** icon as shown to activate the Rectangle command.

15. Create a rectangle by clicking on the **lower left corner** of the solid model as shown below.
16. Move the cursor upward and place the opposite corner of the rectangle along the **right edge** of the base solid as shown below.

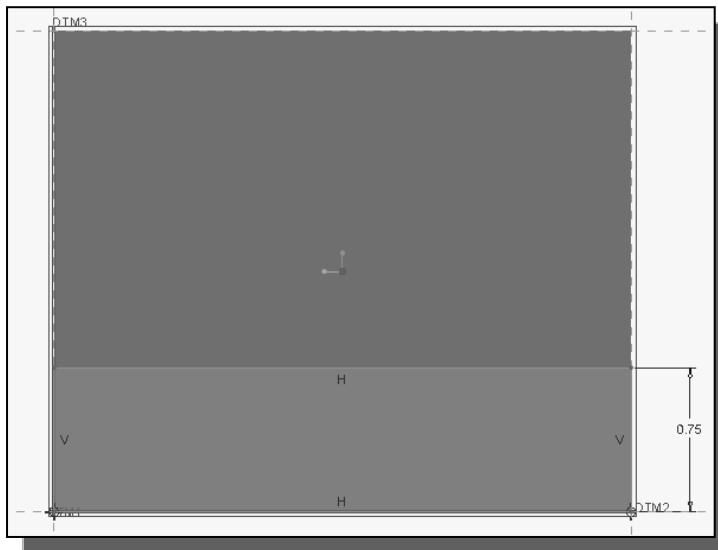
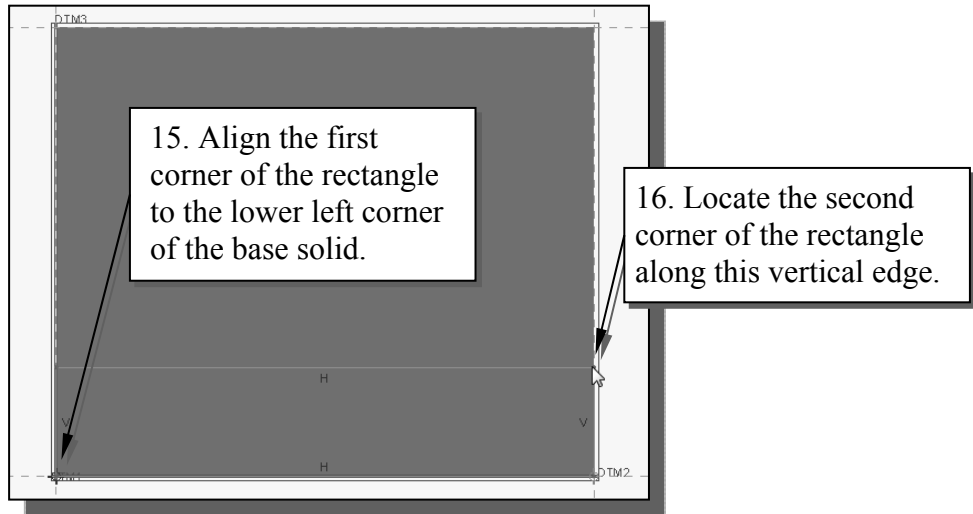

17. On your own, modify the height dimension to **0.75** as shown.

- Note that only one dimension, the height dimension, is applied to the 2D sketch; the width of the rectangle is defined by the references.

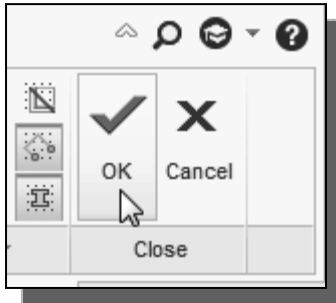

18. In the *Ribbon* toolbar, click on the **OK** icon to end the *Creo Parametric 2D Sketcher* and proceed to the next element of the feature definition.

19. In the *Feature Option Dashboard*, confirm the *depth value* option is set and enter **2.5** as the extrusion depth as shown.

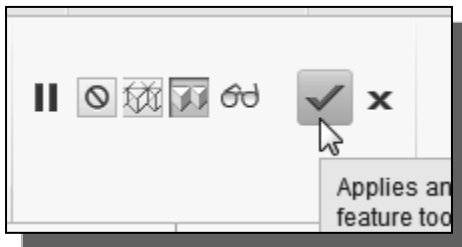
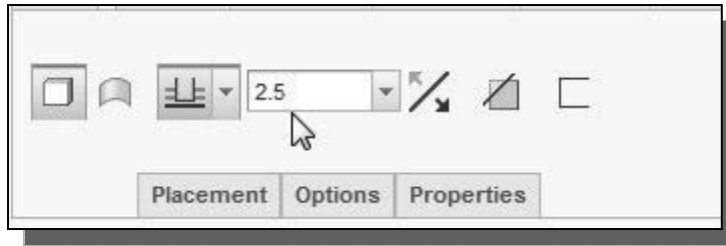

20. In the *dashboard* area, click **Accept** to proceed with the creation of the solid feature.

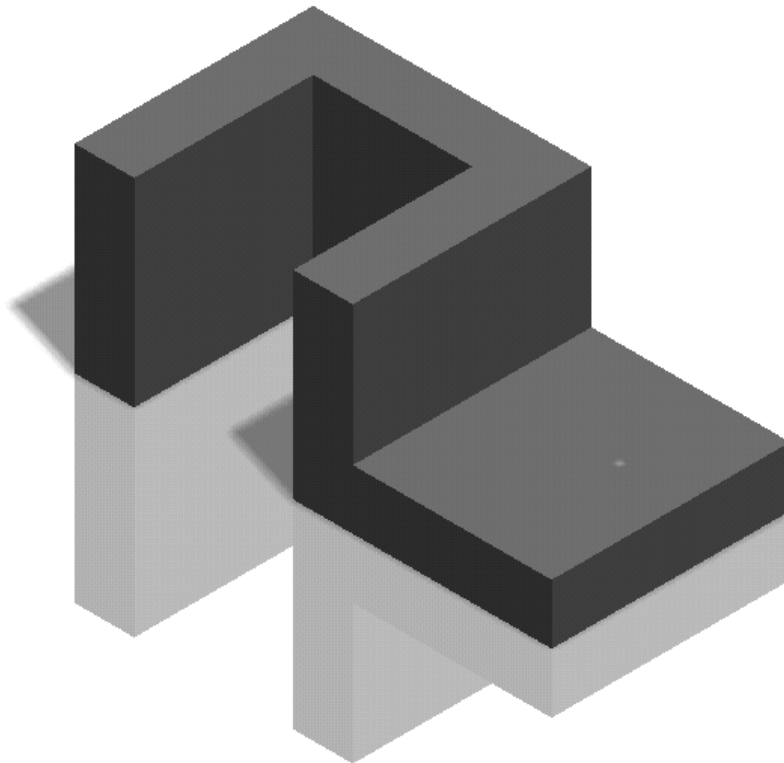

Creating a CUT Feature

- ❖ We will create a circular cut as the next solid feature of the design. Note that the procedure in creating a *cut feature* is almost the same as creating a *protrusion feature*.

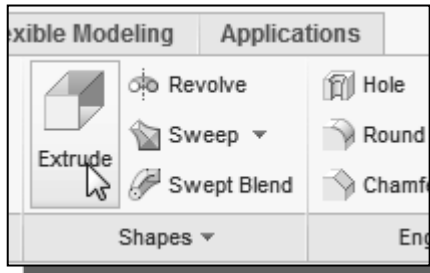

1. In the *Shapes* toolbar (the fourth toolbar in the *Ribbon* toolbar area), select the **Extrude** tool option as shown.

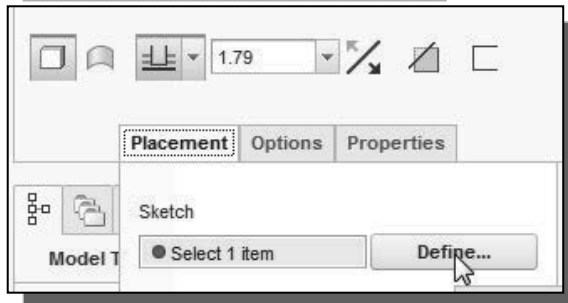

2. Click the **Placement** option and choose **Define** to begin creating a new *internal sketch*.

3. We will use the top surface of the last feature as the sketching plane. Click once, with the **left-mouse-button**, inside the top surface of the rectangular solid feature as shown in the figure below.

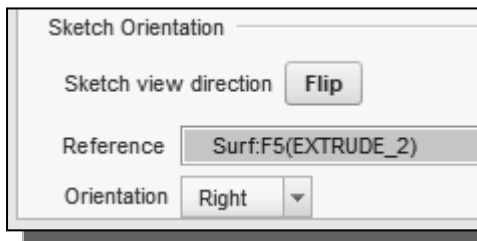

4. In the *Sketch Orientation* menu, confirm the reference plane Orientation is set to **Right**.
5. Pick the **right vertical face** of the second solid feature as the reference plane, which will be oriented toward the right edge of the computer screen.

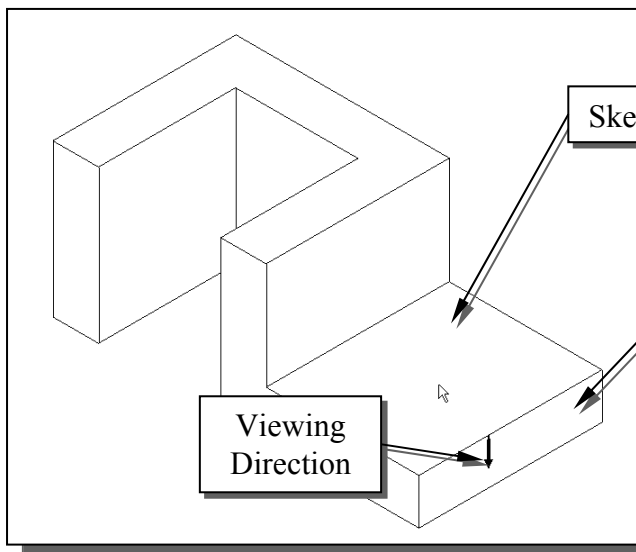

Orient this **reference plane** to face the **right** edge of the computer screen.

6. Click **Sketch** to exit the *Sketch* dialog window and proceed to enter the *Creo Parametric Sketcher* mode.

Creating the 2D Section of the CUT Feature



1. Note that the **right vertical plane** is pre-selected as a reference for the new sketch.
- Note that at least one horizontal reference and one vertical reference are required to position a 2D sketch. We will need at least one more vertical reference for this sketch.

2. Select **DTM3** as the vertical sketching references as shown. In the graphics area, the two references are highlighted and displayed with two dashed lines.

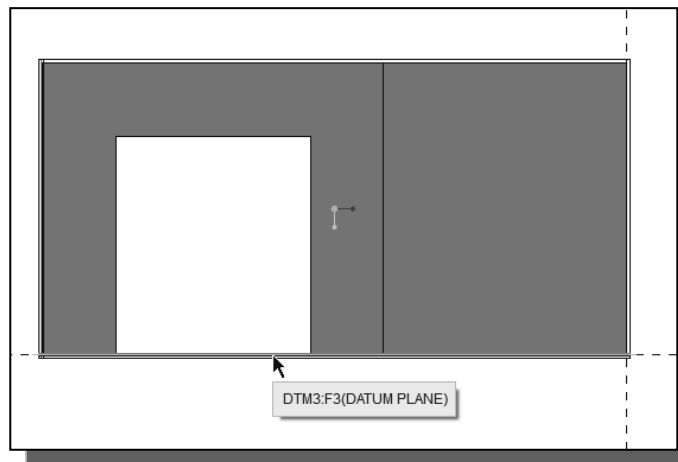

3. Click **Solve** to apply the changes.
4. Click on the **Close** button to accept the selected references and proceed to entering the *Creo Parametric Sketcher* module.

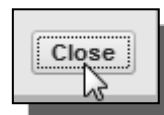

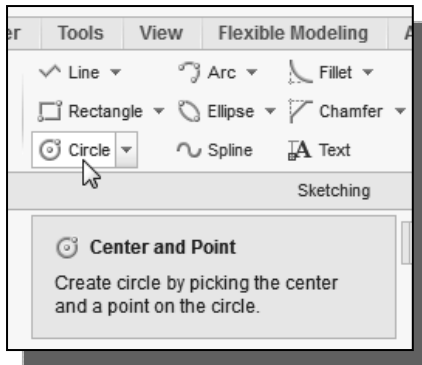

- In the *Sketching* toolbar, select **Circle** as shown. The default option is to create a circle by specifying the center point and a point through which the circle will pass. The message “*Select the center of a circle*” is displayed in the message area.

- On your own, create a circle of arbitrary size on the sketching plane as shown.

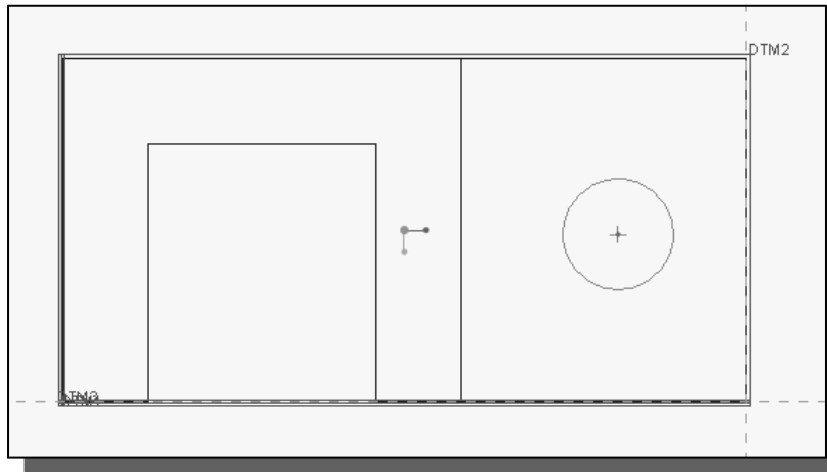

- On your own, edit/modify the dimensions as shown.

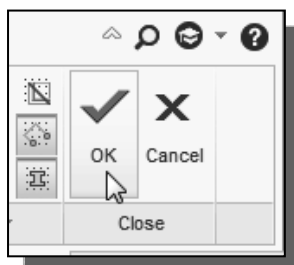
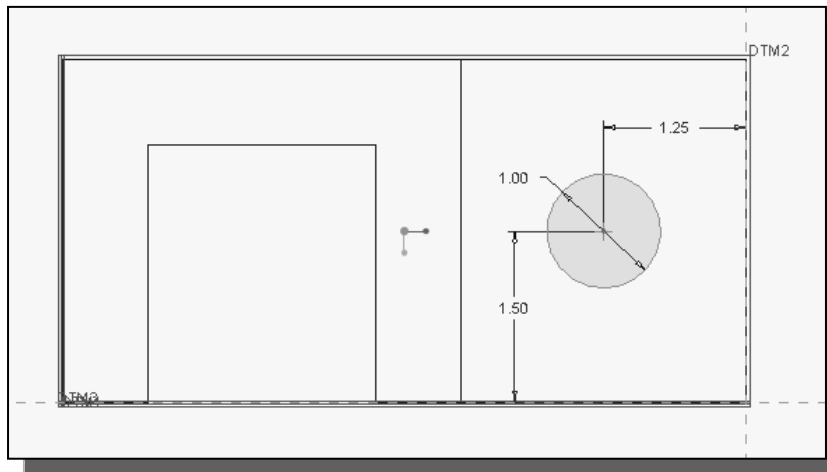

- In the *Ribbon* toolbar, click **OK** to exit the *Creo Parametric 2D Sketcher* and proceed to the next element of the feature definition.

9. Switch on the **Remove Material** option as shown in the figure below.

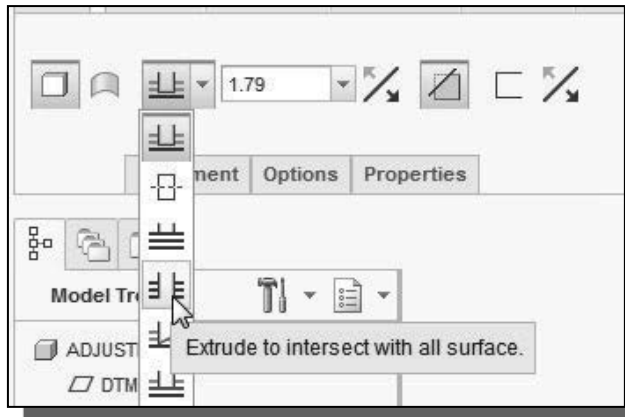
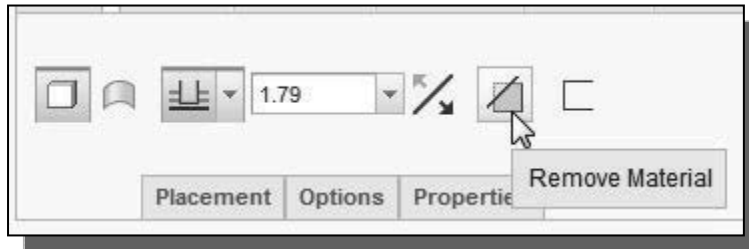

10. In the *Feature Option Dashboard*, select the **Extrude to intersect with all surface** option as shown.

- Note that this **Thru All** option does not require us to enter a value to define the depth of the extrusion; *Creo Parametric* will calculate the required value to assure the extrusion is through the entire solid model.

11. On your own, use the *Dynamic Rotate* function to view the feature.

12. Click on the **Flip direction** icon as shown in the figure below to set the cut direction.

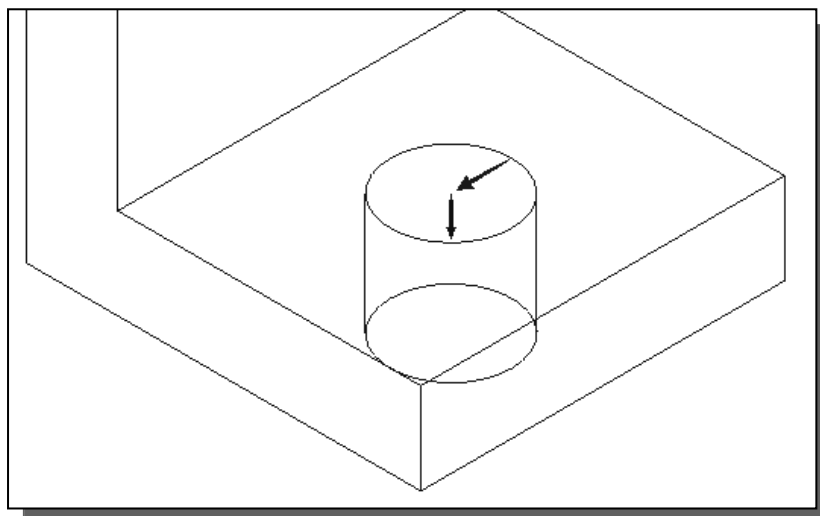
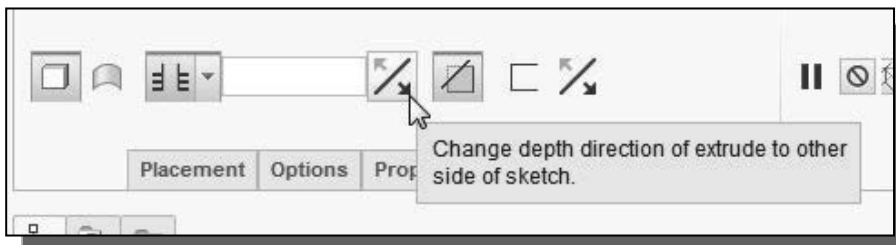

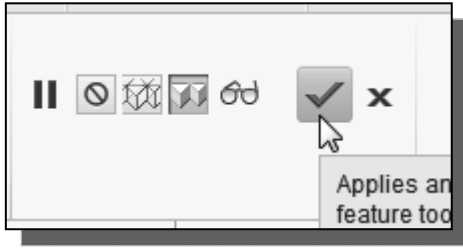

13. Click on **Accept** to proceed with the extrusion option.

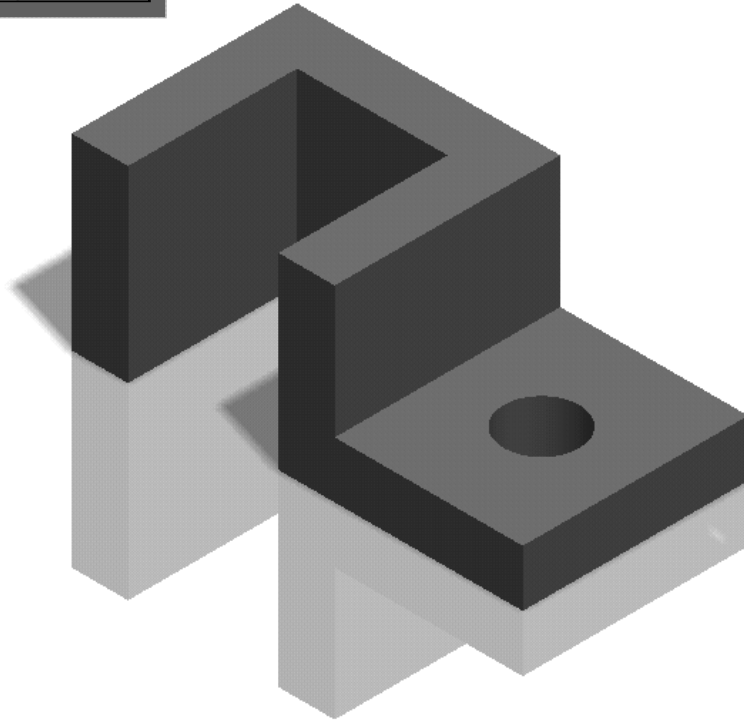

Creating another CUT Feature

❖ We will next create a triangular cut as the next solid feature of the design.

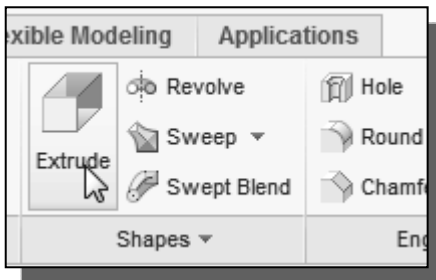

1. In the *Shapes* toolbar (the fourth toolbar in the *Ribbon* toolbar area), select the **Extrude** tool option as shown.

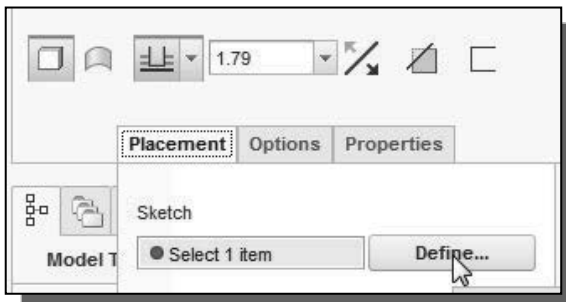

2. Click the **Placement** option and choose **Define** to begin creating a new *internal sketch*.

- We will use the right vertical surface of the first solid feature as the sketching plane. Click once, with the **left-mouse-button**, inside the top surface of the rectangular solid feature as shown in the figure below.

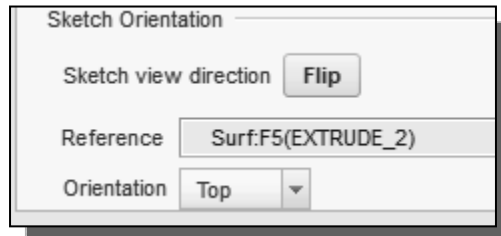

- In the Sketch Orientation menu, set the reference plane Orientation to **top**.
- Pick the **top horizontal face** of the second solid feature as the reference plane, which will be oriented toward the top edge of the computer screen.

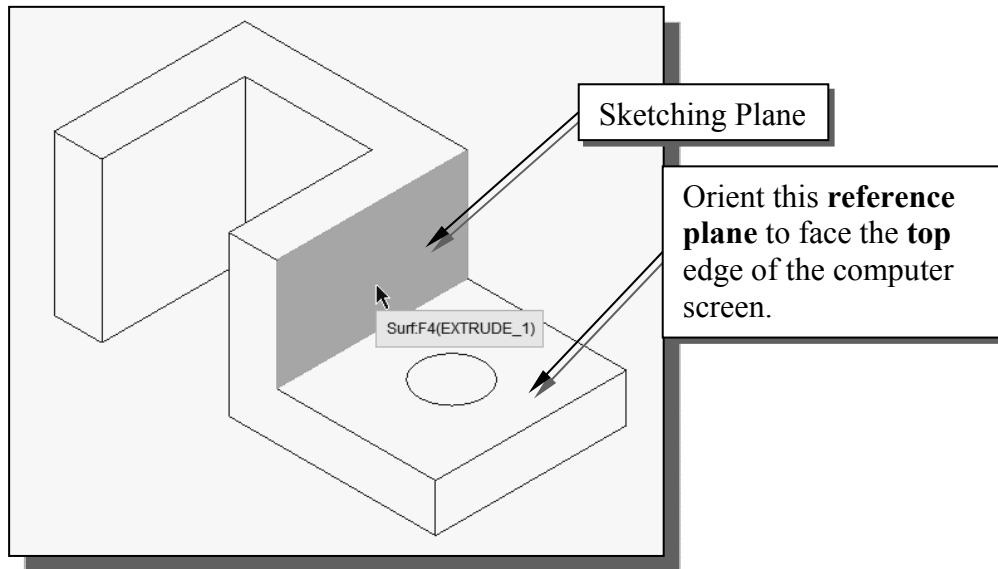

- Click **Sketch** to exit the *Sketch* dialog window and proceed to enter the *Creo Parametric Sketcher* mode.

Delete/Select the Sketching References



- Note that currently the **top horizontal plane** of the second solid feature is pre-selected as a reference for the new sketch.
 - Note that at least one horizontal reference and one vertical reference are required to position a 2D sketch. We will need at least one more vertical reference for this sketch.

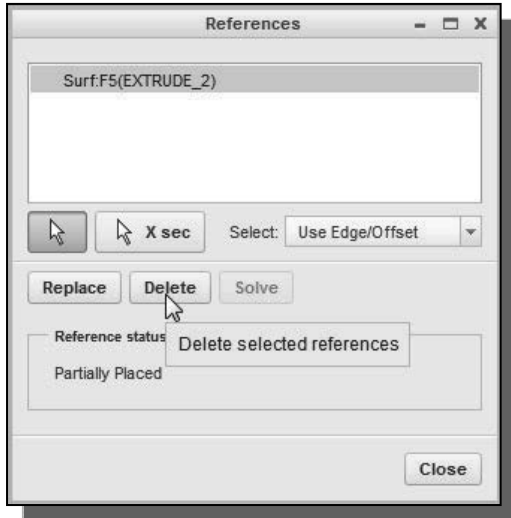

2. Select the **referenced surface** in the item list.
3. Click **Delete** to remove the item as a reference plane.

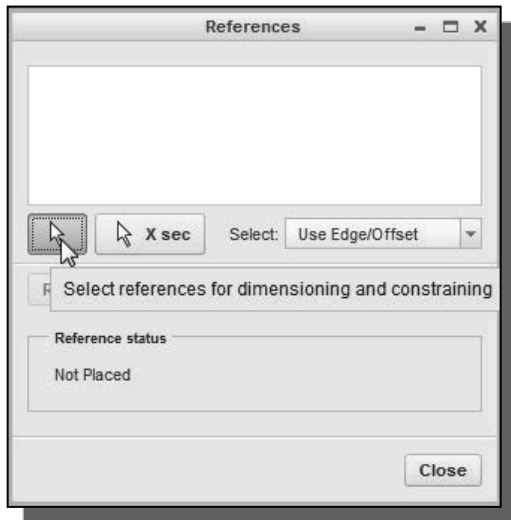

4. Click on the **Select Reference** button to activate select command.
5. Select the left vertical edge, **DTM3**, and the top surface as sketching references as shown. In the graphics area, the two references are highlighted and displayed with two dashed lines.

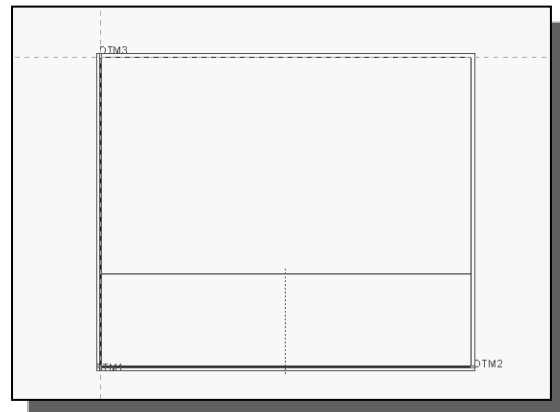

6. Click **Solve** to apply the changes.
7. Click on the **Close** button to accept the selected references and proceed to entering the *Creo Parametric Sketcher* module.



Create the 2D Section

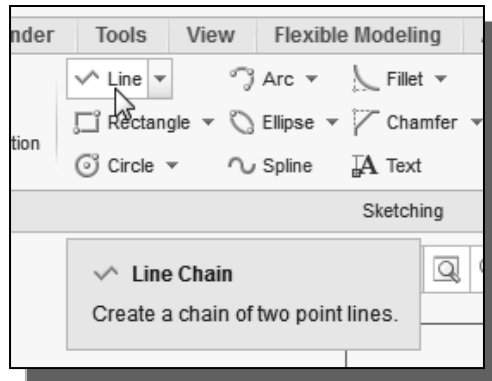

1. In the *Sketching* toolbar, select **Line** as shown. The default option is to create a chain of lines by specifying the endpoint of the line segments.

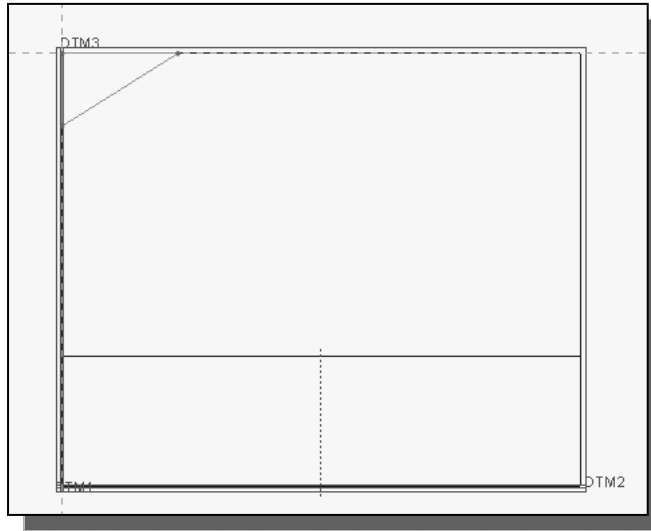

2. On your own, starting at the top left corner and create a triangle of arbitrary size on the sketching plane as shown.

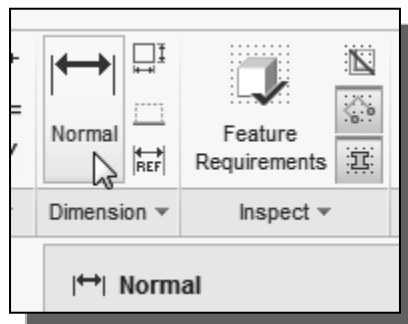

3. On your own, edit/modify the length dimension of the top edge of the triangle as shown.

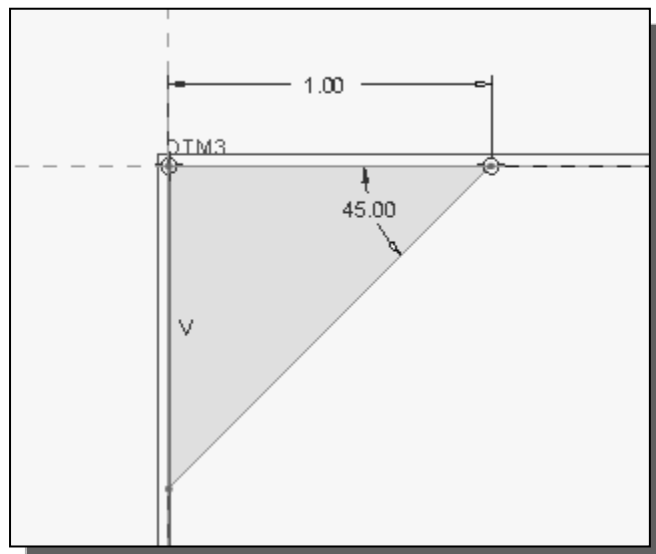

4. Create the angle dimension by selecting the two adjacent lines and place the angular dimension *inside* the desired quadrant.

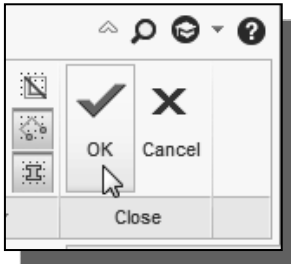

5. In the *Ribbon* toolbar, click **OK** to exit the *Creo Parametric 2D Sketcher* and proceed to the next element of the feature definition.

6. Switch on the **Remove Material** option as shown in the figure below.

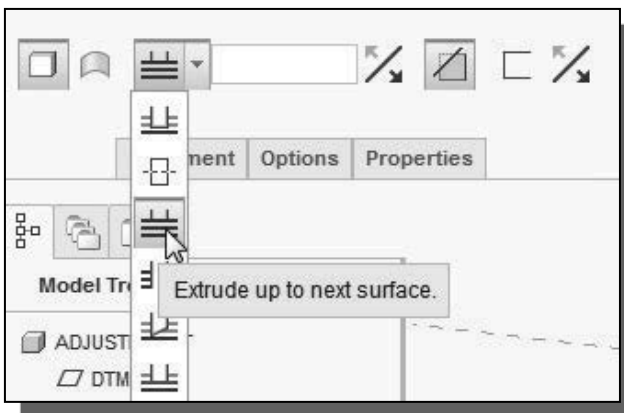
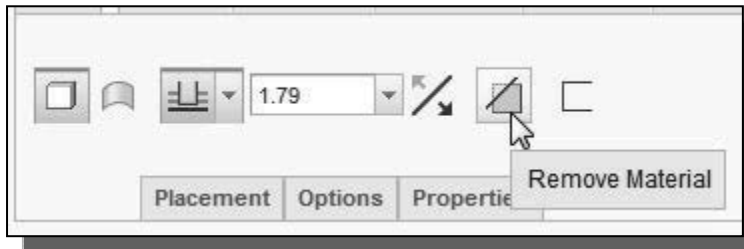

7. In the *Feature Option Dashboard*, select the **Extrude to Next surface** option as shown.

- Note that with the **Extrude to Next surface** option; *Creo Parametric* will calculate the required value to assure the extrusion is to the next surface.

8. Click on the **Flip direction** icon as shown in the figure below to set the cut direction.

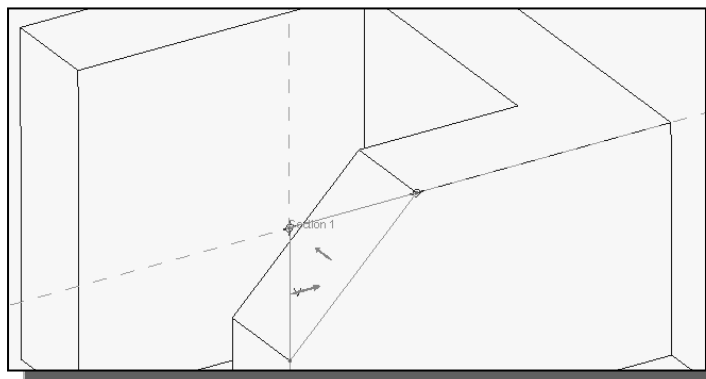
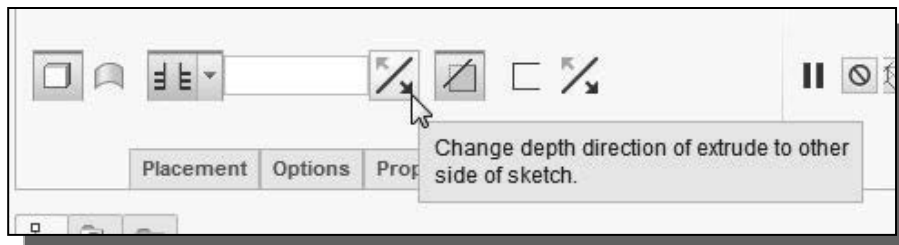

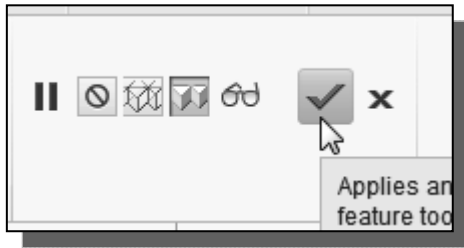

- Click on **Accept** to proceed with the extrusion option.

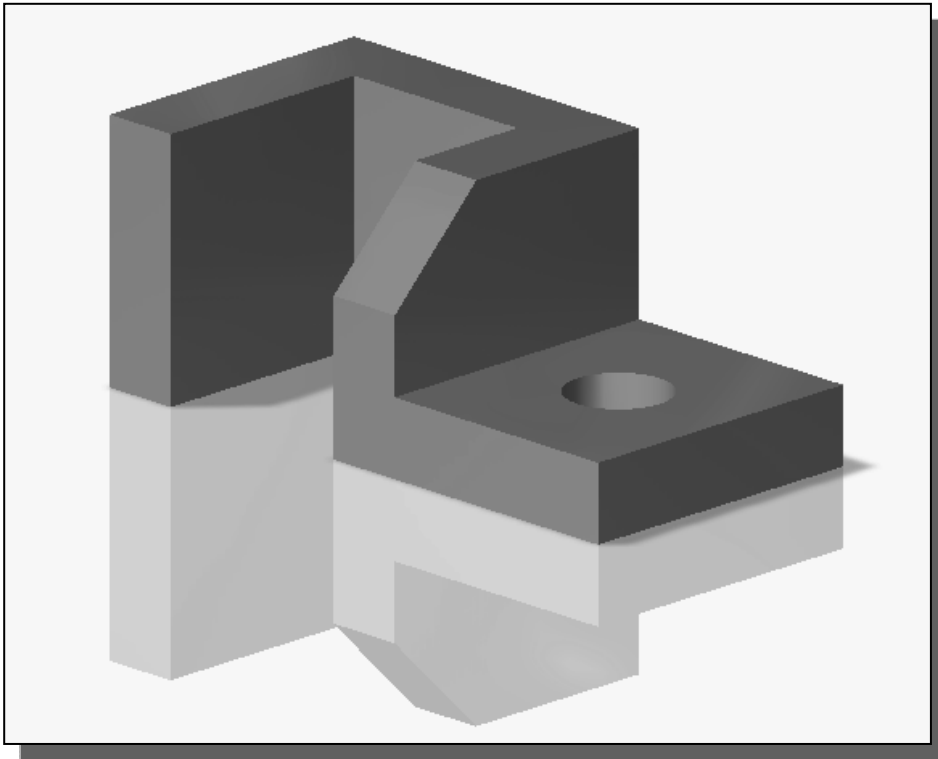

Save the Part

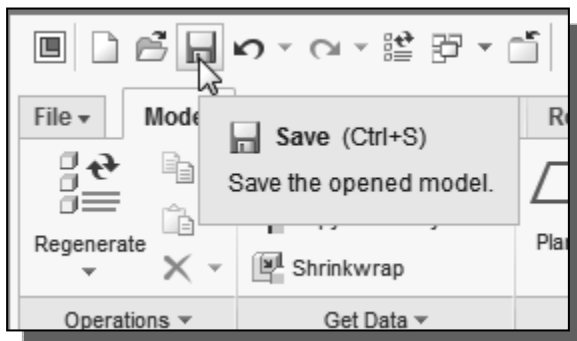

- Select **Save** in the *Standard* toolbar, or you can also use the “**Ctrl-S**” combination (press down the **[Ctrl]** key and hit the **[S]** key once) to save the part.

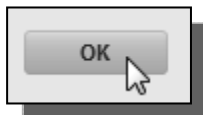

- In the *message area*, the part name is displayed. Click on the **OK** button to save the file.

- ❖ It is a good habit to save your model periodically. In general, you should save your work onto the disk at an interval of every 15 to 20 minutes.

Review Questions:

1. What is the first thing we should set up in *Creo Parametric* when creating a new model?
2. How do we modify more than one dimension in the *Sketcher*?
3. How do we reposition dimensions in the *Sketcher*?
4. List three of the geometric constraint symbols used by the *Creo Parametric Sketcher*.
5. Describe two different ways to modify dimensions in the *Sketcher*.
6. Describe the steps required to define the orientation of the sketching plane?
7. Identify the following quick-keys commands:

(a)

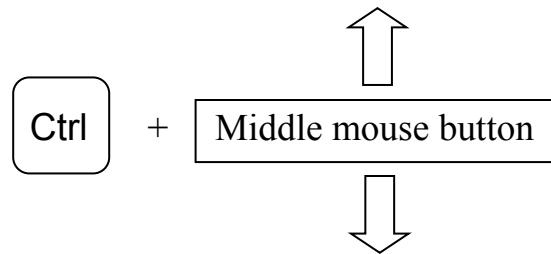

(b)

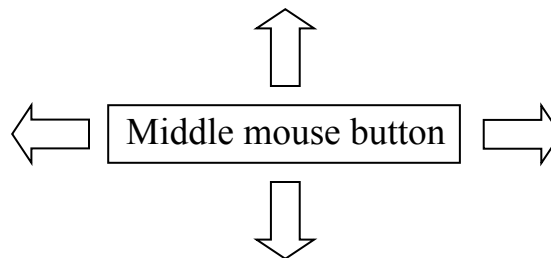

Exercises: (All dimensions are in inches.)

1. Angle Spacer (Plate Thickness: 0.25)

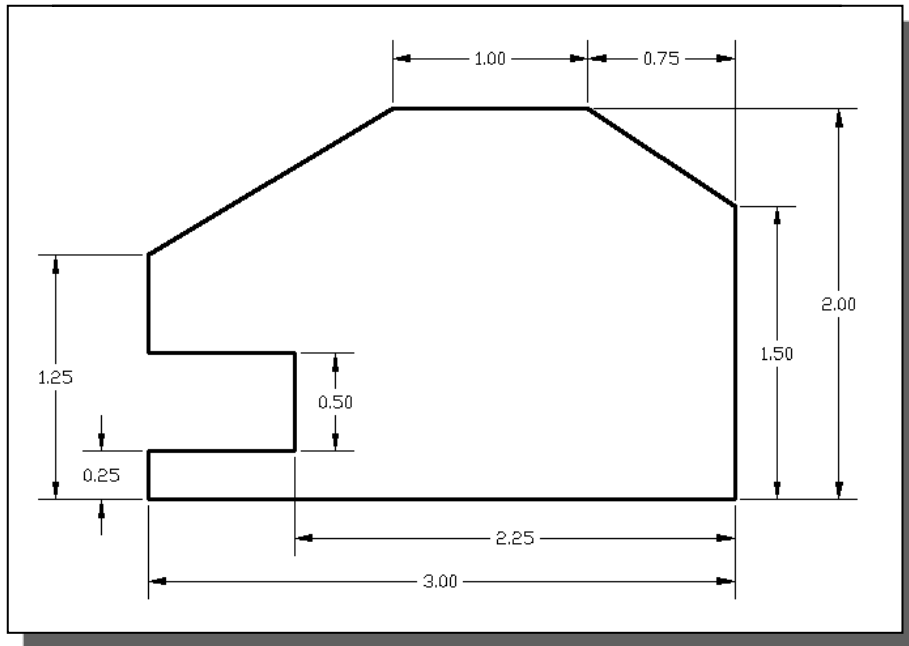

2. Spacer Plate (Plate Thickness: 0.125)

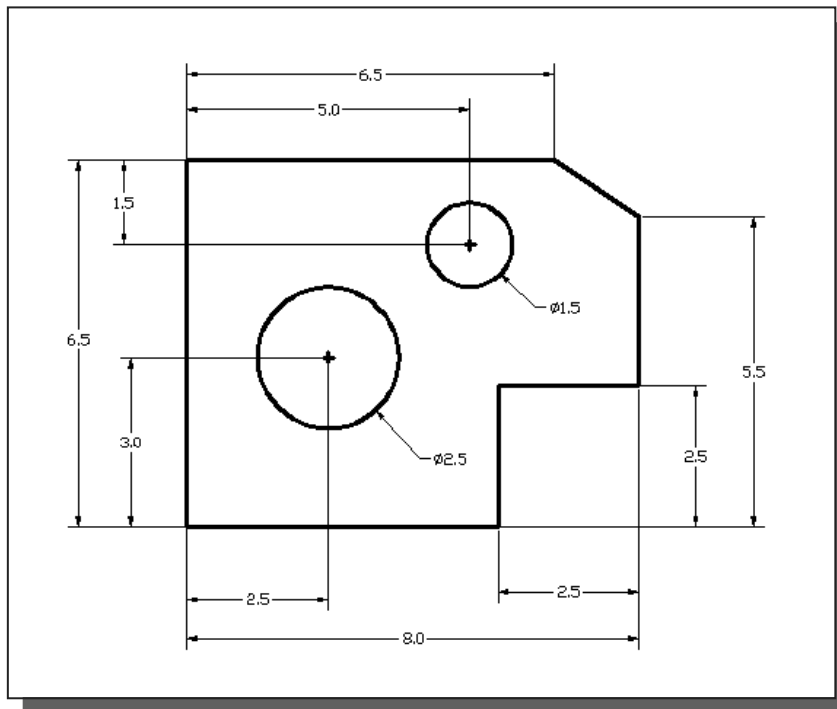

3. Positioning Stop

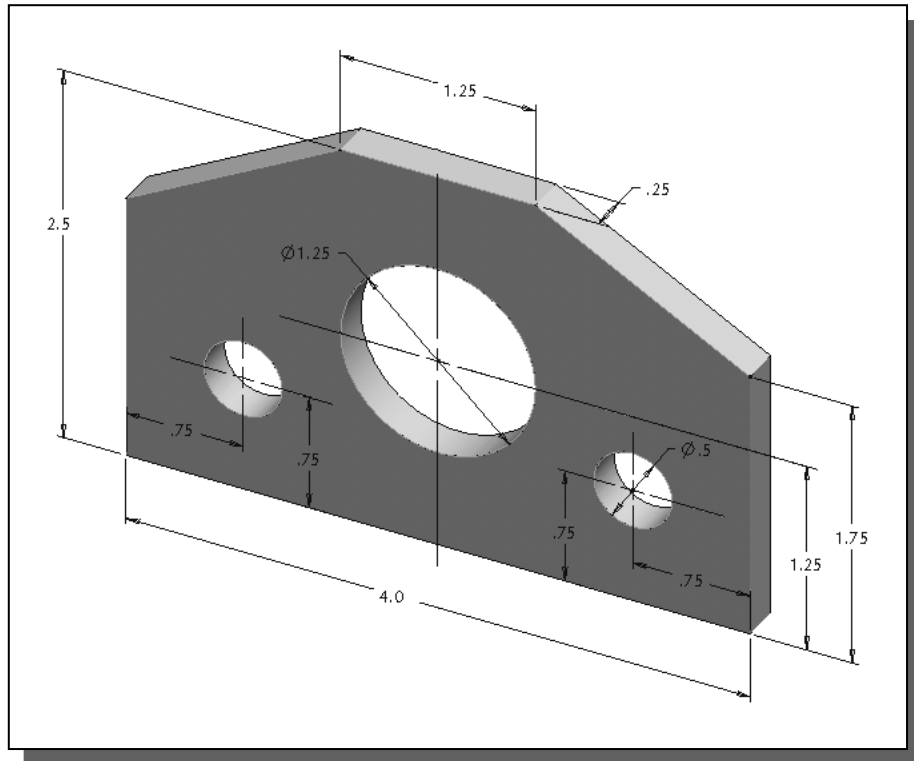

4. Guide Block

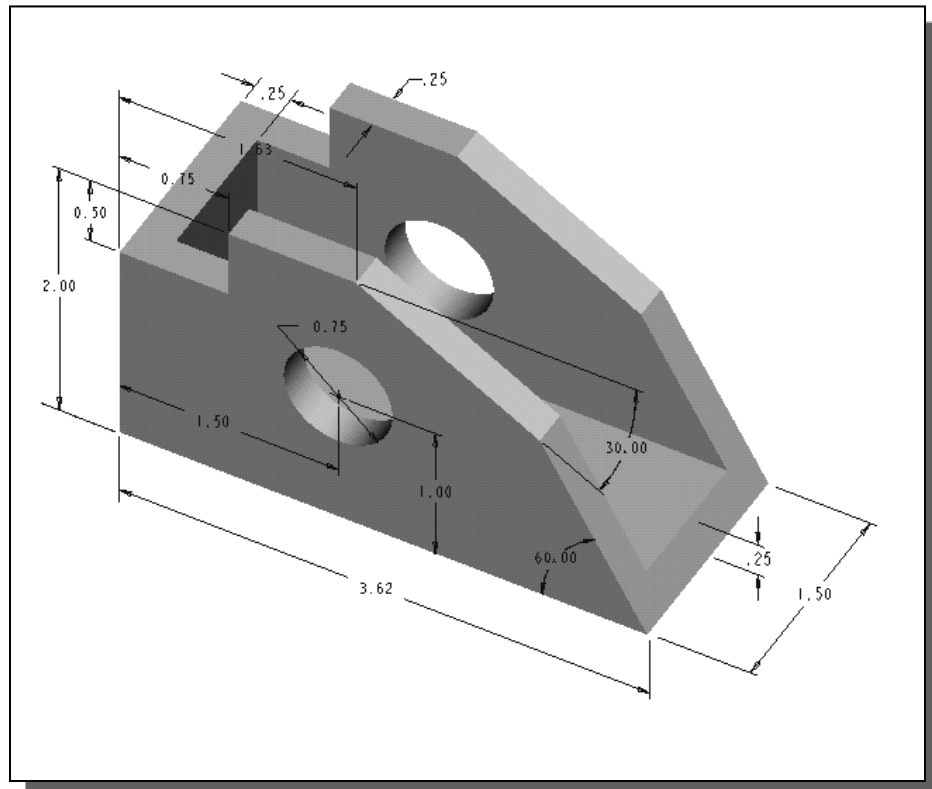

Notes: