

Autodesk® **Inventor 2016** **Essentials Plus**

Daniel T. Banach & Travis Jones

NEW
Features a chapter
on sheet metal design

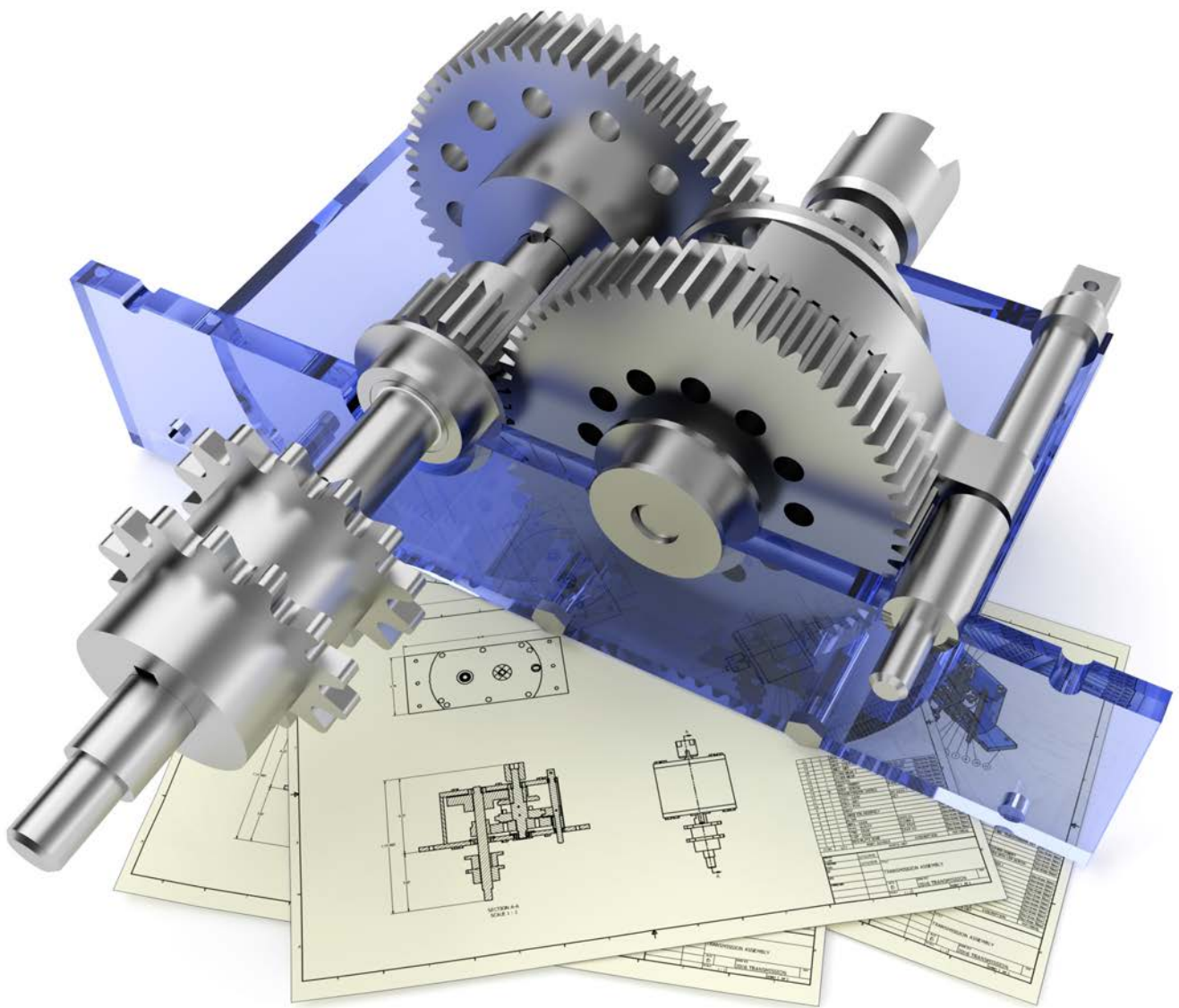

Visit the following websites to learn more about this book:



[amazon.com](https://www.amazon.com)

[Google books](https://books.google.com)

[BARNES & NOBLE](https://www.barnesandnoble.com)

Chapter 2 – Sketching, Constraining, and Dimensioning

INTRODUCTION

Most 3D parts in Autodesk Inventor start from a 2D sketch. This chapter first provides a look at the application options for creating a part file and sketching. It then covers the three steps in creating a 2D parametric sketch: sketching a rough 2D outline of a part, applying geometric constraints, and then adding parametric dimensions. Lastly, you learn how to use 2D AutoCAD data in a sketch.

OBJECTIVES

After completing this chapter, you will be able to do the following:

- Change the part and sketch Application Options to meet your needs
- Sketch an outline of a part
- Create geometric constraints to a sketch to control design intent
- Use construction geometry to help constrain a sketch
- Dimension a sketch
- Change a dimension's value in a sketch
- Insert AutoCAD DWG data into a part's sketch

PART AND SKETCH APPLICATION OPTIONS

Before you start a new part, examine the part and sketch options in Autodesk Inventor that will affect how the part file will be created and how the sketching environment will look and act. While learning Autodesk Inventor, refer back to these option settings to determine which ones work best for you—there are no right or wrong settings.

Part Options

You can customize Autodesk Inventor Part options to your preferences. Click the Inventor Application Menu > Options button, and click on the Part tab, as shown in the following image. Descriptions of a couple of the most common Part options follow. For more information about the Application Options consult the help system. These settings are global—they will affect all active and new Autodesk Inventor documents.

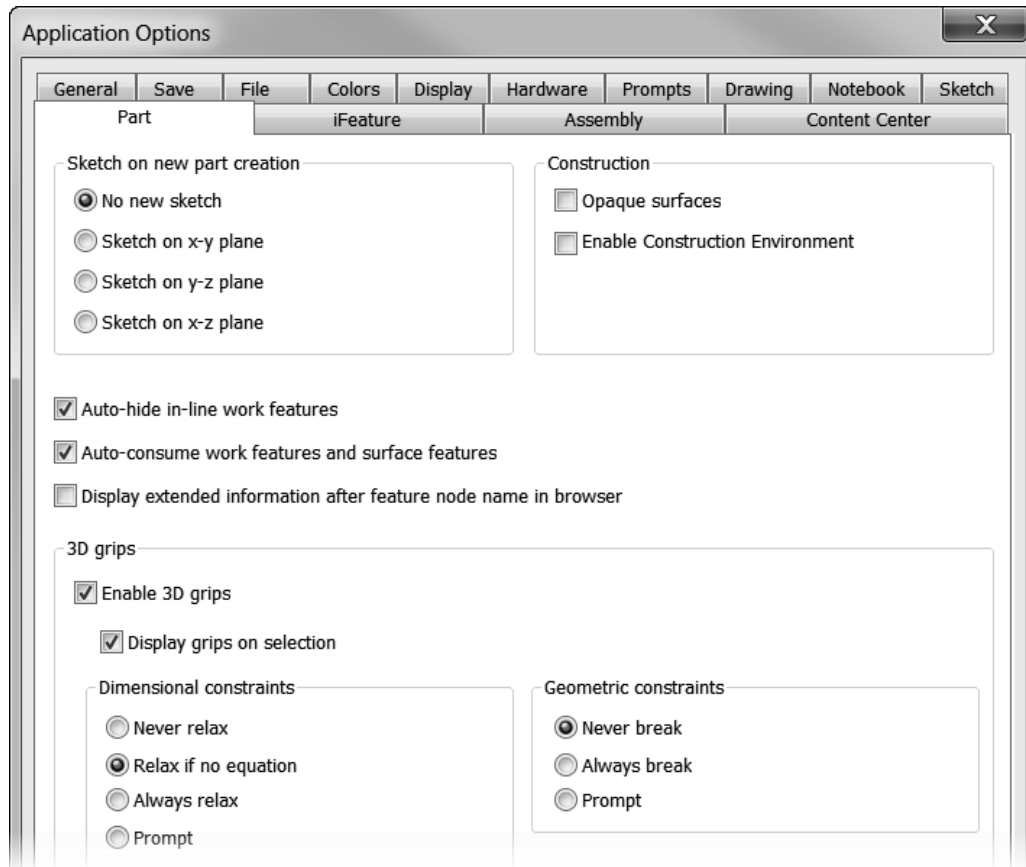

Figure 2-1

A common option that you may want to change is the first option; Sketch on New Part Creation. This option controls if and how a sketch is created when a part file is created.

No new sketch

When checked, Inventor does not set a sketch plane when you create a new part (this is the default setting).

Sketch on x-y plane

When checked, Inventor sets the x-y plane as the current sketch plane when you create a new part.

Sketch on y-z plane

When checked, Inventor sets the y-z plane as the current sketch plane when you create a new part.

Sketch on x-z plane

When checked, Inventor sets the x-z plane as the current sketch plane when you create a new part.

Sketch Options

Autodesk Inventor sketching options can be customized to your preferences. Click Inventor Application Menu > Options, and then click on the Sketch tab as shown in the following image. Descriptions of the most common Sketch options follow. For more information about the Application Options consult the help system. These settings are global, and all of them affect currently active Autodesk documents and Autodesk Inventor documents you open in the future.

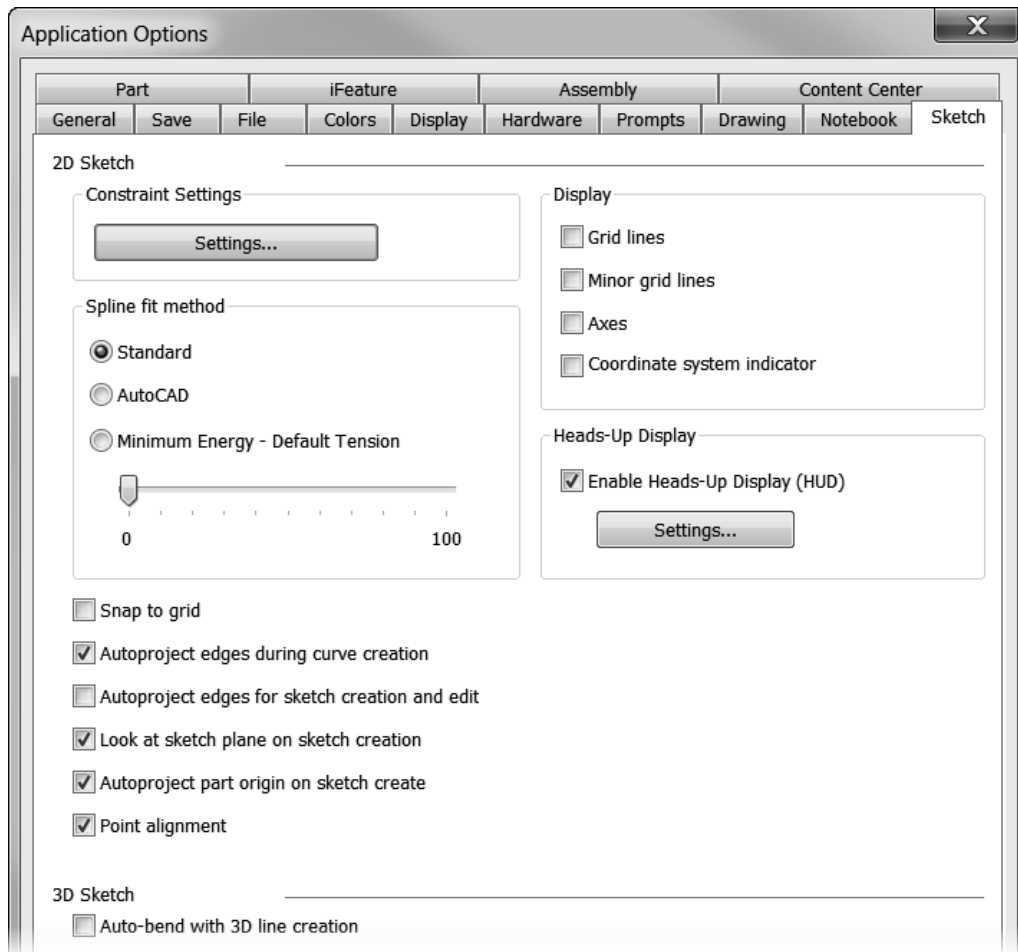

Figure 2-2

Following are descriptions of the common settings that you may want to change.

Constraint Settings

Click the Settings button to control how sketch constraints and dimensions behave.

Display

Grid lines

Toggles both minor and major grid lines on the screen on and off. To set the grid distance, click the Tools tab > Options panel > Document Settings command, and on the Sketch tab of the Document Settings dialog box, change the Snap Spacing and Grid Display.

Minor grid lines

Toggles the minor grid lines displayed on the screen on and off.

Axes

Toggles the lines that represent the X and Y-axis of the current sketch on and off.

Coordinate system indicator

Toggles the icon on and off that represents the X-, Y-, and Z-axes at the 0, 0, 0 coordinates of the current sketch.

Snap to Grid

When checked, endpoints of sketched objects snap to the intersections of the grid as the cursor moves over them.

Autoproject edges during curve creation

When checked, and while sketching, place the cursor over an object and it will be projected onto the current sketch. You can also toggle Autoproject on and off while sketching by right-clicking and selecting Autoproject from the menu.

Autoproject edges for sketch creation and edit

When checked, automatically projects all of the edges that define that plane onto the sketch plane as reference geometry when you create a new sketch.

Look at sketch plane on sketch creation and edit

When checked, automatically changes the view orientation to look directly at the new or active sketch.

Autoproject part origin on sketch create

When checked, the parts origin point will automatically be projected when a new sketch is created. It is recommended to keep this setting on.

Point alignment

When checked, automatically infers alignment (horizontal and vertical) between endpoints of newly created geometry. No sketch constraint is applied. If this option is not checked, points can still be inferred; this technique is covered later in this chapter in the Inferred Points section.

UNITS

Autodesk Inventor uses a default unit of measurement for every part and assembly file. The default unit is set from the template file from which you created the part or assembly file. When specifying numbers in dialog boxes with no unit, the default unit will be used. You can change the default unit in the active part or assembly document by clicking the Tools tab > Options panel > Document Settings button and click the Units tab as shown in the following image. The unit system values change for all of the existing values in that file.

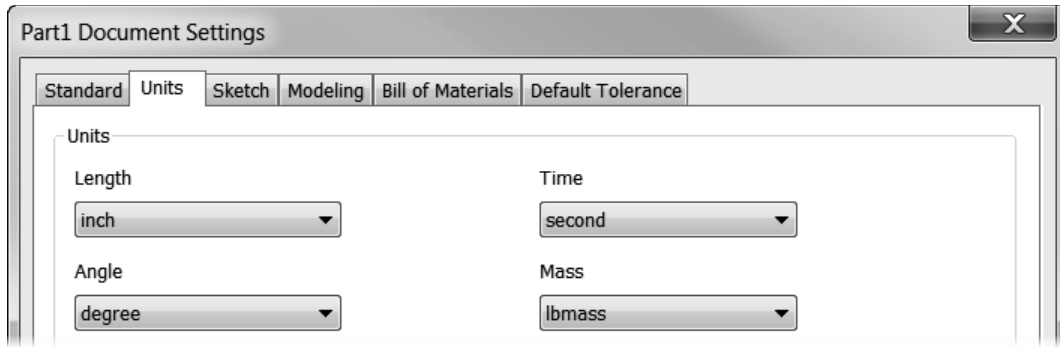

Figure 2-3



TIP: In a drawing file, the appearance of dimensions is controlled by dimension styles. Drawing settings are covered in Chapter 5.

You can override the default unit for any value by entering the desired unit. If you were working in a metric file whose unit is set to mm, for example, and you placed a 20 mm horizontal dimension as shown in the following image on the left, and you edited the dimension to 1 in (adding the unit) as shown in the middle image, the dimension would appear on the screen in the default units which would be 25.4 as shown in the right image.



Figure 2-4

When you edit a dimension, the overridden unit appears in the Edit Dimension dialog box. For the previous example when the 25.4 mm dimension is edited, 1 in is displayed in the Edit Dimension dialog box as shown in the following image.



Figure 2-5

TEMPLATES

Each new file is created from a template. You can modify existing templates or add your own templates. As you work, make note of the changes that you make to each file. You then create a new template file or modify an existing file that contains all of the changes and save that file to your template directory, which by default in Windows 7 is *C:\Users\Public\Public Documents\Autodesk\Inventor 2016\Templates*. You can also create a new subdirectory under the templates folder, and place any Autodesk Inventor file in this new directory. After adding an Inventor file the new tab will appear, and it will be available as a template.

You can use one of two methods to share template files among many users. You can modify the location of templates by clicking the Inventor Application Menu > Options button > File tab, and modifying the Templates location as shown in the following image. The Templates location will need to be modified for each user who needs access to templates that are not stored in the local location.



Figure 2-6

You can also change the unit of measurement (inches or millimeters) for the default part and assembly template files and set the default drawing standard (ANSI, DIN, ISO, etc.) for the default drawing template by clicking Application Option Menu > File tab > Configure Default Template button as shown in the previous image or click Configure Default Templates from the My Home screen as shown in the following image on the left. Then make the changes in the Configure Default Template dialog box as shown in the following image on the right.

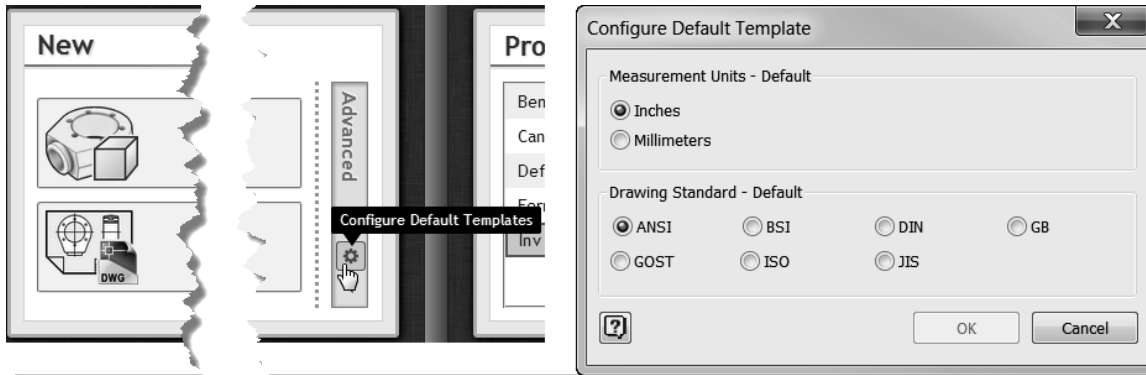

Figure 2-7

You can also set the Templates location in each project file. This method is useful if you need different template files for each project. While editing a project file, change the Templates location in the Folder Options area. The following image shows the default location in Windows 7. The Template location in the project file takes precedence over the Templates option in the Application Options, File tab.

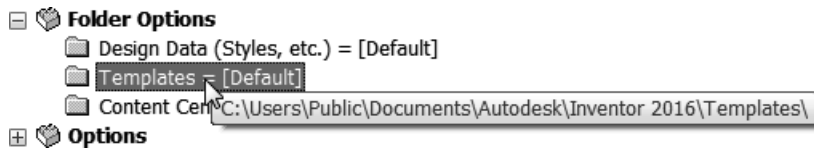

Figure 2-8



TIP: Template files have file extensions that are identical to other files of the same type, but they are located in the template directory. Template files should not be used as production files.

CREATING A PART FILE

The first step in creating a part is to start or create a new part file in an assembly. You can use the following methods to create a new part file:

- In the Quick Access toolbar click the down arrow on the New icon, and click Part as shown in the following image on the left. This creates a new part file based on the default unit as was discussed in the previous Templates section.
- Click Part on the My Home page as shown in the middle image.
- From the Inventor Application menu click New > Part as shown in the image on the right.

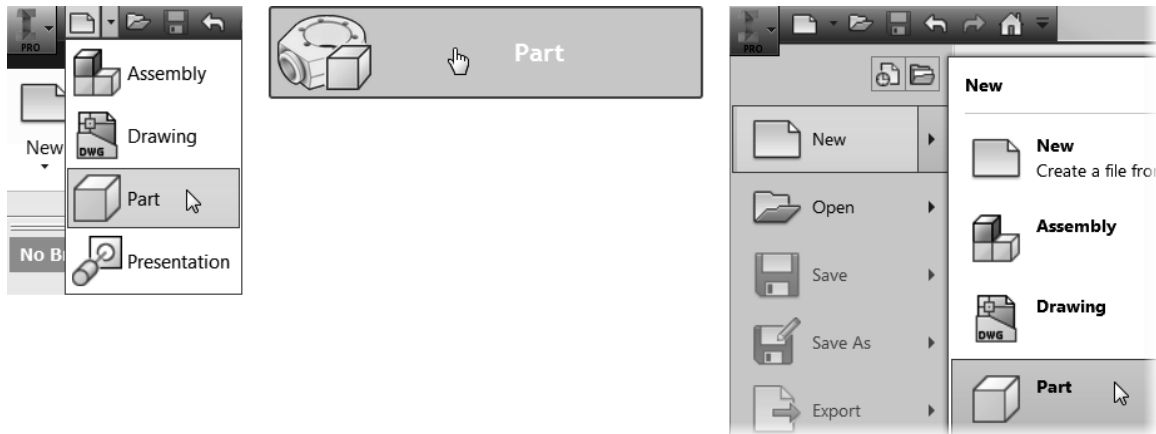

Figure 2-9



TIP: The default unit for the part and assembly templates and the standard for the drawing template is set in the Application Options dialog box > File tab > Configure Default Template.

Creating a Part File from a Specified Template

You can also create a part file from a template that is not the default location by clicking the New file command from one of these areas:

- Quick Access toolbar as shown in the following image on the left.
- Inventor Application menu, as shown in the middle image.
- Get Started tab > Launch Panel as shown in the image on the right.
- Or press CTRL + N.

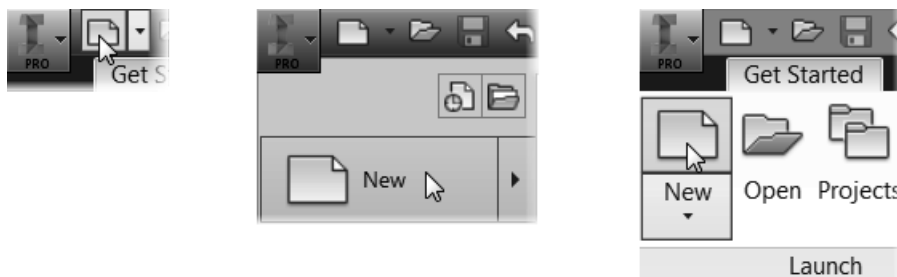

Figure 2-10

The Create New File dialog box appears. Then click the desired templates folder on the left side of the Create New File dialog box and then from the Part section on the right side of the dialog box click on the desired part template file, as shown in the following image.

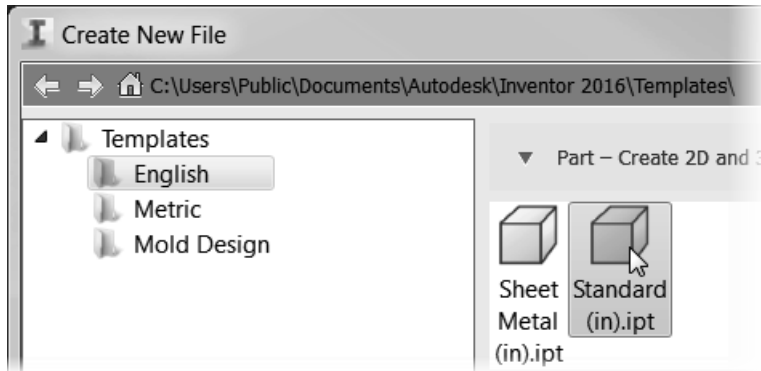

Figure 2-11

Another option to create a file, based on a specific template, is to utilize the My Home screen. Follow these steps.

1. Make the My Home screen current by clicking the Get Started tab > My Home Panel > Home.
2. Click on Advanced in the New file section as shown in the following image on the left.
3. Select the desired template folder and then the specific template file as shown in the following image on the right.

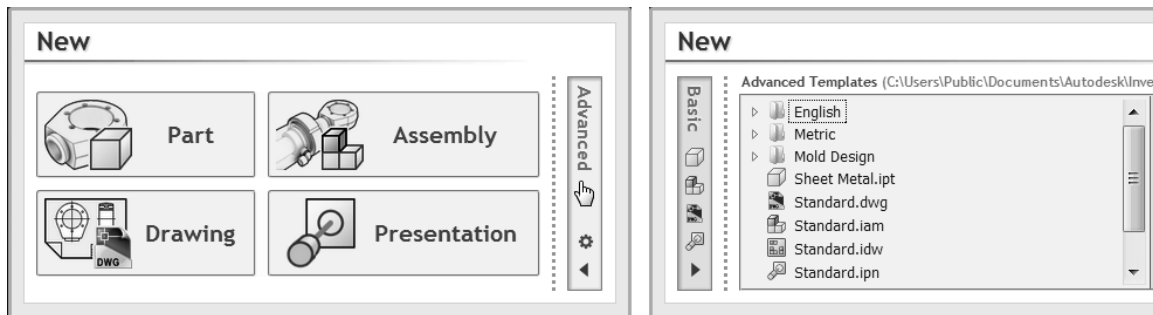

Figure 2-12

After starting a new part file using one of the previous methods, Autodesk Inventor's screen will change to reflect the part environment.

Sketches and Origin (Default) Planes

Before you start sketching, you select a plane on which to draw. A sketch is a plane on which 2D objects are sketched. You can use any planar part face or work plane to create a sketch. By default, when you create a new part file no sketch is created, and you will select an origin plane to sketch on. You can change the default plane on which you will create the sketch by selecting the Inventor Application Menu > Options and clicking on the Part tab. Select the sketch plane to which new parts should default.

Each time you create a new Autodesk Inventor part or assembly file, there are three planes (XY, YZ, and XZ), three axes (X, Y, and Z), and the center (origin) point at the intersection of the three planes. You can use these default planes to create an active sketch. To see the planes, axes, or center point, expand the Origin entry in the browser by clicking on the left side of the text. You can then move the cursor over the names, and they will appear in the graphics window. The following image on the left and the middle image illustrate the default planes, axes, and center point with their visibility on. To leave the visibility of the planes or axes on, right-click in the browser while the cursor is over the name and click Visibility from the menu. When a plane is

visible you can display the plane's label by moving the cursor over a plane in the browser or in the graphics window as shown in the following image on the right.

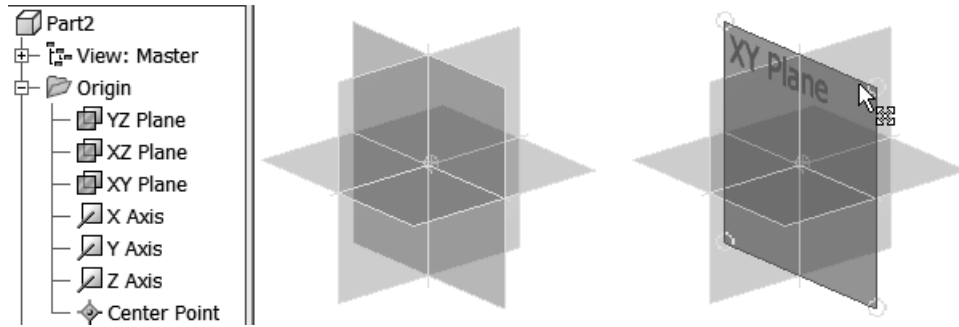

Figure 2-13

Origin 3D Indicator

When working in 3D, it is common to get your orientation turned around. By default in the lower left corner of the graphics screen, there is an XYZ axis indicator that shows the default (world) coordinate system as shown in the following image on the left. The direction of these planes and axes cannot be changed. The arrows are color-coded:

- Red arrow = X axis
- Green arrow = Y axis
- Blue arrow = Z axis

In the Application Options dialog box > Display tab, you can turn the axis indicator and the axis labels on and off as shown in the following image on the right.

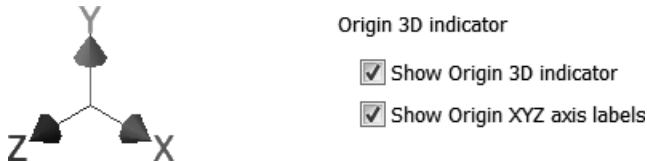

Figure 2-14

By default, Inventor will automatically project the origin point (0,0) when a new sketch is created in a part file. The origin point can be used to constrain a sketch to the 0, 0 point of the sketch. If desired, you can turn this option off by clicking the Tools tab > Application Options or the Application Menu > Options > Sketch tab, and then uncheck Autoproject part origin on sketch create as displayed in the following image.

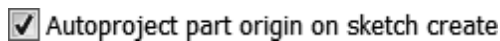

Figure 2-15

New Sketch

By default, when you create a new part file no sketch is active. You can define a plane from the origin folder to be the default by selecting a default plane from the Inventor Application Menu > Options > Part tab. Issue the 2D Sketch command to create a new sketch on a planar part face or a work plane or to activate a non-active sketch in the part. When you are in a part file that does not have a sketch defined and when you start the 2D Sketch command, the origin planes will be displayed in the graphics window, and you can select one of these planes to create the sketch on. To create a new sketch or make an existing sketch active, use one of these methods:

- Click the 3D Model tab > Sketch panel > Start 2D Sketch as shown in the following image on the left or from the Sketch tab > Sketch panel > Start 2D Sketch. Then click a planar face, a work plane, or an existing sketch in the browser.
- Press the S key (a keyboard shortcut) and click a planar face of a part, a work plane, or an existing sketch in the browser.
- While not in the middle of an operation, right-click in the graphics window, and select New Sketch from the marking menu as shown in the middle image. Then click a planar face, a work plane, or an existing sketch in the browser.
- While not in the middle of an operation, click a planar face of a part, a work plane, or an existing sketch in the browser. Then right-click in the graphics window, and click 2D Sketch from the mini-toolbar as shown in the following image on the right.



TIP: You can either start the command first, and then select a plane or you can select a plane and then start the command.

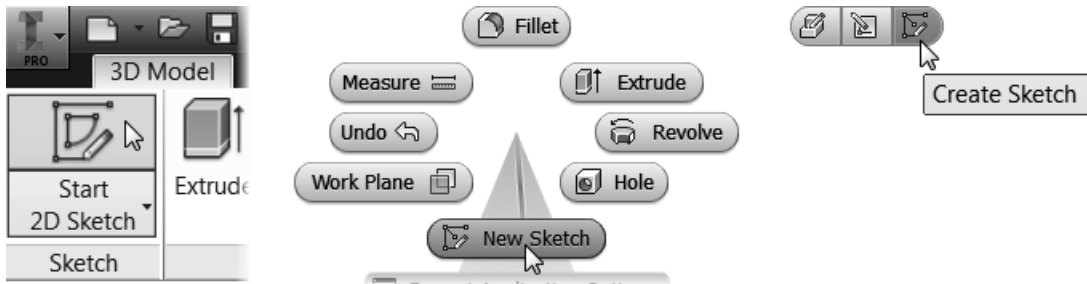

Figure 2-16

After creating a sketch, a Sketch entry will appear in the browser as shown in the following image, and a Sketch tab will appear in the ribbon. By default after you have defined a sketch, the X and Y-axes will align automatically to this plane, and you can begin to sketch.

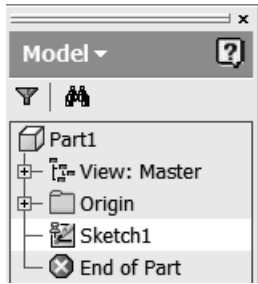

Figure 2-17

STEP 1 — SKETCH THE 2D OUTLINE OF THE PART

As stated at the beginning of this chapter, 3D parts usually start with a 2D sketch of the outline shape of the part. You can create a sketch with lines, arcs, circles, splines, or any combination of these elements. The next section will cover sketching strategies, commands, and techniques.

Sketching Overview

When deciding what outline to start with, analyze how the finished shape will look. Look for the 2-dimensional shape that best describes the part. When looking for this outline, try to look for a flat 2-dimensional shape that can be extruded or revolved to create a shape that other features can be added to, to create the finished part. It is usually easier to sketch 2-dimensional geometry than 3-dimensional geometry. As you gain modeling experience, you can reflect on how you created

the model and think about other ways that you could have built it. There is usually more than one way to generate a given part.

When sketching, draw the geometry so that it is close to the desired shape and size— you do not need to be concerned about exact dimensional values. Even though Inventor allows islands in the sketch (closed objects that lie within another closed object) it is NOT recommended to sketch islands (when you extrude a sketch, island(s) may become voids in the solid). A better method is to place features, which make editing a part easier. For example, instead of sketching a circle inside a rectangle to represent a hole, extrude a rectangle and then place a hole feature.

The following guidelines will help you successfully generate sketches:

- Select a 2-dimensional outline that best represents the part. The 2D outline will be used to create the base feature. A base feature is the first feature and to which other features will add or remove material from.
- Draw the geometry close to the finished size. If you want a 20-inch square, for example, do not draw a 200-inch square. Use dynamic input to define the size of the geometry. Dynamic input is covered in a later section in this chapter.
- Create the sketch proportional in size to the finished shape. When drawing the first object, verify its size in the lower-right corner of the status bar. Use this information as a guide.
- Draw the sketch so that it does not have geometry over geometry, that is, a line on top of another line.
- Do not allow the sketch to have a gap; the geometry should start and end at a single point, just as the start and end points of a rectangle share the same point.
- Keep the sketches simple. Leave out fillets and chamfers when possible. You can easily place them as features after the sketch turns into a solid. The simpler the sketch, the fewer the number of constraints and dimensions that will be required to constrain the model.

Sketching Commands

Before you start sketching the outline of the part, examine the 2D sketching commands that are available. After creating a sketch, the 2D sketch tab is current in the ribbon. The most frequently used commands will be explained throughout this chapter. Consult the help system for information about the remaining commands.

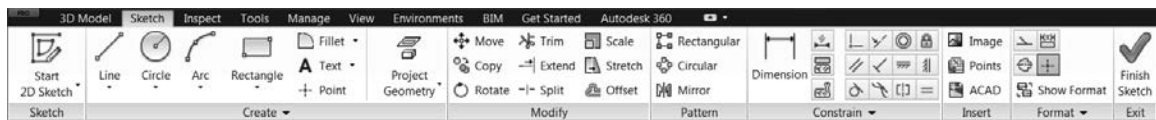

Figure 2-18

Using the Sketch Commands

After starting a new part, a sketch will automatically be active so that you can now use the sketch commands to draw the shape of the part. To start sketching, issue the sketch command that you need, click a point in the graphics window, and follow the prompt on the lower-left corner of the status bar. The sections that follow will introduce techniques that you can use to create a sketch.

Dynamic Input in the sketch environment makes a Heads-Up Display (HUD), which shows information near the cursor for many sketching commands that helps you keep your eyes on the screen. While using the Line, Circle, Arc, Rectangle, or Point commands, you can enter values in the input fields. You can toggle between the value input fields by pressing the TAB key. The following image shows examples of entering Cartesian coordinates and Polar coordinates.



TIP: If no data is entered in the input fields and you click in the graphics window to locate geometry, dimensions will NOT automatically be placed. You can manually place dimensions and constraints after the geometry is sketched.

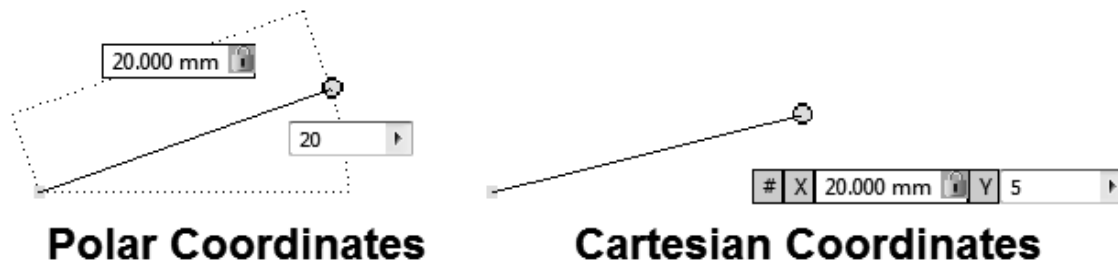

Figure 2-19

Dimension Input

When defining lengths and angles for a second point, the dimensional values change as you move the cursor. Press TAB to move to the next input field or click in another cell. After entering a value and pressing the Tab key, the value will be locked and a lock icon will appear to the right of the value as shown in the following image. After a dimension's value is locked, the parametric dimension will be created after clicking a point or pressing the Enter key. You can change the value in an input field by either clicking in the field or pressing the Tab key until the field is highlighted and then typing in a new value.

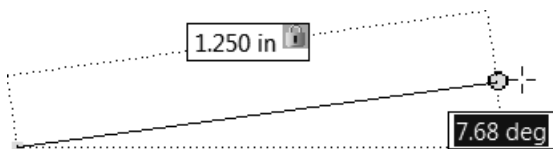

Figure 2-20

Line Command

The Line command is one of the most powerful commands that you will use to sketch. Not only can you draw lines with it, but you can also draw an arc from the endpoint of a line segment. To start sketching lines, click the Line command from the Sketch tab > Create panel as shown in the following image on the left, or right-click in a blank area in the graphics window and click Create Line from the marking menu as shown in the middle image, or press the L key on the keyboard. After starting the Line command you will be prompted to click a first point, select a point in the graphics window, and then click a second point. The image on the right shows the line being created with the dynamic input as well as the horizontal constraint.

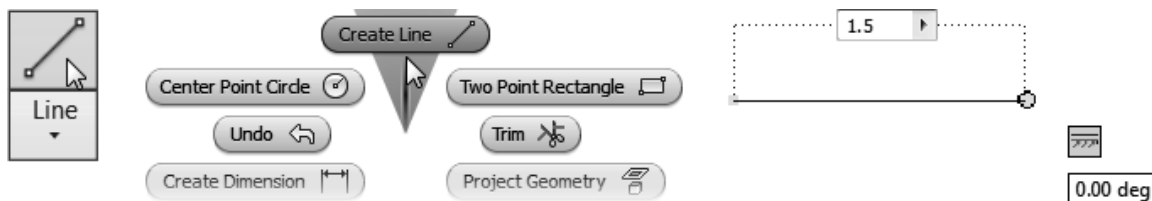

Figure 2-21

You can continue drawing line segments, or you can sketch an arc from the endpoint. Move the cursor over the endpoint of a line segment or arc, and a small gray circle will appear at that endpoint as shown in the following image on the left. Click on the small circle, and with the left mouse button pressed down, move the cursor in the direction that you want the arc to go. Up to

eight different arcs can be drawn, depending upon how you move the cursor. The arc will be tangent to the horizontal or vertical edges that are displayed from the selected endpoint. The following image on the right shows an arc that is normal to the sketched line being drawn.

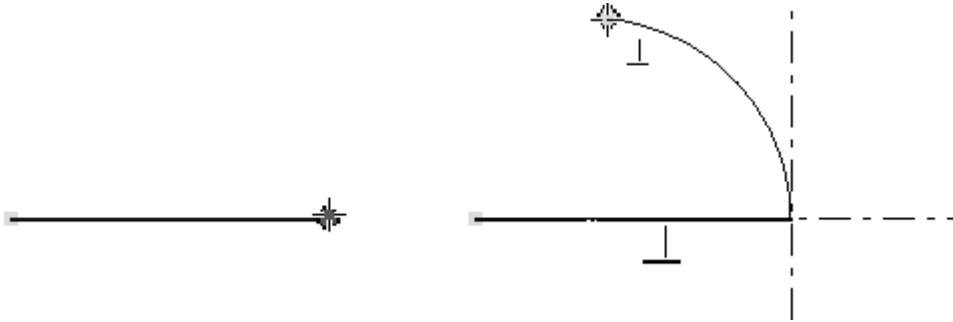

Figure 2-22



TIP: When sketching, look at the bottom-right corner of the status bar (bottom of the screen) to see the coordinates, length, and angle of the objects that you are drawing. The following image shows the status bar when a line is being drawn.

1.500 in, 0.000 in x=1.500 in y=0.000 in

Figure 2-23

Object Tracking – Inferred Points

If the Point Alignment On option is checked from the Sketch tab of the Application Options, dashed lines will appear on the screen as you sketch. These dotted lines represent the endpoints; midpoints; and theoretical intersections of lines, arcs, and center points of arcs and circles that represent their horizontal, vertical, or perpendicular positions. As the cursor gets close to these inferred points, it will snap to that location. If that is the point that you want, click that point; otherwise, continue to move the cursor until it reaches the desired location. When you select inferred points, no constraints (geometric rules such as horizontal, vertical, collinear, and so on) are applied from them. Using inferred points helps create more accurate sketches. The following image shows the inferred points from two midpoints that represent their horizontal and vertical position.

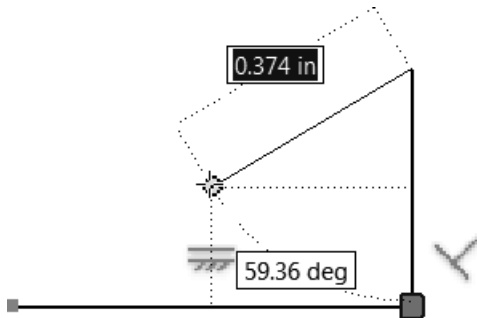

Figure 2-24

Automatic Constraints

As you sketch, a small constraint symbol appears that represents geometric constraint(s) that will be applied to the object. If you do not want a constraint to be applied hold down the CTRL key when you click to create the geometry. The following image shows a line being drawn from the

arc, tangent to the arc, and parallel to the angled line, and the dynamic input is also displayed. The symbol appears near the object from which the constraint is coming. Constraints will be covered in the next section.

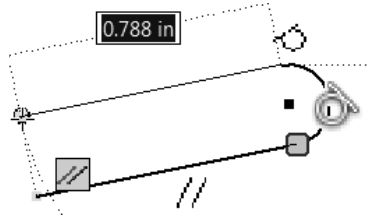

Figure 2-25

Scrubbing

As you sketch, you may prefer to apply a constraint different from the one that automatically appears on the screen. You may want a line to be perpendicular to a given line, for example, instead of being parallel to a different line. The technique to change the constraint is called scrubbing. To place a different constraint while sketching, move the cursor so it touches (scrubs) the other object to which the constraint should be related. Move the cursor back to its original location, and the constraint symbol changes to reflect the new constraint. The same constraint symbol will also appear near the scrubbed object, representing that it is the object to which the constraint is matched. Continue sketching as normal. The following image shows the top horizontal line being drawn with a parallel constraint that was scrubbed from the bottom horizontal line. Without scrubbing the bottom horizontal line, the applied constraint would have been perpendicular to the right vertical line.

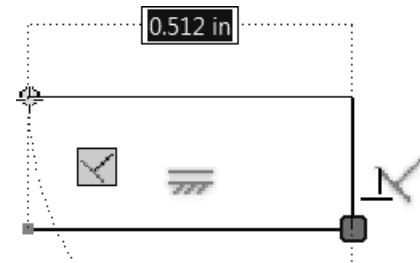

Figure 2-26

Common Sketch Commands

The following table lists common 2D sketch commands. Some commands are available by clicking the down arrow in the lower-right corner of the top command in the panel. Consult the help system for more information about these commands.

Command	Function
Center-point Circle	Creates a circle by clicking a center point for the circle and then a point on the circumference of the circle.
Tangent Circle	Creates a circle that will be tangent to three lines or edges by clicking the lines or edges.
Three-Point Arc	Creates an arc by clicking a start and endpoint and then a point that will lie on the arc.
Tangent Arc	Creates an arc that is tangent to an existing line or arc by clicking the endpoint of a line or arc and then clicking a point for the other endpoint of the arc.
Center-Point Arc	Creates an arc by clicking a center point for the arc and then clicking a start and endpoint.
Two-Point	Creates a rectangle by defining a point and then clicking another point to define the

Rectangle	opposite side of the rectangle. The edges of the rectangle will be horizontal and vertical. If values were entered, dimensions will be placed on the rectangle.
Three-Point Rectangle	Creates a rectangle by clicking two points that will define an edge and then clicking a point to define the third corner. You can also type values to define the three points of the rectangle, and dimensions will be created that define the size of the rectangle.
Two-Point Center Rectangle	Creates a rectangle by defining a center point and another point to define the rectangle's size or type values for the center point and its X and Y values of the rectangle. The edges of the rectangle will be horizontal and vertical, and if values were entered, dimensions will be created.
Three-Point Center Rectangle	Creates a rectangle by defining a center point, a point to define the rectangle's starting point and its angle and another point size or type values for the center point, and size of the rectangle. The edges of the rectangle will be horizontal and vertical, and if values were entered, dimensions will be created.
Center To Center Slot	Creates a slot by defining the center-to-center distance, angle, and then the diameter.
Overall Slot	Creates a slot by defining the overall distance, angle, and then the diameter.
Center Point Slot	Creates a slot by defining the center-to-center distance, angle, and then the diameter.
Three Point Arc Slot	Creates an arc slot by defining a start point, end point and an angle, a radius of the center of the slot and then the diameter of the slot.
Center Point Arc Slot	Creates an angled slot by defining a radius of the center of the slot and a starting angle, an ending angle and then the diameter of the slot.
Fillet	Creates a fillet between two nonparallel lines, two arcs, or a line and an arc at a specified radius. If you select two parallel lines, a fillet is created between them without specifying a radius. When the first fillet is created, a dimension will be created. If many fillets are placed in the same operation, you choose to either apply or not apply an equal constraint.
Chamfer	Creates a chamfer between lines. There are three options to create a chamfer: both sides equal distances, two defined distances, or a distance and an angle.
Polygon	Creates an inscribed or a circumscribed polygon with the number of faces that you specify. The polygon's shape is maintained as dimensions are added.
Mirror	Mirrors the selected objects about a centerline. A symmetry constraint will be applied to the mirrored objects.
Rectangular Pattern	Creates a rectangular array of a sketch with a number of rows and columns that you specify.
Circular Pattern	Creates a circular array of a sketch with a number of copies and spacing that you specify.
Offset	Creates a duplicate of the selected objects that are a given distance away. By default, an equal-distance constraint is applied to the offset objects.
Trim	Trims the selected object to the next object it finds. Click near the end of the object that you want trimmed. While using the Trim command, hold down the SHIFT key to extend objects. If desired, hold down the CTRL key to select boundary objects. While in the Trim command you can also hold down the left mouse button and move the cursor to dynamically trim geometry. While in the Dynamic mode you can hold down the Shift key to dynamically extend geometry.
Extend	Extends the selected object to the next object it finds. Click near the end of the object that you want extended. While using the Extend command, hold down the SHIFT key to trim objects. If desired, hold down the CTRL key to select boundary objects. While in the Extend command you can also click and hold down the left mouse button and move the cursor to dynamically extend geometry. While in the Dynamic mode you can hold down

the Shift key to dynamically trim geometry.

Selecting Objects

After sketching objects, you may need to move, rotate, or delete some or all of the objects. To edit an object, it must be part of a selection set. There are multiple methods that you can use to place objects into a selection set.

- **CTRL or SHIFT Keys.** You can select objects individually by clicking on them. To manually select multiple individual objects, hold down the CTRL key or SHIFT key while clicking the objects. You can remove selected objects from a selection set by holding down the CTRL or SHIFT key and reselecting them. As you select objects, their color will change to show that they have been selected.
- **Window.** You can select multiple objects by defining a selection window. Not all commands allow you to use the selection window technique and only allow single selections. To define the window, click a starting point. With the left mouse button depressed, move the cursor to define the box. If you draw the selection window from left to right (solid lines), as shown in the following image on the left, only the objects that are fully enclosed in the window will be selected.
- **Crossing window.** If you draw the selection window from right to left (dashed lines), as shown in the following image on the right, a crossing window is used and all of the objects that are fully enclosed in the selection window and the objects that are touched by the window will be selected.
- You can use a combination of the methods to create a selection set.

When you select an object, its color will change according to the color style that you are using. To remove all of the objects from the selection set, click in a blank section of the graphics window.

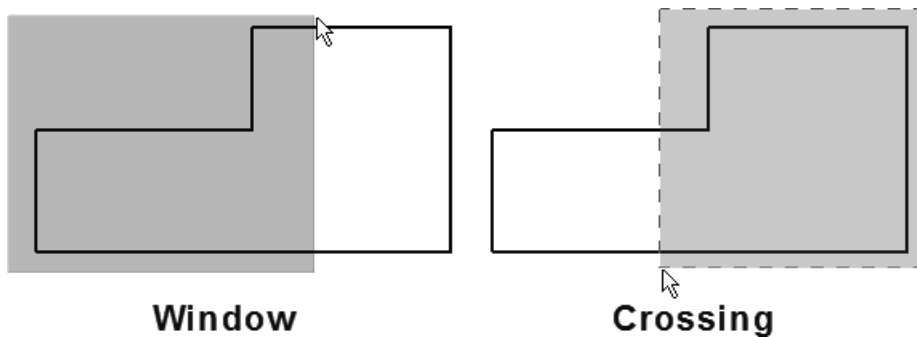

Figure 2-27

Deleting Objects

To delete objects first cancel the command that you are in by pressing the ESC key. Then select objects to delete, and either press the DELETE key or right-click and click Delete from the menu as shown in the following image.

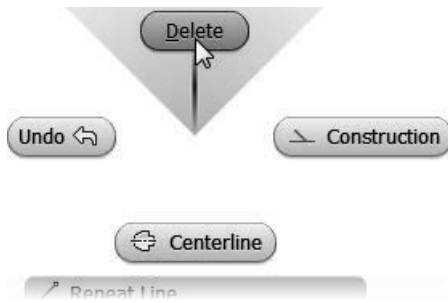

Figure 2-28

Distance Commands

Distance (measure) commands can assist in analyzing sketch, part, and assembly models. The distance command is not a replacement for dimensions; they are additional tools to give you more information. You can measure distances, angles, and loops, and you can perform area calculations. You can start the measure command first and then select the geometry, or select the geometry and then start a measure command.

The Distance commands are located on the Inspect tab > Measure panel as shown in the following image on the left. It can also be added to the Quick Access toolbar by clicking the down arrow to the right of the Quick Access toolbar and click Distance from the menu as shown in the middle image. Once the Distance option is added you can access the distance commands as shown in the image on the right.

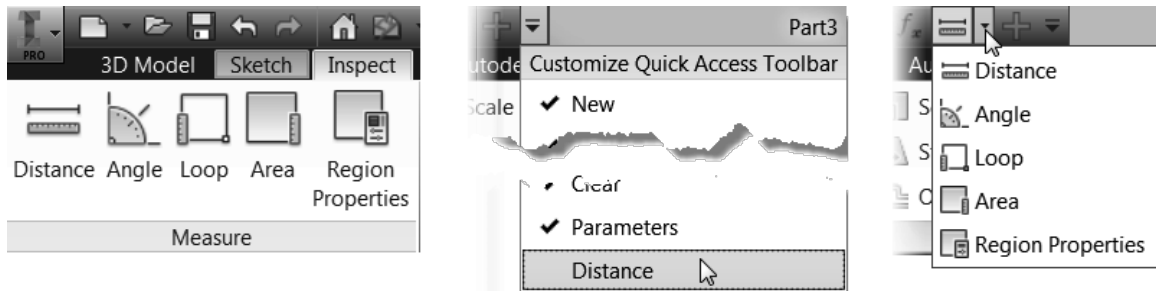

Figure 2-29

Below is a description of measure commands.

Distance

Measures the distance for the following: an edge or line, diameter or radius of a cylindrical face or circle, distance between two points, and distance between two components in an assembly (will be covered in Chapter 6 Assemblies).

Angle

Measures the angle between two edges or lines, or between three points.

Measure Loop

Measures the length of closed or open loops defined by face boundaries or other geometry. When moving your cursor over a part face, all edges of the face will become highlighted. Clicking on this face will calculate the closed loop or perimeter of the shape.

Measure Area

Measures the area of enclosed regions or faces. Moving your cursor inside the closed outer shape will cause the outer shape and all holes (referred to as “islands”) to also become highlighted. Clicking inside this shape will calculate the area of the shape.

When you click the arrow beside the Measure dialog box, a menu will appear as shown in the following image. Use these options to start a new measure command, add or clear the accumulate value, add another unit, or change the precision of the displayed results.

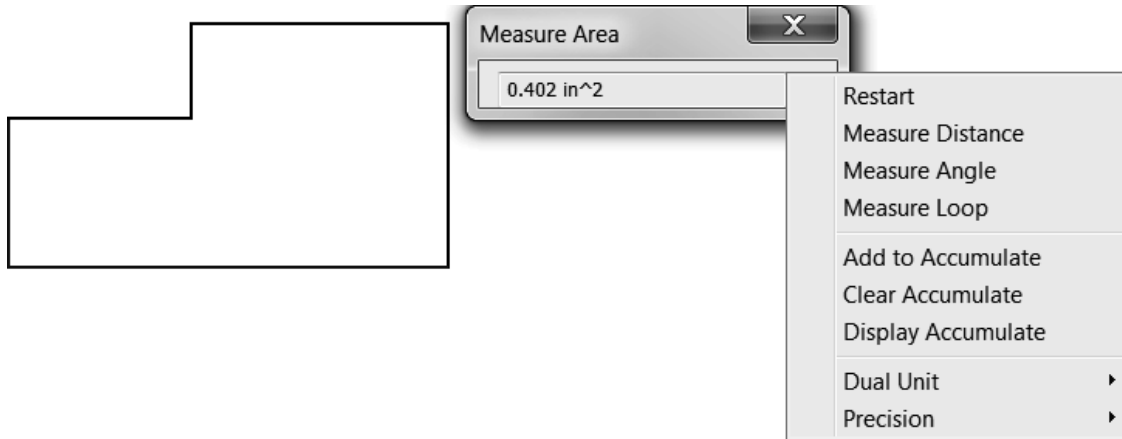

Figure 2-30

Region Properties

While in a sketch you can determine the properties such as the area, perimeter, and Moment of Inertia of a closed 2D sketch. All measurements are taken from the sketch coordinate system (0,0). After selecting a closed region, click the Calculate button. The properties can be displayed in dual units, the default unit of the document, or a unit of your choice. The following image shows the region properties of a closed profile that has voids consisting of a circle and a slot.

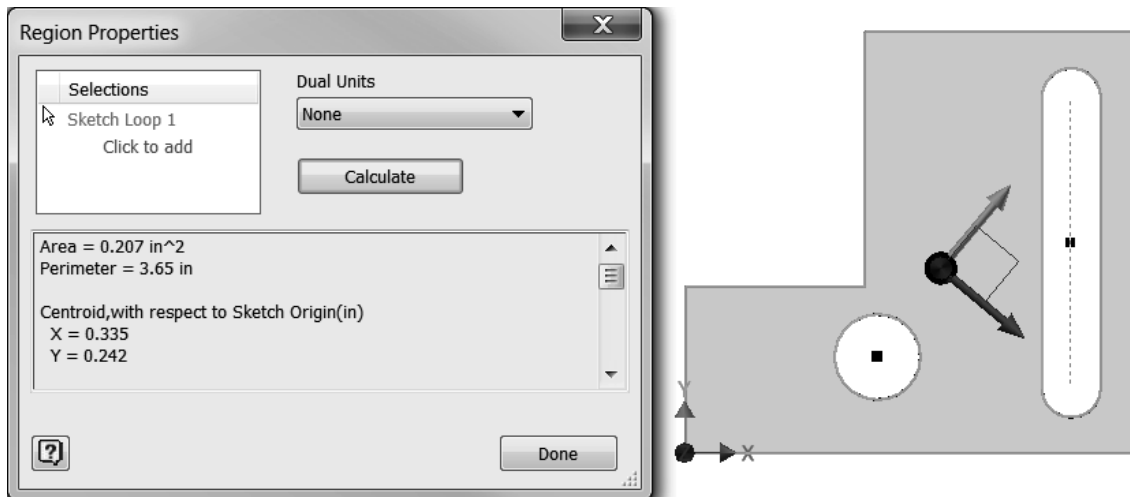

Figure 2-31

EXERCISE 2-1: CREATING A SKETCH WITH LINES

In this exercise, you create a new part file, and 2D Sketch geometry using basic construction techniques. In this exercise no dimensions will be created.

1. Click the New command on the Quick Access toolbar, click the English folder, and then double-click Standard (in).ipt or if inch is the default unit; from the left side of the Quick Access toolbar you can click the down arrow on the New icon and click Part.
2. Click the Start 2D Sketch command on the 3D Model tab > Sketch panel and then select the XY origin plane in the graphics window as shown in the following image.

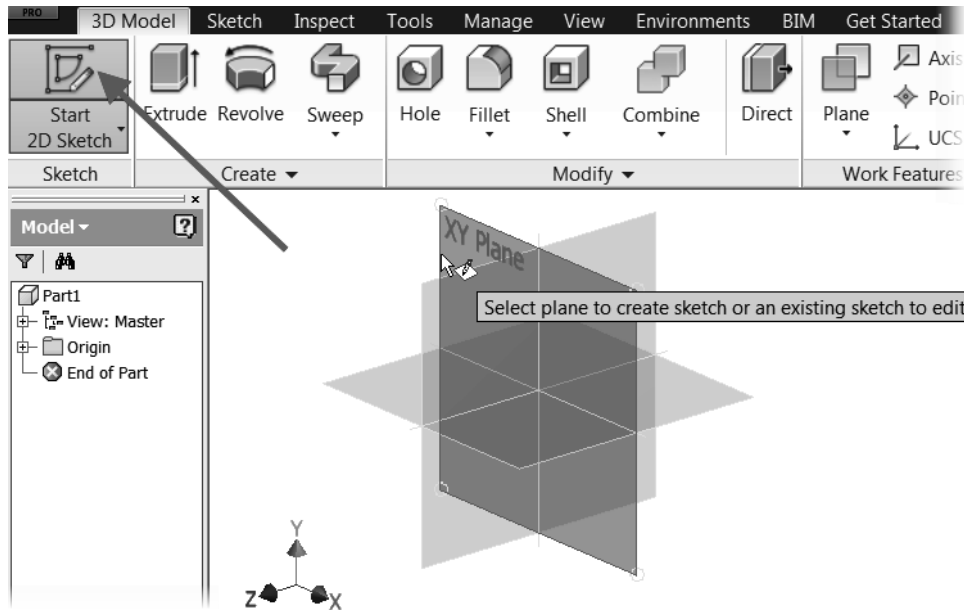

Figure 2-32

3. Start the Line command from the Sketch tab > Create panel.
4. Click on the origin point in the graphics window, move the cursor to the right approximately 4 inches, and when the horizontal constraint symbol displays, click to specify a second point as shown in the following image. You may need to zoom back and pan the screen to see the entire line.

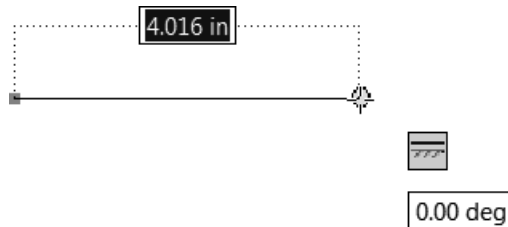

Figure 2-33



TIP: Symbols indicate the geometric constraints. In the image above, the symbol indicates that the line is horizontal. When you create the first entity in a sketch, make it close to final size.

5. Move the cursor up until the perpendicular constraint symbol displays beside the first line and then click to create a perpendicular line that is approximately 2 inches as shown in the following image on the left.

6. Move the cursor to the left and create a horizontal line approximately 1 inch, that is, perpendicular to the vertical line. The perpendicular constraint symbol is displayed as shown in the following image on the right.

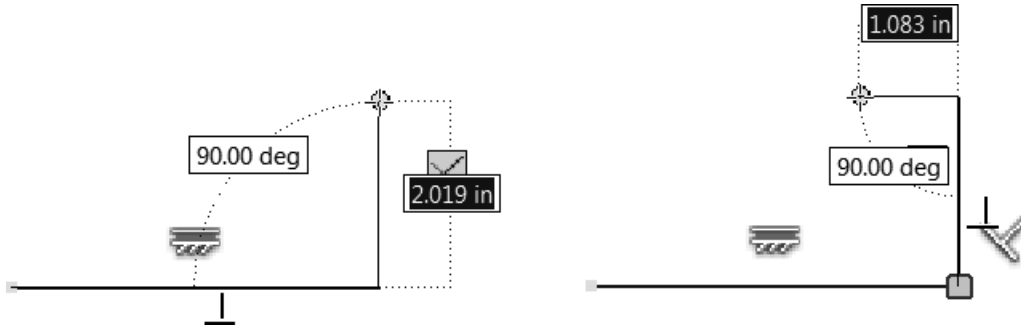

Figure 2-34

7. Move the cursor down, and create a line that is perpendicular to the top horizontal line and is approximately 1 inch.
8. Move the cursor left to create a line that is approximately 2 inches long and is perpendicular to the inside vertical line.
9. Move the cursor up and notice the perpendicular constraint symbol is displayed; to apply a parallel constraint instead, move (scrub) the cursor over the inside vertical line to create a relationship to it. Then click when an inferred line (horizontal dotted line) appears from the top point as shown in the following image on the left.
10. Move the cursor to the left until the perpendicular constraint symbol is displayed, and an inferred vertical line appears from the bottom left point as shown in the following image on the right and then click to locate the point.

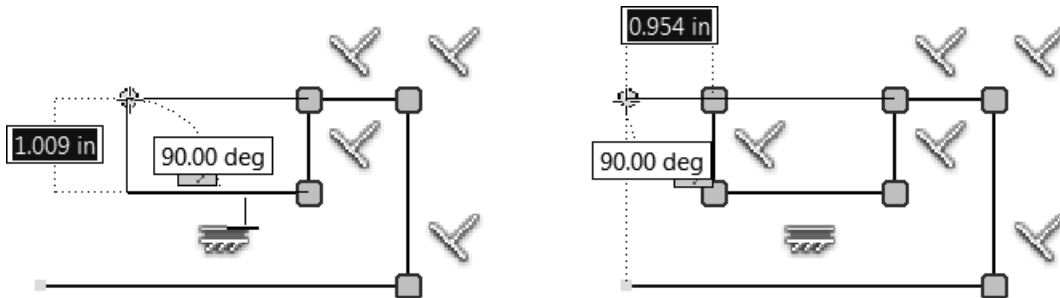

Figure 2-35

11. To close the profile right-click and click Close from the menu.
12. Your screen should resemble the following image.
13. Right-click in the graphics screen, and click Finish 2D Sketch.
14. Close the file. Do not save changes. End of exercise.

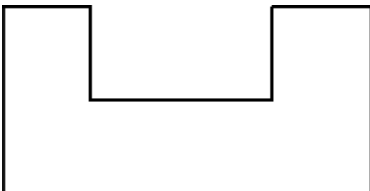

Figure 2-36

EXERCISE 2-2: CREATING A SKETCH WITH TANGENCIES

In this exercise, you create a new part file, and then you create a profile consisting of lines and tangent arcs.

1. Click the New command, and then double-click Standard (inch).ipt; or if inch is the default unit, from the left side of the Quick Access toolbar you can click the down arrow of the New icon, and select Part.
2. Click the Start 2D Sketch command on the 3D Model tab > Sketch panel and then select the XY origin plane.
3. Start the Line command by right-clicking in a blank area in the graphics window and click Create Line from the marking menu.
4. Click on the projected origin point in the middle of the graphics window, and create a horizontal line to the right of the origin point and type **3** (inches will be assumed as the unit because the part file is based on the unit of inch) in the input field. Press the tab key and move the cursor until the horizontal constraint symbol appears and then click. If the second point of the line lies off the screen, roll the mouse wheel away from you to zoom out, hold down the mouse wheel, and drag to pan the view.
5. Create a perpendicular line, move the cursor up until the perpendicular constraint appears, type **1.5** in the input field as shown in the following image on the left, and then press enter.
6. In this step, you infer points, meaning that no sketch constraint is applied. Move the cursor to the intersection of the midpoints of the right-vertical line and bottom horizontal line. Dotted lines (inferred points) appear as shown in the image on the right, and then click to create the line. No dimension was created since a value was not entered.

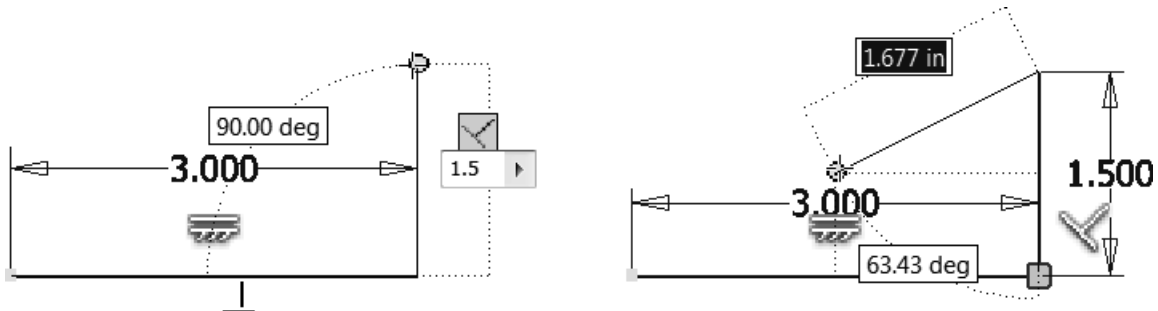

Figure 2-37

7. Next you create a line that is parallel to the bottom line. If needed scrub the bottom line by moving the cursor over the bottom line (do NOT click), and then move the cursor up and to the left until the vertical inferred line and the constraints are displayed as shown in the following image on the left, and then click to create the line.
8. Next you sketch an arc while in the line command. While still in the Line command move the cursor over the left endpoint of the top horizontal line until the gray circle appears, click on the gray dot at the left end of the line, and hold and drag the cursor to the left and then down to preview a tangent arc. Do not release the mouse button.
9. Move the cursor over the left endpoint of the first line segment until a coincident constraint (green circle) and the two tangent constraints at start and end points of the arc are displayed as shown in the following image on the right.

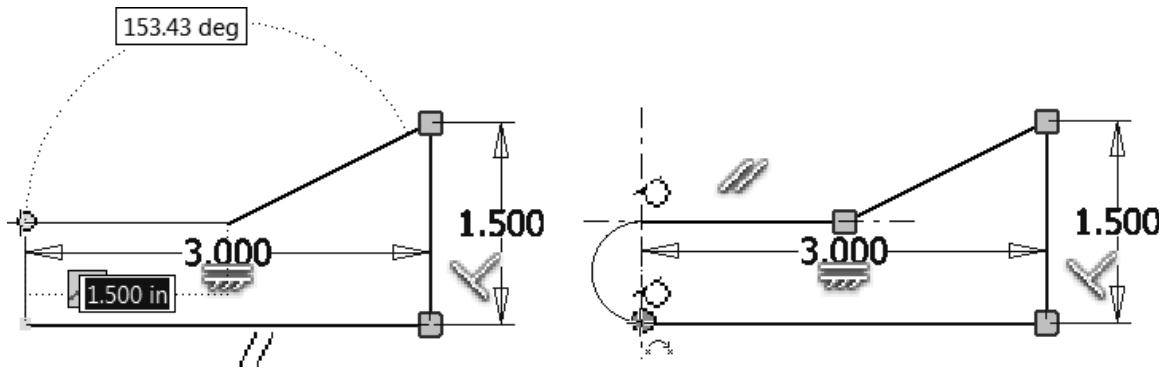

Figure 2-38

10. Release the mouse button to create the arc.
11. Right-click in the graphics window, and then click OK from the marking menu. Later in this chapter you will learn how to create dimensions.
12. Click Finish Sketch from the Sketch tab > Exit panel.
13. Close the file. Do not save changes. End of exercise.

STEP 2 — CONSTRAINING THE SKETCH

After you draw the sketch, you may want to add geometric constraints to it to add design intent. Geometric constraints apply behavior to a specific object or create a relationship between two objects. An example of using a constraint is applying a vertical constraint to a line so that it will always be vertical. You could apply a parallel constraint between two lines to make them parallel to one another; then, as the angle of one of the lines changes, so will the angle of the other line. You can apply a tangent constraint to a line and an arc or to two arcs.

When you add a constraint, the number of constraints or dimensions that are required to fully constrain the sketch will decrease. On the bottom-right corner of Autodesk Inventor, the number of constraints or dimensions will be displayed similar to what is shown in the following image. A fully constrained sketch is a sketch whose objects cannot move or stretch.

4 dimensions needed 1 1

Figure 2-39

Constrain to the Origin Point

When sketching, it is recommended to constrain a point on the sketch to the origin point with a coincident constraint or dimension a point on the sketch to the origin point so it cannot move. You could apply a fix constraint instead of using the origin point, but it is not recommended. When a sketch is constrained to the origin point, Inventor will change the color of constrained objects. If the sketch is not constrained to the origin point, objects are free to move in the sketch and the color of the objects will not change.



TIP: Autodesk Inventor does not force you to fully constrain a sketch. However, it is recommended that you fully constrain a sketch, as this will allow you to better predict how the change will affect the sketch and part.

Constraint Types

Autodesk Inventor has 12 geometric constraints that you can apply to a sketch. The following image shows the constraint types that can be applied from the Sketch tab > Constrain panel.



Figure 2-40

The following chart describes the geometric constraints.

Icon	Constraint	Function
	Coincident	A point is constrained to lie on another point or curve (line, arc, etc.).
	Collinear	Two selected lines will line up along a single line; if the first line moves, so will the second. The two lines do not have to be touching.
	Concentric	Arcs and/or circles will share the same center point.
	Fix	Applying a fix constraint to a point will prevent the selected point from moving. Multiple points in a sketch can be fixed. If you select a line segment, the angle of the line will be fixed and only its length can change.
	Parallel	Lines will be repositioned so that they are parallel to one another.
	Perpendicular	Lines will be positioned at 90° angles to one another.
	Horizontal	Line is positioned parallel to the X-axis, or a horizontal constraint can be applied between any two points in the sketch. The selected points will be aligned such that a line drawn between them will be parallel to the X-axis.
	Vertical	Line is positioned parallel to the Y-axis, or a vertical constraint can be applied between any two points in the sketch. The selected points will be aligned such that a line drawn between them will be parallel to the Y-axis.
	Tangent	An arc, circle, or line will become tangent to another arc or circle.
	Smooth (G2)	A spline and another spline, line, or arc that connect at an endpoint with a coincident constraint will represent a smooth G2 (continuous curvature) condition.
	Symmetry	Selected points defining the selected geometry are made symmetric about a selected line.
	Equal	If two arcs or circles are selected, they will have the same radius or diameter. If two lines are selected, they will become the same length. If one of the objects changes, so will the other object to which the Equal constraint has been applied. If the Equal constraint command is applied after one of the arcs, circles, or lines has been dimensioned, the second arc, circle, or line will take on the size of the first one. If you select multiple similar objects (lines, arcs, etc.) before selecting this command, the constraint is applied to all of them.

Adding Constraints

As stated previously in this chapter, you can apply constraints while you sketch objects. You can also apply additional constraints after the sketch is drawn. However, Autodesk Inventor will not allow you to over-constrain the sketch or add duplicate constraints. If you add a constraint that would conflict with another, you will be warned with the message, “Adding this constraint will over-constrain the sketch.” For example, if you try to add a vertical constraint to a line that already has a horizontal constraint, you will be alerted. To add a constraint, follow these steps:

1. Click a constraint from the Constrain panel, or right-click in the graphics window and click Create Constraint from the menu. Then click the specific constraint from the menu as shown in the previous image before the chart.
2. Click the object or objects then apply the constraint.

Showing Constraints

To display the geometric constraints that are applied to a sketch, do one of the following:

- Select the geometry in the graphics window by selecting individual objects or by using the window or crossing selection method that was described in the Selecting Objects section that was covered earlier in this chapter.
- Click the Show Constraints command from the Status Bar as shown in the following image on the left or from the Constrain panel as shown in the middle image.
- Right-click in a blank area in the graphics window and click Show All Constraints from the menu.
- Press the F8 key.

The constraints on the selected geometry will be displayed. The yellow squares represent coincident constraints; move the cursor over a yellow square to display the two coincident constraints for the point. The image on the right shows all the constraints in a sketch.

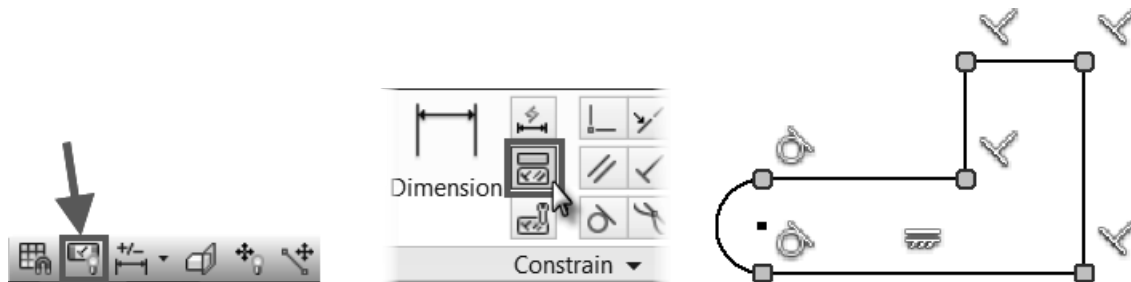

Figure 2-41

Modifying Constraint Size

You can modify the size of the constraint icons displayed on the screen by clicking Tools tab > Options panel > Application Options, and then modify the size of the Annotation Scale. The following image shows the Annotation Scale increased from 1.0 to 1.5. This setting also changes the size of the dimensions in a sketch. This change has no effect on the size of dimensions in a drawing.



Figure 2-42

Deleting Constraints

To delete the constraint(s), select a constraint or multiple constraints using one of the selection methods. Right-click and click Delete from the menu as shown in the following image on the left. As an alternate method to deleting a constraint, you can press the Delete key once the constraint is selected.

- To delete all constraints except the coincident constraints, use the window or crossing selection technique, right-click and click Delete Constraints from the menu as shown in the image on the right.



Figure 2-43

Hiding Constraints

You can hide the display symbol for individual or all geometric constraints. To perform this task, do one of the following:

To hide a constraint:

- Move the cursor over a constraint, right-click and click Hide from the marking menu as shown in the following image on the left.

To hide all constraints, do one of the following:

- Move the cursor over a constraint, right-click and click Hide All Constraints from the marking menu as shown in the image, second from the left.
- Click Hide All Constraints on the Status Bar as shown in the image, third from the left. This is the same icon you selected to Show All Constraints.
- Right-click in a blank area in the graphics window and click Hide All Constraints on the menu as shown in the following image on the right.
- Press the F9 key.

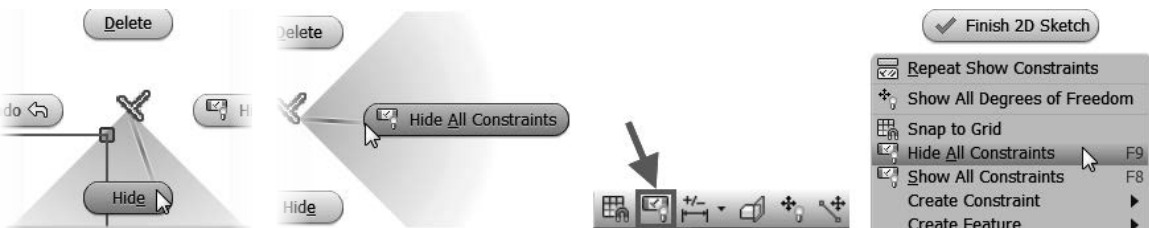

Figure 2-44

Construction Geometry

Construction geometry can help you create sketches that would otherwise be difficult to constrain. You can constrain and dimension construction geometry like normal geometry, but the construction geometry will not be recognized as a profile edge in the part when you turn the sketch into a feature. When you sketch, the sketches by default have a normal geometry style, meaning that the sketch geometry is visible in the feature. Construction geometry can reduce the

number of constraints and dimensions required to fully constrain a sketch, and it can help to define the sketch. For example, a construction circle that is tangent to the inside of a hexagon (drawn with individual lines and not the Polygon command) can drive the size of the hexagon. Without construction geometry, the hexagon would require six constraints and dimensions. With construction geometry, it would require only three constraints and dimensions; the circle would have tangent or coincident constraints applied to it and the hexagon. You create construction geometry by changing the line style before or after you sketch geometry in one of the following two ways:

- After creating the sketch, select the geometry that you want to change and click the Construction icon on the Format panel as shown in the following image.
- Before sketching, click the Construction icon on the Format panel, as shown in the following image. All geometry created will be construction until the Construction command is deselected. If you do this, remember to click the Construction icon to turn it off.

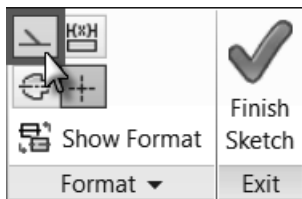

Figure 2-45

After turning the sketch into a feature, the construction geometry will be consumed with the sketch and is maintained in the sketch. When you edit a feature's sketch that you created with construction geometry, the construction geometry will reappear during editing and disappear when the part is updated. You can add or delete construction geometry to or from a sketch just like any geometry that has a normal style. In the graphics window, construction geometry will be displayed as a dashed line, lighter in color, and thinner in width than normal geometry. The following image on the left shows a sketch with a construction line for the angled line. The angled line has a coincident constraint applied to every endpoint that it touches. The image on the right shows the sketch after it has been extruded. Notice that the construction line was not extruded.

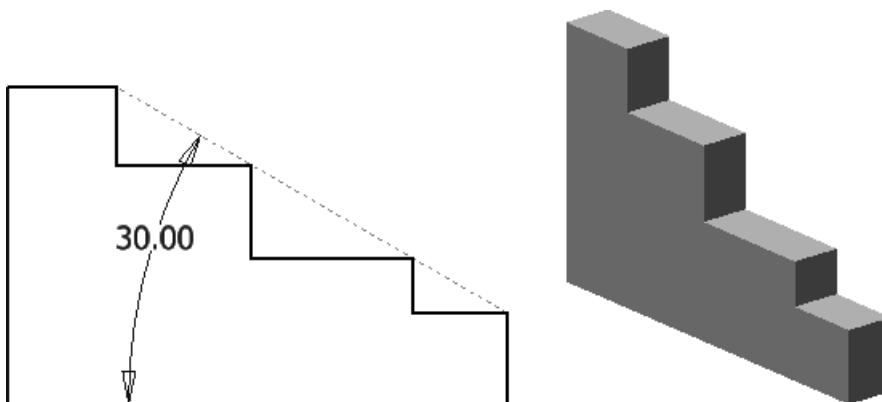

Figure 2-46

Number of Required Constraints or Dimensions

While constraining and dimensioning a sketch, there are multiple ways to determine the number of constraints or dimensions that are required to fully constrain the sketch. When you add a

constraint or dimension the number of constraints or dimensions needed to constrain the sketch decreases. A fully constrained sketch is a sketch whose geometry cannot move or stretch.

On the bottom-right corner of the status bar, the number of constraints or dimensions to fully constrain the sketch is displayed similar to what is shown in the following image on the left. When no constraints or dimensions can be added to the sketch, the message Fully Constrained will appear in the bottom-right corner of the status bar as shown in the middle image and in the browser, a pushpin icon will appear to the left of the Sketch entry as shown in the image on the right.



Figure 2-47

Degrees of Freedom

To see the areas in the sketch that are NOT constrained, you can display the degrees of freedom. While a sketch is active, click Show Degree of Freedom on the status bar, as shown in the following image on the left, or right-click in a blank area in the graphics window and click Show All Degrees of Freedom from the menu. Lines and arcs with arrows will appear as shown in the middle image. As constraints and dimensions are added to the sketch, degrees of freedom will disappear. To remove the degree of freedom symbols from the screen, click Hide All Degrees of Freedom on the bottom of the status bar, as shown in the following image on the right, or right-click in a blank area in the graphics window and click Hide All Degrees of Freedom from the menu.

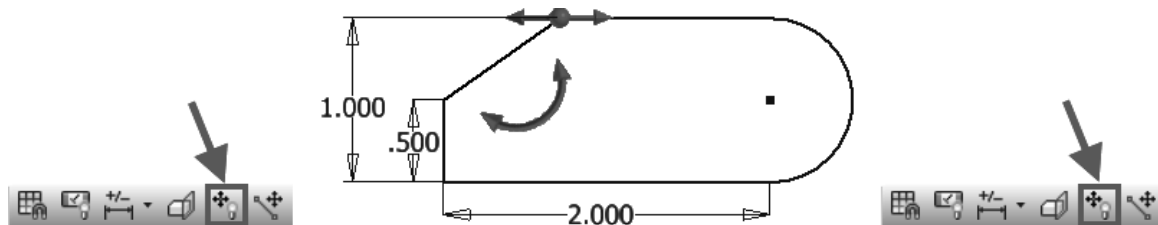

Figure 2-48

Dragging a Sketch

Another method to determine whether or not an object is constrained is to try to drag it to a new location. While not in a command, click a point or an edge, or select multiple objects on the sketch. With the left mouse button depressed, drag it to a new location. If the geometry stretches, it is under constrained. For example, if you draw a rectangle that has two horizontal and two vertical constraints applied to it and you drag a point on one of the corners, the size of the rectangle will change, but the lines will maintain their horizontal and vertical behaviors. If dimensions are set on the object, they will prevent the object from stretching.

EXERCISE 2-3: ADDING AND DISPLAYING CONSTRAINTS

In this exercise, you add geometric constraints to sketch geometry to control the shape of the sketch.

1. Click the New command, click the English folder, and double-click Standard (in).ipt.
2. Click the Start 2D Sketch command on the 3D Model tab > Sketch panel and then select the XY origin plane.

3. Sketch the geometry as shown in the following image, with an approximate size of **2 inches** in the X (horizontal) direction and **1 inch** in the Y (vertical) direction. Do not apply dimensions dynamically. Place the lower-left corner of the sketch on the origin point. Right-click in the graphics window, and then click OK. By starting the line at the origin point, that point is constrained to the origin with a coincident constraint.
4. Click Show All Constraints on the Status Bar, or press the F8 key. Your screen should resemble the following image.

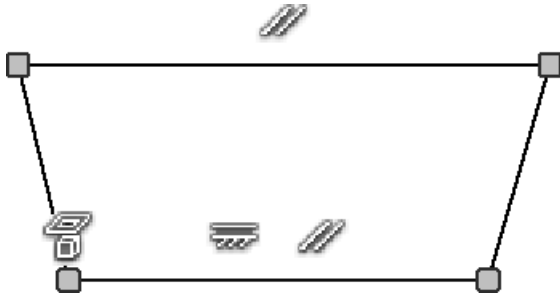

Figure 2-49

5. If another constraint appears, place the cursor over it, right-click, and then click Delete from the marking menu.
6. On the Constrain panel, click the Parallel constraint icon.
7. Select the two angled lines. Depending upon the order in which you sketched the lines, the angles may be opposite of the following image on the left. The constraints that are applied are previewed.
8. Press the ESC key twice to stop adding constraints.
9. The new constraints you just added are not displayed. Press the F8 key to refresh the visible constraints. Your screen should resemble the following image.



Figure 2-50

10. Select the top horizontal line in the sketch and drag the line. Notice how the sketch changes its size, but not its general shape. Try to drag the bottom horizontal line. The line cannot be dragged as it is constrained.
11. Select the endpoint on the bottom-right horizontal line, and drag the endpoint. The lines remain parallel due to the parallel constraints.
12. Place the cursor over the icon for the parallel constraint on the right-angled line, right-click, and click Delete from the marking menu as shown in the following image on the left. The parallel constraint that was applied to both angled lines is deleted.
13. On the Sketch Tab > Constrain panel, click the Perpendicular constraint icon.
14. Select the bottom horizontal line and the angled line on the right side. Even though it may appear that the rectangle is fully constrained, the left vertical line is still unconstrained

and can move. Notice on the bottom-right of the Status Bar that 3 dimensions are needed to fully constrain the sketch.

15. While still in the Perpendicular Constraint command, select the bottom horizontal line and the left vertical line and then right-click and click OK on the marking menu. Notice on the bottom-right the Status Bar is down to 2 dimensions to fully constrain the sketch. Dimensions would be added to fully constrain the sketch.
16. Press the F8 key to refresh the visible constraints. Your screen should resemble the following image on the right.

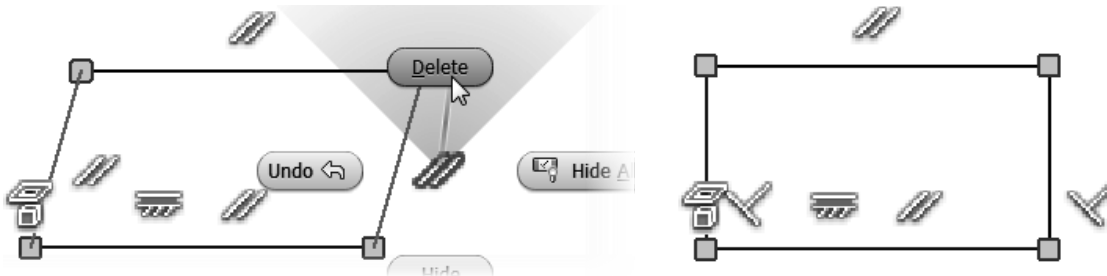

Figure 2-51

17. Click Hide All Constraints on the Status Bar, or press the F9 key.
18. Drag the point at the upper-right corner of the sketch to verify that the rectangle can change size in both the horizontal and vertical directions, but its shape is maintained.
19. Press down the CTRL key and select the four lines or use the window selection technique to select the four lines. Right-click and click Delete from the marking menu.
20. Use the Line command to sketch the geometry as shown in the following image with an approximate size of **2 inches** in the X direction and **1.375 inches** in the Y direction. Place the lower-left point of the sketch on the projected center point. Do not apply dimensions dynamically. Right-click in the graphics window, and then click OK.

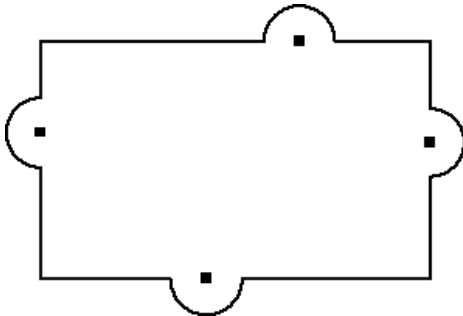



Figure 2-52

21. Inspect the constraints by dragging different points and edges.
22. Next you make the arcs equal in size. On the Constrain panel, click the Equal constraint command or press the = key on the keyboard.
 - a. Select the arc on the left and the bottom arc.
 - b. Select the arc on the left and the arc on the right side.
 - c. Select the arc on the left and the arc on the top.
23. Next you align the line segments if necessary. On the Constrain panel, click the Collinear constraint command.

Note, if the endpoints and center point of the arcs are aligned horizontally  or

vertically  when they were sketched, you will receive a message “Adding this constraint will over-constrain the sketch.” If you see this message click Cancel in the dialog box for steps 23 a. b. c. and d.

- a. Select the two bottom horizontal lines.
 - b. Select the two top horizontal lines.
 - c. Select the two left vertical lines.
 - d. Select the two right vertical lines.
24. To stop applying the collinear constraint, either right-click and click Cancel (ESC) from the marking menu or press the ESC key.
25. Next you will align the top and bottom arcs vertically. On the Constrain panel, click the Vertical constraint command.
- a. Select the center point of the bottom arc, and then click the center point of the top arc.
26. Next you will align the top and bottom arcs horizontally. On the Constrain panel, click the Horizontal constraint command.
- a. Click the center point of the left arc, and then click the center point of the right arc.
 - b. To stop applying the constraints, right-click and click Cancel (ESC) from the marking menu, or press the ESC key.
27. If desired you can move the arcs by clicking and dragging on them.
28. Display all of the constraints by pressing the F8 key. Your screen should resemble the following image.

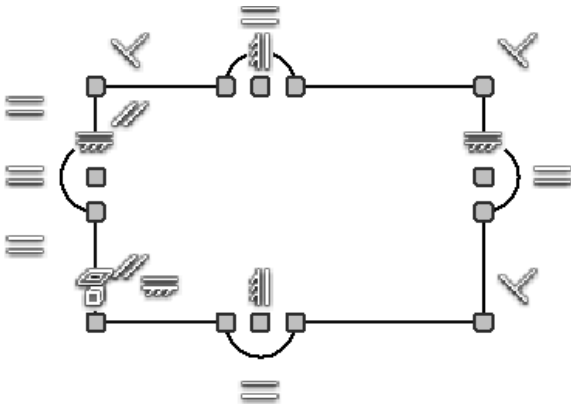

Figure 2-53

29. Hide all of the constraints by pressing the F9 key.
30. Click on an endpoint in the sketch and drag the endpoint. Try dragging different points, and notice how the sketch changes.
31. Next you delete the geometry as shown in the following image on the left. Press the ESC key twice to cancel any command, click a point above and to the left of the top arc, drag a window so it encompasses the arc on the right, release the mouse button, and press the Delete key on the keyboard.
32. Close the open line segments. Drag the open endpoints onto each other until your sketch resembles the following image on the right. A green circle will appear when the two endpoints are near each other; this applies a coincident constraint.

Note, you can close an open profile by using the Extend command on the Sketch tab > Modify panel.

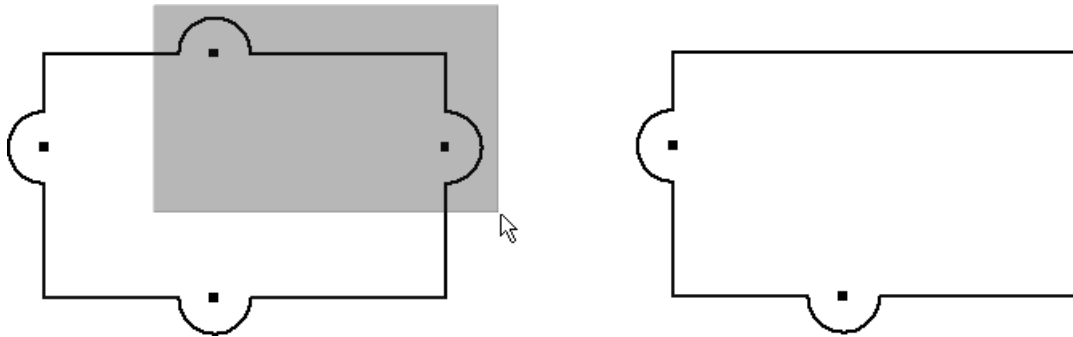

Figure 2-54

33. Next you center the arcs in the middle of the sketch. On the Constrain panel, click the Vertical constraint command.
34. Click the center point on the bottom arc and the midpoint of the top horizontal line as shown in the following image on the left.
35. On the Constrain panel, click the Horizontal constraint command.
36. Click the center point on the left arc and the midpoint of the right vertical line as shown in the following image on the right.

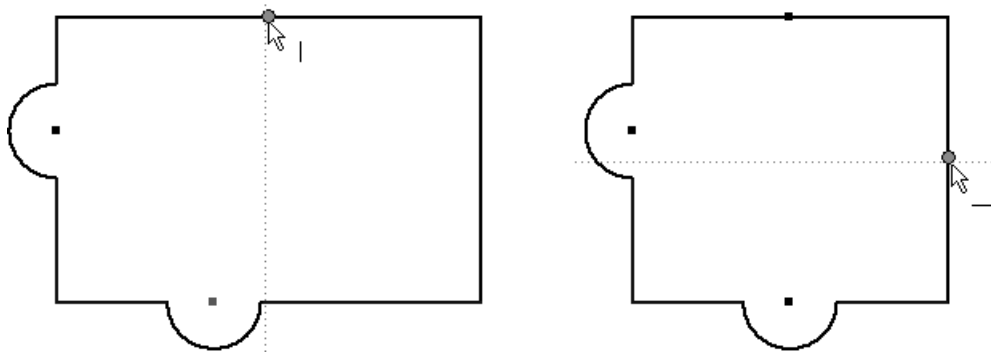

Figure 2-55

37. Click on different points and drag them, notice how the sketch changes shape, but the arcs are always centered as shown in the following image.

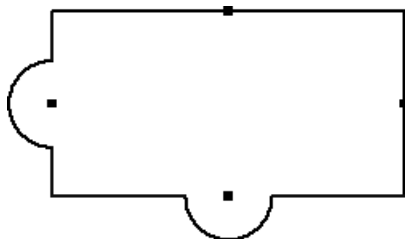

Figure 2-56

38. Close the file. Do not save changes. End of exercise. Note that dimensions would be added to fully constrain the sketch. Dimensions are covered in the next section.

STEP 3 — ADDING DIMENSIONS MANUALLY

The last step to constraining a sketch is to add dimensions that were not added dynamically. The dimensions you place will control the size of the sketch and can also appear in the part drawing views when they are generated. When placing dimensions, try to avoid having extension lines go through the sketch, as this will require more clean up when drawing views are generated. Click near the side from which you anticipate the dimensions will originate in the drawing views.

All dimensions that you create are parametric as well as the dynamic dimensions that are placed automatically when sketching geometry. Parametric means that they will change the size of the geometry.

Scale Sketch

If the sketch is not constrained to the origin point and no dimension was dynamically added to the sketch when it was created, then the entire sketch will be uniformly scaled when the first dimension is added.

General Dimensioning

The General Dimension command can create linear, angle, radial, or diameter dimensions one at a time. The following image on the left shows an example of a dimensioned sketch. To start the General Dimension command, follow one of these techniques:

- Click the General Dimension command from the Sketch tab > Constrain panel as shown in the following image in the middle.
- Right-click in the graphics window and click General Dimension from the marking menu as shown in the image on the right.
- Press the shortcut key D.

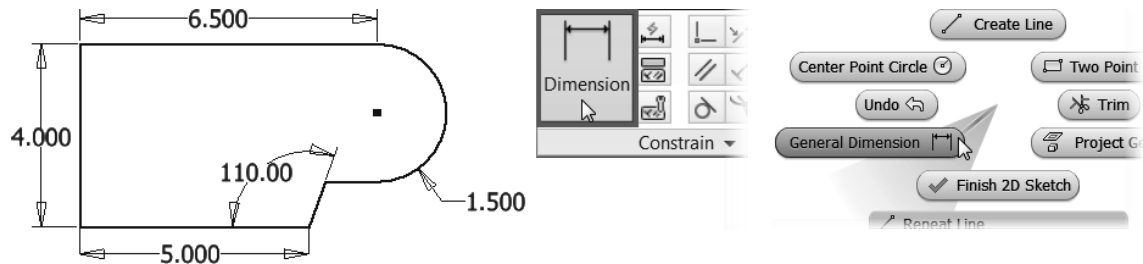

Figure 2-57

When you place a linear dimension, the extension line of the dimension will snap automatically to the nearest endpoint of a selected line; when an arc or circle is selected, it will snap to its center point. To dimension to a tangent point of an arc or circle, see “Dimensioning to a Tangent of an Arc or Circle,” later in this chapter.

After you select the General Dimension command, follow these steps to place a dimension:

1. Select the geometry to be dimensioned.
2. After selecting the geometry, a preview image will appear attached to your cursor showing the type of dimension. If the dimension type is not what you want, right-click, and then select the correct style from the menu. After changing the dimension type, the dimension preview will change to reflect the new style.
3. Click to place the dimension.
4. Enter a value for the dimension.

The next sections cover how to dimension specific objects and how to create specific types of dimensioning with the Dimension command.

Dimensioning Lines

There are multiple techniques for dimensioning a line. Issue the Dimension command and do one of the following:

- Click near two endpoints, move the cursor until the dimension is in the correct location, and click.
- To dimension the length of a line, click anywhere on the line; the two endpoints will be selected automatically. Move the cursor until the dimension is in the correct location and click.
- To dimension between two parallel lines, click one line and then the next, and then click a point to locate the dimension.
- To create a dimension whose extension lines are perpendicular to the line being dimensioned, click the line and then right-click. Click Aligned from the menu, and then click a point to place the dimension.

Dimensioning Angles

To create an angular dimension, issue the General Dimension command, click on two lines whose angle you want to define, move the cursor until the dimension is in the correct location, and place the dimension by clicking on a point.

Dimensioning Arcs and Circles

To dimension an arc or circle, issue the General Dimension command, click on the circle's circumference, move the cursor until the dimension is in the correct location, and click. By default, when you dimension a circle, the default is a diameter dimension; when you dimension an arc, the result is a radius dimension. To change a radial dimension to diameter or a diameter to radial, right-click before you place the dimension and select the other style from the Dimension Type menu.

You can dimension the angle of the arc. Start the Dimension command, click on the arc's circumference, click the center point of the arc, and then place the dimension or click the center point and then click the circumference of the arc.

For arcs you can also add an arc length dimension by starting the dimension command: click on the arc, right-click and click Arc Length from the Dimension Type menu, and then click a point to locate the dimension.

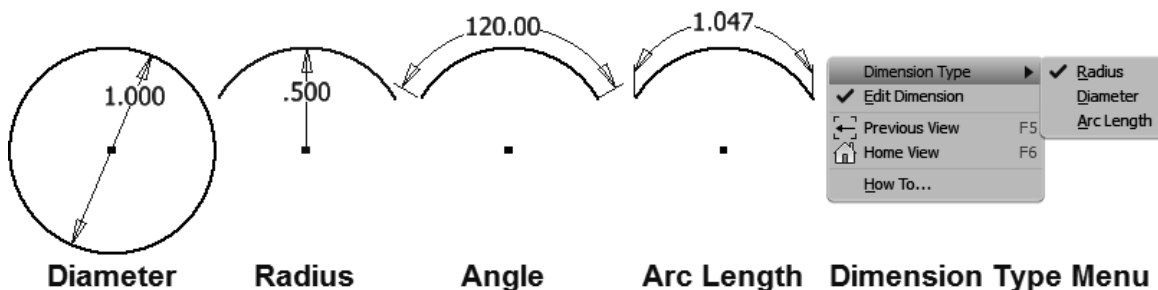

Figure 2-58

Dimensioning to a Tangent of an Arc or Circle

To dimension to a tangent of an arc or circle, follow these steps:

1. Start the General Dimension command.
2. Select a line that is parallel to the tangent arc or circle that will be dimensioned, labeled (1) in the following image on the left.
3. Move the cursor over the arc or circle until the tangent constraint symbol labeled (2) in the following image on the left.
4. Then move the cursor until the dimension is in the correct location and click to create the dimension, labeled (3) in the following image on the right.

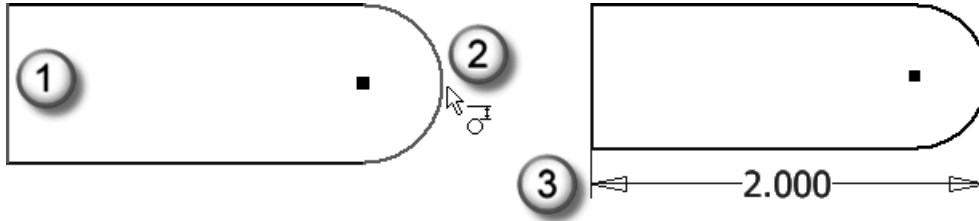

Figure 2-59

To dimension to two tangents, follow these steps:

1. Start the General Dimension command.
2. Select an arc or circle that includes one of the tangents to which it will be dimensioned. The following image illustrates an example of dimensioning a slot, the first selection is labeled (1).
3. Move the cursor over a second arc or circle until the tangent constraint symbol appears, as shown in the following image on the left, labeled (2).
4. Click to select the tangent point and then move the cursor until the dimension is in the correct location. Then click to create the dimension, labeled (3) in the following image on the right.

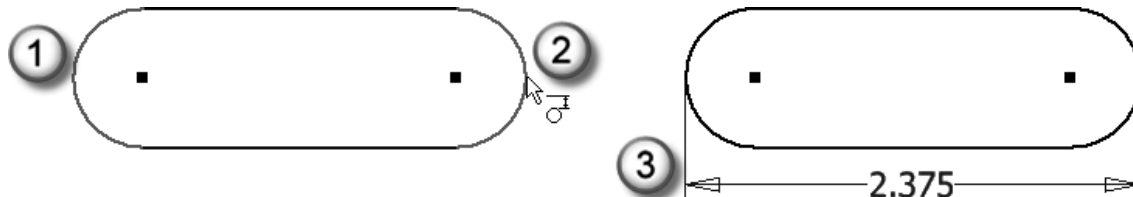

Figure 2-60

Entering and Editing a Dimension Value

After placing the dimension, you can change its value. Depending on your setting for editing dimensions when you created them, the Edit Dimension dialog box may or may not appear automatically after you place the dimension. To set the Edit Dimension option, do one of the following:

- Click the Tools tab > Options panel > Application Options. On the Sketch tab of the Application Options dialog box, from the Constrain Settings area, click the Settings button and then click the box next to Edit dimension when created as shown in the following image on the left.
- Or set this option by right-clicking in the graphics window while placing a dimension and click Edit Dimension from the menu as shown in the following image on the right. This method will change the application option Edit Dimension when created as previously described.

If the Edit dimension when created option is checked, the Edit Dimension dialog box will appear automatically after you place the dimension. Otherwise, the dimension will be placed with the default value.



Figure 2-61

To edit a dimension that has already been created, double-click on the dimension, and the Edit Dimension dialog box will appear, as shown in the following image. Enter the new value and unit for the dimension; then either press ENTER or click the checkmark in the Edit Dimension dialog box. If no unit is entered, the units that the file was created with will be used. When inputting values, enter the exact value — do not round up or down. The accuracy of the dimension that is displayed in a sketch is set in the Document Setting. For example, if you want to enter 4 1/16 decimally enter 4.0625 not 4.06.

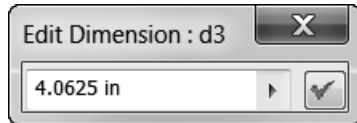

Figure 2-62

Fractions

Inventor also allows you to enter a fraction anywhere a value is required. When the Length unit in the Tools tab > Options panel > Document Settings > Units tab is set to any non-metric unit, as shown in the following image on the left, and a fraction is entered, a fraction will display in the graphics window and will be maintained in the Edit Dimension dialog box. If the Length unit is set to a metric unit and a fraction is entered, the decimal equivalent will be displayed in the graphics window but the fraction will be maintained in the Edit Dimension dialog box. After inputting a fraction you can click on the right-faced arrow and set the type of dimension to display: Decimal, Fractional, or Architectural as shown in the middle of the following image. When entering fractions do not use a dash to separate the fraction, just add a space. For example, enter 4 1/16, not 4-1/16, because Inventor would interpret the — as part of an equation and would return the value 3.9375. The following image on the right shows the fraction displayed in the graphics window.

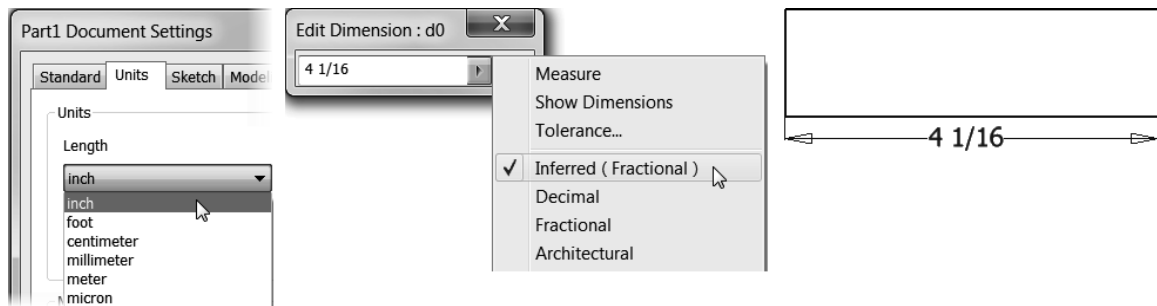



Figure 2-63



TIP: When placing dimensions, it is recommended that you place the smallest dimensions first. This will help prevent the geometry from flipping in the opposite direction.

Repositioning a Dimension

Once you place a dimension, you can reposition it, but the origin points cannot be moved. Follow these steps to reposition a dimension:

1. Exit the current operation either by pressing ESC twice or right-clicking and then clicking Cancel (ESC) from the marking menu.
2. Move the cursor over the dimension until the move symbol  appears as shown in the following image.
3. With the left mouse button depressed, move the dimension to a new location and release the button.

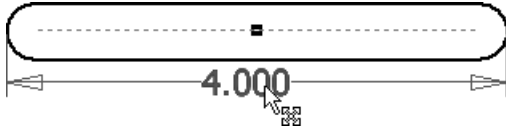

Figure 2-64

Fully Constrained Sketch

As was described in the “Constraining the Sketch” section, as you add constraints and dimensions to a sketch, the number of required dimensions is decreased. When no more constraints or dimensions are needed to constrain the sketch, the number in the “dimensions needed” section on the bottom-right of the status bar will display Fully Constrained as shown in the following image on the left. The icon to the left of the Sketch entry in the browser will also display a pushpin when the sketch is fully constrained as shown in the following image on the right.

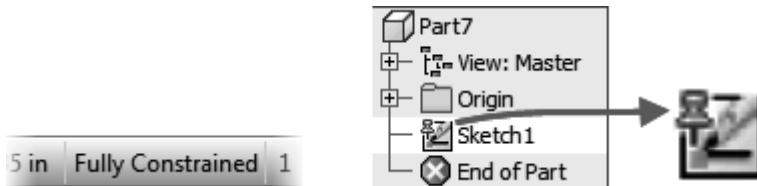

Figure 2-65

Over Constrained Sketch

As explained in the “Adding Constraints” section, Autodesk Inventor will not allow you to over-constrain a sketch or add duplicate constraints. The same is true when adding dimensions. If you add a dimension that will conflict with another constraint or dimension, you will be warned that this dimension will over-constrain the sketch or that it already exists. You can either cancel the operation and no dimension will be placed, or accept the warning and a driven dimension will be created.

A driven dimension is a reference dimension. It is not a parametric dimension—it reflects the size of the points to which it is dimensioned. If the part changes, the driven dimension will update to reflect the new value. A driven dimension will appear with parentheses around the dimensions value—for example, (2.500). When you place a dimension that will over-constrain a sketch, a dialog box will appear similar to the following image.

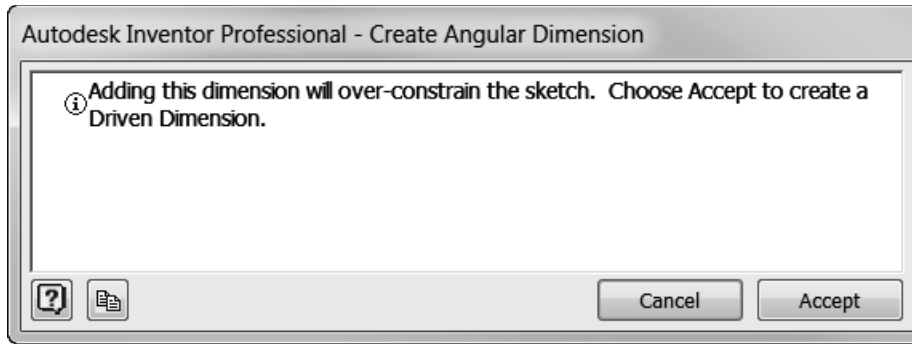

Figure 2-66

Relax Mode

When you try to place a constraint or add a dimension and you receive the over constraint message, and if you want the constraint or dimension to take precedence, you can turn on relax mode. When relax mode is on and you reapply the constraint or add the dimension, it will be applied or created and the conflicting constraint will automatically be deleted, except for Coincident, Smooth, Tangent, Symmetry, Pattern, and Project constraints, and any conflicting dimension will become a driven dimension. While in relax mode, and you are not able to add the new constraint or dimension, you may need to manually delete one of the Coincident, Smooth, Tangent, Symmetry, Pattern, and Project constraints.

Turn on relax mode by clicking the Relax Mode icon on the Status Bar as shown in the following image on the left, or click the Constrain Settings command on the Sketch tab > Constrain panel as shown in the middle image, then from the Relax Mode tab check Enable Relax Mode. When you apply a constraint or dimension that would have over constrained a sketch, a dialog box will appear stating that a constraint or dimension will be deleted to solve the conflict as shown in the following image on the right.

Another method to remove conflicting constraints or dimensions is to drag a point or edge while in Relax Mode and conflicting constraints or dimensions will be deleted.

When done editing the constrained sketch, turn off relax mode. If relax mode is left on, a constrained sketch can inadvertently be altered by dragging constrained objects.

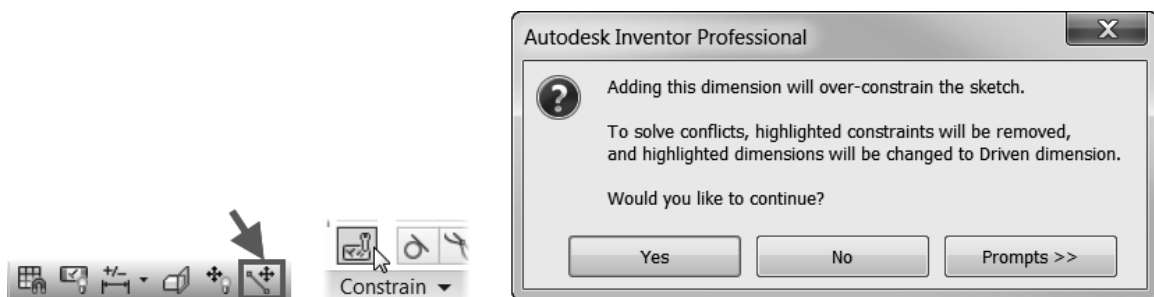

Figure 2-67

For illustration, the following image on the left shows a fully constrained rectangle with the geometric constraints visible. Relax Mode was turned on, and a 120 degree angle dimension was located. After clicking Yes in the warning dialog box the dimension was created, and the perpendicular constraint in the lower-right corner was deleted as shown in the middle image. To return the geometry back to a rectangle, a perpendicular constraint was applied to the bottom horizontal line and left vertical line and the 120 degree dimension was automatically changed to a driven dimension as shown in the image on the right.

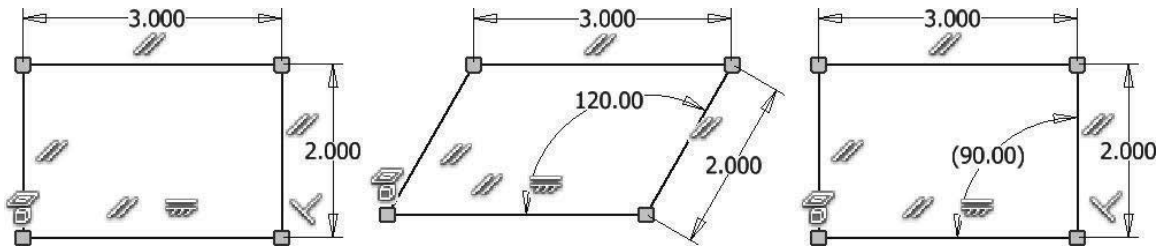

Figure 2-68



TIP: When done editing the constrained sketch turn off Relax Mode. This returns Inventor to its original editing state. If this is not done, sketches can accidentally be changed by dragging points and objects in the sketch.

Driven Dimension

Another option for creating driven dimensions is to use the Driven Dimension option. A driven dimension does NOT reduce the number of dimensions needed to constrain the sketch; it only reflects the length of the object. You would use this option to show reference dimensions.

If you select the Driven Dimension icon from the Sketch tab > Format panel, as shown in the following image on the left, any dimension you create will be a driven dimension. Driven dimensions are represented in the sketch with parentheses around the value, whereas parametric dimensions do not have parenthesis around the value. If the Driven Dimension option is not active, regular parametric dimensions will be created, which is the default.

The same Driven Dimension option can be used to change an existing dimension to either a driven dimension or back to a normal dimension by selecting the dimension and clicking the Driven Dimension option. The following image on the right shows an example of a 5.250 driven dimension referencing the overall length of the sketch. The three parametric dimensions control the length of the sketch. If one of the parametric dimension values change, the driven dimension's value will update to reflect the new overall length.

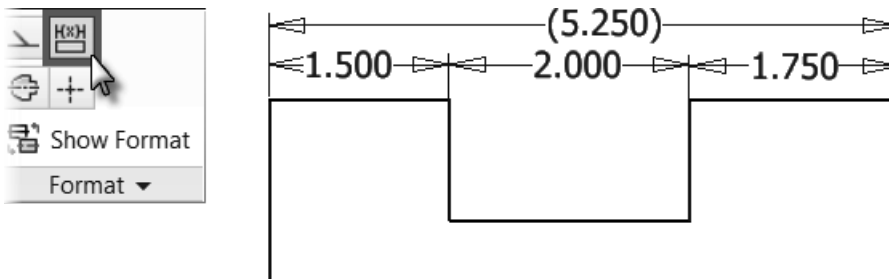

Figure 2-69



TIP: Avoid over using driven dimensions as they do not parametrically control the size of the sketch, they are only used for reference.

EXERCISE 2-4: CONSTRAINING AND DIMENSIONING A SKETCH

In this exercise, you add dimensional constraints to a sketch. Note: this exercise assumes that the “Edit dimension when created” and “Autoproject part origin on sketch create” options are

checked in the Application Options dialog box under the Sketch tab. Experiment with Autodesk Inventor’s color schemes to see how the sketch objects change color when they are constrained.

1. Click the New command and click the English folder, and then double-click Standard (in).ipt.
2. Click the Start 2D Sketch command on the 3D Model tab > Sketch panel and then select the XY origin plane.
3. Start sketching by starting the line command in the Sketch tab > Create panel and click the origin point, move the cursor to the right, type **5** in the distance input field, press the Tab key, and then click a point when the horizontal constraint is previewed above the input field for degrees as shown in the following image on the left.
4. Next you place an angle line and a dynamic dimension to define the angle. Press the tab key and type **150** for the angle input field, press the Tab key, and then click a point to the upper right as shown in the following image on the right. The distance should be about 2 inches but the dimension is not needed to define this sketch.

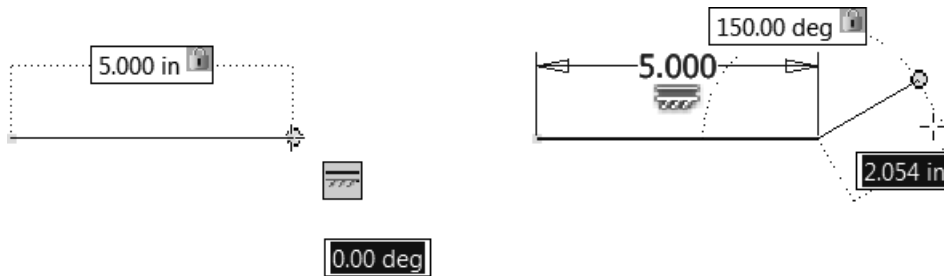

Figure 2-70

5. Sketch the geometry as shown in the following image. When sketching, ensure that a perpendicular constraint is not applied between the two angled lines. If needed, hold down the CTRL key while sketching the top angle line to prevent sketch constraints from being applied. The arc should be tangent to both adjacent lines.

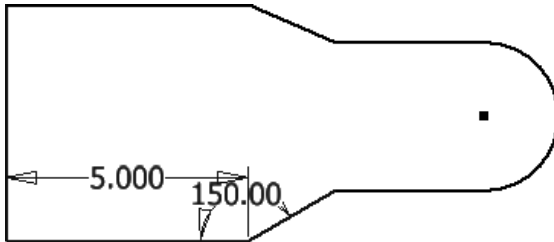

Figure 2-71

6. Add a horizontal constraint between the midpoint of the left vertical line and the center of the arc by clicking the Horizontal Constraint command from the Sketch tab > Constrain panel and select the midpoint of the line and the center point of the arc as shown in the following image on the left.
7. Start the Vertical Constraint command from the Sketch tab > Constrain panel and add a vertical constraint between the endpoints of the angled lines nearest to the right side of the sketch as shown in the following image on the right.

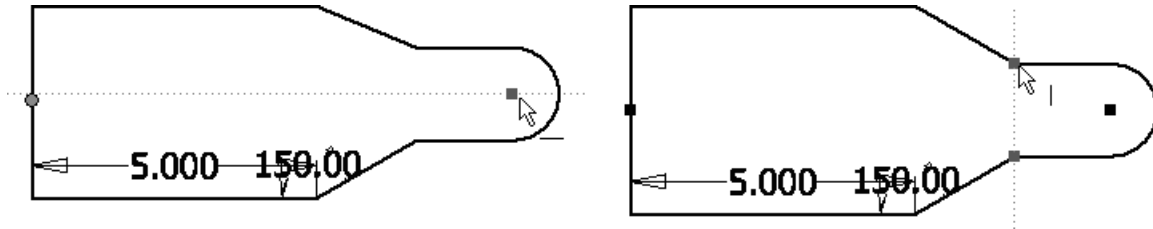

Figure 2-72

8. Make the two angled lines equal in length by adding an equal constraint, press the = key and then select the two angled lines.
9. Click the General Dimension command in the Sketch tab > Constrain panel and add a radial dimension by selecting the arc. Move the cursor until the dimension is positioned near the lower right corner of the sketch, then click a point and enter **1.5** for its value (if the Edit Dimension dialog box did not appear, double-click on the dimension and change the dimension to 1.5), and click the checkmark in the Edit Dimension dialog box.



TIP: To set the Edit Dimension dialog box to appear when placing dimensions, while placing a dimension, right-click in the graphics window and click Edit Dimension from the menu.

10. While still in the General Dimension command, add a vertical dimension by selecting the vertical line, position the dimension to the left, click a point to locate it, enter **5**, and click the checkmark. When complete, your sketch should resemble the following image on the left. Notice on the bottom right of the Status Bar, 1 dimension is required to fully constrain the sketch as shown in the following image on the right.

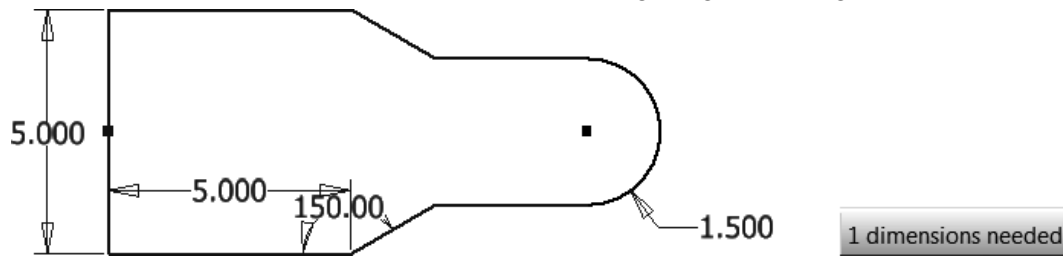

Figure 2-73

11. Add a horizontal dimension by selecting the left vertical line and then select the center point of the arc or on the top of the arc, locate the dimension to the top of the sketch and enter **10** for the value as shown in the following image.

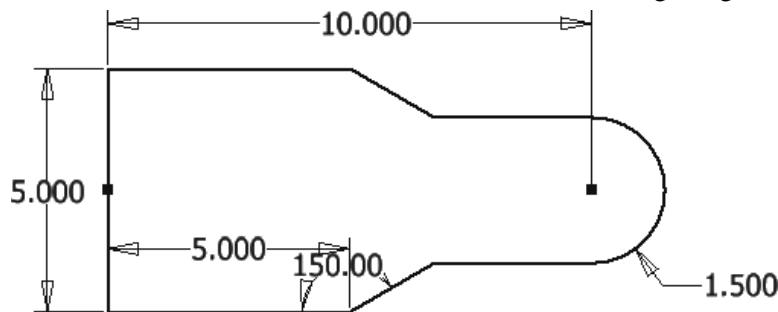

Figure 2-74

12. Press the ESC key twice to end the command. In the Status Bar, in the number of dimensions required section, it should display “Fully Constrained,” and the icon to the left of the sketch in the browser should have a pushpin on it.
13. Try to click and drag on different points on the sketch. The points will not change because they are constrained or dimensioned.
14. Turn relax mode on by clicking the Relax Mode icon in the Status Bar, as shown in the following image.



Figure 2-75

15. Click and drag on different points on the sketch. The dimensions will change to reflect their new value.
16. Return the sketch to the values shown in step 14 by using the Undo command in the Quick Access toolbar.
17. While still in Relax Mode, add an overall horizontal dimension using the General Dimension command by clicking the vertical line (not an endpoint), move the cursor near the right tangent point of the arc until the glyph of dimension with a circle appears $\overline{\circ}$, as shown in the following image on the left.
18. Locate the dimension above the 10.000 dimension.
19. Click Yes in the dialog box; that allows the highlighted dimension to be changed to a driven dimension.
20. To accept the default length of 11.500, click the green check mark in the Edit Dimension dialog box. The 10.000 was automatically changed to a driven dimension and the sketch should still be fully constrained. Your sketch should resemble the following image on the right.

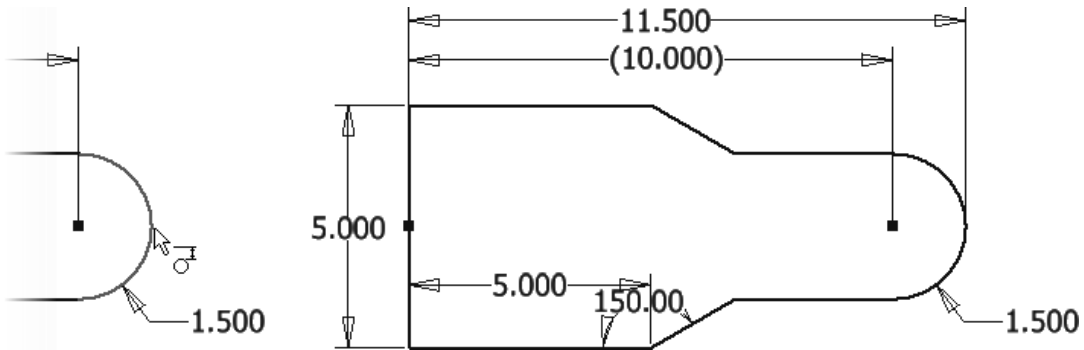

Figure 2-76

21. Edit the value of some of the sketch dimensions by double-clicking on the dimension's value, type in a new value and then press ENTER on the keyboard or click the green check mark in the Edit Dimension dialog box, and examine how the sketch changes. The arc should always be in the middle of the vertical line. Notice how the driven dimension changes when the horizontal, angle or radial dimension values change.
22. Delete the horizontal constraint between the center of the arc and the midpoint of the vertical line by selecting the center point of the arc, select the horizontal constrain above the center point, right-click and click Delete from the menu as shown in the following image.

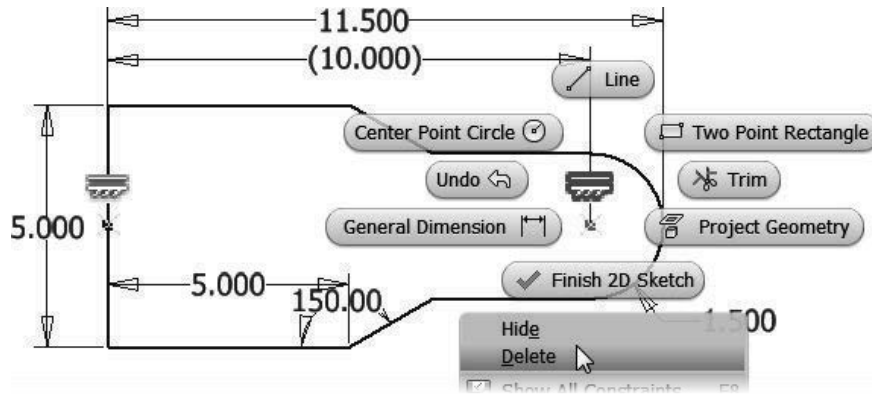

Figure 2-77

23. Turn relax mode off by clicking the Relax Mode icon in the Status Bar, as shown in the following image.

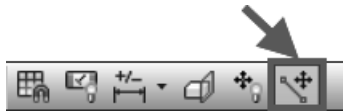

Figure 2-78

24. Display the visibility of all of the constraints by window selecting all of the geometry.
 25. Click in a blank area in the graphics window and the constraints will disappear.
 26. In the Status Bar click the Show All Constraints command, as shown in the following image, and practice deleting and adding other constraints.



Figure 2-79

27. Practice adding and deleting dimensions.
 28. Close the file. Do not save changes. End of exercise.

INSERTING AUTOCAD FILES

You may have legacy AutoCAD files or receive AutoCAD files that you need to convert into Inventor parts. In this section you learn how to insert AutoCAD data into a sketch. When importing a 2D DWG file into Autodesk Inventor, you can either copy the contents from the DWG file to the clipboard via Autodesk Inventor or AutoCAD and paste the contents into Autodesk Inventor, or use an import wizard that guides you through the process. In this section you learn how to insert AutoCAD 2D data into a sketch in an Inventor part file.



TIP: AutoCAD does not need to be installed to import AutoCAD geometry into Autodesk Inventor.

Inserting 2D AutoCAD Data into a Sketch

In this section you learn how to insert AutoCAD 2D data into the active sketch in a part or drawing. To insert AutoCAD data into the active sketch, follow these steps:

1. Start a new Inventor part file or open an existing part file.
2. Create a new sketch or make an existing sketch active.
3. Click the Insert AutoCAD File command on the Sketch tab > Insert panel as shown in the following image.

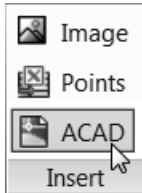

Figure 2-80

4. The Open dialog box will appear. Browse to and either double-click the desired DWG file or click on the DWG file and then click Open.

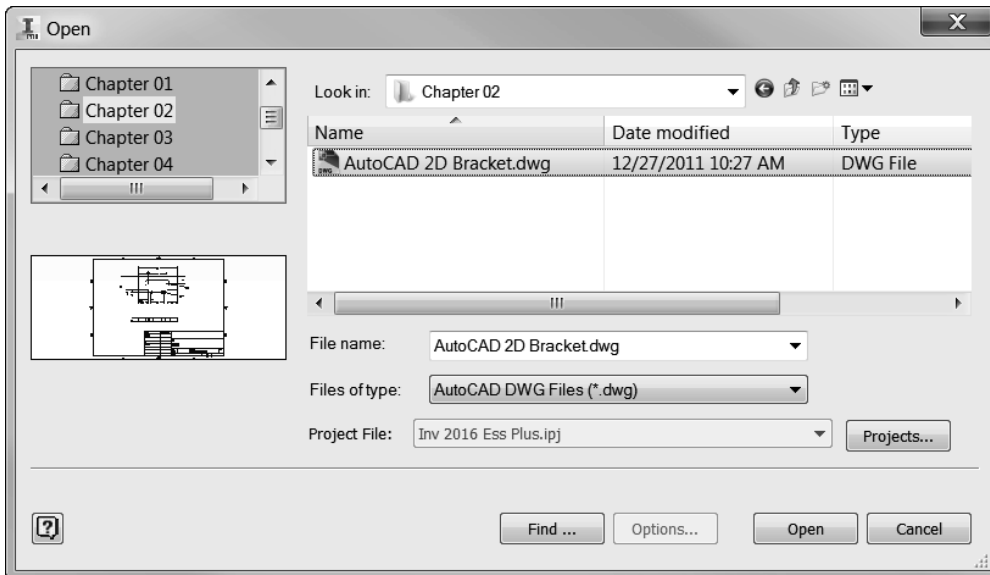

Figure 2-81

5. The Layers and Objects Import Options dialog box appears. In the Selective import section in the upper-left corner of the dialog box, uncheck the layer names you do not want data imported from as shown in the following image.
6. To select specific objects to insert, uncheck the All option, and then select the desired data in the preview window. In the preview window you can zoom and pan as needed.
7. You can change the background color of the preview image by clicking the black or white icon at the top-right corner of the dialog box.

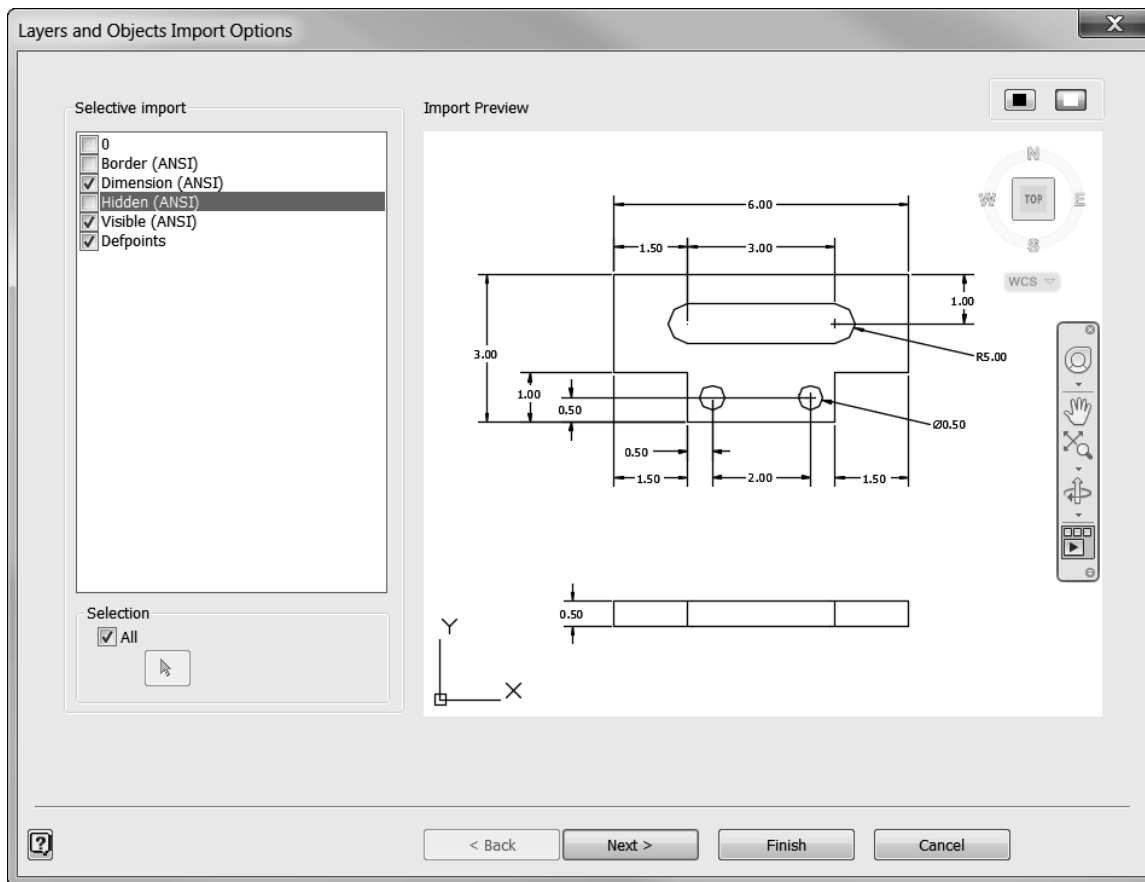

Figure 2-82

8. Click the Next button to go to the next step. In the Import Destination Options dialog box specify the units in which the data was created as shown in the following image.
9. Check the options to Constrain End Points and Apply geometric constraints as shown in the following image. The Apply geometric constraints option will add sketch constraints to geometry that is parallel, perpendicular and tangent.

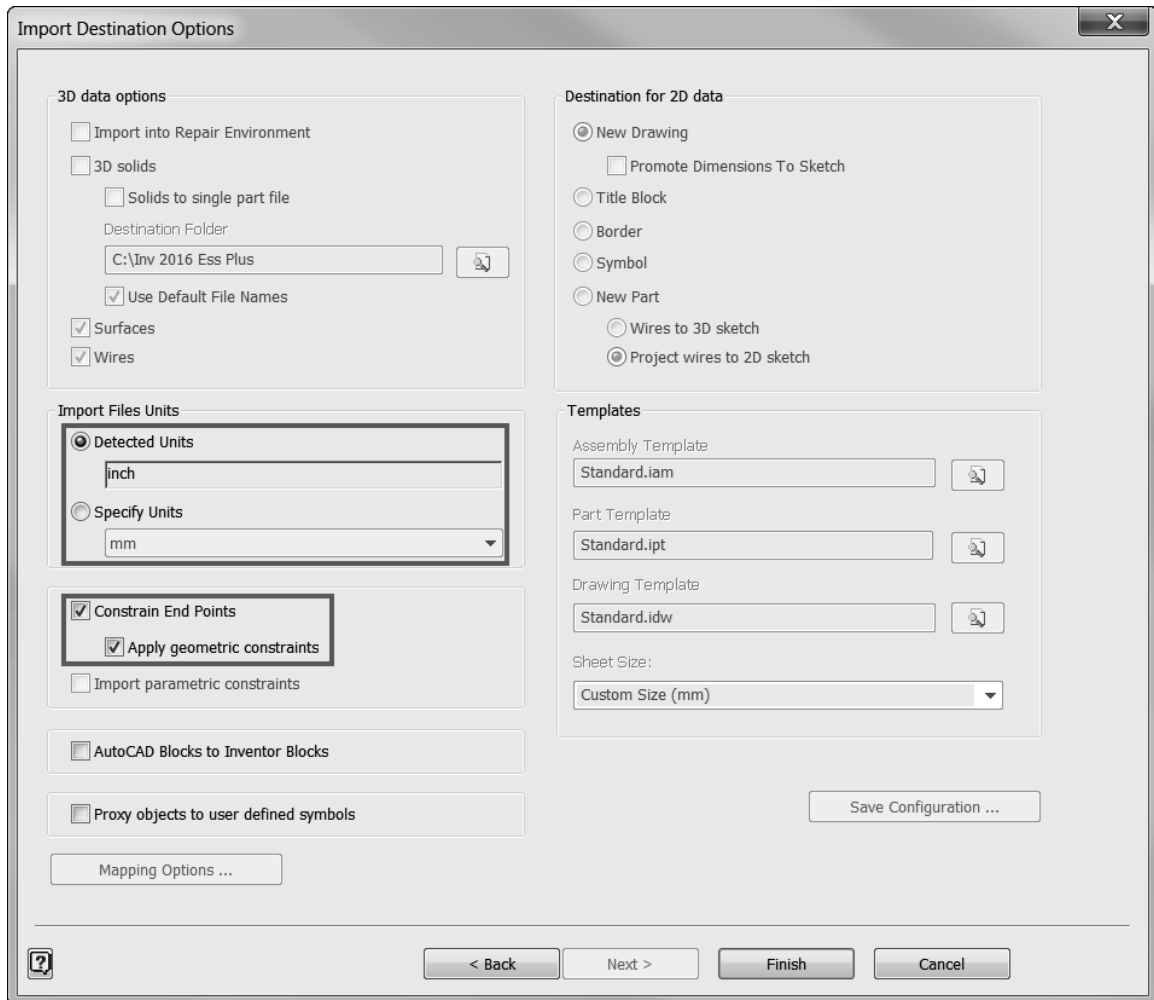

Figure 2-83

10. To import the data, click Finish.
11. Use the Zoom All command or double-click the wheel to see all the geometry.
12. Delete unnecessary geometry, constraints, and dimensions.
13. Add geometry (if needed), constraints, and dimensions to fully constrain the sketch.

Insert AutoCAD File with Associativity

If you want to import AutoCAD data as an underlay, which allows you to project the imported geometry onto a sketch, use the Import command on the Manage tab > Insert panel. If the imported AutoCAD data changes, you can update the geometry by clicking the Update command on the Quick Access toolbar.

OPEN OTHER FILE TYPES

Autodesk Inventor can also open parts and assemblies exported from other CAD systems. When files from other CAD systems are opened in Inventor, they will be imported as solids or surface models depending upon the original file and the components will NOT have feature history and an assembly will NOT have any assembly constraints. You can add features to imported parts and edit the geometry by using Inventor’s Direct Edit command. For files that are imported as an assembly, you can add assembly constraints. To open file types such as DXF, Alias, Catia, IDF

Board Files, IGES, JT, Parasolids, PRO/E, SAT, STEP, SOLIDWORKS, and Unigraphics NX, click the Inventor Application Menu > Open or click Open on the Quick Access toolbar. You can also use the Import DWG command from the Application Menu > Open; this command will import AutoCAD data into a new drawing, title block, border, symbol or part file without having to first create a new file.

In the Open dialog box, click the desired file format in the Files of type list. See the help system for more information about the different file types.

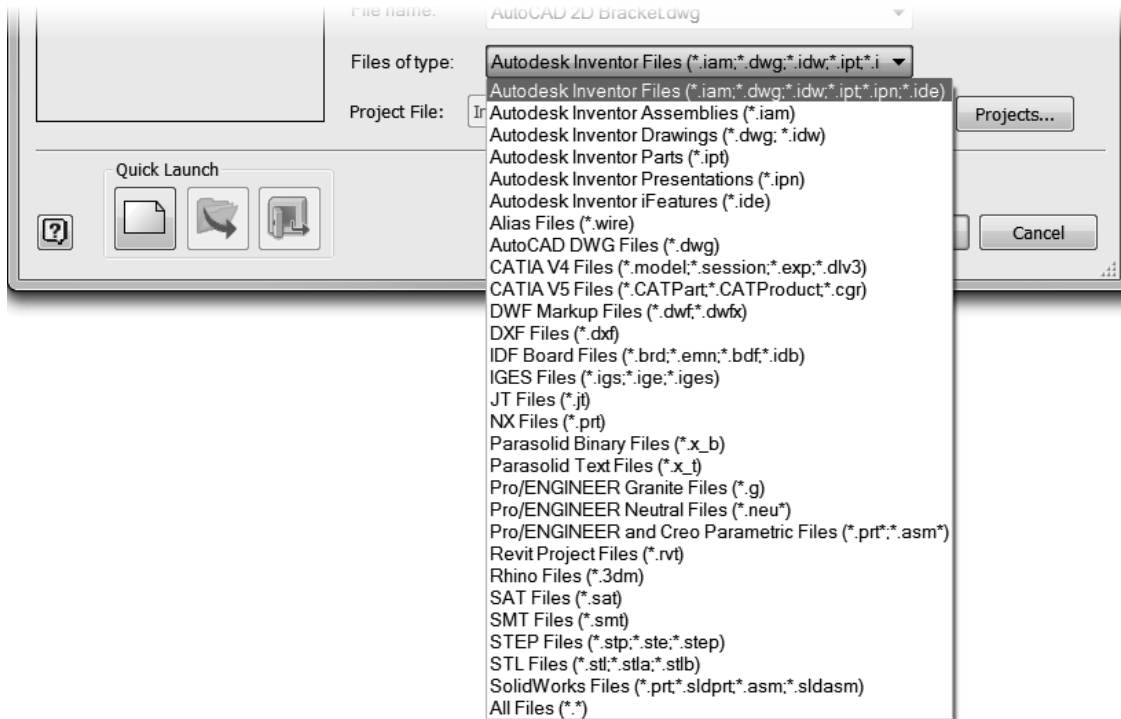

Figure 2-84

EXERCISE 2-5: INSERTING AUTOCAD DATA

In this exercise, you insert AutoCAD data into a sketch and add constraints to fully constrain the sketch.

1. Click the New command, click the English tab, and then double-click Standard (in).ipt, or if inch is the default unit, from the left side of the Quick Access toolbar you can click the down arrow of the New icon, and select Part.
2. Click the Start 2D Sketch command on the 3D Model tab > Sketch panel and then select the XY origin plane.
3. Click the Insert AutoCAD command from the Sketch tab > Insert panel.
4. From the Frequently Used Subfolder area (upper left corner of the dialog box) click the Chapter 02 subfolder and then in the file area double-click on the file *AutoCAD 2D Bracket.dwg*

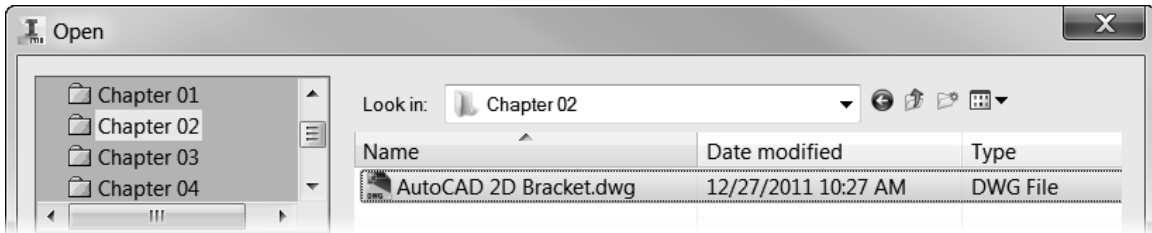

Figure 2-85

5. In the Layers and Objects Import Options dialog box you uncheck the layers that are not needed. In the upper left corner of the dialog box uncheck layers 0, Border (ANSI) and Hidden (ANSI) as shown in the following image labeled (1).
6. In the Selection area near the bottom left corner of the dialog box uncheck All, labeled (2) in the following image.
7. Select the geometry and dimensions to insert, use the window selection (click a point above and to the left of the geometry and then click a point below and to the right of the geometry) labeled (3) in the following image.

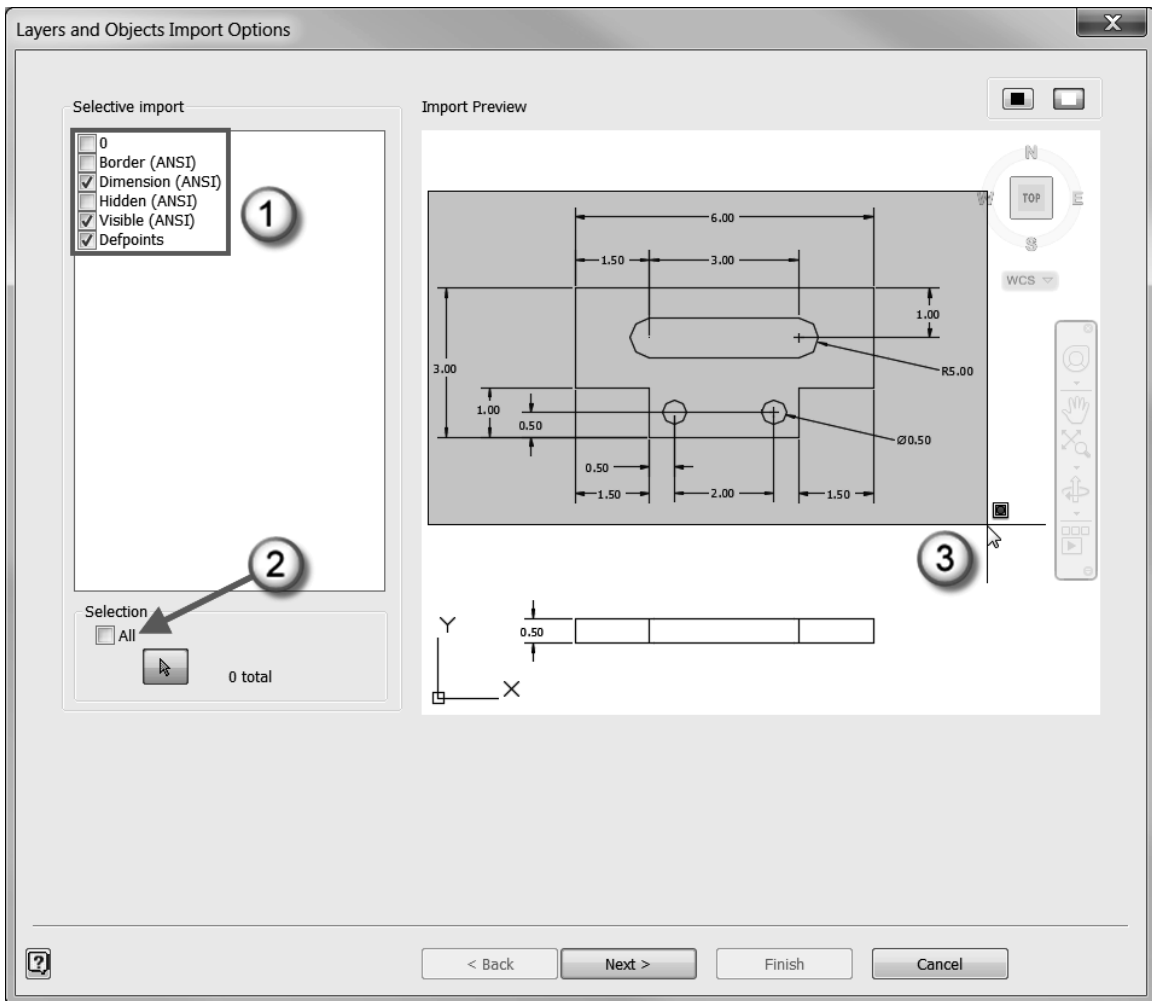

Figure 2-86

- In the Selection area of the dialog box, verify that 27 total objects are selected as shown in the following image. If not, reselect all of the data in the top view.

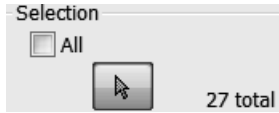

Figure 2-87

- Click the Next button on the bottom of the dialog box.
- In the Import Destination Options dialog ensure inch is set as the detected unit and check the Constrain End Points and the Apply geometric constraints options as shown in the following image.

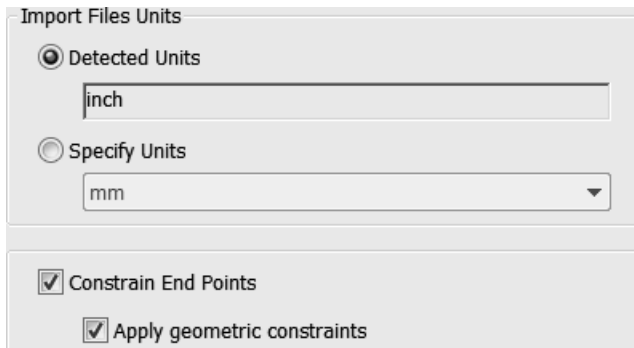

Figure 2-88

- Click the Finish button on the bottom of the dialog box.
- If needed, display all the geometry by double-clicking the wheel on the mouse.
- Apply a horizontal constraint between the center points of the two circles labeled (1) in the following image.
- Apply a collinear constraint between the two middle horizontal lines labeled (2).
- Press the ESC key twice to cancel the command.
- The sketch is free to move. To constrain the sketch, drag the lower-left corner of the sketch labeled (3) in the following image to the origin point of the sketch (0,0). Or you could add a coincident constraint between the origin point and the left point on the bottom line.

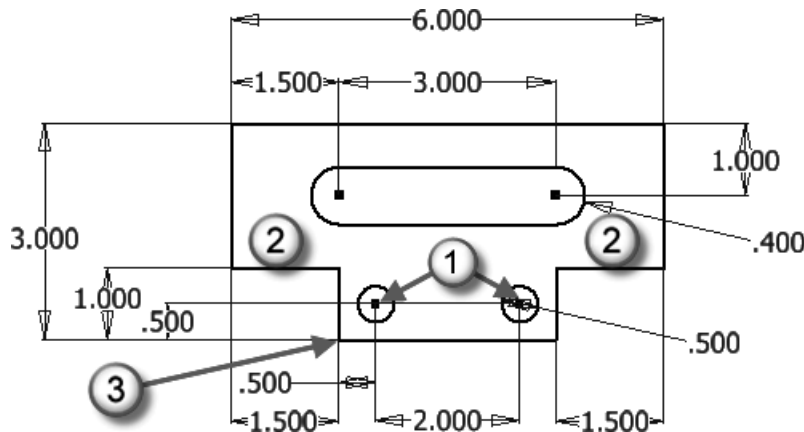

Figure 2-89

17. On the lower-right corner of the Status Bar, the text should state that “1 dimensions needed” to constrain the sketch.
18. Drag up the top-right endpoint of the top horizontal line up; the sketch will be rotated slightly as shown in the following image on the left.
19. Apply a horizontal constraint to the lower horizontal line, and this will fully constrain the sketch as shown in the following image on the right. The dimensions can be repositioned as needed.

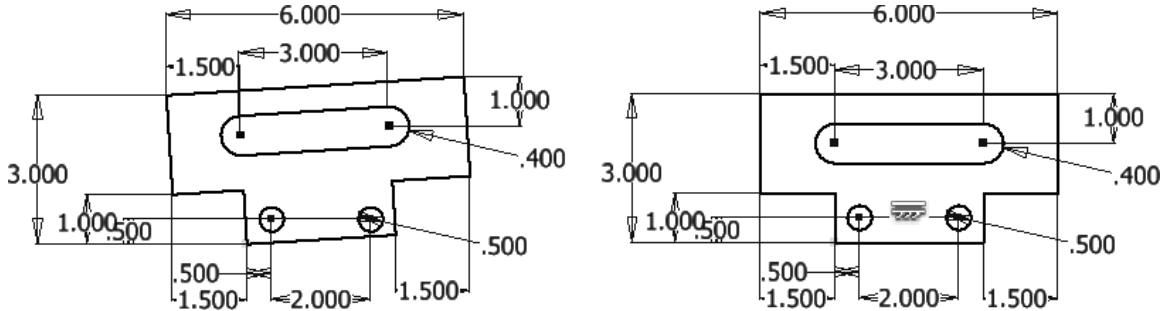

Figure 2-90

20. Press the F8 key to see all constraints.
21. Press the F9 key to hide all constraints.
22. The AutoCAD dimensions on the sketch are now parametric and can be edited. Practice editing the values of the dimensions by double-clicking on a dimension’s value and enter a new value.
23. Close the file. Do not save changes. End of exercise.

APPLYING YOUR SKILLS

Skills Exercise 2-1

In this exercise, you create a sketch and then add geometric and dimensional constraints to control the size and shape of the sketch. Start a new part file based on the Standard (in).ipt, create a sketch on the XY plane, and create the fully constrained sketch as shown in the following image. Assume that the top and bottom horizontal lines are collinear, the center points of the arcs are aligned vertically, and the sketch is symmetric about the left and right sides. The bottom angled lines should be coincident with the center point of the lower arc (if the arc is drawn via the line command, the center point of the arc will automatically be coincident with the line it was drawn from). When done, close the file and do not save the changes.

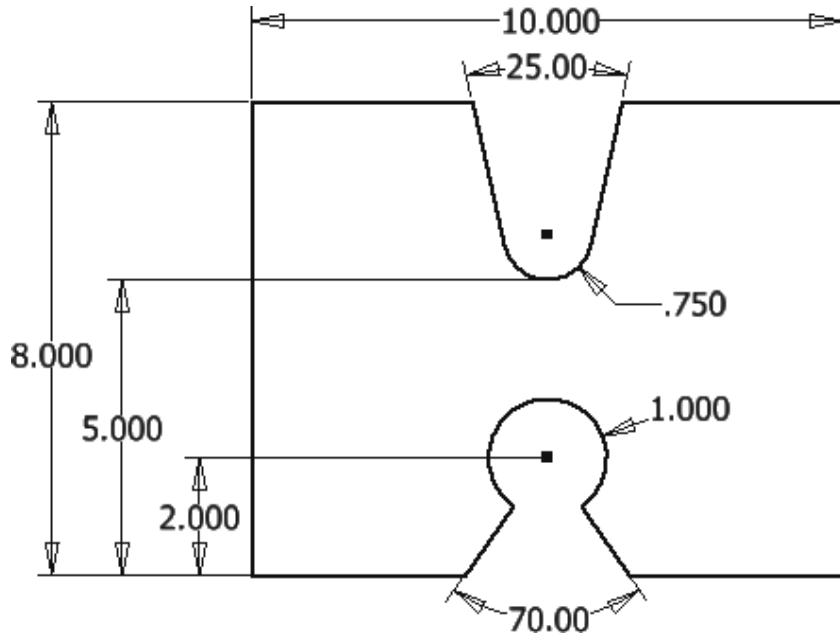

Figure 2-91

Skills Exercise 2-2

In this exercise, you create a sketch with linear and arc shapes, and then add geometric and dimensional constraints to fully constrain the sketch. Start a new part file based on the Standard (in).ipt template. Create a sketch on the XY plane, and create the fully constrained sketch as shown in the following image. First create the two circles and align their center points horizontally. Then create the two lines, and place a vertical constraint between the line endpoints on both ends. When done, close the file and do not save the changes.

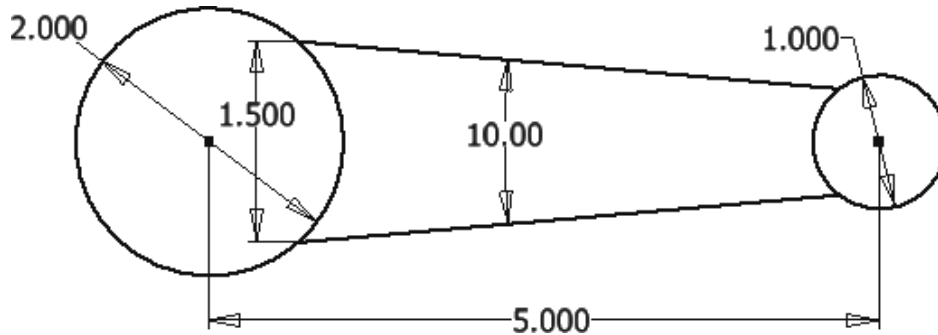

Figure 2-92

CHECKING YOUR SKILLS

Use these questions to test your knowledge of the material in this chapter.

1. True__ False__ While sketching, by default, geometric constraints are not applied to the sketch.
2. True__ False__ When you sketch and a point is inferred, a constraint is applied to represent that relationship.
3. True__ False__ It is recommended to never fully constrain a sketch.

4. True__ False__ When working on a millimeter part, you cannot input inch units.
5. True__ False__ After a sketch is fully constrained, you cannot change a dimension's value.
6. True__ False__ A driven dimension is another name for a parametric dimension.
7. True__ False__ Dimensions placed dynamically are not parametric.
8. True__ False__ You can only import 2D AutoCAD data into Autodesk Inventor.
9. Explain how to draw an arc while using the Line command.
10. Explain how to remove a geometric constraint from a sketch.
11. Explain how to change a vertical dimension to an aligned dimension while placing the dimension.
12. Explain how to create a dimension that is tangent to two arcs.
13. True__ False__ AutoCAD needs to be installed to insert AutoCAD geometry.
14. True__ False__ When a sketch is extruded that contains construction geometry, the construction geometry is deleted.
15. Explain how to change the unit type in a part file.
16. Explain where you would turn on Relax Mode.
17. True__ False__ When a pushpin appears in the Sketch entry in the browser, the sketch is fully constrained.
18. True__ False__ By default an arc length dimension can only be a driven dimension.
19. Explain how to draw a rectangle that is centered on the origin point.
20. True__ False__ When creating the first 2D sketch, you must select an origin plane to sketch on.