

# SOLIDWORKS® 2018

## Quick Start

with Video Instruction



David C. Planchard, CSWP,  
SOLIDWORKS Accredited Educator



**Better Textbooks. Lower Prices.**  
[www.SDCpublications.com](http://www.SDCpublications.com)



**ACCESS CODE**  
UNIQUE CODE INSIDE

Visit the following websites to learn more about this book:



[amazon.com](https://www.amazon.com)

[Google books](https://books.google.com)

[BARNES & NOBLE](https://www.barnesandnoble.com)

# Chapter 1

## Overview of SOLIDWORKS® 2018 and the User Interface

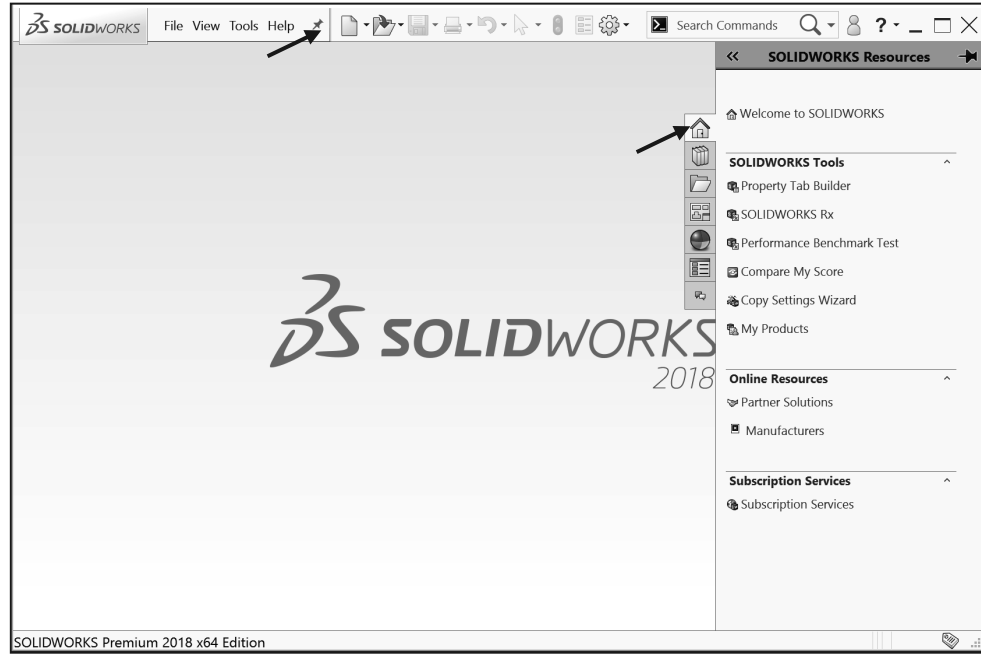

Below are the desired outcomes and usage competencies based on the completion of Chapter 1.

Desired Outcomes:	Usage Competencies:
<ul style="list-style-type: none"> <li>A comprehensive understanding of the SOLIDWORKS® 2018 User Interface (UI) and CommandManager.</li> </ul>	<ul style="list-style-type: none"> <li>Ability to establish a SOLIDWORKS session.</li> <li>Aptitude to utilize the following items: Menu bar toolbar, Menu bar menu, Drop-down menus, Context toolbars, Consolidated drop-down toolbars, System feedback icons, Confirmation Corner, Heads-up View toolbar, Document Properties, and more.</li> <li>Open a new and existing SOLIDWORKS part.</li> <li>Knowledge to zoom, rotate and maneuver a three button mouse in the SOLIDWORKS Graphics window.</li> </ul>

**Notes:**

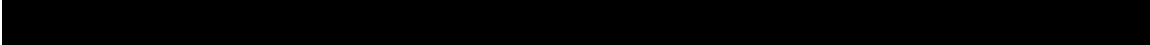

## Chapter 1 - Overview of SOLIDWORKS® 2018 and the User Interface

### Chapter Objective

Provide a comprehensive understanding of the SOLIDWORKS® default User Interface and CommandManager: Menu bar toolbar, Menu bar menu, Drop-down menu, Right-click Pop-up menus, Context toolbars/menus, Fly-out tool button, System feedback icons, Confirmation Corner, Heads-up View toolbar, and more.

On the completion of this chapter, you will be able to:

- Utilize the SOLIDWORKS Welcome dialog box.
- Establish a SOLIDWORKS session.
- Comprehend the SOLIDWORKS 2018 User Interface.
- Recognize the default Reference Planes in the FeatureManager.
- Open a new and existing SOLIDWORKS part.
- Utilize SOLIDWORKS Help and SOLIDWORKS Tutorials.
- Zoom, rotate and maneuver a three button mouse in the SOLIDWORKS Graphics window.

### What is SOLIDWORKS®?

- SOLIDWORKS® is a mechanical design automation software package used to build parts, assemblies and drawings that takes advantage of the familiar Microsoft® Windows graphical user interface.
- SOLIDWORKS is an easy to learn design and analysis tool (SOLIDWORKS Simulation, SOLIDWORKS Motion, SOLIDWORKS Flow Simulation, Sustainability, etc.), which makes it possible for designers to quickly sketch 2D and 3D concepts, create 3D parts and assemblies and detail 2D drawings.
- Model dimensions in SOLIDWORKS are associative between parts, assemblies and drawings. Reference dimensions are one-way associative from the part to the drawing or from the part to the assembly.
- This book is written for the beginner to intermediate user.

# Start a SOLIDWORKS 2018 Session

Start a SOLIDWORKS session and familiarize yourself with the SOLIDWORKS User Interface. As you read and perform the tasks in this chapter, you will obtain a sense of how to use the book and the structure. Actual input commands or required actions in the chapter are displayed in bold.

This book does not cover starting a SOLIDWORKS session in detail for the first time. A default SOLIDWORKS installation presents you with several options. For additional information, visit <http://www.SOLIDWORKS.com>.



Redeem the code on the inside cover of the book. View the provided videos and models to enhance the user experience.

**Activity: Start a SOLIDWORKS Session.**

Start a SOLIDWORKS session.

- 1) Type **SOLIDWORKS** in the Search Window.
- 2) Click **All Programs**.
- 3) Click the **SOLIDWORKS 2018** application (or if available, **double-click** the SOLIDWORKS icon on the Desktop). When you open the SOLIDWORKS software, view the Welcome dialog box. The Welcome dialog box provides a convenient means to open documents, view folders, access SOLIDWORKS resources, and stay updated on SOLIDWORKS news.
- 4) **View** your options. Do not open a document at this time.

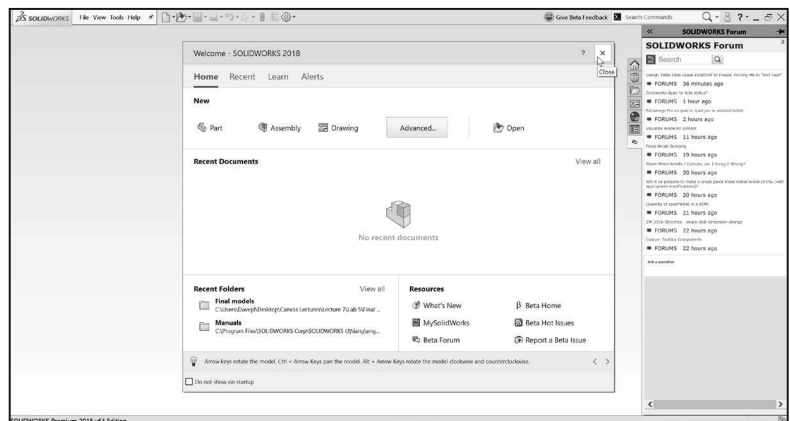
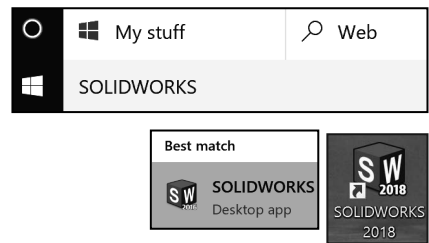

You can also click **Welcome to**



(Standard toolbar), **Help >**

**Welcome to SOLIDWORKS**, or **Welcome to SOLIDWORKS** on the SOLIDWORKS

Resources tab in the Task Pane to open the Welcome dialog box.

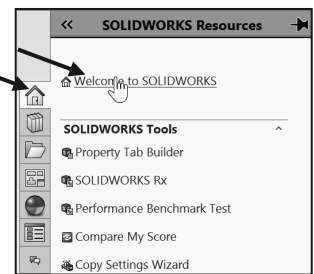
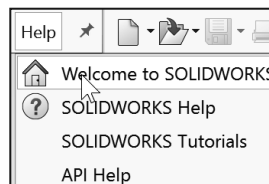

## Home Tab

The Home tab lets you open new and existing documents, view recent documents and folders, and access SOLIDWORKS resources.

Sections in the Home tab include New, Recent Documents, Recent Folders, and Resources.

## Recent Tab

The Recent tab lets you view a longer list of recent documents and folders. Sections in the Recent tab include Documents and Folders.

The Documents section includes thumbnails of documents that you have opened recently. Click a thumbnail to open the document, or hover over a thumbnail to see the document location and access additional information about the document. When you hover over a thumbnail, the full path and last saved date of the document appears.

## Learn Tab

The Learn tab lets you access instructional resources to help you learn more about the SOLIDWORKS software.

Sections in the Learn tab include:

- **Introducing SOLIDWORKS.** Opens the Introducing SOLIDWORKS book.
- **Tutorials.** Opens the step-by-step tutorials in the software.
- **MySolidWorks Training.** Opens the Training section at MySolidWorks.com.
- **Samples.** Opens local folders containing sample models.
- **3DContentCentral.** Opens 3DContentCentral.com.
- **Online Tutorials.** Opens the SOLIDWORKS Tutorials (videos) section at solidworks.com.
- **My Training.** Opens the My Training section at MySolidWorks.com.

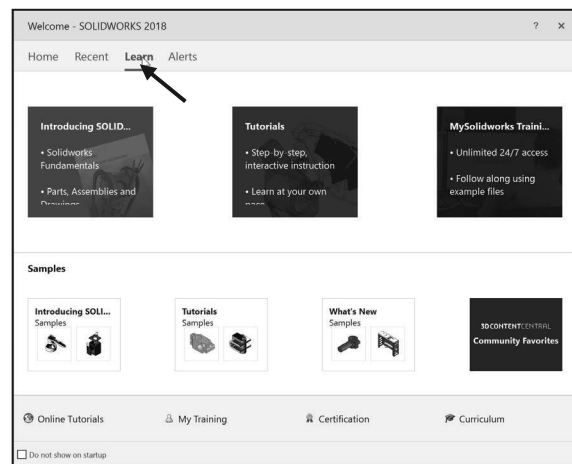
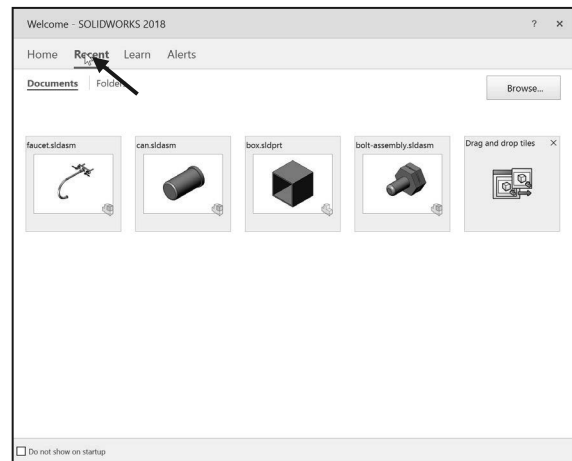
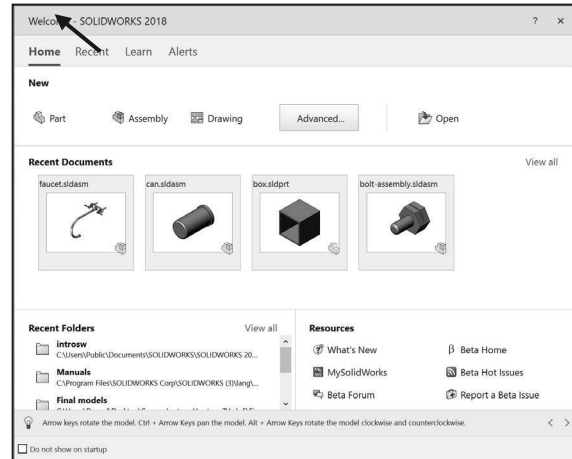

- **Certification.** Opens the SOLIDWORKS Certification Program section at [solidworks.com](http://solidworks.com).
- **Curriculum.** Opens the Curriculum section at [solidworks.com](http://solidworks.com).



When you install the software, if you do not install the Help Files or Example Files, the Tutorials and Samples links are unavailable.

## Alerts Tab

The Alerts tab keeps you updated with SOLIDWORKS news.

Sections in the Alerts tab include:

**Critical.** The Critical section includes important messages that used to appear in a dialog box. If a critical alert exists, the Welcome dialog box opens to the Critical section automatically on startup, even if you selected Do not show at startup in the dialog box. Alerts are displayed until you select Do not show this message again.



The Critical section does not appear if there are no critical alerts to display.

**Troubleshooting.** The Troubleshooting section includes troubleshooting messages and recovered documents that used to be on the SOLIDWORKS Recovery tab in the Task Pane.



If the software has a technical problem and an associated troubleshooting message exists, the Welcome dialog box opens to the Troubleshooting section automatically on startup, even if you selected Do not show at startup in the dialog box.

**Technical Alerts.** The Technical Alerts section opens the contents of the SOLIDWORKS Support Bulletins RSS feed at [solidworks.com](http://solidworks.com).

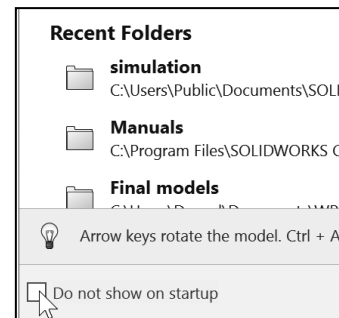
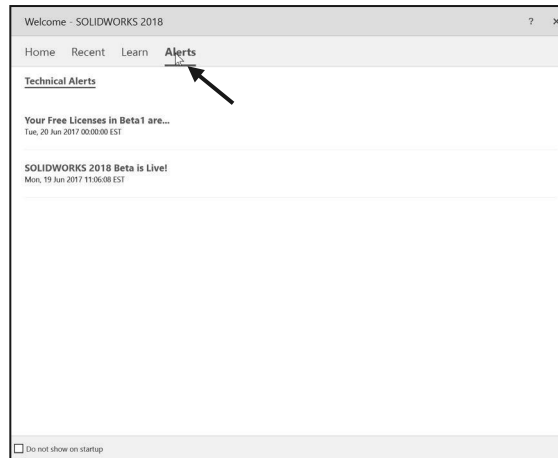



Close the Welcome dialog box.

- 5) Click **Close**  from the Welcome dialog box. The SOLIDWORKS Graphics window is displayed.

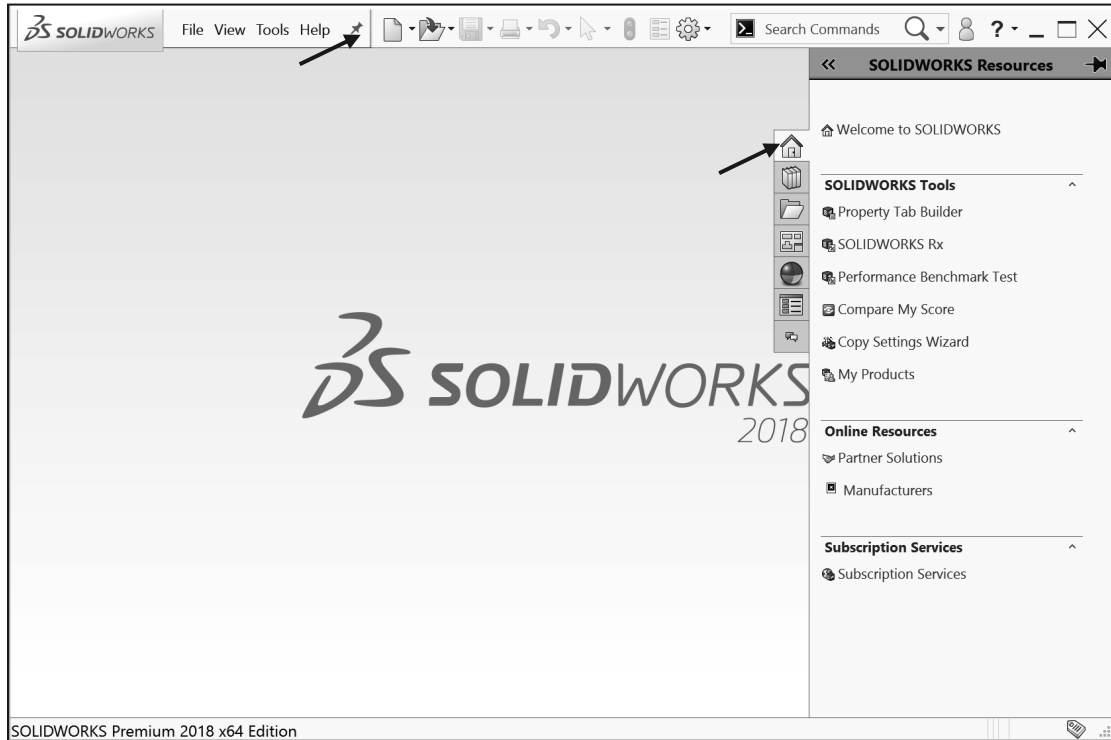

If you do not see this screen, click the SOLIDWORKS Resources  icon on the right side of the Graphics window located in the Task Pane.

- 6) **Hover** the mouse pointer over the SOLIDWORKS icon.



- 7) If needed, **Pin** the Menu Bar toolbar. View your options from the Menu bar menu: **File**, **View Tools** and **Help**.

## Menu Bar toolbar

The SOLIDWORKS (UI) is designed to make maximum use of the Graphics window. The Menu Bar toolbar contains a set of the most frequently used tool buttons from the Standard toolbar.

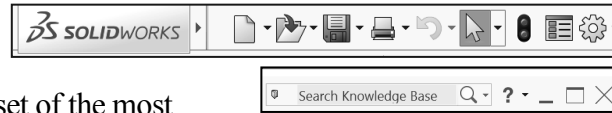

The following default tools are available:

- **New** - Creates a new document; **Open** - Opens an existing document; **Save** - Saves an active document; **Print** - Prints an active document; **Undo** - Reverses the last action; **Select** - Selects Sketch entities, components and more; **Rebuild** - Rebuilds the active part, assembly or drawing; **File Properties** - Shows the summary information on the active document; and **Options** - Changes system options and Add-Ins for SOLIDWORKS.

## Menu Bar menu

Click SOLIDWORKS in the Menu Bar toolbar to display the Menu Bar menu. SOLIDWORKS provides a context-sensitive menu structure. The menu titles remain the same for all three types of documents, but the menu items change depending on which type of document is active.



Example: The Insert menu includes features in part documents, mates in assembly documents, and drawing views in drawing documents. The display of the menu is also dependent on the workflow customization that you have selected. The default menu items for an active document are *File, Edit, View, Insert, Tools, Window, Help* and *Pin*.

The Pin option displays the Menu bar toolbar and the Menu bar menu as illustrated. Throughout the book, the Menu bar menu and the Menu bar toolbar are referred to as the Menu bar.

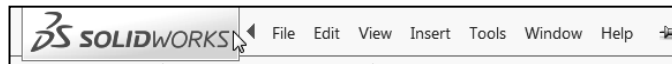

## Drop-down menu

SOLIDWORKS takes advantage of the familiar Microsoft® Windows user interface. Communicate with SOLIDWORKS through drop-down menus, Context sensitive toolbars, Consolidated toolbars or the CommandManager tabs.

 A command is an instruction that informs SOLIDWORKS to perform a task.

To close a SOLIDWORKS drop-down menu, press the Esc key. You can also click any other part of the SOLIDWORKS Graphics window or click another drop-down menu.

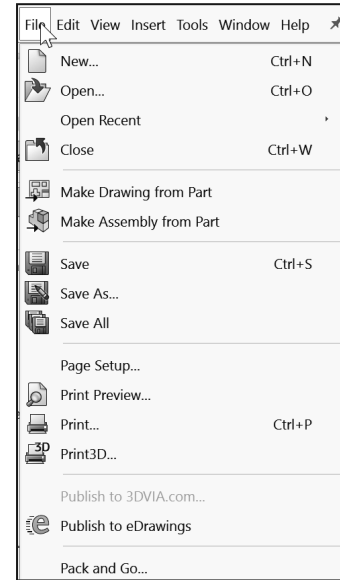

## Create a New Part Document

In the next section create a new part document.

### Activity: Create a new Part Document.

A part is a 3D model, which consists of features. What are features?

- Features are geometry building blocks.
- Most features either add or remove material.
- Some features do not affect material (Cosmetic Thread).
- Features are created either from 2D or 3D sketched profiles or from edges and faces of existing geometry.
- Features are individual shapes that combined with other features make up a part or assembly. Some features, such as bosses and cuts, originate as sketches. Other features, such as shells and fillets, modify a feature's geometry.
- Features are displayed in the FeatureManager as illustrated (Boss-Extrude1, Cut-Extrude1, Cut-Extrude2, Mirror1, Cut-Extrude3, and CirPattern1).

 The first sketch of a part is called the Base Sketch. The Base sketch is the foundation for the 3D model. In this book, we focus on 2D sketches and 3D features.

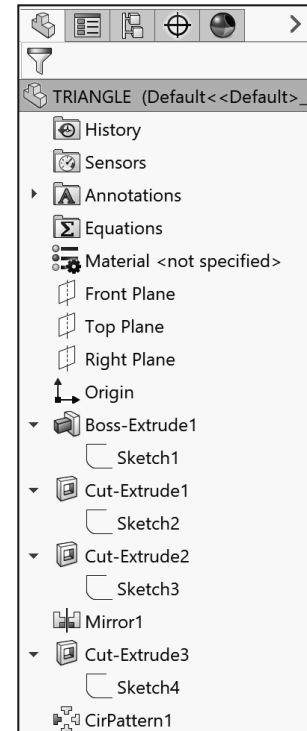

There are two modes in the New SOLIDWORKS Document dialog box: *Novice* and *Advanced*. The *Novice* option is the default option with three templates. The *Advanced* mode contains access to additional templates and tabs that you create in system options. Use the *Advanced* mode in this book.

Create a new part.

- 8) Click **New**  from the Menu bar. The New SOLIDWORKS Document dialog box is displayed.

Select the Advanced mode.

- 9) Click the **Advanced** button as illustrated. The Advanced mode is set.
- 10) Click the **Templates** tab.
- 11) Click **Part**. Part is the default template from the New SOLIDWORKS Document dialog box.
- 12) Click **OK** from the New SOLIDWORKS Document dialog box.

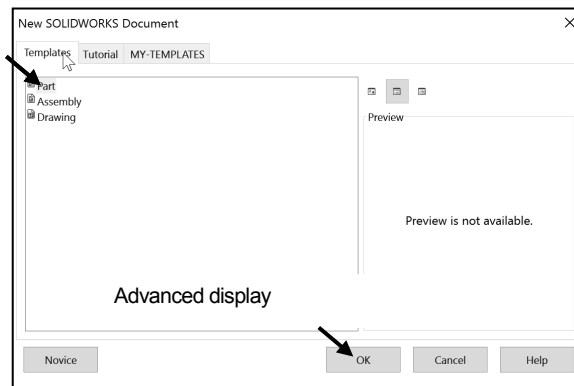
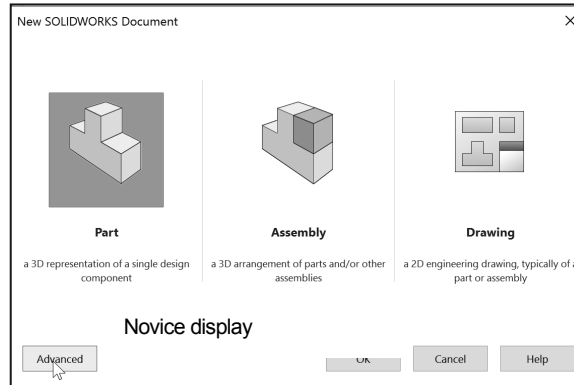

Illustrations may vary depending on your SOLIDWORKS version and operating system.

The Advanced mode remains selected for all new documents in the current SOLIDWORKS session. When you exit SOLIDWORKS, the Advanced mode setting is saved.

The default SOLIDWORKS installation contains two tabs in the New SOLIDWORKS Document dialog box: *Templates* and *Tutorial*. The *Templates* tab corresponds to the default SOLIDWORKS templates. The *Tutorial* tab corresponds to the templates utilized in the SOLIDWORKS Tutorials.

Part1 is displayed in the FeatureManager and is the name of the document. Part1 is the default part window name.

The Part Origin  is displayed in blue in the center of the Graphics window. The Origin represents the intersection of the three default reference planes: *Front Plane*, *Top Plane* and *Right Plane*. The positive X-axis is horizontal and points to the right of the Origin in the Front view. The positive Y-axis is vertical and points upward in the Front view. The FeatureManager contains a list of features, reference geometry, and settings utilized in the part.

 Edit the document units directly from the Graphics window as illustrated.

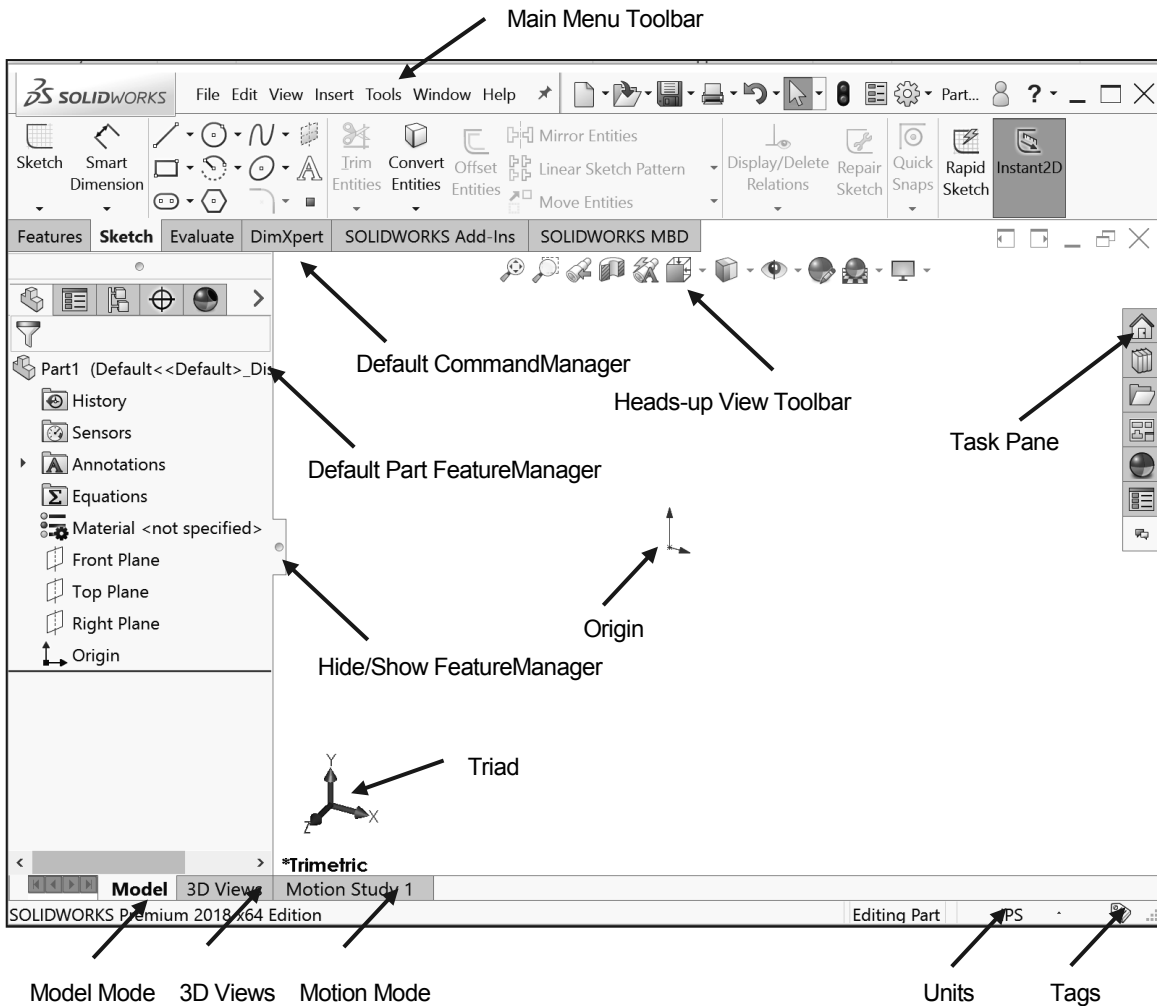
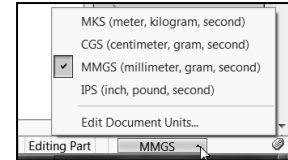

View the Default Sketch Planes.

- 13) Click the **Front Plane** from the FeatureManager.
- 14) Click the **Top Plane** from the FeatureManager.
- 15) Click the **Right Plane** from the FeatureManager.
- 16) Click the **Origin** from the FeatureManager. The Origin is the intersection of the Front, Top and Right Planes.

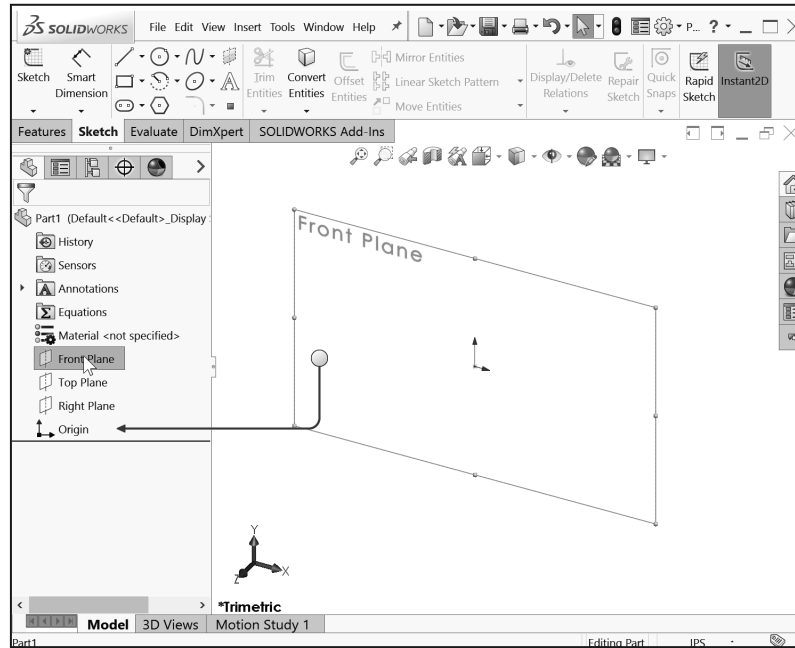

Redeem the code on the inside cover of the book. In the next section, download the SOLIDWORKS 2018 folder to your hard drive. Open the Bracket part. Review the features and sketches in the Bracket FeatureManager. Work directly from your hard drive.

**Activity: Download the SOLIDWORKS 2018 folder. Open a Part.**

Download the SOLIDWORKS 2018 folder. Open an existing SOLIDWORKS part.

- 17) **Download** the SOLIDWORKS 2018 folder to a local hard drive.
- 18) Click **Open**  from the Menu bar menu.
- 19) Browse to the **SOLIDWORKS 2018\Bracket** folder.
- 20) Double-click the **Bracket** part. The Bracket part is displayed in the Graphics window.

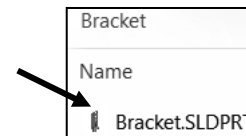
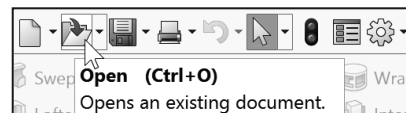

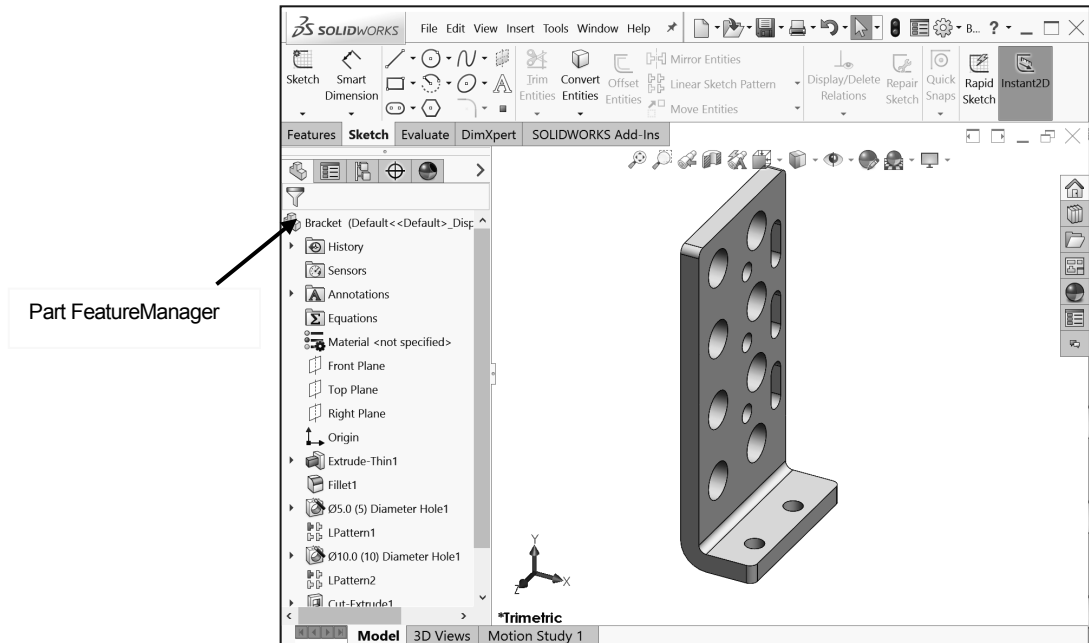

The FeatureManager design tree is located on the left side of the SOLIDWORKS Graphics window. The FeatureManager provides a summarized view of the active part, assembly, or drawing document. The tree displays the details on how the part, assembly or drawing document was created.

Use the FeatureManager rollback bar to temporarily roll back to an earlier state, to absorbed features, roll forward, roll to previous, or roll to the end of the FeatureManager design tree. You can add new features or edit existing features while the model is in the rolled-back state. You can save models with the rollback bar placed anywhere.

In the next section, review the features in the Bracket FeatureManager using the Rollback bar.

**Activity: Use the FeatureManager Rollback Bar option.**

Apply the FeatureManager Rollback Bar. Revert to an earlier state in the model.

- 21)** Place the **mouse pointer** over the rollback bar in the FeatureManager design tree as illustrated. The pointer changes to a hand . Note the provided information on the feature. This is called Dynamic Reference Visualization.
- 22)** Drag the **rollback bar** up the FeatureManager design tree until it is above the features you want rolled back, in this case 10.0 (10) Diameter Hole1.
- 23)** **Release** the mouse button.

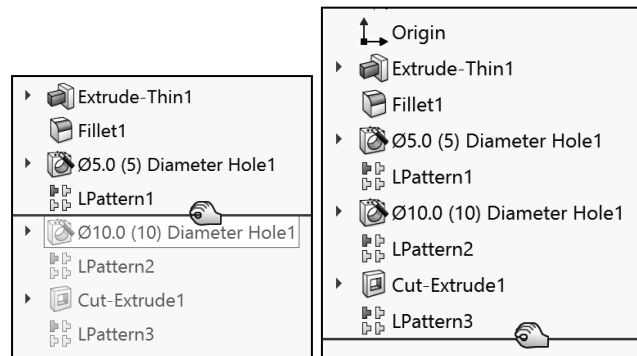

View the first feature in the Bracket Part.

- 24)** Drag the **rollback bar** up the FeatureManager above Fillet1. View the results in the Graphics window.

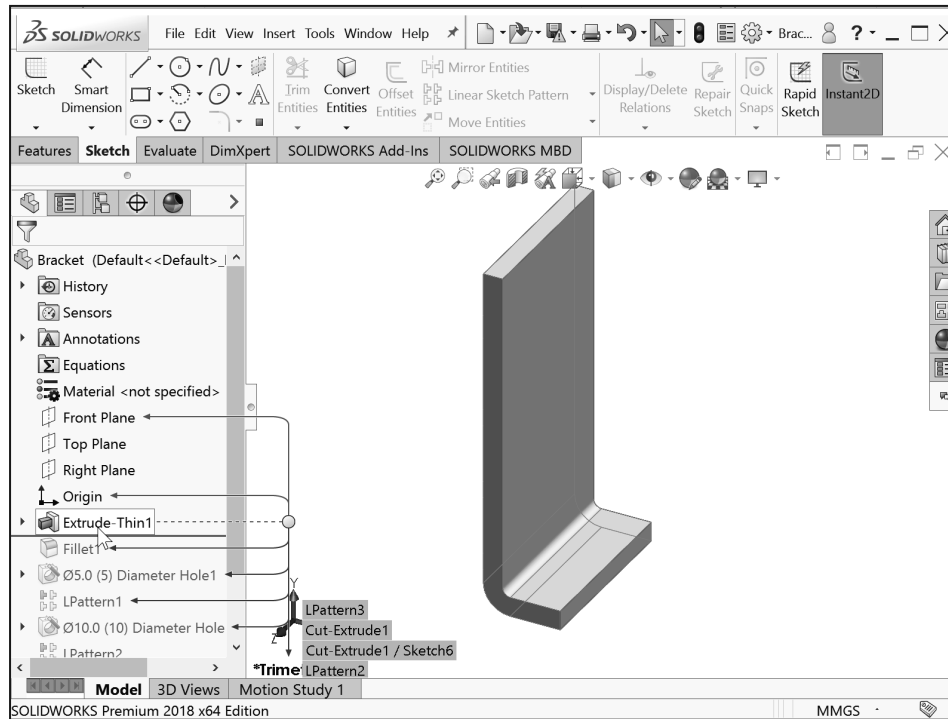

Return to the original Bracket Part FeatureManager.

- 25)** Right-click **Extrude-Thin1** in the FeatureManager. The Pop-up Context toolbar is displayed.
- 26)** Click **Roll to End**. View the results in the Graphics window.

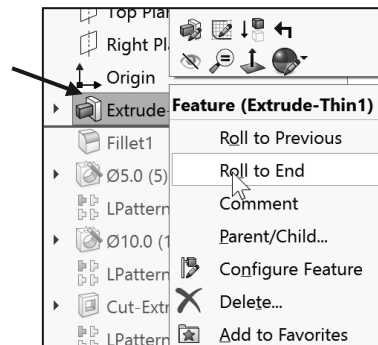
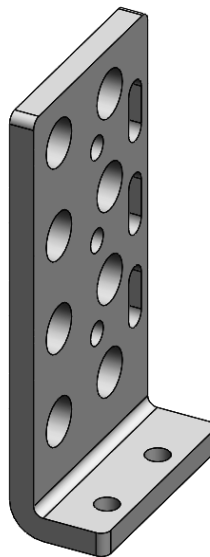





## Heads-up View toolbar

SOLIDWORKS provides the user with numerous view options. One of the most useful tools is the Heads-up View toolbar displayed in the Graphics window when a document is active.



 *Dynamic Annotation Views* : Only available with SOLIDWORKS MBD (Model Based Definition). Provides the ability to control how annotations are displayed when you rotate models.

In the next section, apply the following tools: Zoom to Fit, Zoom to Area, Zoom out, Rotate and select various view orientations from the Heads-up View toolbar.

**Activity: Utilize the Heads-up View toolbar.**

Zoom to Fit the model in the Graphics window.

**27)** Click the **Zoom to Fit**  icon. The tool fits the model to the Graphics window.

Zoom to Area on the model in the Graphics window.

**28)** Click the **Zoom to Area**  icon. The Zoom to Area  icon is displayed.

Zoom in on the top left hole.

**29)** **Window-select** the top left corner as illustrated. View the results.

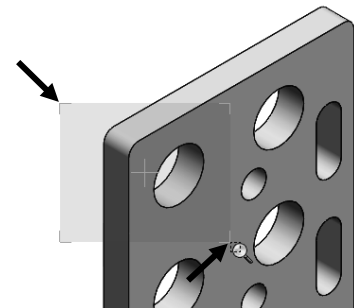

De-select the Zoom to Area tool.



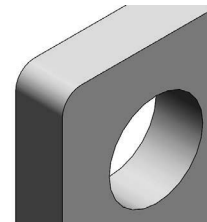

**30)** Click the **Zoom to Area**  icon.

Fit the model to the Graphics window.

**31)** Press the **f** key.



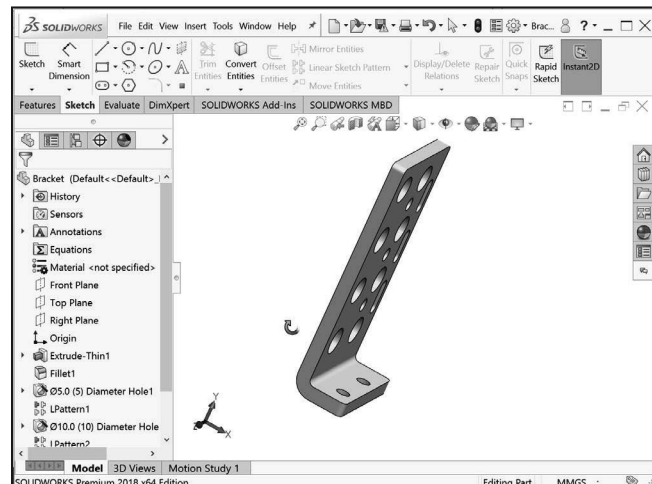

Rotate the model.

**32)** Hold the **middle mouse button** down. Drag **upward** , **downward** , to the **left**  and to the **right**  to rotate the model in the Graphics window.



Display a few Standard Views.

- 33) Click **inside** the Graphics window.
- 34) Click **Front**  from the drop-down Heads-up view toolbar. The model is displayed in the Front view.
- 35) Click **Right**  from the drop-down Heads-up view toolbar. The model is displayed in the Right view.
- 36) Click **Top**  from the drop-down Heads-up view toolbar. The model is displayed in the Top view.

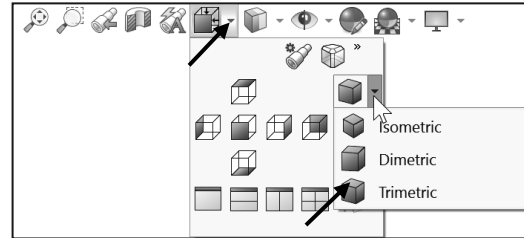
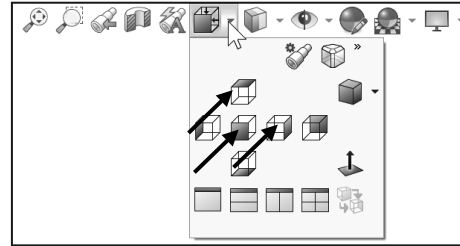

Display a Trimetric view of the Bracket model.

- 37) Click **Trimetric**  from the drop-down Heads-up view toolbar as illustrated. Note your options. View the results in the Graphics window.

### SOLIDWORKS Help

Help in SOLIDWORKS is context-sensitive and in HTML format. Help is accessed in many ways, including Help buttons in all dialog boxes and PropertyManager (or press F1) and Help (?) tool on the Standard toolbar for SOLIDWORKS Help.

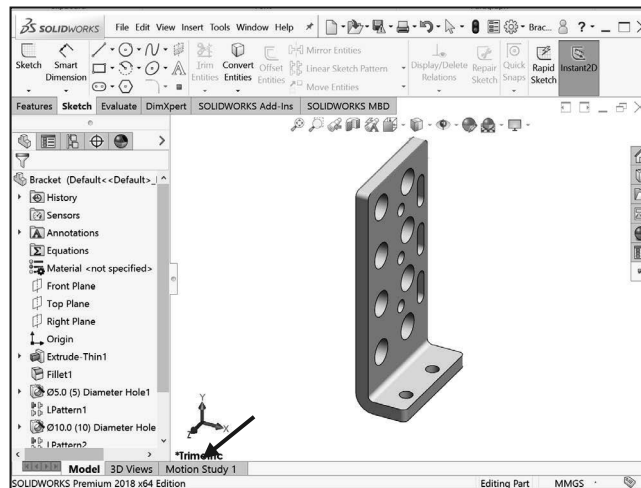

- 38) Click **Help** from the Menu bar.
- 39) Click **SOLIDWORKS Help**. The SolidWorks Help Home Page is displayed by default. View your options.

 **SOLIDWORKS Web Help** is active by default under Help in the Main menu.

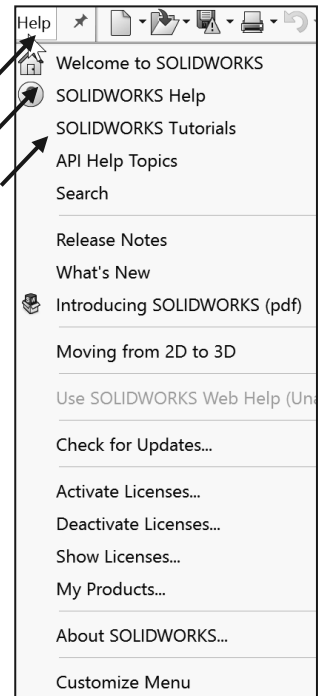

Close Help. Return to the SOLIDWORKS Graphics window.

- 40) **Close**  SOLIDWORKS Home.

### SOLIDWORKS Tutorials

Display and explore the SOLIDWORKS tutorials.

- 41) Click **Help** from the Menu bar.
- 42) Click **SOLIDWORKS Tutorials**. The SOLIDWORKS Tutorials are displayed. The SOLIDWORKS Tutorials are presented by category.
- 43) Click the **Getting Started** category. The Getting Started category provides lessons on parts, assemblies, and drawings.

In the next section, close all models, tutorials and view the additional User Interface tools.

**Activity: Close all Tutorials and Models.**

Close SOLIDWORKS Tutorials and models.

- 44) **Close**  SOLIDWORKS Tutorials.
- 45) Click **Window, Close All** from the Menu bar menu.

### SOLIDWORKS Icon Style

SOLIDWORKS provides a new icon style. It also allows vector-based scaling for superior support of high resolution high pixel density displays. The icon style standardized the perspective of icons. It removes non-essential details, and emphasizes primary elements. Consistent visual styling applies to all icons.

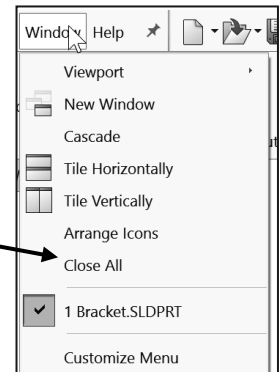

### Additional User Interface Tools

The book utilizes additional areas of the SOLIDWORKS User Interface. Explore an overview of these tools in the next section.

### Right-click

Right-click in the Graphics window on a model, or in the FeatureManager on a feature or sketch to display the Context-sensitive toolbar. If you are in the middle of a command, this toolbar displays a list of options specifically related to that command.

Right-click an empty space in the Graphics window of a part or assembly, and a selection context toolbar above the shortcut menu is displayed. This provides easy access to the most commonly used selection tools.

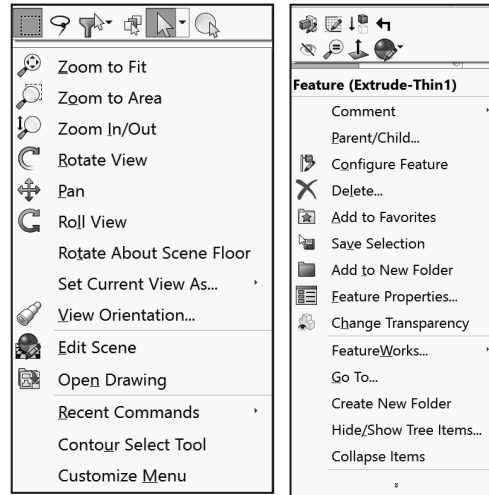

### Consolidated toolbar

Similar commands are grouped together in the CommandManager. For example, variations of the Rectangle sketch tool are grouped in a single fly-out button as illustrated.

If you select the Consolidated toolbar button without expanding:

For some commands such as Sketch, the most commonly used command is performed. This command is the first listed and the command shown on the button.

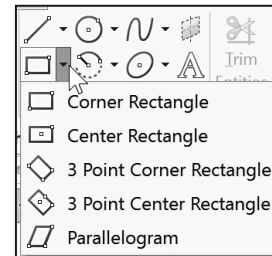

For commands such as rectangle, where you may want to repeatedly create the same variant of the rectangle, the last used command is performed. This is the highlighted command when the Consolidated toolbar is expanded.

### System feedback icon

SOLIDWORKS provides system feedback by attaching a symbol to the mouse pointer cursor.

The system feedback symbol indicates what you are selecting or what the system is expecting you to select.

As you move the mouse pointer across your model, system feedback is displayed in the form of a symbol, riding next to the cursor as illustrated. This is a valuable feature in SOLIDWORKS.

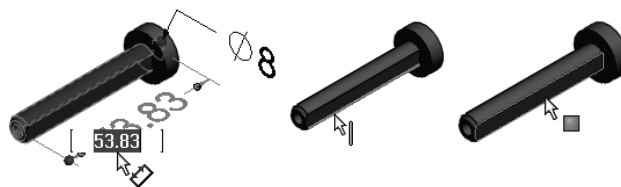
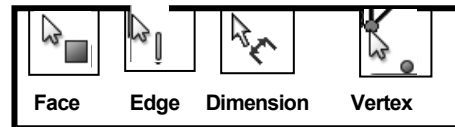

## Confirmation Corner

When numerous SOLIDWORKS commands are active, a symbol or a set of symbols is displayed in the upper right hand corner of the Graphics window. This area is called the Confirmation Corner.

When a sketch is active, the confirmation corner box displays two symbols. The first symbol is the sketch tool icon. The second symbol is a large red X. These two symbols supply a visual reminder that you are in an active sketch. Click the sketch symbol icon to exit the sketch and to save any changes that you made.

When other commands are active, the confirmation corner box provides a green check mark and a large red X. Use the green check mark to execute the current command. Use the large red X to cancel the command.



Confirm changes you make in sketches and tools by using the D keyboard shortcut to move the OK and Cancel buttons to the pointer location in the Graphics window.

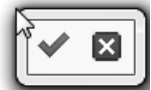
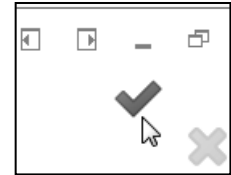
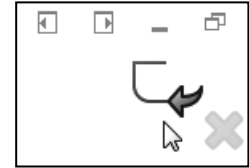

## Heads-up View toolbar

SOLIDWORKS provides the user with numerous view options from the Standard Views, View and Heads-up View toolbar.



The Heads-up View toolbar is a transparent toolbar that is displayed in the Graphics window when a document is active.

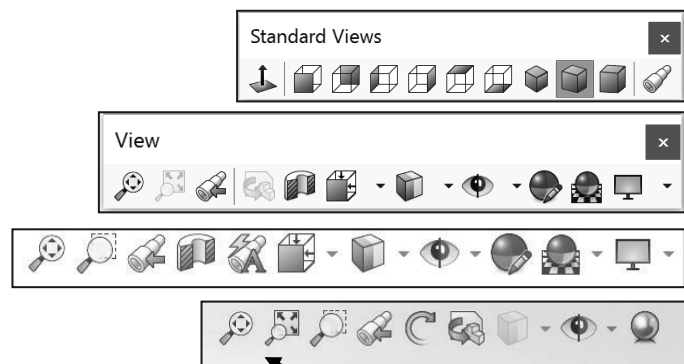

You can hide, move or modify the Heads-up View toolbar. To modify the Heads-up View toolbar, right-click on a tool and select or deselect the tools that you want to display.



For a drawing document

The following views are available. Note: available views are document dependent.

- *Zoom to Fit* : Zooms the model to fit the Graphics window.
- *Zoom to Area* : Zooms to the areas you select with a bounding box.
- *Previous View* : Displays the previous view.

- *Section View* : Displays a cutaway of a part or assembly, using one or more cross section planes.
- *Dynamic Annotation Views* : Only available with SOLIDWORKS MBD. Provides the ability to control how annotations are displayed when you rotate models.

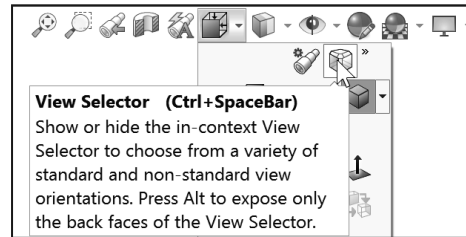

The Orientation dialog has an option to display a view cube (in-context View Selector) with a live model preview. This helps the user to understand how each standard view orientates the model. With the view cube, you can access additional standard views. The views are easy to understand and they can be accessed simply by selecting a face on the cube.

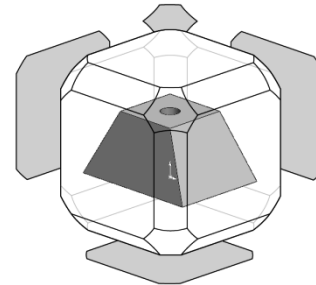

To activate the Orientation dialog box, press (Ctrl + spacebar) or click the View Orientation  icon from the Heads up View toolbar. The active model is displayed in the View Selector in an Isometric orientation (default view).





Click the View Selector icon in the Orientation dialog box to show or hide the in-context View Selector.



Press **Ctrl + spacebar** to activate the View Selector.



Press the **spacebar** to activate the Orientation dialog box.

- *View Orientation box* : Provides the ability to select a view orientation or the number of viewports. The available options are *Top, Left, Front, Right, Back, Bottom, Single view, Two view - Horizontal, Two view - Vertical, Four view*. Click the drop-down arrow to access Axonometric views: *Isometric, Dimetric and Trimetric*.
- *Display Style* : Provides the ability to display the style for the active view. The available options are *Wireframe, Hidden Lines Visible, Hidden Lines Removed, Shaded, Shaded With Edges*.

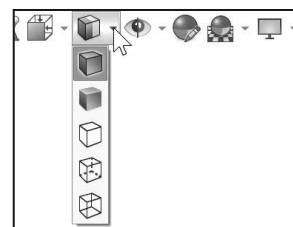
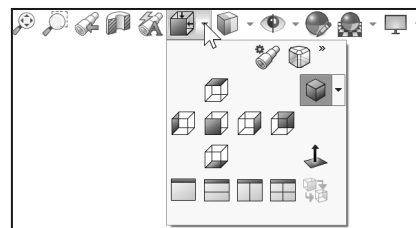

- *Hide/Show Items* : Provides the ability to select items to hide or show in the Graphics window. The available items are document dependent. Note the View Center of Mass icon.
- *Edit Appearance* : Provides the ability to edit the appearance of entities of the model.
- *Apply Scene* : Provides the ability to apply a scene to an active part or assembly document. View the available options.
- *View Setting* : Provides the ability to select the following settings: *RealView Graphics*, *Shadows In Shaded Mode*, *Ambient Occlusion*, *Perspective* and *Cartoon*.
- *Rotate view* : Provides the ability to rotate a drawing view. Input Drawing view angle and select the ability to update and rotate center marks with view.
- *3D Drawing View* : Provides the ability to dynamically manipulate the drawing view in 3D to make a selection.

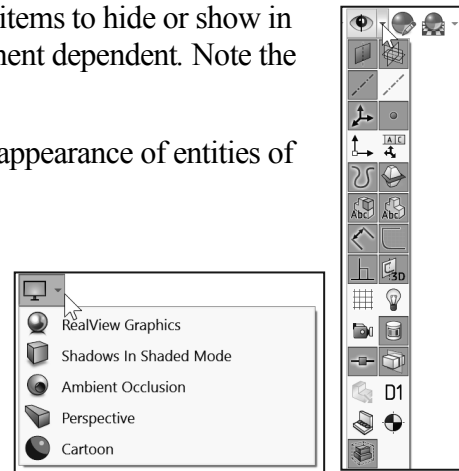

To display a grid for a part, click Options , Document Properties tab. Click Grid/Snaps; check the Display grid box.

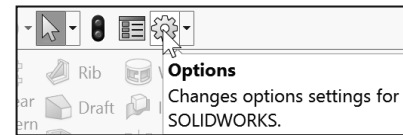

Add a custom view to the Heads-up View toolbar. Press the space key. The Orientation dialog box is displayed. Click the New View tool. The Name View dialog box is displayed. Enter a new named view. Click OK.

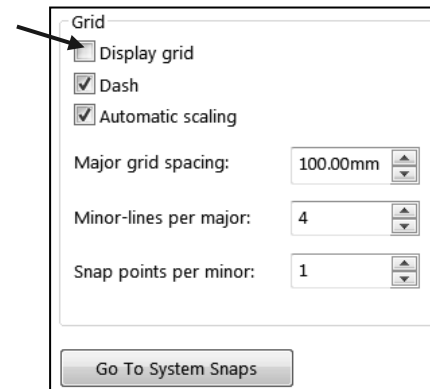

Use commands to display information about the triad or to change the position and orientation of the triad. Available commands depend on the triad's context.

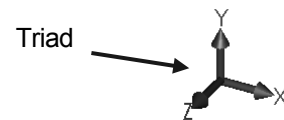

## SOLIDWORKS CommandManager

The SOLIDWORKS CommandManager is a Context-sensitive toolbar that automatically updates based on the toolbar you want to access. By default, it has toolbars embedded in it based on your active document type. When you click a tab below the CommandManager, it updates to display that toolbar. For example, if you click the Sketch tab, the Sketch toolbar is displayed.

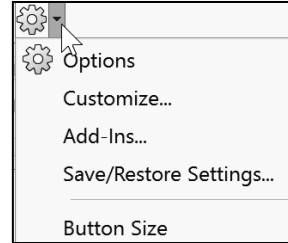

For commercial users, SOLIDWORKS Model Based Definition (MBD) is a separate application. For education users, SOLIDWORKS MBD is included in the SOLIDWORKS Education Edition as an Add In.

Below is an illustrated CommandManager for a default Part document.

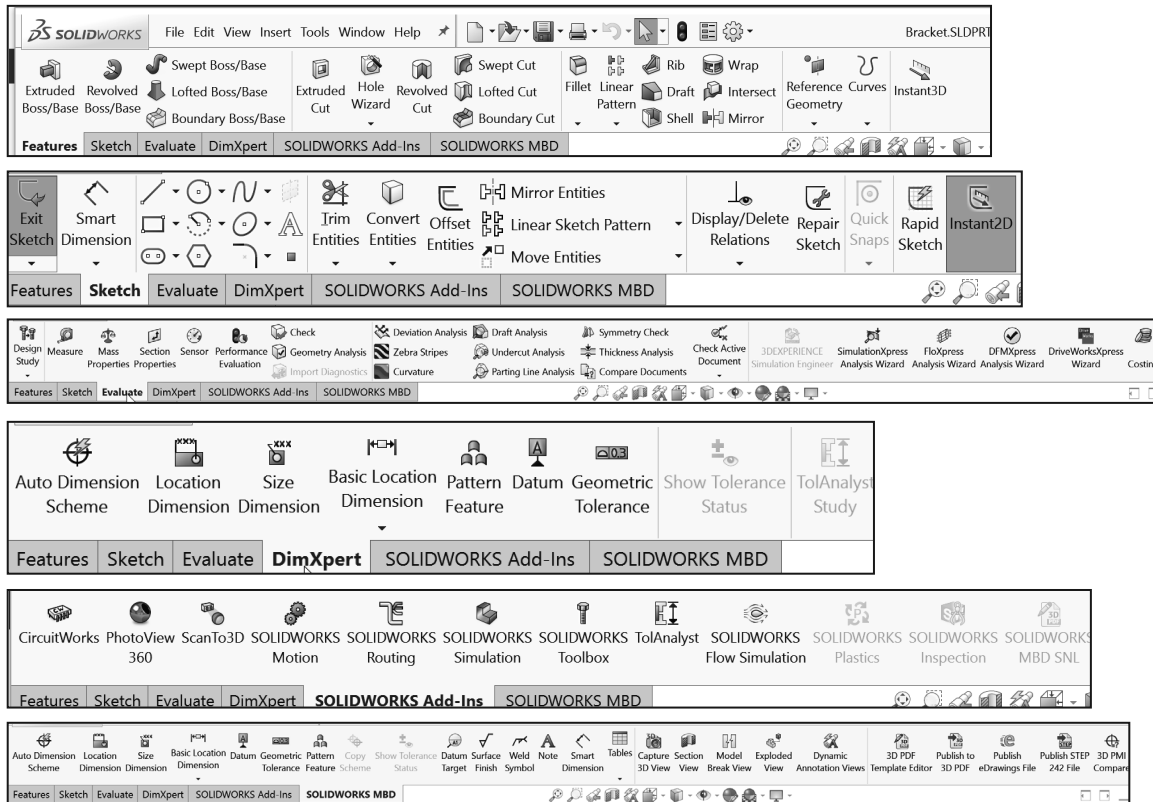

Button sizes. You can set sizes for buttons from the Toolbars tab of the Customize dialog box. To facilitate element selection on touch interfaces such as tablets, you can set up the larger Size buttons and text from the Options menu (Standard toolbar).

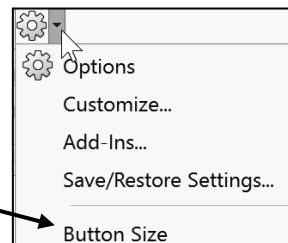



The SOLIDWORKS CommandManager is a Context-sensitive toolbar that automatically updates based on the toolbar you want to access. By default, it has toolbars embedded in it based on your active document type.

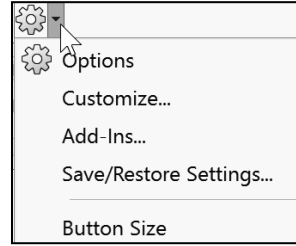

For commercial users, SOLIDWORKS Model Based Definition (MBD) is a separate application. For education users, SOLIDWORKS MBD is included in the SOLIDWORKS Education Edition as an Add In.

Below is an illustrated CommandManager for a default Drawing document.

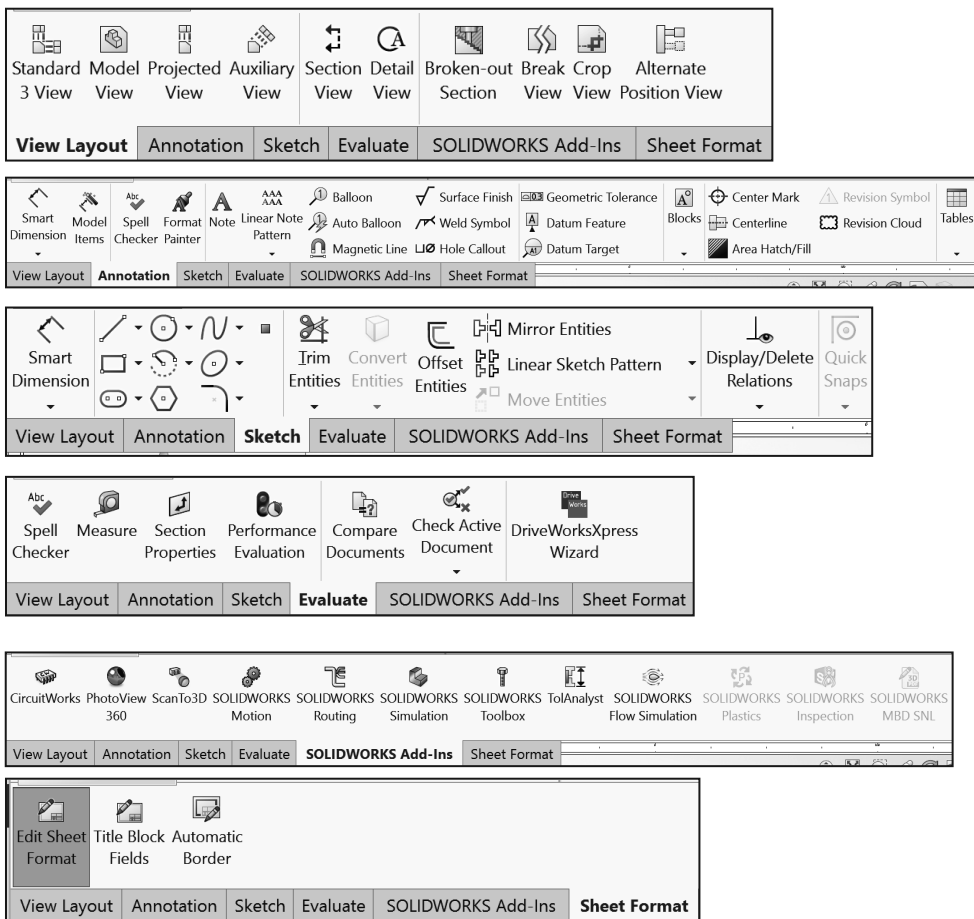

To add a custom tab to your CommandManager, right-click on a tab and click Customize CommandManager from the drop-down menu. The Customize dialog box is displayed. You can also select to add a blank tab as illustrated and populate it with custom tools from the Customize dialog box.

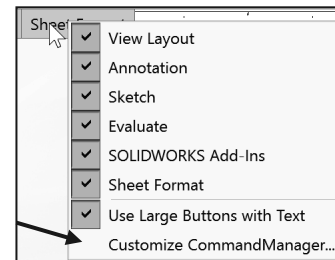

The SOLIDWORKS CommandManager is a Context-sensitive toolbar that automatically updates based on the toolbar you want to access. By default, it has toolbars embedded in it based on your active document type.

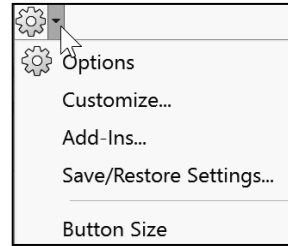

For commercial users, SOLIDWORKS Model Based Definition (MBD) is a separate application. For education users, SOLIDWORKS MBD is included in the SOLIDWORKS Education Edition as an Add In.

Below is an illustrated CommandManager for a default Assembly document.

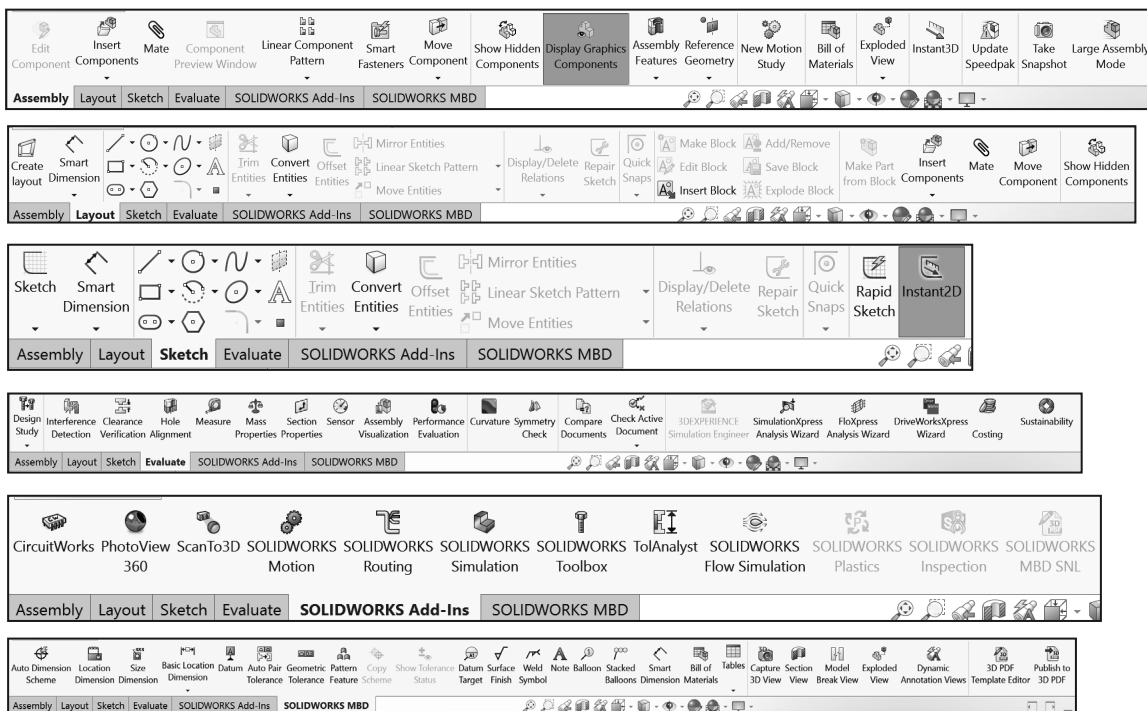

By default, the illustrated options are selected in the Customize box for the CommandManager. Right-click on an existing tab and click Customize CommandManager to view your options.



You can set the number of mouse gestures to 2, 3, 4, 6, 8, or 12 gestures. If you set the number to 2 gestures, you can orient them vertically or horizontally.

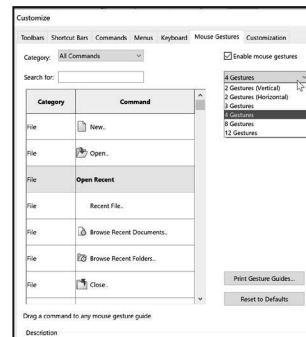

Float the CommandManager. Drag the Features, Sketch or any CommandManager tab. Drag the CommandManager anywhere on or outside the SOLIDWORKS window.

To dock the CommandManager, perform one of the following:

While dragging the CommandManager in the SOLIDWORKS window, move the pointer over a docking icon -









Double-click the floating CommandManager to revert the CommandManager to the last docking position.

Screen shots in the book were made using SOLIDWORKS 2018 SP0 running Windows® 10.

 An updated color scheme for certain icons makes the SOLIDWORKS application more accessible to people with color blindness. Icons in the active PropertyManager use blue to indicate what you must select on the screen: faces, edges, and so on.

### Selection Enhancements

Right-click an empty space in the Graphics window of a part or assembly; a selection context toolbar above the shortcut menu provides easy access to the most commonly used selection tools.

- **Box Selection** . Provides the ability to select entities in parts, assemblies, and drawings by dragging a selection box with the pointer.
- **Lasso Selection** . Provides the ability to select entities by drawing a lasso around the entities.
- **Selection Filters** . Displays a list of selection filter commands.
- **Previous Selection** . Displays the previous selection.
- **Select Other** . Displays the Select Other dialog box.
- **Select** . Displays a list of selection commands.
- **Magnified Selection** . Displays the magnifying glass, which gives you a magnified view of a section of a model.

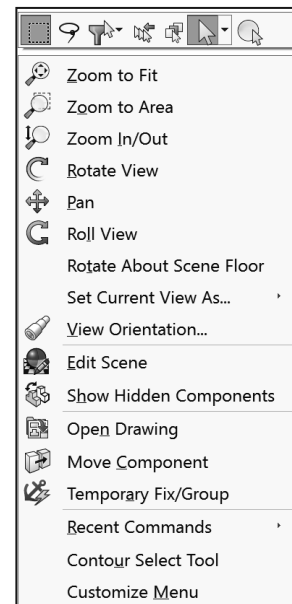
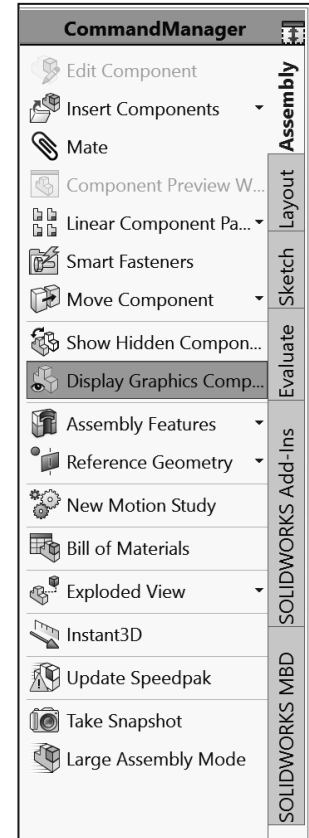



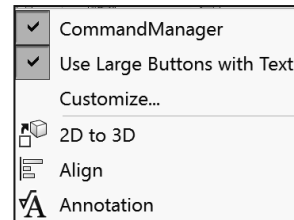

 Save space in the CommandManager, right-click in the CommandManager and un-check the Use Large Buttons with Text box. This eliminates the text associated with the tool.



 DimXpert provides the ability to graphically check if the model is fully dimensioned and toleranced. DimXpert automatically recognizes manufacturing features. Manufacturing features are not SOLIDWORKS features. Manufacturing features are defined in 1.1.12 of the ASME Y14.5M-1994 Dimensioning and Tolerancing standard. See SOLIDWORKS Help for additional information.



### FeatureManager Design Tree

The FeatureManager consists of five default tabs:

- *FeatureManager design tree*  tab.
- *PropertyManager*  tab.
- *ConfigurationManager*  tab.
- *DimXpertManager*  tab.
- *DisplayManager*  tab.

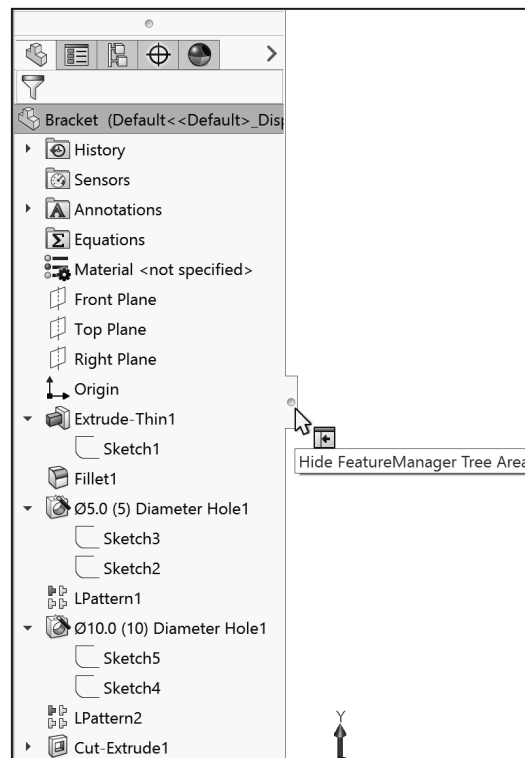
Select the Hide FeatureManager Tree Area arrows  as illustrated to enlarge the Graphics window for modeling.



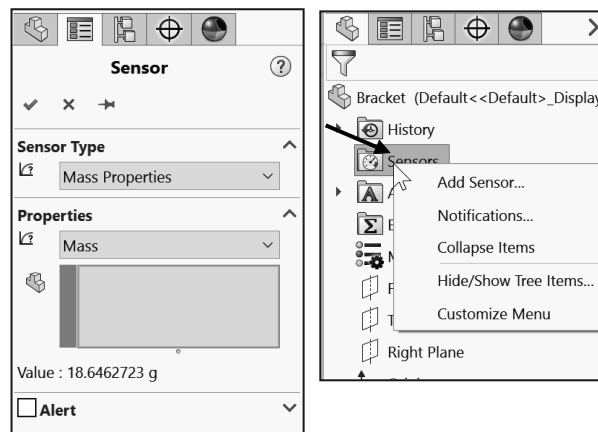

 The Sensors tool  located in the FeatureManager monitors selected properties in a part or assembly and alerts you when values deviate from the specified limits. There are five sensor types: Simulation Data, Mass properties, Dimensions, Measurement and Costing Data.





Various commands provide the ability to control what is displayed in the FeatureManager design tree. They are:

1. Show or Hide FeatureManager items.

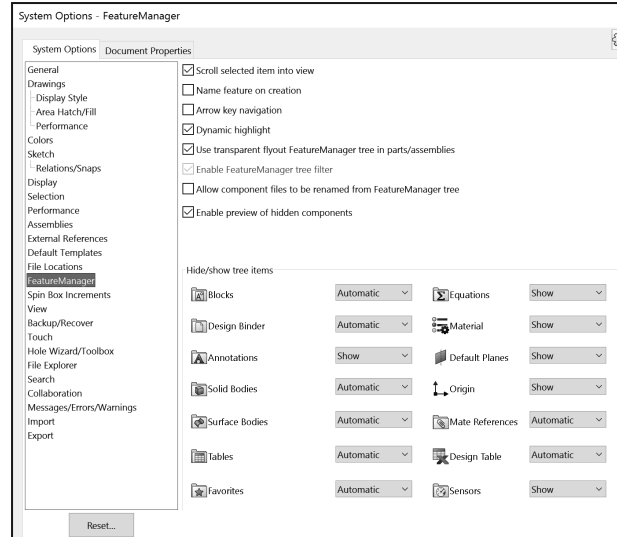
 Click **Options**  from the Menu bar. Click **FeatureManager** from the System Options tab. **Customize** your FeatureManager from the Hide/Show Tree Items dialog box.



2. Filter the FeatureManager design tree. Enter information in the filter field. You can filter by *Type of features, Feature names, Sketches, Folders, Mates, User-defined tags* and *Custom properties*.

 Tags are keywords you can add to a SOLIDWORKS document to make them easier to filter and to search. The Tags  icon is located in the bottom right corner of the Graphics window.

 Collapse all items in the FeatureManager, **right-click** and select **Collapse items**, or press the **Shift + C** keys.

The FeatureManager design tree and the Graphics window are dynamically linked. Select sketches, features, drawing views, and construction geometry in either pane.

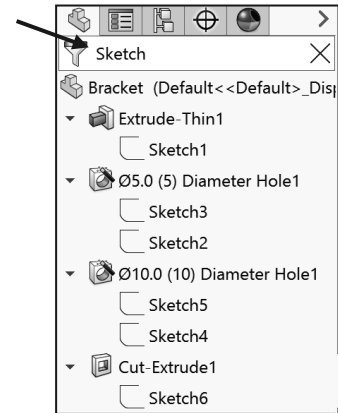

Split the FeatureManager design tree and either display two FeatureManager instances, or combine the FeatureManager design tree with the ConfigurationManager or PropertyManager.

Move between the FeatureManager design tree, PropertyManager, ConfigurationManager and DimXpertManager by selecting the tabs at the top of the menu.

Split line

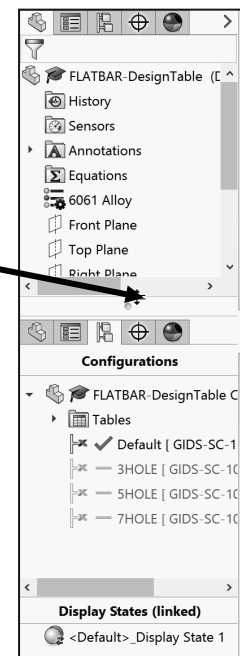



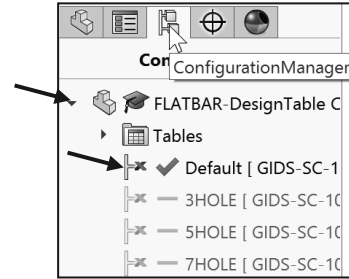



The ConfigurationManager is located to the right of the FeatureManager. Use the ConfigurationManager to create, select and view multiple configurations of parts and assemblies.



The icons in the ConfigurationManager denote whether the configuration was created manually or with a design table.

The DimXpertManager tab provides the ability to insert dimensions and tolerances manually or automatically. The DimXpertManager provides the following selections: **Auto**

**Dimension Scheme** , **Basic Location Dimension** , **Basic Size Dimension** , **Show Tolerance Status** , **Copy Scheme**  and **TolAnalyst Study** .

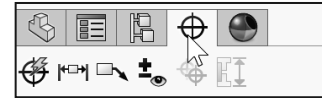

### Fly-out FeatureManager

The fly-out FeatureManager design tree provides the ability to view and select items in the PropertyManager and the FeatureManager design tree at the same time.

Throughout the book, you will select commands and command options from the drop-down menu, fly-out FeatureManager, Context toolbar or from a SOLIDWORKS toolbar.

 Another method for accessing a command is to use the accelerator key. Accelerator keys are special key strokes, which activate the drop-down menu options. Some commands in the menu bar and items in the drop-down menus have an underlined character.

Pressing the Alt or Ctrl key followed by the corresponding key to the underlined character activates that command or option.

 Illustrations may vary depending on your SOLIDWORKS version and operating system.

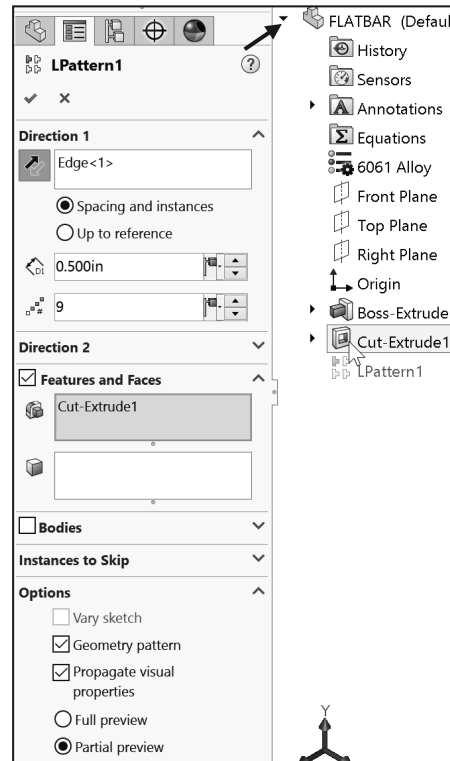

## Task Pane

The Task Pane is displayed when a SOLIDWORKS session starts. You can show, hide, and reorder tabs in the Task Pane. You can also set a tab as the default so it appears when you open the Task Pane, pin or unpin to the default location.

The Task Pane contains the following default tabs:

- *SOLIDWORKS Resources* .
- *Design Library* .
- *File Explorer* .
- *View Palette* .
- *Appearances, Scenes and Decals* .
- *Custom Properties* .
- *SOLIDWORKS Forum* .



Additional tabs are displayed with Add-Ins.

Use the **Back** and **Forward** buttons in the Design Library tab and the Appearances, Scenes, and Decals tab of the Task Pane to navigate in folders.

## SOLIDWORKS Resources

The basic SOLIDWORKS Resources  menu displays the following default selections:

- *Welcome to SOLIDWORKS.*
- *SOLIDWORKS Tools.*
- *Online Resources.*
- *Subscription Services.*

Other user interfaces are available during the initial software installation selection: *Machine Design, Mold Design, Consumer Products Design, etc.*

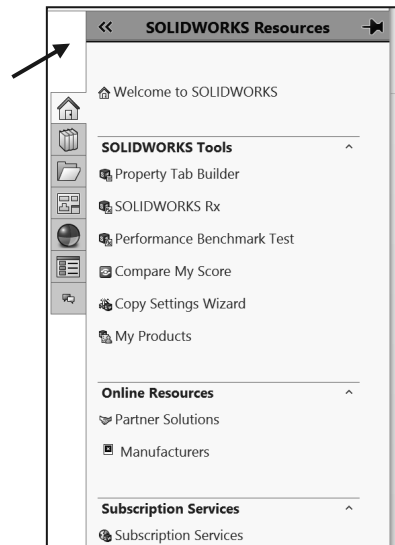
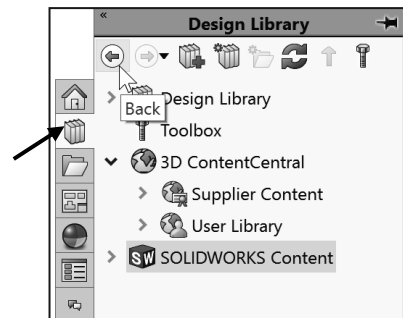

## Design Library

The Design Library  contains reusable parts, assemblies, and other elements including library features.

The Design Library tab contains four default selections. Each default selection contains additional sub categories.

The default selections are:

- *Design Library.*
- *Toolbox.*
- *3D ContentCentral (Internet access required).*
- *SOLIDWORKS Content (Internet access required).*



Activate the SOLIDWORKS Toolbox. Click Tools, Add-Ins., from the Main menu. Check the SOLIDWORKS Toolbox Library and SOLIDWORKS Toolbox Utilities box from the Add-ins dialog box or click SOLIDWORKS Toolbox from the SOLIDWORKS Add-Ins tab.

To access the Design Library folders in a non-network environment, click Add File Location  and browse to the needed path. Paths may vary depending on your SOLIDWORKS version and window setup. In a network environment, contact your IT department for system details.

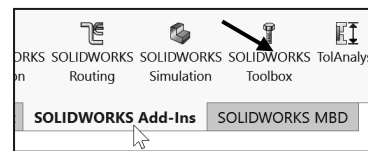
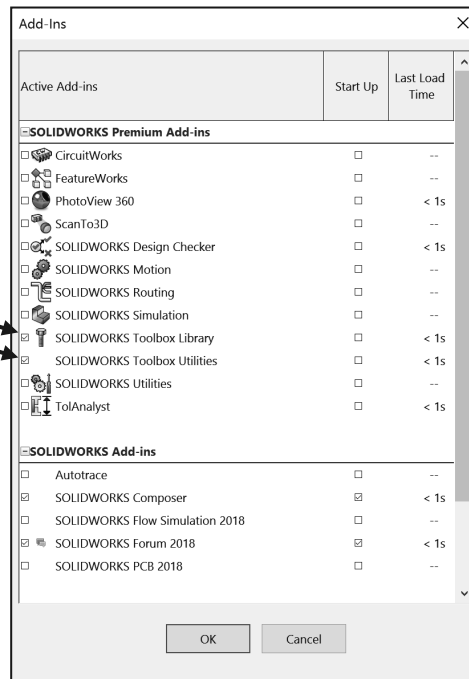
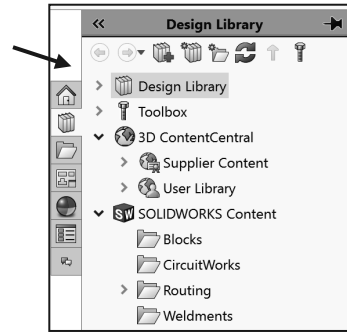

## File Explorer

File Explorer  duplicates Windows Explorer from your local computer and displays:

- *Recent Documents.*
- *Samples.*
- *Open in SOLIDWORKS*
- *Desktop.*

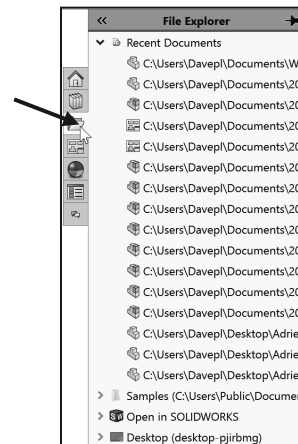





## Search

The SOLIDWORKS Search box is displayed in the upper right corner of the SOLIDWORKS Graphics window (Menu Bar toolbar). Enter the text or key words to search.

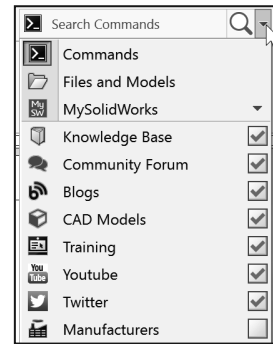
New search modes have been added to SOLIDWORKS Search as illustrated.



## View Palette

The View Palette  tool located in the Task Pane provides the ability to insert drawing views of an active document, or click the Browse button to locate the desired document.

Click and drag the view from the View Palette into an active drawing sheet to create a drawing view.

 The selected model is FLATBAR DesignTables in the illustration.

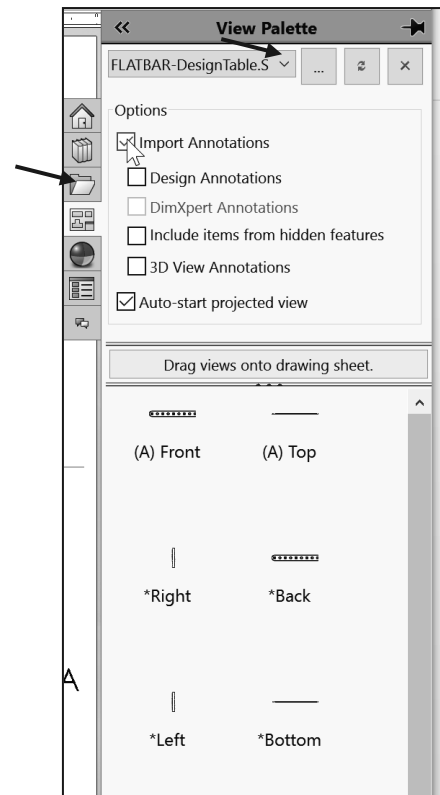

## Appearances, Scenes, and Decals

Appearances, Scenes and Decals  provide a simplified way to display models in a photo-realistic setting using a library of Appearances, Scenes, and Decals.

An appearance defines the visual properties of a model, including color and texture. Appearances do not affect physical properties, which are defined by materials.

Scenes provide a visual backdrop behind a model. In SOLIDWORKS they provide reflections on the model. PhotoView 360 is an Add-in. Drag and drop a selected appearance, scene or decal on a feature, surface, part or assembly.

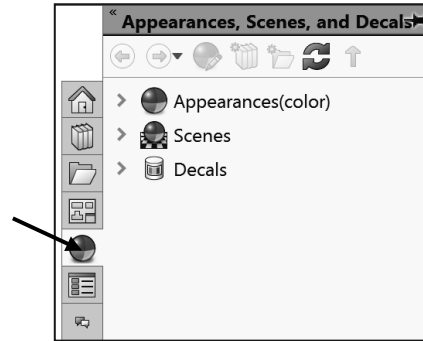

## Custom Properties

The Custom Properties  tool provides the ability to enter custom and configuration specific properties directly into SOLIDWORKS files.

## SOLIDWORKS Forum

Click the SOLIDWORKS Forum  icon to search directly within the Task Pane. An internet connection is required. You are required to register and to log in for postings and discussions.

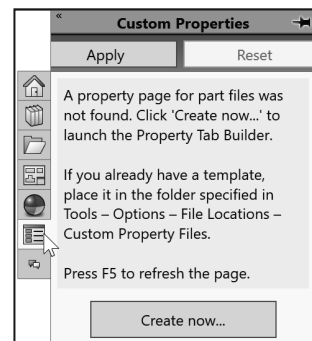

## User Interface for Scaling High Resolution Screens

The SOLIDWORKS software supports high-resolution, high-pixel density displays. All aspects of the user interface respond to the Microsoft Windows® display scaling setting. In dialog boxes, PropertyManagers, and the FeatureManager design tree, the SOLIDWORKS software uses your display scaling setting to display buttons and icons at an appropriate size. Icons that are associated with text are scaled to a size appropriate for the text. In addition, for toolbars, you can display Small, Medium, or Large buttons. Click the **Options drop-down arrow** from the Standard Menu bar, and click Button size to size the icons.

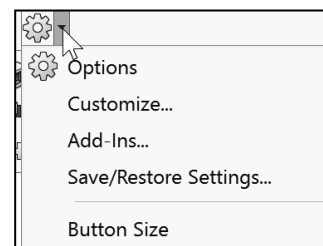

## Motion Study tab

Motion Studies are graphical simulations of motion for an assembly. Access the MotionManager from the Motion Study tab. The Motion Study tab is located in the bottom left corner of the Graphics window.

Incorporate visual properties such as lighting and camera perspective. Click the Motion Study tab to view the MotionManager. Click the Model tab to return to the FeatureManager design tree.

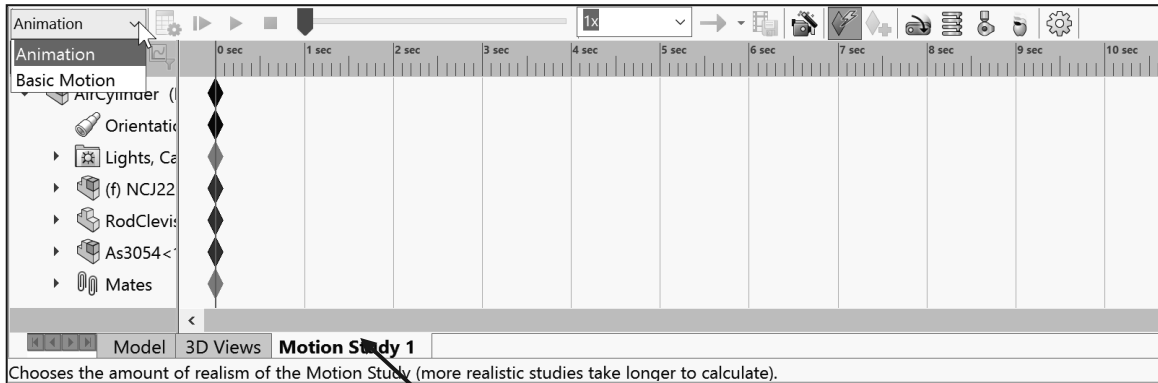

The MotionManager displays a timeline-based interface and provides the following selections from the drop-down menu as illustrated:

- *Animation:* Apply Animation to animate the motion of an assembly. Add a motor and insert positions of assembly components at various times using set key points. Use the Animation option to create animations for motion that do **not** require accounting for mass or gravity.
- *Basic Motion:* Apply Basic Motion for approximating the effects of motors, springs, collisions and gravity on assemblies. Basic Motion takes mass into account in calculating motion. Basic Motion computation is relatively fast, so you can use this for creating presentation animations using physics-based simulations. Use the Basic Motion option to create simulations of motion that account for mass, collisions or gravity.

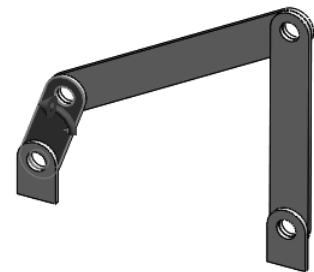

 If the Motion Study tab is not displayed in the Graphics window, click **View** > **Toolbars** > **MotionManager** from the Menu bar.

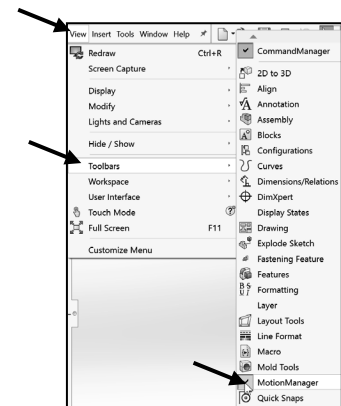

### 3D Views tab

SOLIDWORKS MBD (Model Based Definition) lets you create models without the need for drawings giving you an integrated manufacturing solution. MBD helps companies define, organize, and publish 3D product and manufacturing information (PMI), including 3D model data in industry standard file formats.

Create 3D drawing views of your parts and assemblies that contain the model settings needed for review and manufacturing. This lets users navigate back to those settings as they evaluate the design.

Use the tools in the SOLIDWORKS MBD CommandManager to set up your model with selected configurations, including explodes and abbreviated views, annotations, display states, zoom level, view orientation and section views. Capture those settings so that you and other users can return to them at any time using the 3D view palette.

To access the 3D View palette, click the 3D Views tab at the bottom of the SOLIDWORKS window or the SOLIDWORKS MBD tab in the CommandManager. The Capture 3D View button opens the Capture 3D View PropertyManager, where you specify the 3D view name, and the configuration, display state and annotation view to capture. See SOLIDWORKS help for additional information.

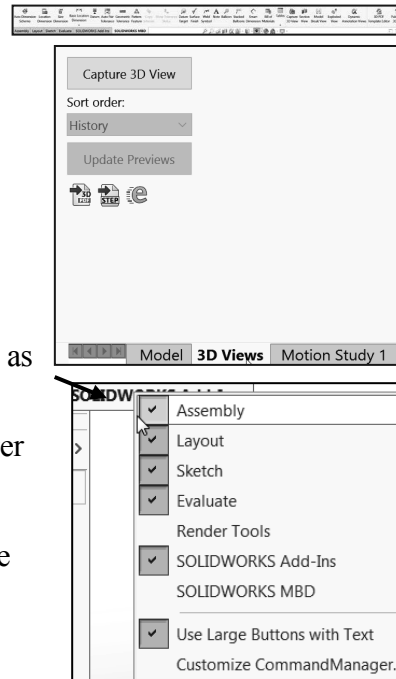

### Dynamic Reference Visualization (Parent/Child)

Dynamic Reference Visualization provides the ability to view the parent/child relationships between items in the FeatureManager design tree. When you hover over a feature with references in the FeatureManager design tree, arrows display showing the relationships. If a reference cannot be shown because a feature is not expanded, the arrow points to the feature that contains the reference and the actual reference appears in a text box to the right of the arrow.

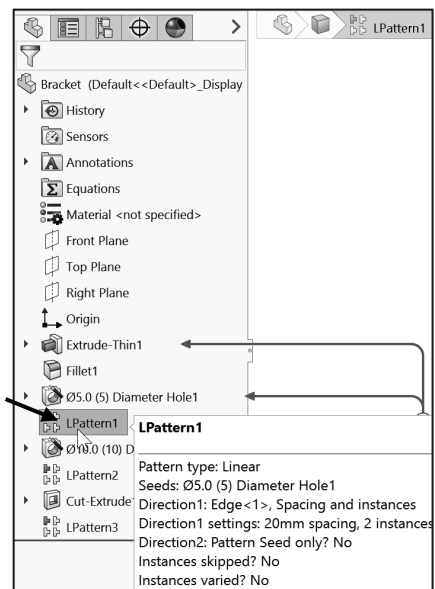

Use Dynamic reference visualization for a part, assembly and ever mates.

To display the Dynamic Reference Visualization, click **View > User Interface > Dynamic Reference Visualization** from the Main menu bar.

## Mouse Movements

A mouse typically has two buttons: a primary button (usually the left button) and a secondary button (usually the right button). Most mice also include a scroll wheel between the buttons to help you scroll through documents and to Zoom in, Zoom out and rotate models in SOLIDWORKS. It is highly recommended that you use a mouse with at least a Primary, Scroll and Secondary button.

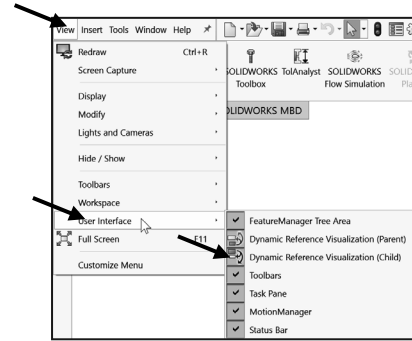
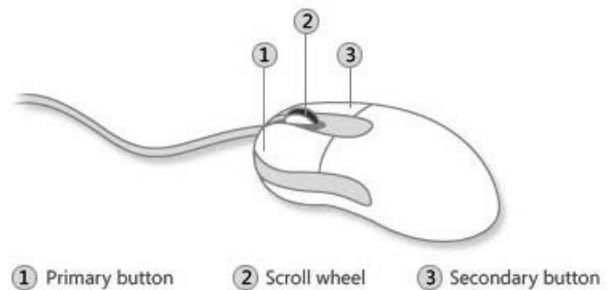

### Single-click

To click an item, point to the item on the screen, and then press and release the primary button (usually the left button). Clicking is most often used to select (mark) an item or open a menu. This is sometimes called single-clicking or left-clicking.

### Double-click

To double-click an item, point to the item on the screen, and then click twice quickly. If the two clicks are spaced too far apart, they might be interpreted as two individual clicks rather than as one double-click. Double-clicking is most often used to open items on your desktop. For example, you can start a program or open a folder by double-clicking its icon on the desktop.

### Right-click

To right-click an item, point to the item on the screen, and then press and release the secondary button (usually the right button). Right-clicking an item usually displays a list of things you can do with the item. Right-click in the open Graphics window or on a command in SOLIDWORKS, and additional pop-up context is displayed.

### Scroll wheel

Use the scroll wheel to zoom-in or to zoom-out of the Graphics window in SOLIDWORKS. To zoom-in, roll the wheel backward (toward you). To zoom-out, roll the wheel forward (away from you).

## Summary

The SOLIDWORKS 2018 User Interface and CommandManager consist of the following main options: Menu bar toolbar, Menu bar menu, Drop-down menus, Context toolbars, Consolidated fly-out menus, System feedback icons, Confirmation Corner and Heads-up View toolbar.

The default CommandManager Part tabs control the display of the *Features*, *Sketch*, *Evaluate*, *DimXpert* and *SOLIDWORKS Add-Ins* toolbars.

The FeatureManager consists of five default tabs:

- FeatureManager design tree.
- PropertyManager.
- ConfigurationManager.
- DimXpertManager.
- DisplayManager.

You learned about creating a new SOLIDWORKS part and opening an existing SOLIDWORKS part along with using the Rollback bar to view the sketches and features.

You also learned about SOLIDWORKS Help, SOLIDWORKS Tutorials and basic mouse movements to manipulate your SOLIDWORKS model.



Opening a SOLIDWORKS document from an earlier release can take extra time. After you open and save a file, subsequent opening time returns to normal. Use the SOLIDWORKS Task Scheduler (SOLIDWORKS Professional) to convert multiple files from an earlier version to the SOLIDWORKS 2018 format. Click Windows Start > All Apps > SOLIDWORKS 2018 > SOLIDWORKS Tools 2018 > SOLIDWORKS Task Scheduler.

Templates are part, drawing and assembly documents which include user-defined parameters. Open a new part, drawing or assembly. Select a template for the new document.

- **Parts.** The Parts default template is located in the C:\ProgramData\SolidWorks\SOLIDWORKS 2018\templates\Part.prtdot folder.
- **Assemblies.** The Assemblies default template is located in the C:\ProgramData\SolidWorks\SOLIDWORKS 2018\templates\Assembly.asmdot folder.

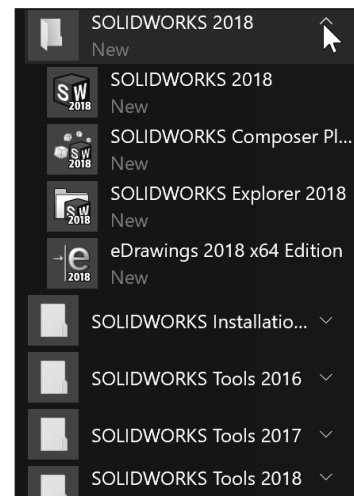

- **Drawings.** The Drawings default template is located in the C:\ProgramData\SolidWorks\SOLIDWORKS 2018\templates\Drawing.drwdot folder.

For commercial users, SOLIDWORKS Model Based Definition (MBD) is a separate application. For education users, SOLIDWORKS MBD is included in the SOLIDWORKS Education Edition as an Add In.

Redeem your code on the inside face of the book. View the provided videos and models to enhance the user experience.



In Chapter 2, establish a SOLIDWORKS session. Learn about 2D Sketching and 3D features.

Create a new part. Create the Wheel for the Fly Wheel sub-assembly. Utilize the Fly Wheel sub-assembly in the final Stirling Engine assembly.

Apply the following sketch and feature tools: Circle, Line Centerline, Centerpoint Straight Slot, Mirror Entities, Extruded Boss, Extruded Cut, Revolved Boss, Circular Pattern, Hole Wizard and Fillet.

Incorporate design change into a part using proper design intent, along with applying multiple geometric relations: Coincident, Vertical, Horizontal, Tangent and Midpoint and feature and sketch modifications.

Utilize the Material, Mass Properties and Appearance tool on the Wheel.

Videos	
Name	
	SOLIDWORKS_Basics_Videos 3 of 3.zip
	SOLIDWORKS_Basics_Videos 2 of 3.zip
	SOLIDWORKS_Basics_Videos 1 of 3.zip

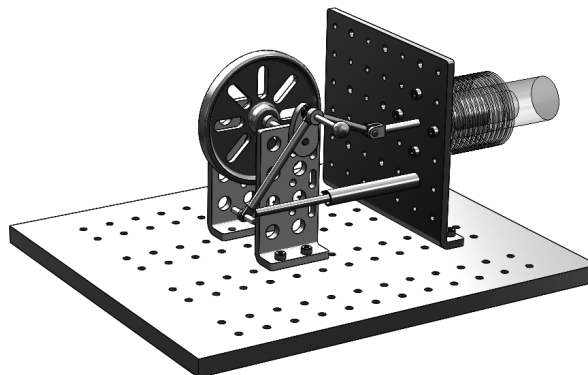
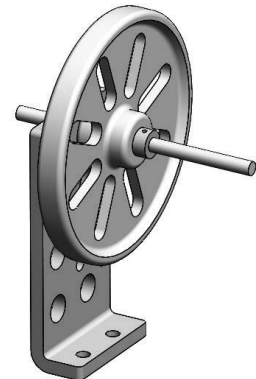

**Notes:**