

# Engineering Analysis

with SOLIDWORKS® Simulation 2018

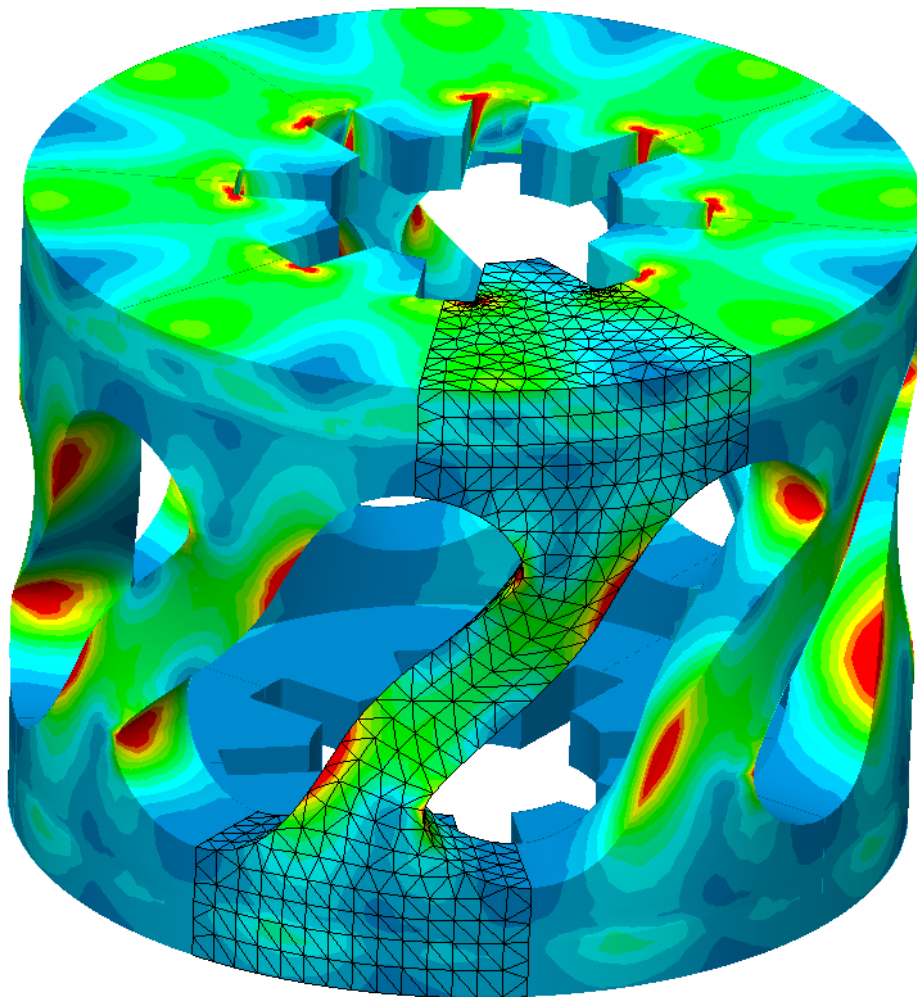

Paul M. Kurowski



Design Generator Inc.

CERTIFIED  
Solution  
Partner



Better Textbooks. Lower Prices.  
[www.SDCpublications.com](http://www.SDCpublications.com)

Visit the following websites to learn more about this book:



[amazon.com](https://www.amazon.com)

[Google books](https://books.google.com)

[BARNES & NOBLE](https://www.barnesandnoble.com)

## 2: Static analysis of a plate

---

### *Topics covered*

- ❑ Using the **SOLIDWORKS Simulation** interface
- ❑ Linear static analysis with solid elements
- ❑ Controlling discretization error with the convergence process
- ❑ Finding reaction forces
- ❑ Presenting FEA results in a desired format

### *Project description*

A steel plate is supported and loaded, as shown in Figure 2-1. We assume that the support is rigid (this is also called built-in support, fixed support or fixed restraint) and that a 100000N tensile load is uniformly distributed along the end face, opposite to the supported face.

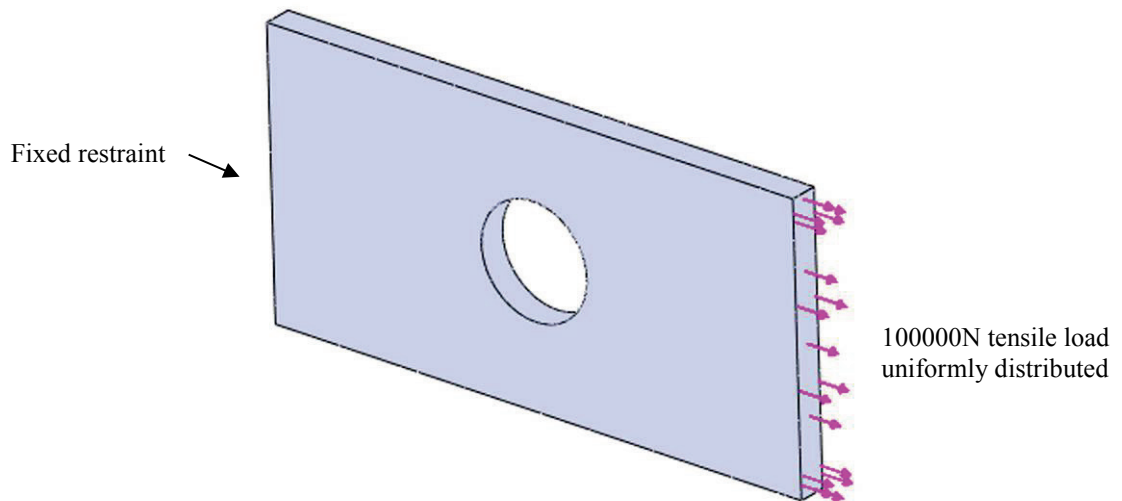

Figure 2-1: SOLIDWORKS model of a rectangular plate with a hole.

We will perform a displacement and stress analysis using meshes with different element sizes. Notice that repetitive analysis with different meshes does not represent standard practice in FEA. However, repetitive analysis with different meshes produces results which are useful in gaining more insight into how FEA works.

**Procedure**

In **SOLIDWORKS**, open the model file called HOLLOW PLATE. Verify that **SOLIDWORKS Simulation** is selected in the **Add-Ins** list (Figure 2-2).

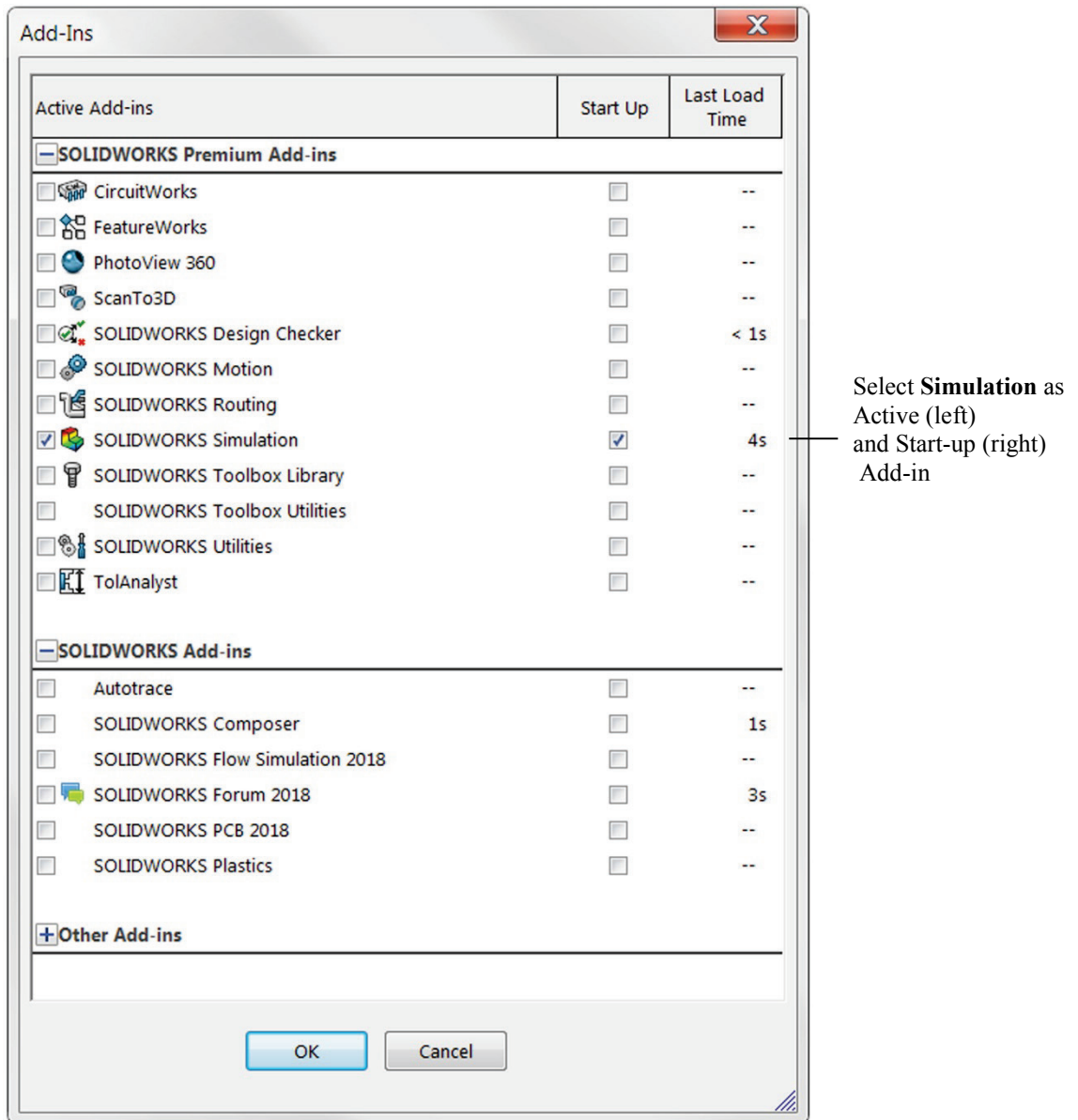

Figure 2-2: Add-Ins list in SOLIDWORKS.

Verify that **SOLIDWORKS Simulation** is selected in the list of Add-Ins.

Once **Simulation** has been added, it shows in the main **SOLIDWORKS** menu and in the Command Manager.

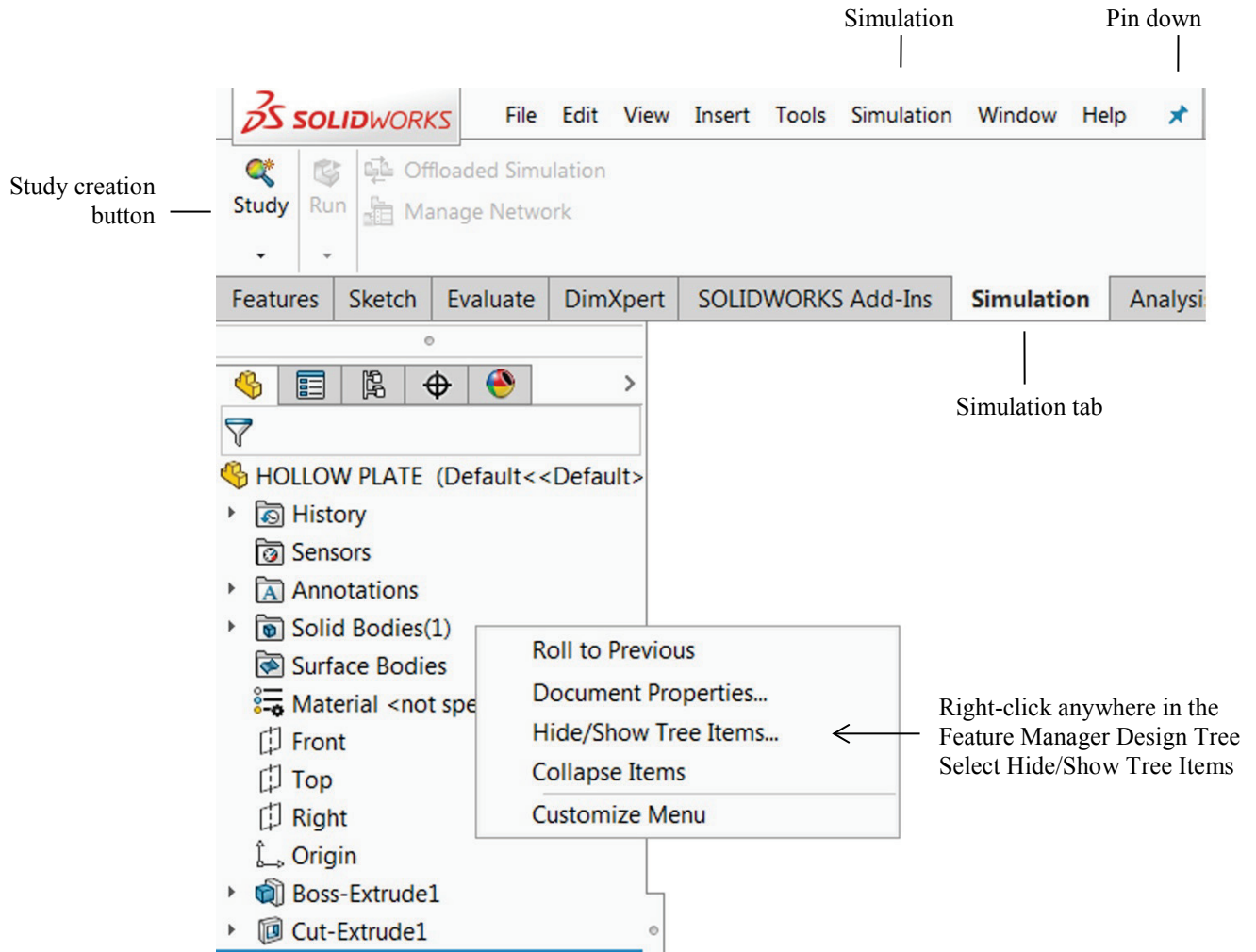

Figure 2-3: The Simulation tab is a part of the SOLIDWORKS Command Manager.

*Selecting the Simulation tab in the Command Manager displays Simulation menu items (icons). Since no study has been yet created, only the Study creation icon is available; all others are grayed-out. For convenience, pin down the top tool bar as shown. Command Manager with Large Buttons is shown in this illustration.*

Notice that **Feature Manager Design Tree** shown in Figure 2-3 displays **Solid Bodies** and **Surface Bodies** folders. These folders can be displayed by right-clicking anywhere in **Feature Manager Design Tree** to bring up the pop-up menu and selecting **Hide/Show Tree Items**. This will invoke **System Options-Feature Manager** (not shown here). From there, **Solid Bodies** and **Surface Bodies** folders can be selected to show (Figure 2-3). We will need to distinguish between these two different bodies in later exercises. In this exercise these two folders do not need to show.

Before we create a study, let's review the **Simulation** main menu (Figure 2-4) along with its **Options** window (Figure 2-5).

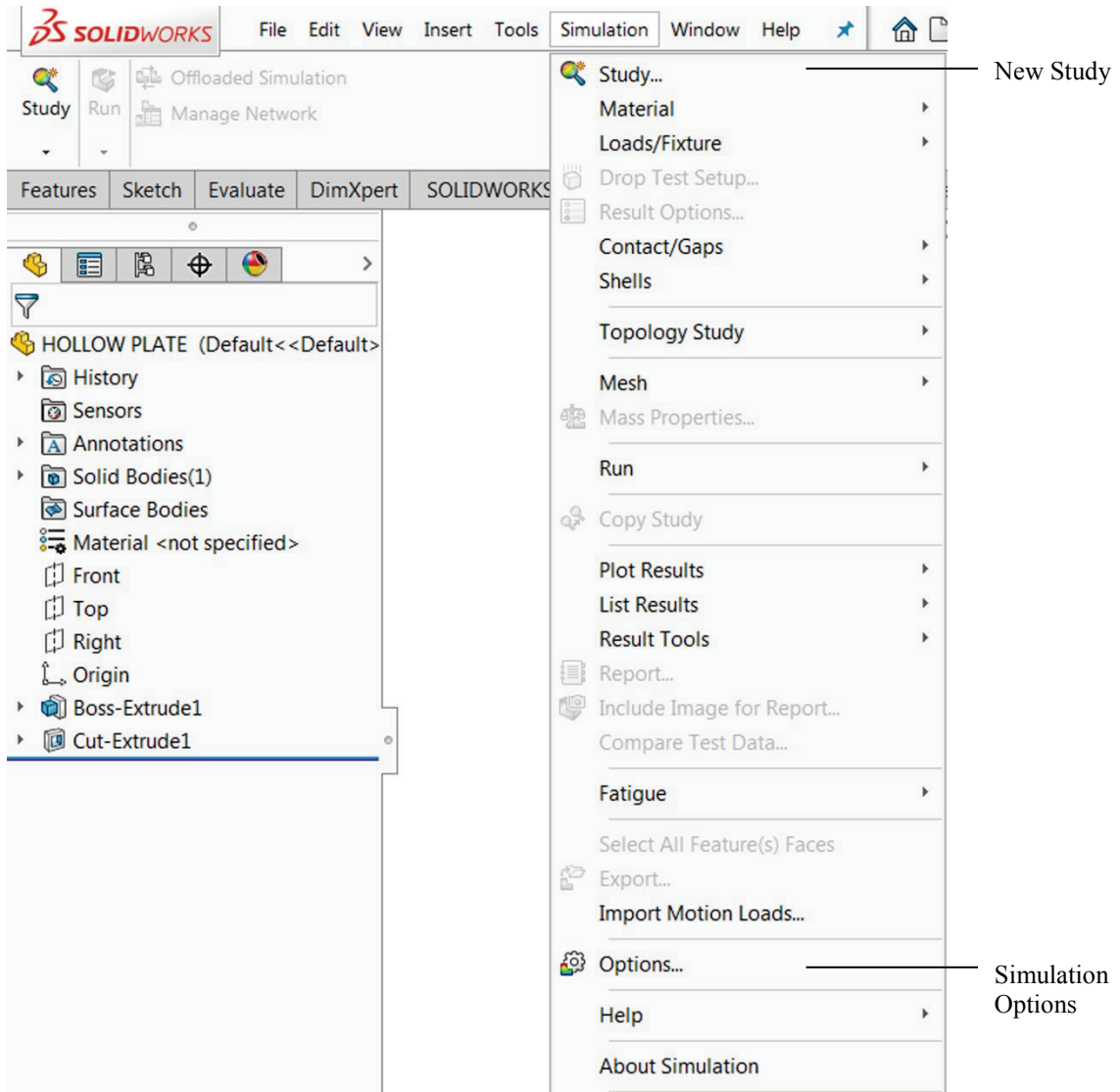

Figure 2-4: Simulation main menu.

*Similar to the Simulation Command Manager shown in Figure 2-3, only the New Study icon is available. Notice that some commands are available both in the Command Manager and in the Simulation menu.*

**Simulation** studies can be executed entirely from the **Simulation** drop down menu shown in Figure 2-4. In this book we will use the **Simulation** main menu and/or Command Manager to create a new Study. Everything else will be done in the Study Property Manager window.

Now click on the **Simulation** options shown in Figure 2-4 to open the **Simulation** System Options window shown in Figure 2-5.

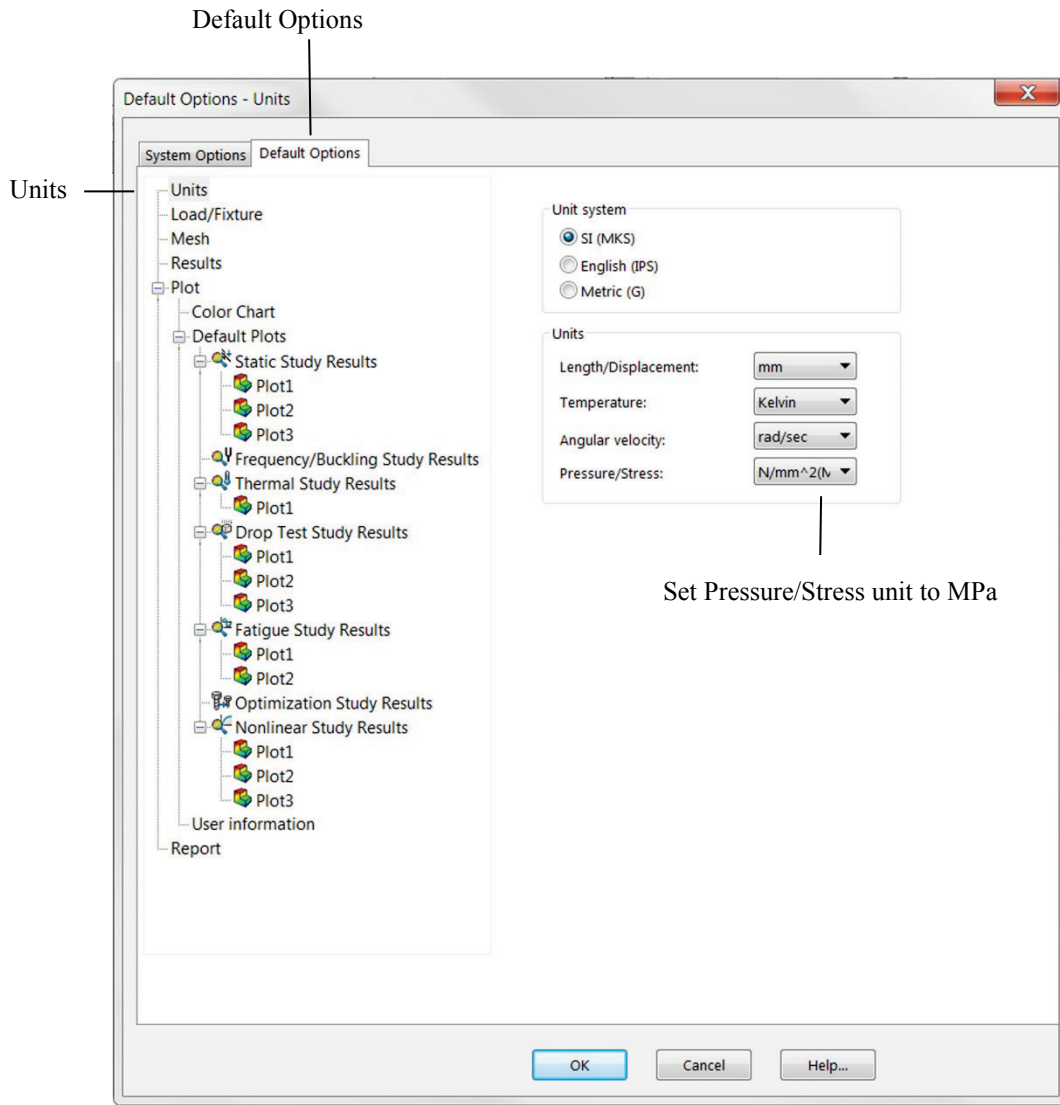

Figure 2-5: Simulation Options window.

The Options window has two tabs. In this example, **Default Options** and **Units** are selected and shown.

Please spend time reviewing all of the options in both System Options and Default Options shown in Figure 2-5 before proceeding with the exercise. In the **Units** options, make the choices shown in Figure 2-5. In this book we will mostly use the SI system of units using MPa rather than Pa as a unit of stress and pressure. Occasionally we will switch to the IPS system.

Notice that **Default Plots** can be added, modified, deleted or grouped into sub-folders which are created by right-clicking on the results folders, for example, **Static Study Results** folder, **Thermal Study Results** folder, etc.

Creation of an FEA model starts with the definition of a study. To define a new study, select **New Study** in either the **Simulation** tab in the Command Manager (Figure 2.3) or **Simulation** main menu (Figure 2-4). This will open the **Study Property Manager**. Notice that the **New Study** icon in the **Simulation** Command Manager can be also used to open the **Study Advisor**. We won't be using the **Study Advisor** in this book. Name the study *tensile load 01* (Figure 2-6).

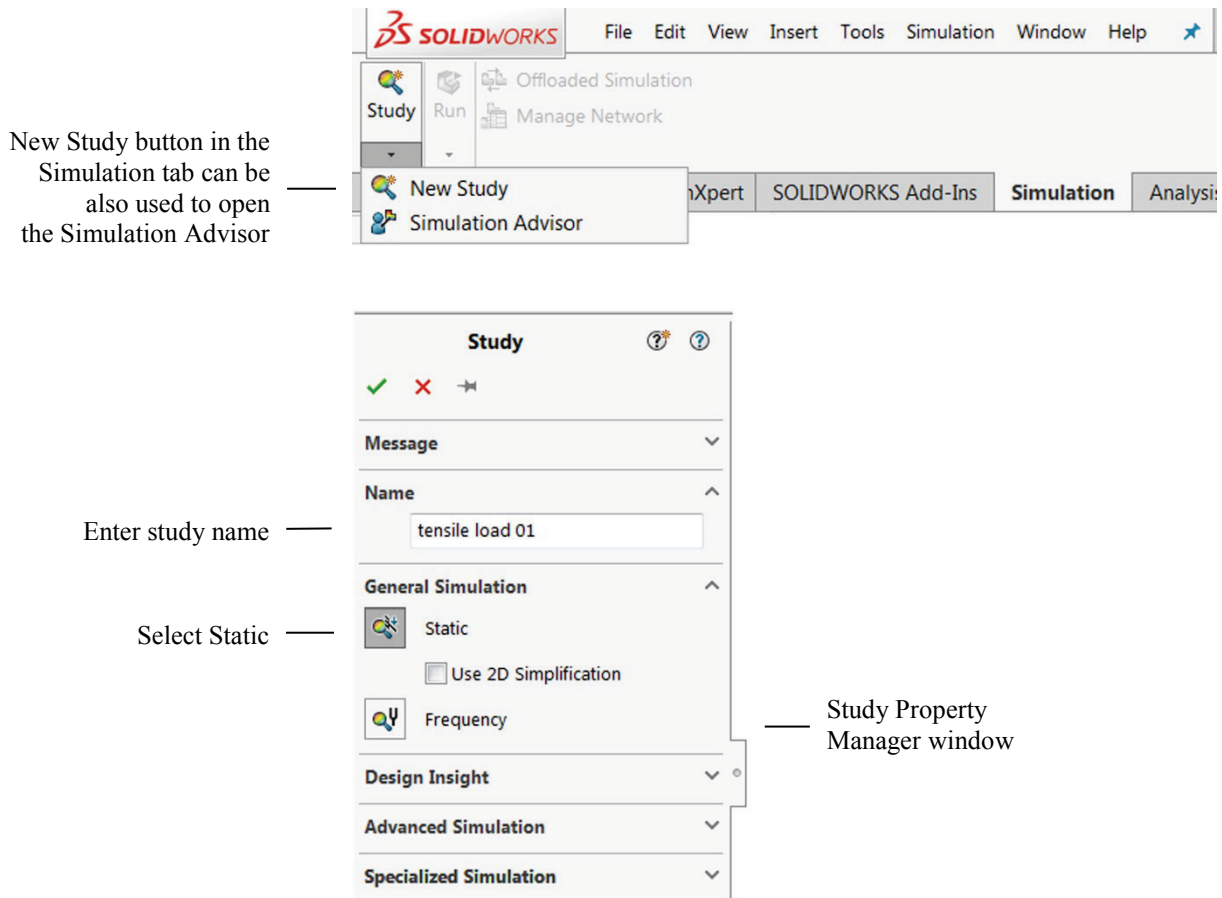

Figure 2-6: Creating a new study.

*The study definition window offers choices of the type of study; here we select Static. Static study and Frequency study belong to the group called General Simulation.*



Once a new study has been created, **Simulation** Commands can be invoked in three ways:

- ❑ From the Simulation Command Manager (Figure 2-4)
- ❑ From the Simulation main menu (Figure 2-4)
- ❑ By right-clicking appropriate items in the **Study Property Manager** window. In this book, we will most often use this method.

When a study is defined, **Simulation** creates a study window located below the **Feature Manager Design Tree** and places several folders in it. It also adds a study tab located next to **Model** and **Motion Study** tabs. The tab provides access to the study (Figure 2-7).

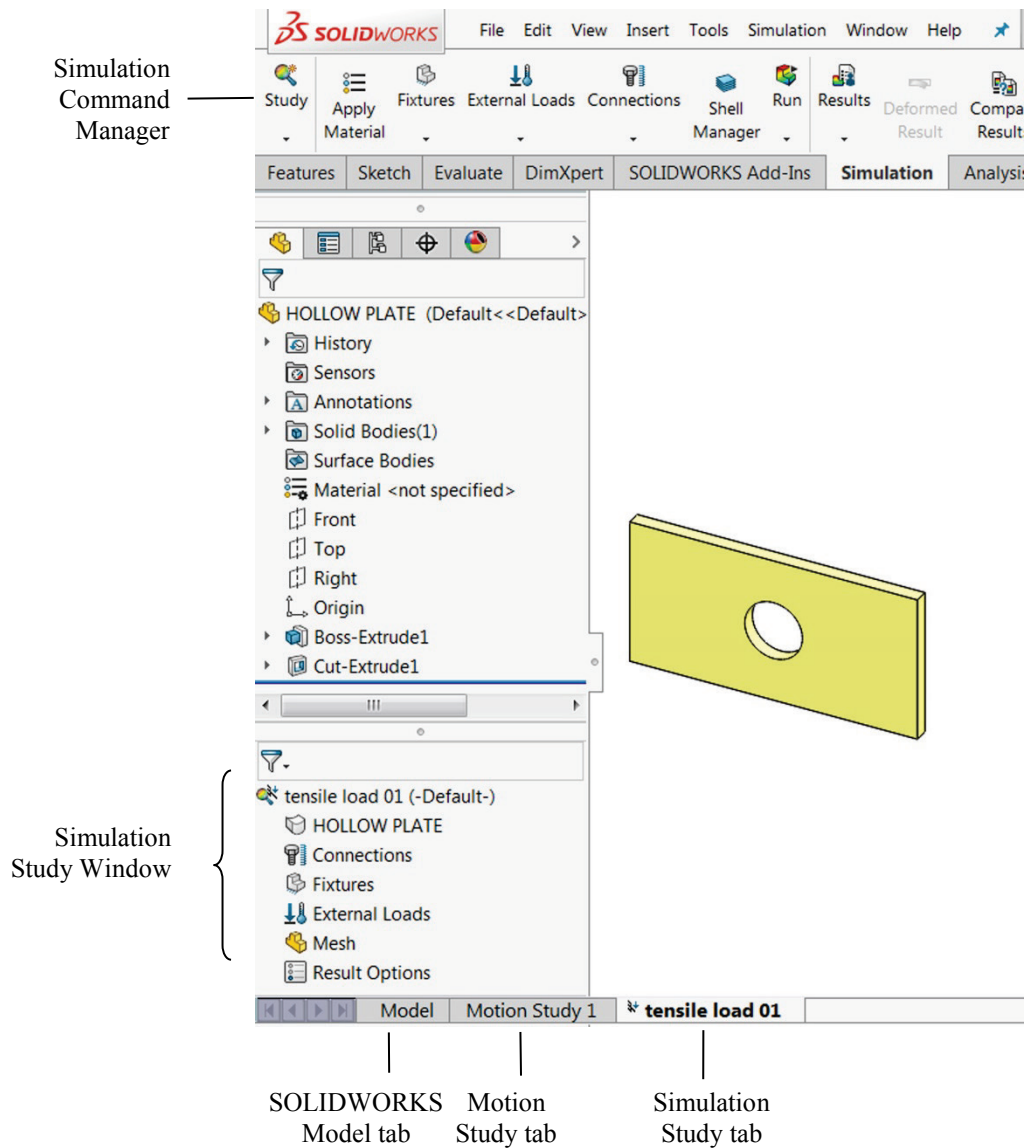

Figure 2-7: The Simulation window and Simulation tab.

*You can switch between the SOLIDWORKS Model, Motion Studies and Simulation Studies by selecting the appropriate tab.*

We are now ready to define the analysis model. This process generally consists of the following steps:

- CAD geometry idealization and/or simplification in preparation for analysis.  
This is usually done in **SOLIDWORKS** by creating an analysis specific configuration and making your changes there
- Material properties assignment
- Restraints application
- Load application

In this case, the geometry does not need any preparation because it is already very simple; we can start by assigning material properties.

Notice that if a material is defined for a **SOLIDWORKS** part model, the material definition is automatically transferred to the **Simulation** model. Assigning a material to the **SOLIDWORKS** model is actually a preferred modeling technique, especially when working with an assembly consisting of parts with different materials. We will do this in later exercises.

To apply material to the **Simulation** model, right-click the HOLLOW PLATE folder in the *tensile load 01* simulation study and select **Apply/Edit Material** from the pop-up menu (Figure 2-8).

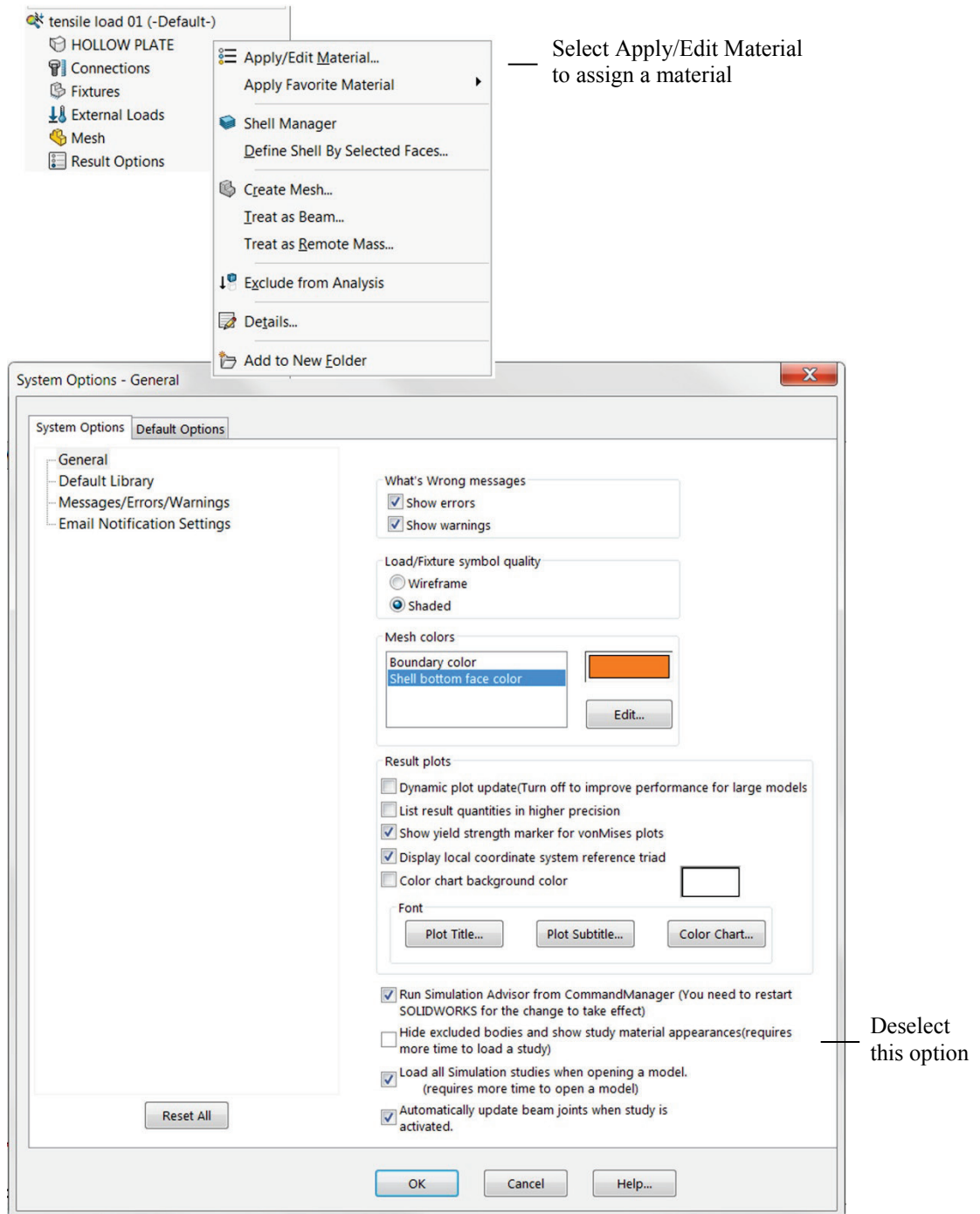

Figure 2-8: Assigning material properties.

The top window shows the first step in the process of applying material properties to the model.

The bottom window shows modification to System Options; this needs to be done only once.

The action in Figure 2-8 opens the **Material** window shown in Figure 2-9.

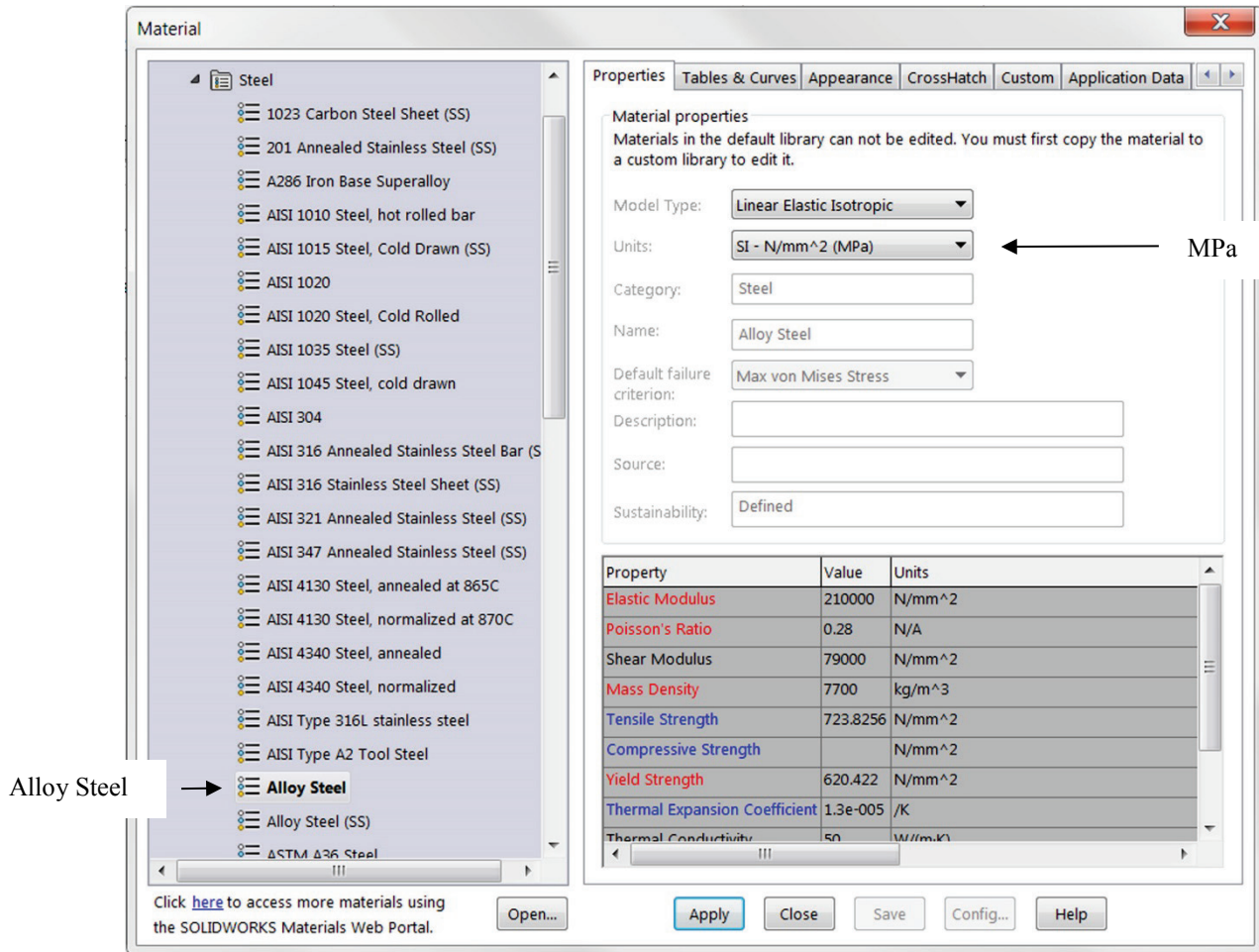

Figure 2-9: Material window.

*Select Alloy Steel to be assigned to the model; select MPa as units.*

*Click Apply, and then click Close.*

In the **Material** window, the properties are highlighted to indicate the mandatory and optional properties. A red color description (Elastic modulus, Poisson's ratio) indicates a property that is mandatory based on the active study type and the material model. A blue color description (Mass density, Tensile strength, Compressive strength, Yield strength, Thermal expansion coefficient) indicates optional properties. A black color description (Thermal conductivity, Specific heat, Material damping ratio) indicates properties not applicable to the current study.

In the **Material** window, open the **SOLIDWORKS Materials** menu, followed by the **Steel** menu. Select **Alloy Steel**. Select **SI** units under the **Properties** tab (other units could be used as well). Notice that the **HOLLOW PLATE** folder in the *tensile load 01* study now shows a check mark and the name of the selected material to indicate that a material has been assigned. If needed, you can define your own material by selecting **Custom Defined** material.

Defining a material consists of two steps:

- Material selection (or material definition if a custom material is used)
- Material assignment (either to all solids in the model, selected bodies of a multi-body part, or to selected components of an assembly)

Having assigned the material, we now move to defining the restraints. To display the pop-up menu that lists the options available for defining restraints, right-click the *Fixtures* folder in the *tensile load 01* study (Figure 2-10).

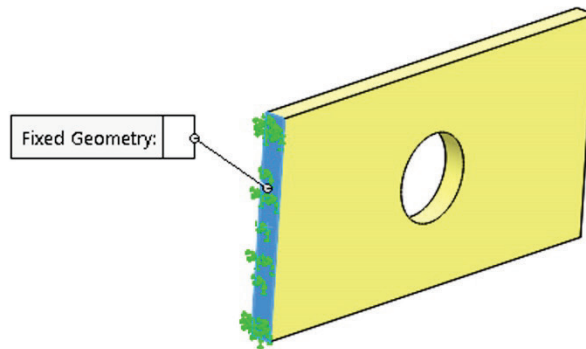
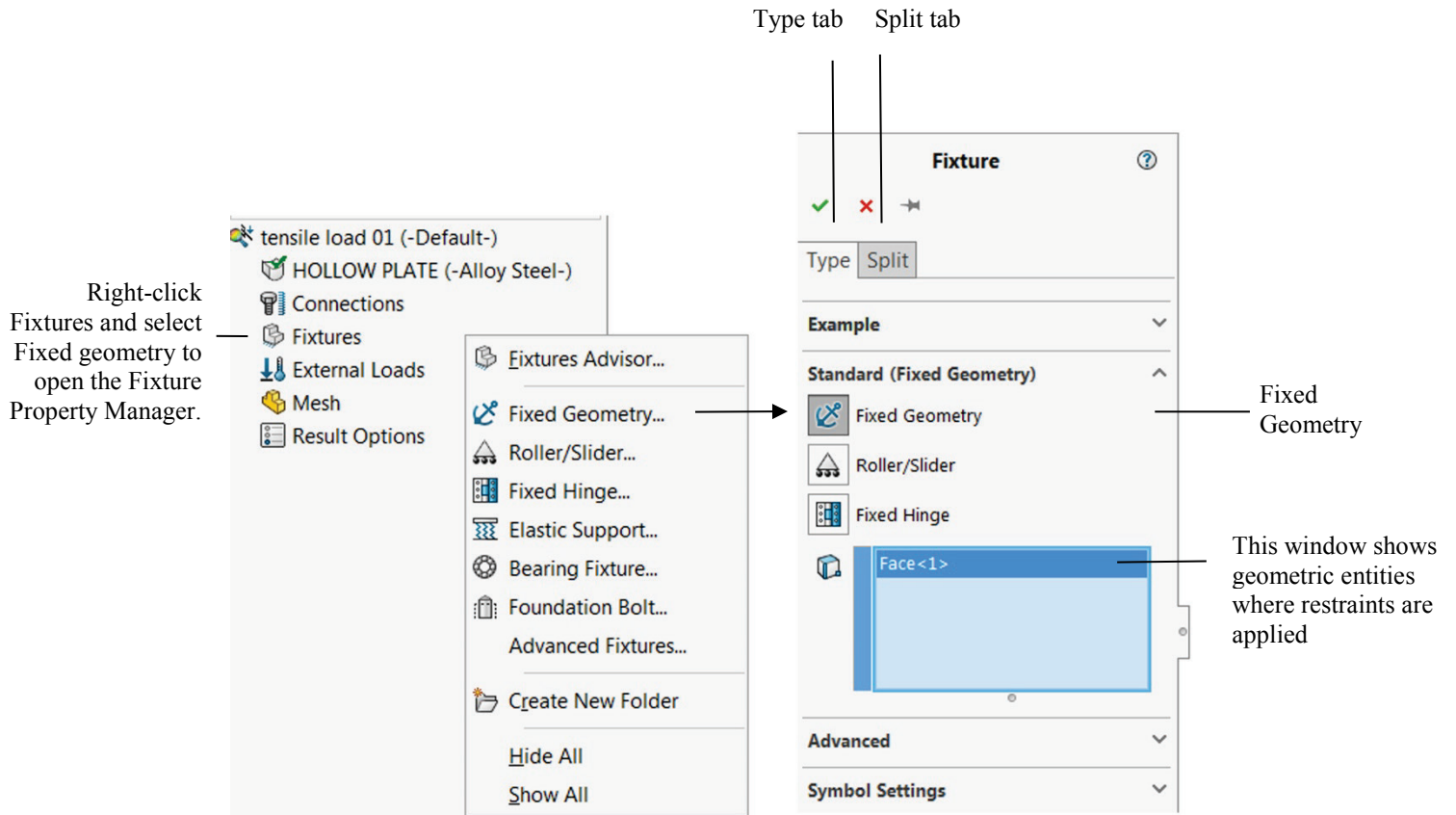

Figure 2-10: Pop-up menu for the Fixtures folder and Fixture definition window (Fixture Property Manager).

*All restraints' definitions are done in the Type tab. The Split tab is used to define a split face where restraints are applied. The same can be done in SOLIDWORKS by defining a Split Face.*

Once the **Fixtures** definition window is open, select the **Fixed Geometry** restraint type. Select the end-face entity where the restraint is to be applied. Click the green check mark in the Fixture Property manager window to complete the restraint definition.

Notice that in **SOLIDWORKS Simulation**, the term “Fixture” implies that the model is firmly “fixed” to the ground. However, aside from **Fixed Geometry**, which we have just used, all other types of fixtures restrain the model in certain directions while allowing movements in other directions. Therefore, the term “restraint” may better describe what happens when choices in the **Fixture** window are made. In this book we will switch between the terms “fixture” and “restraint” freely.

The existence of restraints is indicated by symbols shown in Figure 2-10. In the **Symbol** Settings of the Fixture window, the size of the symbol can be changed. Notice that symbols shown in Figure 2-10 are distributed over the highlighted face meaning the entire face has been restrained. Each symbol consists of three orthogonal arrows symbolizing directions where translations have been restrained. Each arrow has a disk symbolizing that rotations have also been restrained. The symbol implies that all six degrees of freedom (three translations and three rotations) have been restrained. However, the element type we will use to mesh this model (second order solid tetrahedral element) has only translational degrees of freedom. Rotational degrees of freedom can't be restrained because they don't exist in this type of element. Therefore, disks symbolizing restrained rotations are irrelevant in our model. Please see the following table for more explanations.

Before proceeding, explore other types of restraints accessible through the **Fixture** window. Restraints can be divided into two groups: **Standard** and **Advanced**. Review animated examples available in the **Fixture** window and review the following table. Some less frequently used types of restraints are not listed here.

<b>Standard Fixtures</b>	
<b>Fixed</b>	Also called built-in or rigid support. All translational and all rotational degrees of freedom are restrained.
<b>Immovable (No translations)</b>	Only translational degrees of freedom are restrained, while rotational degrees of freedom remain unrestrained. If solid elements are used (like in this exercise), <b>Fixed</b> and <b>Immovable</b> restraints would have the same effect because solid elements do not have rotational degrees of freedom. Therefore, the <b>Immovable</b> restraint is not available if solid elements are used alone.
<b>Roller/Slider</b>	Specifies that a planar face can move freely on its plane but not in the direction normal to its plane. The face can shrink or expand under loading.
<b>Fixed Hinge</b>	Applies only to cylindrical faces and specifies that the cylindrical face can only rotate about its own axis. This condition is identical to selecting the <b>On cylindrical face</b> restraint type and setting the radial and axial components to zero.
<b>Advanced Fixtures</b>	
<b>Symmetry</b>	Applies symmetry boundary conditions to a flat face. Translation in the direction normal to the face is restrained and rotations about the axes aligned with the face are restrained.
<b>Cyclic symmetry</b>	Allows analysis of a model with cyclic patterns around an axis by modeling a representative segment. The geometry, restraints, and loading conditions must be identical for all other segments making up the model. Turbine, fans, flywheels, and motor rotors can usually be analyzed using cyclic symmetry.
<b>Use Reference Geometry</b>	Restraints a face, edge, or vertex only in certain directions, while leaving the other directions free to move. You can specify the desired directions of restraint in relation to the selected reference plane or reference axis.
<b>On Flat Faces</b>	Provides restraints in selected directions, which are defined by the three directions of the flat face where restraints are being applied.
<b>On Cylindrical Faces</b>	This option is similar to <b>On flat face</b> , except that the three directions of a cylindrical face define the directions of restraints.
<b>On Spherical Face</b>	Similar to <b>On Flat Faces</b> and <b>On Cylindrical Faces</b> . The three directions of a spherical face define the directions of the applied restraints.



When a model is fully supported (as it is in our case), we say that the model does not have any rigid body motions (the term “rigid body modes” is also used), meaning it cannot move without experiencing deformation.

Notice that the presence of restraints in the model is manifested by both the restraint symbols (showing on the restrained face) and by the automatically created icon, **Fixture-1**, in the *Fixtures* folder. The display of the restraint symbols can be turned on and off by either:

- Right-clicking the *Fixtures* folder and selecting **Hide All** or **Show All** in the pop-up menu shown in Figure 2-10, or
- Right-clicking the fixture icon and selecting **Hide** or **Show** from the pop-up menu.

Use the same method to control display of other **Simulation** symbols.

Now define the load by right-clicking the *External Loads* folder and selecting **Force** from the pop-up menu. This action opens the **Force** window as shown in Figure 2-11.

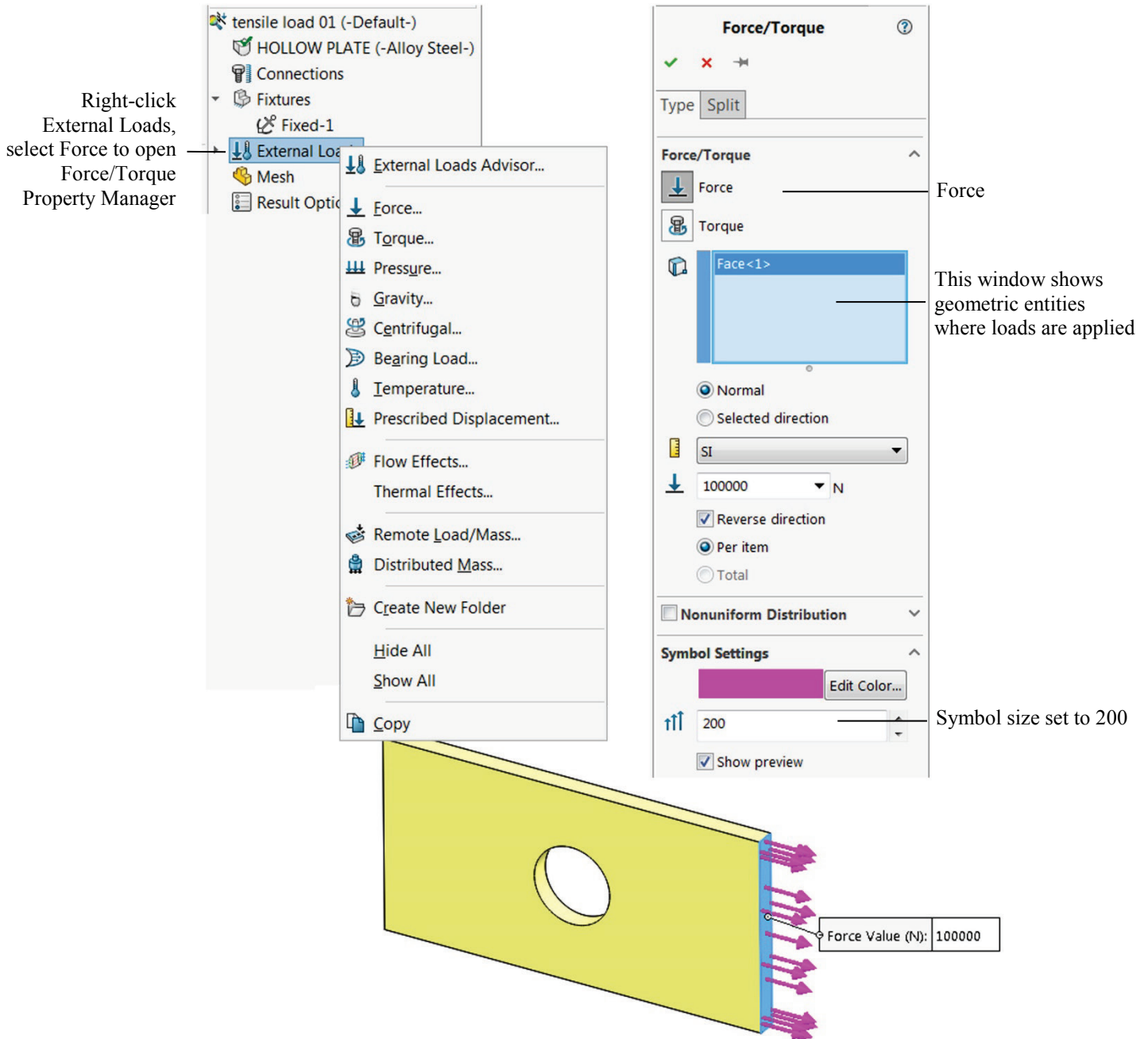

Figure 2-11: Pop-up menu for the External Loads folder and Force window.

*The Force window displays the selected face where the tensile force is applied. If only one entity is selected, there is no distinction between Per Item and Total. In this illustration, load symbols have been enlarged by adjusting the Symbols Settings. Symbols of previously defined restraints have been hidden.*

In the **Type** tab, select **Normal** in order to load the model with a 100000N tensile force uniformly distributed over the end face, as shown in Figure 2-11. Check the **Reverse direction** option to apply a tensile load.

Generally, forces can be applied to faces, edges, and vertices using different methods, which are reviewed below:

<b>Force normal</b>	Available for flat faces only, this option applies load in the direction normal to the selected face.
<b>Force selected direction</b>	This option applies a force or a moment to a face, edge, or vertex in the direction defined by the selected reference geometry. Moments can be applied only if shell elements are used. Shell elements have six degrees of freedom per node: three translations and three rotations, and can take a moment load. Solid elements only have three degrees of freedom (translations) per node and, therefore, cannot take a moment load directly. If you need to apply moments to solid elements, they must be represented with appropriately applied forces.
<b>Torque</b>	This option applies torque (expressed by traction forces) about a reference axis using the right-hand rule.

Try using the click-inside technique to rename the **Fixture-1** and **Force/Torque-1** items. Notice that renaming using the click-inside technique works on all items in **SOLIDWORKS Simulation**.

The model is now ready for meshing. Before creating a mesh, let's make a few observations about defining the geometry, material properties, loads and restraints.

Geometry preparation is a well-defined step with few uncertainties. Geometry that is simplified for analysis can be compared with the original CAD model.

Material properties are most often selected from the material library and do not account for local defects, surface conditions, etc. Therefore, the definition of material properties usually has more uncertainties than geometry preparation.

The definition of loads is done in a few menu selections but involves many assumptions. Factors such as load magnitude and distribution are often only approximately known and must be assumed. Therefore, significant idealization errors can be made when defining loads.

Defining restraints is where severe errors are most often made. For example, it is easy enough to apply a fixed restraint without giving too much thought to the fact that a fixed restraint means a rigid support – a mathematical abstraction. A common error is over-constraining the model, which results in an overly stiff structure that underestimates displacements and stresses. The relative level of uncertainties in defining geometry, material, loads, and restraints is qualitatively shown in Figure 2-12.

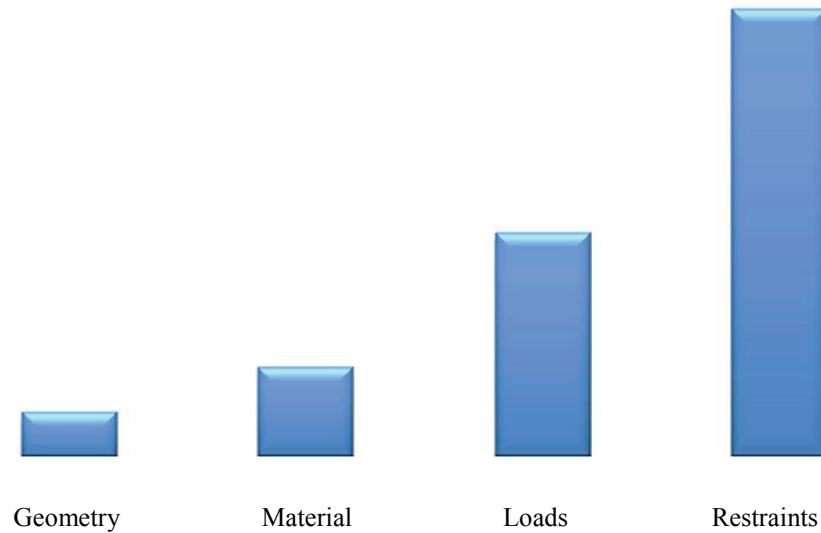

Figure 2-12: Qualitative comparison of uncertainty in defining geometry, material properties, loads, and restraints.

The level of uncertainty (or the risk of error) has no relation to time required for each step, so the message in Figure 2-12 may be counterintuitive. In fact, preparing CAD geometry for FEA may take hours, while defining material properties and applying restraints and loads takes only a few clicks.

In all of the examples presented in this book, we assume that definitions of material properties, loads, and restraints represent an acceptable idealization of real conditions. However, we need to point out that it is the responsibility of the FEA user to determine if all those idealized assumptions made during the creation of the mathematical model are indeed acceptable.

Before meshing the model, we need to verify under the **Default Options** tab, in the **Mesh** properties, that **High** mesh quality is selected (Figure 2-13). The **Options** window can be opened from the **SOLIDWORKS Simulation** menu as shown in Figure 2-4.

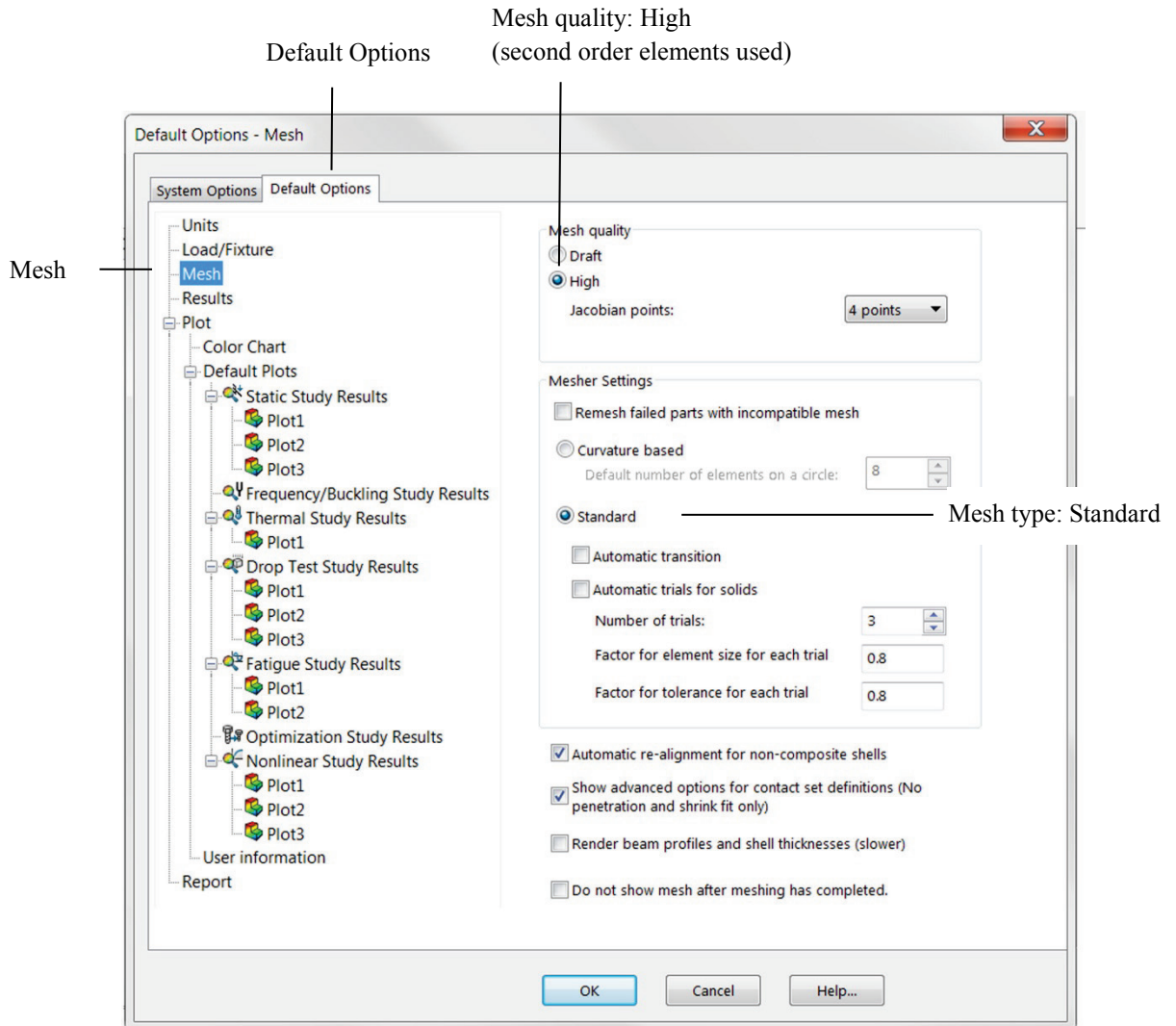

Figure 2-13: Mesh settings in the Options window.

*Use this window to verify that the mesh quality is set to High and the mesh type is set to Standard. Use these settings for other exercises unless indicated otherwise.*

The difference between **High** and **Draft** mesh quality is:

- Draft quality mesh uses first order elements
- High quality mesh uses second order elements

Differences between first and second order elements were discussed in chapter 1.

The difference between **Curvature based** mesh and **Standard** mesh will be explained in chapter 3. Now, right-click the *Mesh* folder to display the pop-up menu (Figure 2-14).

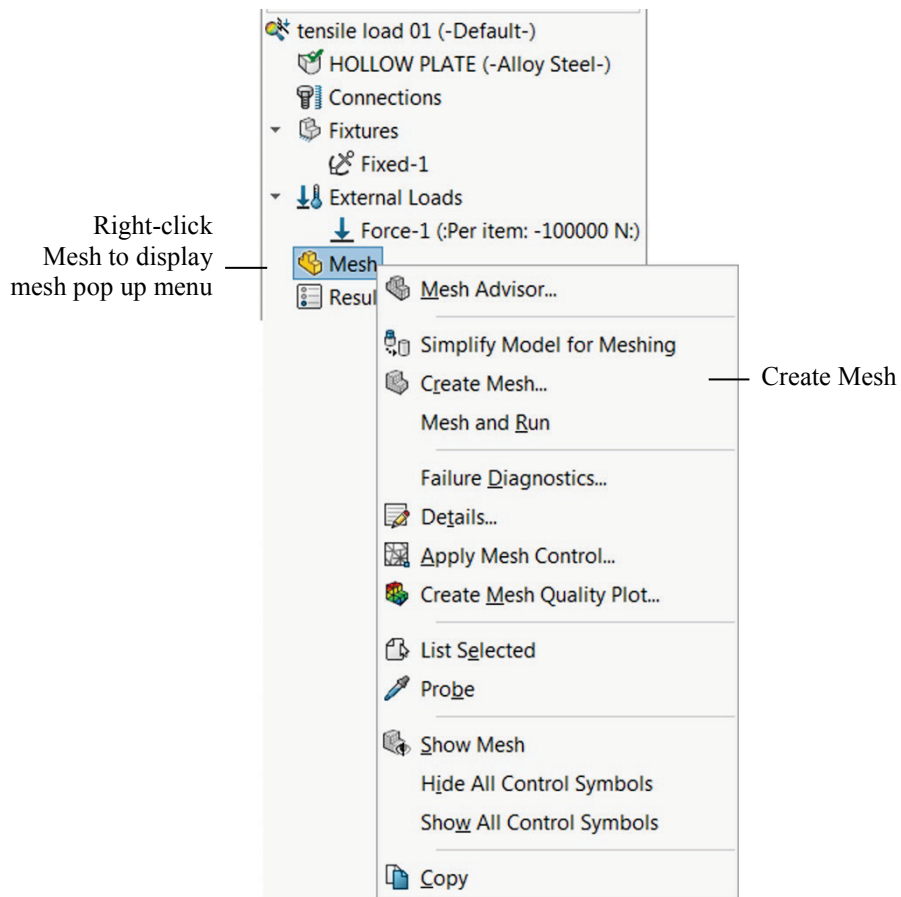
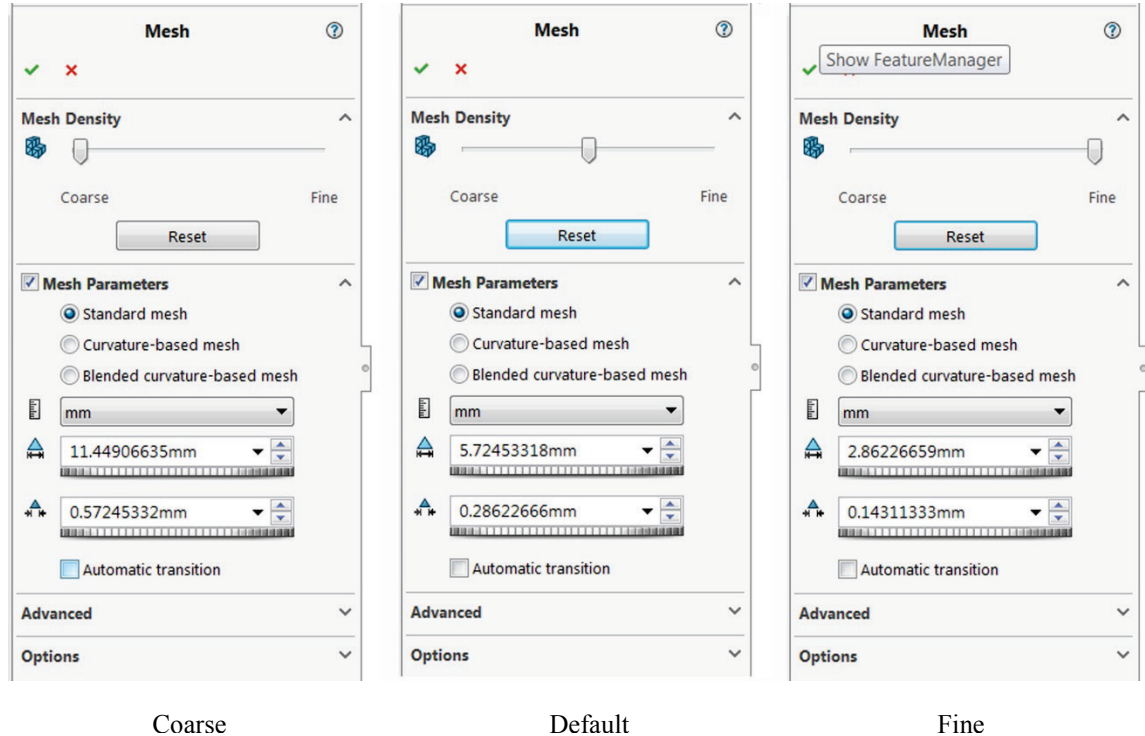

Figure 2-14: Mesh pop-up menu.

*Select Create Mesh from the pop-up menu.*

In the pop-up menu, select **Create Mesh**. This opens the **Mesh** window (Figure 2-15) which offers a choice of element size and element size tolerance.

This exercise reinforces the impact of mesh size on results. Therefore, we will solve the same problem using three different meshes: coarse, medium (default), and fine. Figure 2-15 shows the respective selection of meshing parameters to create the three meshes.



**Figure 2-15:** Three choices for mesh density from left to right: coarse, medium (default), and fine.

*Show Mesh Parameters to see the element size. In all three cases use Standard mesh. Notice the different slider positions in the three windows. Verify that standard mesh is used.*

The medium mesh density, shown in the middle window in Figure 2-15, is the default that **SOLIDWORKS Simulation** proposes for meshing our model. The element size of 5.72 mm and the element size tolerance of 0.286 mm are established automatically based on the geometric features of the **SOLIDWORKS** model. The 5.72 mm size is the characteristic element size in the mesh, as explained in Figure 2-16. The default tolerance is 5% of the global element size. If the distance between two nodes is smaller than this value, the nodes are merged unless otherwise specified by contact conditions; contact conditions are not present in this model.

Mesh density has a direct impact on the accuracy of results. The smaller the elements, the lower the discretization error, but the meshing and solving time both take longer. In the majority of analyses with **SOLIDWORKS Simulation**, the default mesh settings produce meshes that provide acceptable discretization errors, while keeping solution times reasonably short.

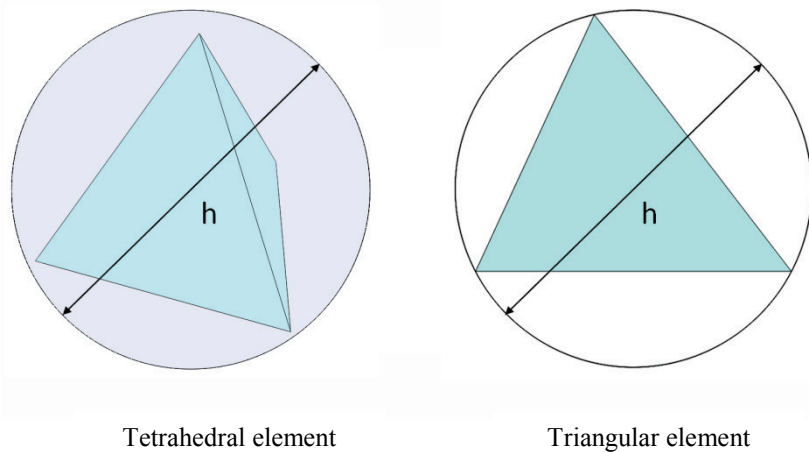

Figure 2-16: Characteristic element size for a tetrahedral element (left) and triangular element (right).

*The characteristic element size of a tetrahedral element is the diameter  $h$  of a circumscribed sphere (left). This is easier to illustrate with a 2D analogy of a circle circumscribed on a triangle (right).*

Right-click the Mesh folder again and select **Create...** to open the **Mesh** window. With the **Mesh** window open, set the slider all the way to the left (as illustrated in Figure 2-15, left) to create a coarse mesh, and click the green checkmark button. The mesh will be displayed as shown in Figure 2-17.

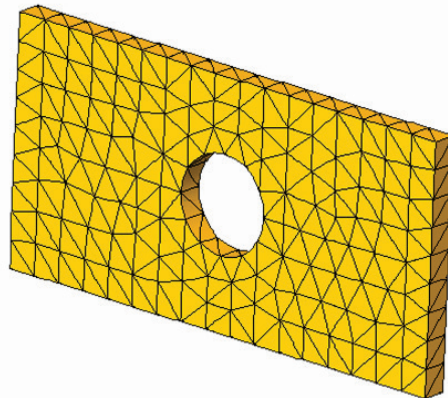

Figure 2-17: A coarse mesh created with second order, solid tetrahedral elements.

*You can control the mesh visibility by selecting **Hide Mesh** or **Show Mesh** from the pop-up menu shown in Figure 2-14.*



The presence of a mesh is reflected in the appearance of the solid folder and the mesh folder in a **Simulation** study (Figure 2-18).

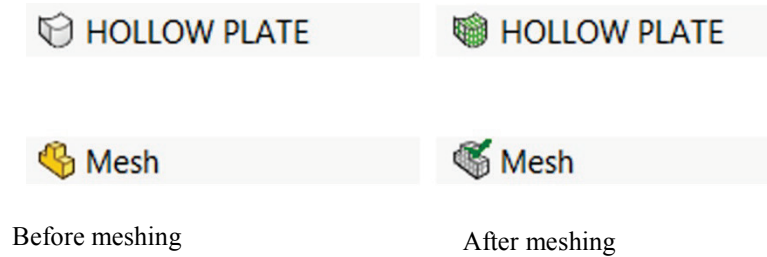

Figure 2-18: Solid folder and mesh folder in a Simulation study before and after meshing.

*After meshing, cross hatching is added to the Solid folder and cross-hatching and a green check mark is added to the Mesh folder.*

To start the solution, right-click the *tensile load 01* study folder which displays a pop-up menu (Figure 2-19). Select **Run** to start the solution.

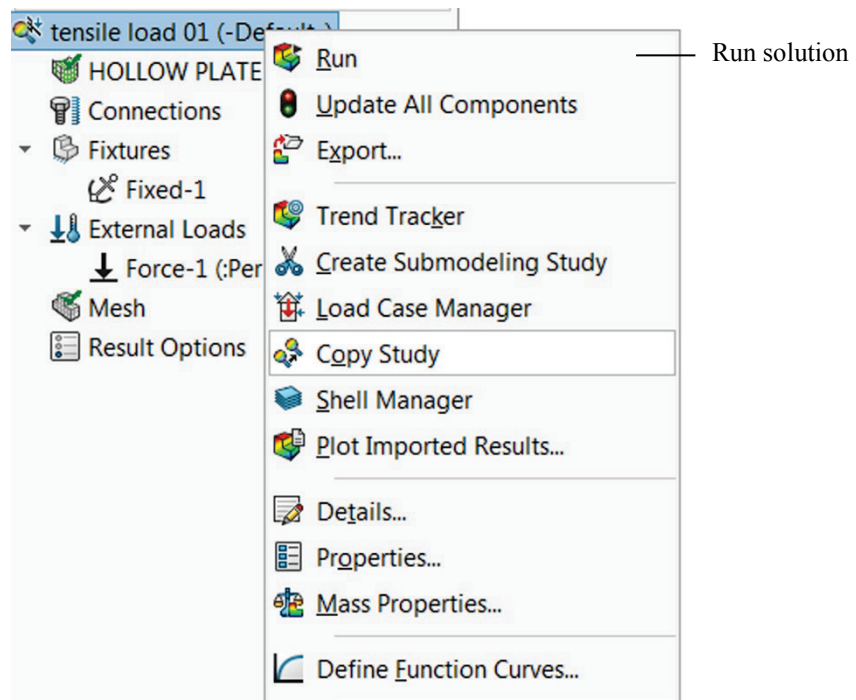

Figure 2-19: Pop-up menu for the *tensile load 01* folder.

*Start the solution by right-clicking the *tensile load 01* folder to display a pop-up menu. Select **Run** to start the solution.*

The solution can be executed with different properties, which we will investigate in later chapters. You can monitor the solution progress while the solution is running (Figure 2-20).

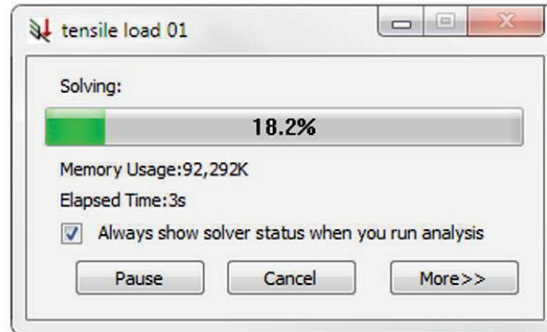

Figure 2-20: Solution Progress window.

*The solver reports solution progress while the solution is running.*

If the solution fails, the failure is reported as shown in Figure 2-21.

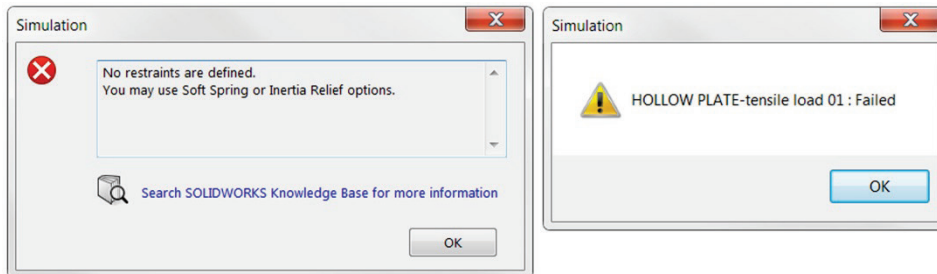

Figure 2-21: Failed solution warning windows.

*Here, the solution of a model with no restraints was attempted. Once the error message has been acknowledged (left), the solver displays the final outcome of the run (right).*

When the solution completes successfully, **Simulation** creates a *Results* folder with result plots which are defined in **Simulation Default Options** as shown in Figure 2-5.

In a typical configuration three plots are created automatically in the Static study; make sure that the above plots are defined in **Simulation** options, if not, define them:

- *Stress1* showing von Mises stresses
- *Displacement1* showing resultant displacements
- *Strain1* showing equivalent strain

Once the solution completes, you can add more plots to the *Results* folder. You can also create subfolders in the *Results* folder to group plots (Figure 2-22).

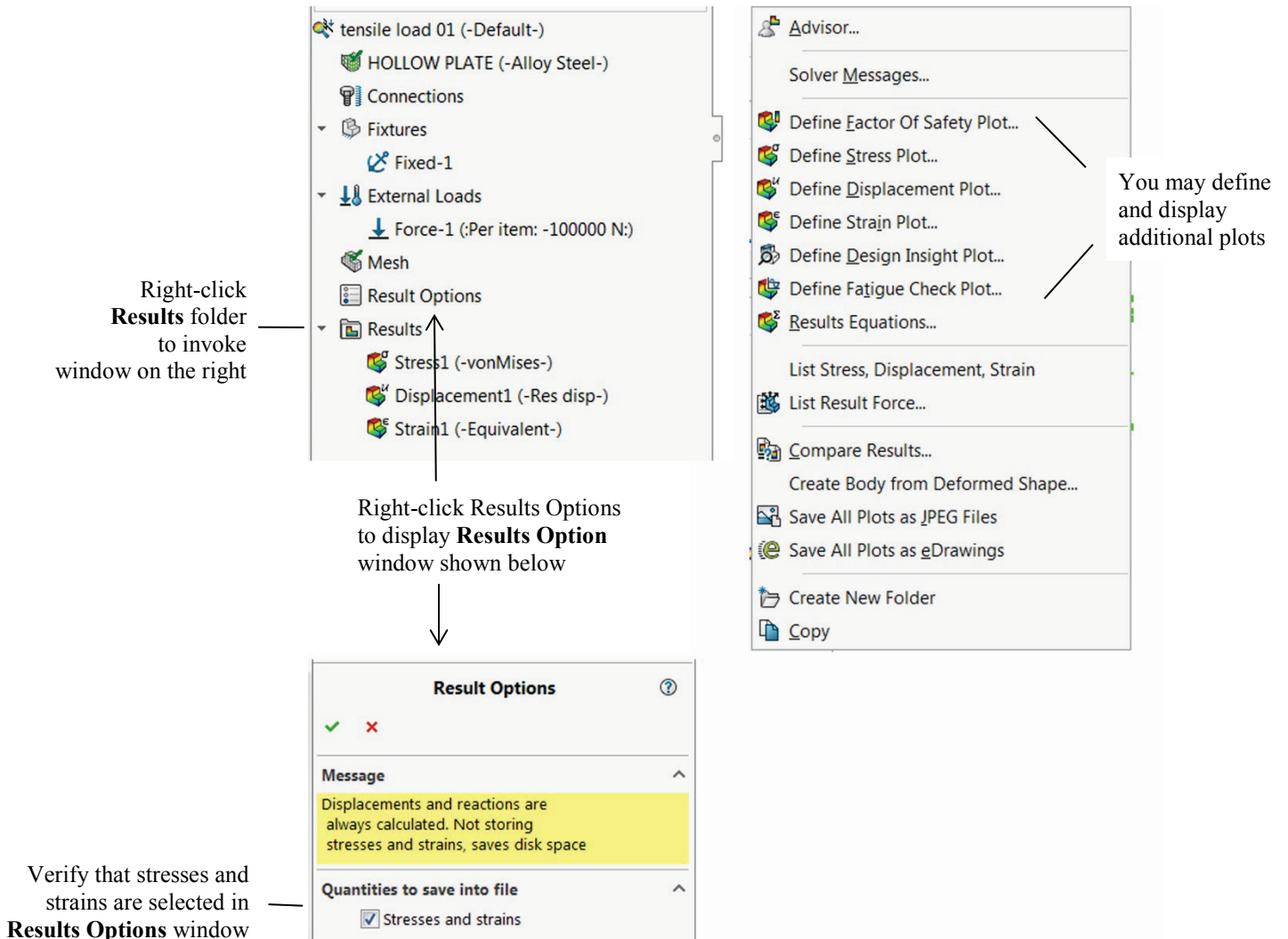

**Figure 2-22: More plots and folders can be added to the Results folder.**

*Right-clicking on the Results folder activates this pop-up menu from which plots may be added. Three plots are automatically created if Results Options include these three plots: Stress, Displacement, Strain.*

The **Result Options** window shown in Figure 2-22 has different choices depending on the type of study. In a **Static** study, deselecting **Stress and strain** disables calculation of stress and strain which reduces calculation time and the size of solution data base. This may be important in analysis of very large models.

To display stress results, double-click on the **Stress1** icon in the *Results* folder or right-click it and select **Show** from the pop-up menu. The stress plot is shown in Figure 2-23.

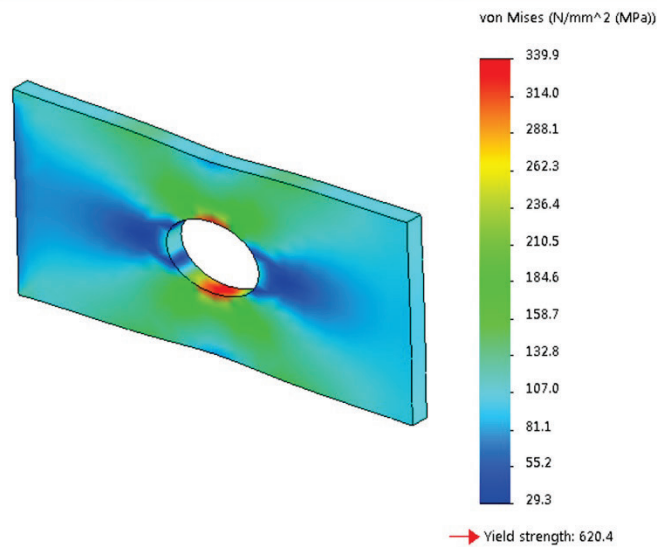
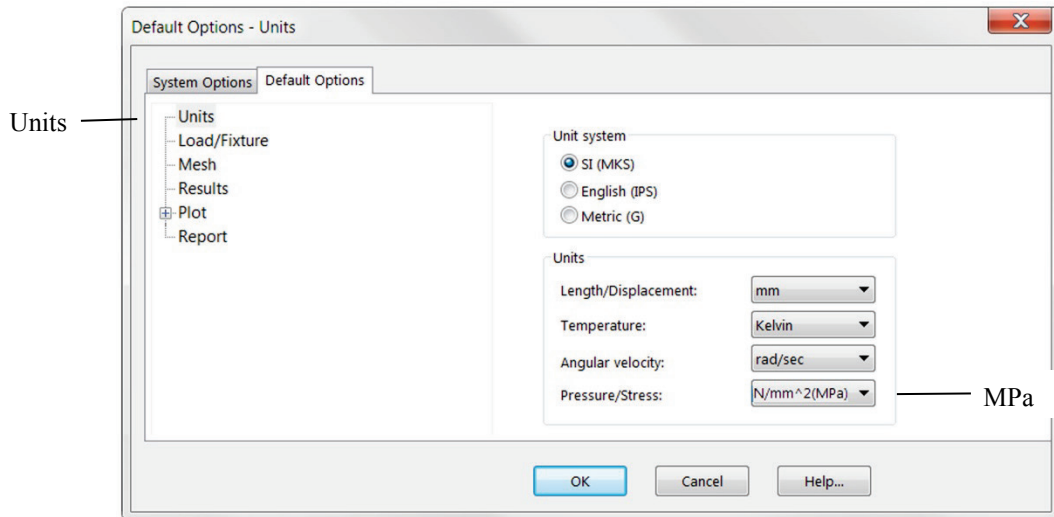
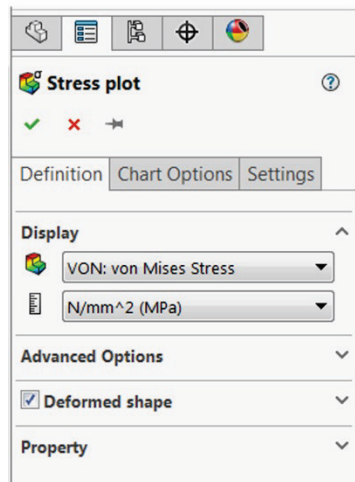
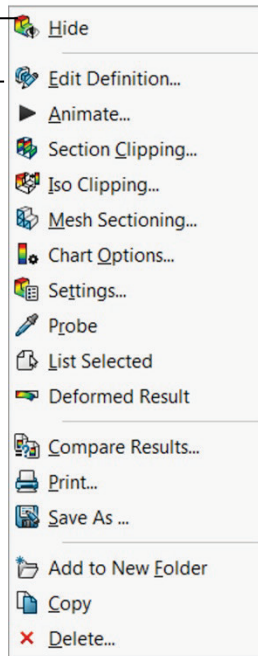

Figure 2-23: Stress plot displayed using default stress plot settings.

*Von Mises stress results are shown by default in the stress plot window. Notice that results are shown in [MPa] as was set in the Default Options tab shown in Figure 2-5 and repeated here in the top illustration. The highest stress 340 MPa is below the material yield strength, 620 MPa. The actual numerical results may differ slightly depending on the solver, software version, and service pack used.*

Once the stress plot is showing, right-click the stress plot icon to display the pop-up menu featuring different plot display options (Figure 2-24).

Right-click Results folder to display this menu  
 Select: one of the following:  
 Edit Definition  
 Chart Options  
 Settings



Definition

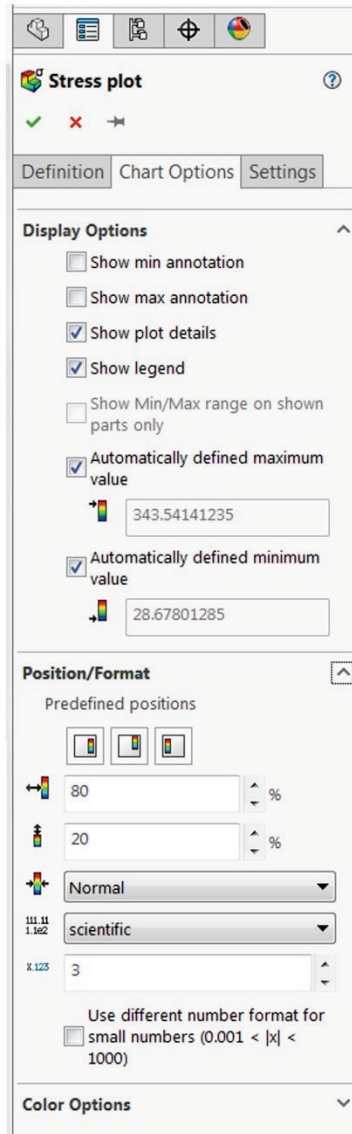
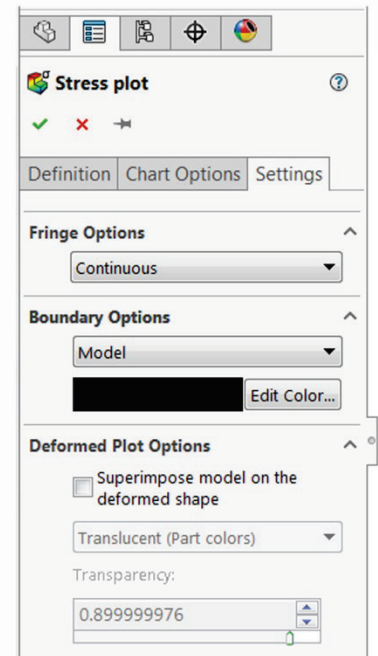

Chart Options



Settings

**Figure 2-24: Pop-up menu with plot display options.**

*Plots can be modified using selections from the pop-up menu (top). Callouts relate selections in the pop-up menu to the invoked windows. Color Options selection in Chart Options is not shown. The same menus may be invoked by right-clicking on the color legend of result plots.*

Explore all selections offered by these three windows shown in Figure 2-24. In particular, explore scientific, floating and general format options in **Chart Options** and color Options also in Chart Options. Notice that you may switch between **Definition**, **Chart Options** and **Settings** either by using the pop-up menu shown in Figure 2-24 or by using tabs at the top of these windows.

Use **Edit Definition** to change units if necessary. **Chart Options** offers control over the format of numerical results, such as scientific, floating, and general, and also offers a different number of decimal places. Explore these choices. In this book, results will be presented using different choices most suitable for the desired plot. In many plots in this book **Color Options** will be **User Defined** to replace dark blue color with grey color which shows better in print. Figure 2-24 shows the **User Defined** menu. Position of the color legend may be sometimes modified for improved layout.

The default type of **Fringe Options** in the **Settings** window is **Continuous** (Figure 2-24). Change this to **Discrete** through the **Default Options** window, by selecting **Plot** (Figure 2-5). This way you won't have to modify the future plots individually. In this book we will be using **Discrete Fringe Options** to display fringe plots. The plots from the current study will not change after changing the default options.

Since the above change does not affect already existing plots, we now examine how to modify the stress plot using the **Settings** window shown in Figure 2-25. In **Settings**, select **Discrete** in **Fringe options** and **Mesh** in **Boundary options** to produce the stress plot shown in Figure 2-25.

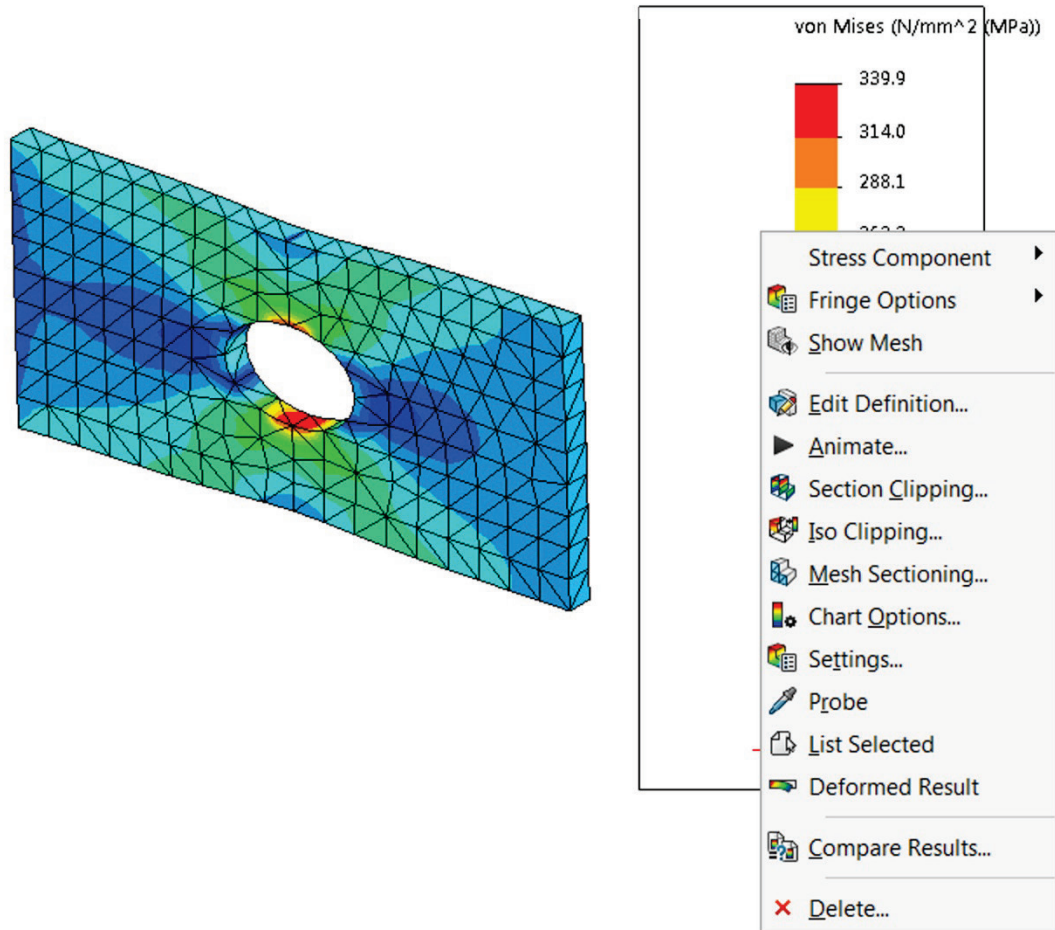

Figure 2-25: The modified stress plot is shown with discrete fringes and the mesh superimposed on the stress plot (top). Numbers use floating format with one decimal place. The plot also shows a shortcut menu that can be used to modify display options.

*Right-click the color bar to invoke the shortcut menu shown.*

The stress plot in Figure 2-25 shows node values, also called averaged stresses. Element values (or non-averaged stresses) can be displayed by proper selection in the **Stress Plot** window in **Advanced Options**. Node values are most often used to present stress results. See chapter 3 and the glossary of terms in chapter 23 for more information on node values and element values of stress results.

Before you proceed, investigate this stress plot with other selections available in the windows shown in Figure 2-24.

We now review the displacement and strain results. All of these plots are created and modified in the same way. Sample results are shown in Figure 2-26 (displacement) and Figure 2-27 (strain).

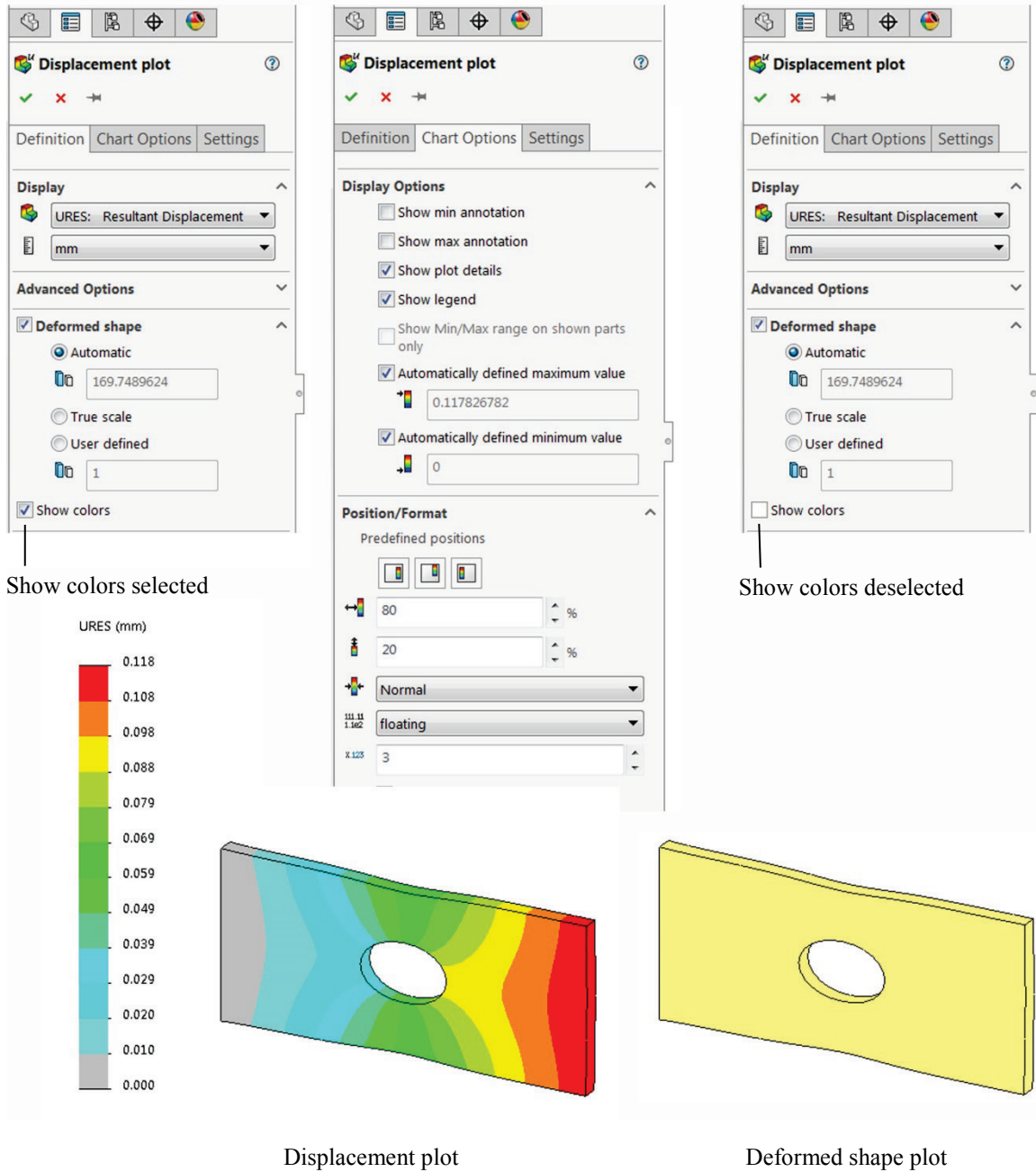

Figure 2-26: Displacement plot (left) and Deformation plot (right).

A Displacement plot can be turned into a Deformation plot by deselecting Show Colors in the Displacement Plot window. The same window has the option of showing the model with an exaggerated scale of deformation as shown above. Both plots have shown the deformed shape; this option may also be deselected. The blue color in the Displacement plot has been replaced with a gray color for better appearance in this illustration. That was done in Chart Options, Color Options, User defined.



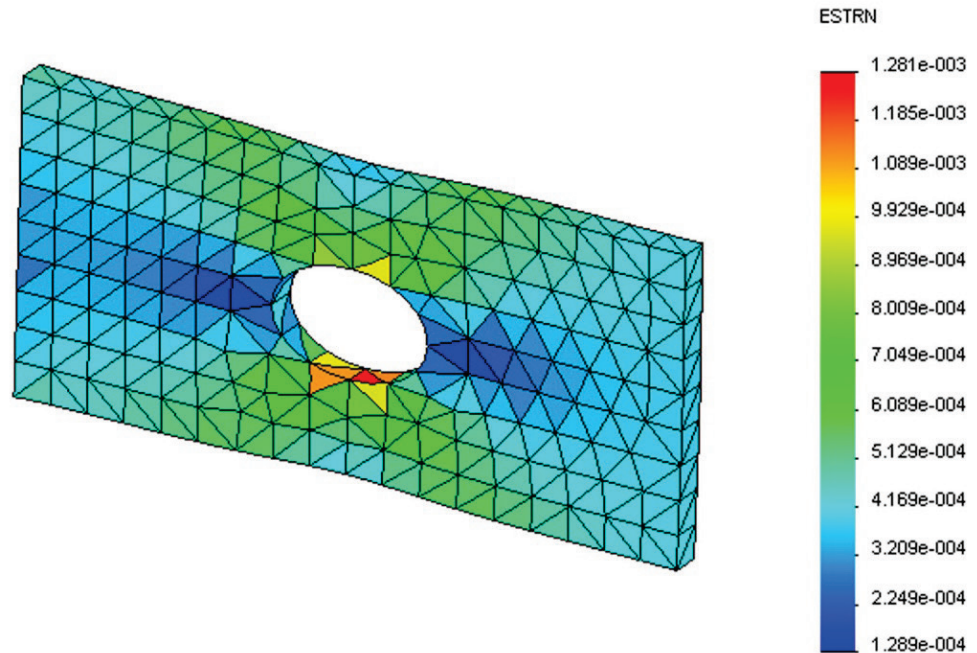
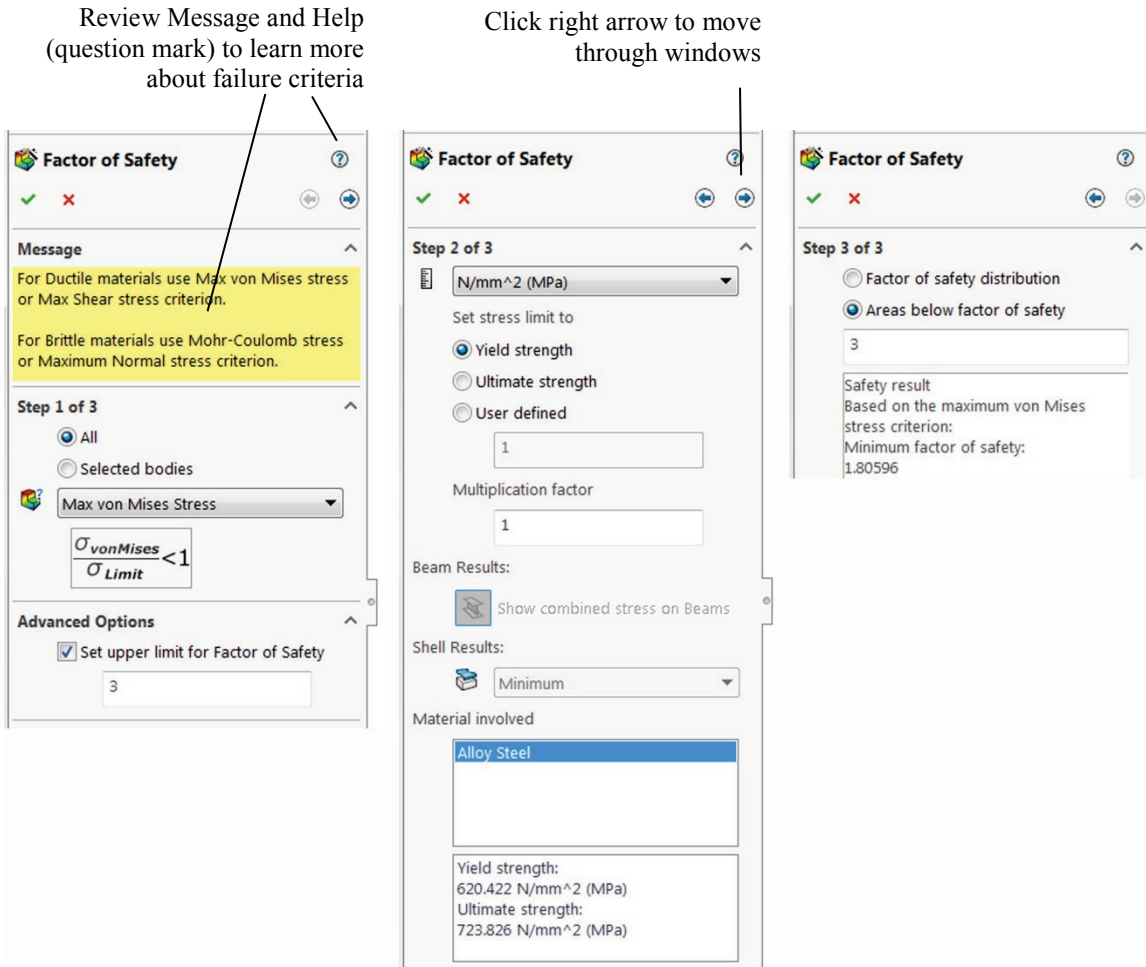

Figure 2-27: Strain results.

*Strain results are shown here using Element values. The mesh is also shown.*

The plots in Figures 2-23, 2-25, 2-26, 2-27 all show the deformed shape in an exaggerated scale. You can change the display from deformed to undeformed or modify the scale of deformation in the **Displacement Plot**, **Stress Plot**, and **Strain Plot** windows, activated by right-clicking the plot icon, then selecting **Edit Definition**.

Now, construct a **Factor of Safety** plot using the menu shown in Figure 2-22. The definition of the **Factor of Safety** plot requires three steps. Follow steps 1 through 3 using the selection shown in Figure 2-28. Refer to chapter 1 and review Help to learn about failure criteria and their applicability to different materials.



**Step 1**  
Use von Mises Stress criterion. Review Property options to insert text and/or use specific views for the plot.

**Step 2**  
Select multiplication factor.

**Step 3**  
Select “Areas below a factor of safety” and enter the number 3.

Figure 2-28: Three windows show the three steps in the Factor of Safety plot definition. Select the Max von Mises Stress criterion in the first window.

*To move through steps, click on the right and left arrows located at the top of the Factor of Safety dialog.*

*Step 1 selects the failure criterion, Step 2 selects display units, sets the stress limit and sets multiplication factor, and Step 3 selects what will be displayed in the plot. Here we select areas below the factor of safety 3.*

The factor of safety plot in Figure 2-29 shows the area where the factor of safety is below the specified.

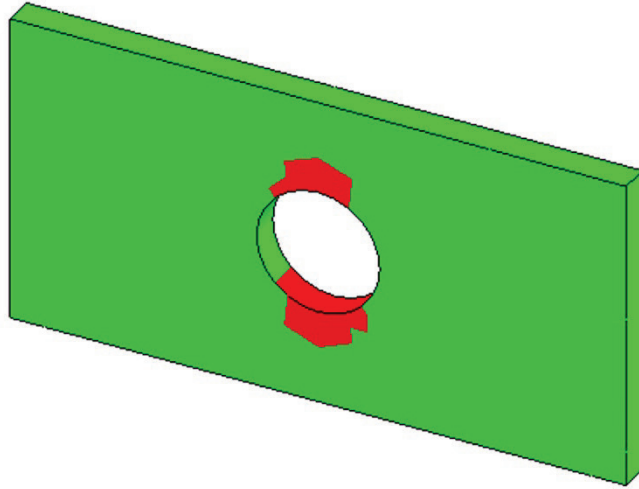

Figure 2-29: The red color displays the areas where the factor of safety falls below 3. Irregular shape of these areas is caused by the coarse mesh used in this study.

*Colors may be edited in Chart Options (Figure 2-26).*

We have completed the analysis with a coarse mesh and now wish to see how a change in mesh density will affect the results. Therefore, we will repeat the analysis two more times using medium and fine density meshes respectively. We will use the settings shown in Figure 2-15. All three meshes used in this exercise (coarse, medium, and fine) are shown in Figure 2-30.

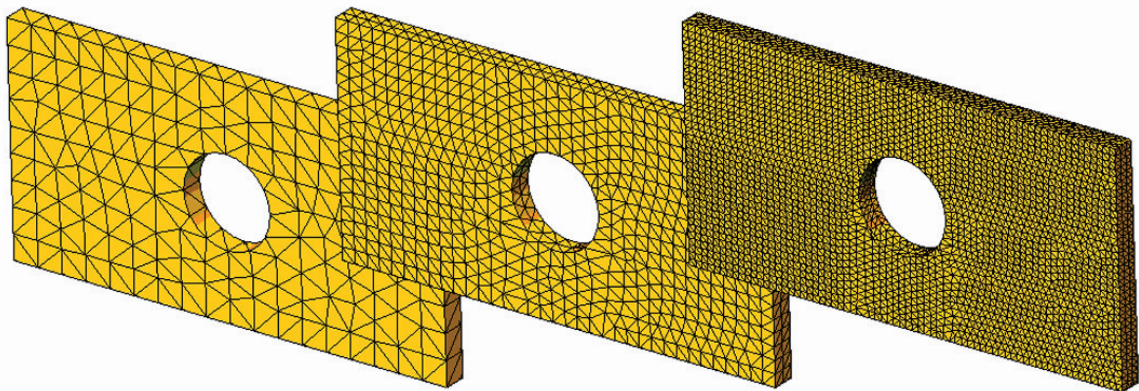

Figure 2-30: Coarse, medium, and fine meshes.

*Three meshes used to study the effects of element size on results.*

To compare the results produced by different meshes, we need more information than is available in the plots. Along with the maximum displacement and the maximum von Mises stress, for each study we need to know:

- The number of nodes in the mesh.
- The number of elements in the mesh.
- The number of degrees of freedom in the model.

The information on the number of nodes and number of elements can be found in **Mesh Details** accessible from the menu in Figure 2-14. The mesh Details window is shown in Figure 2-31.

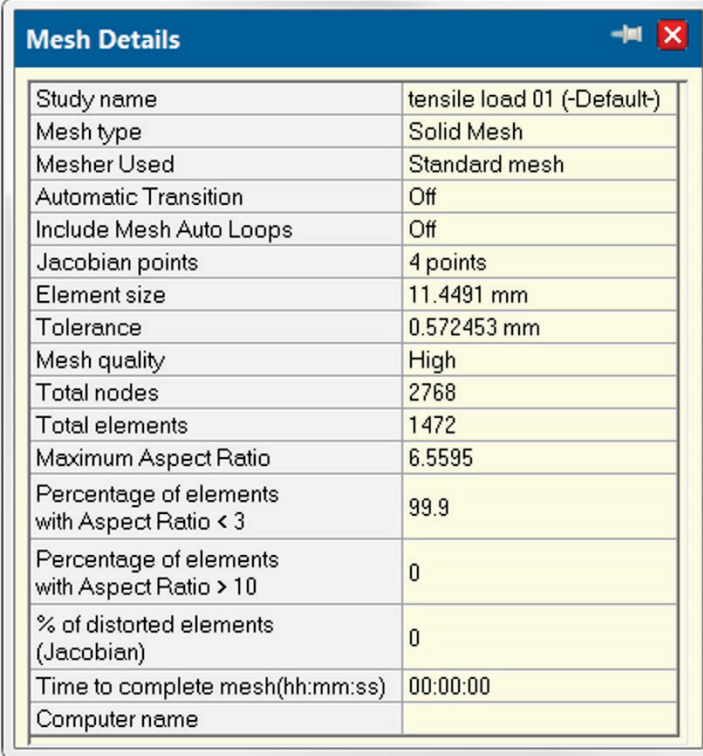

Mesh Details	
Study name	tensile load 01 (-Default)
Mesh type	Solid Mesh
Mesher Used	Standard mesh
Automatic Transition	Off
Include Mesh Auto Loops	Off
Jacobian points	4 points
Element size	11.4491 mm
Tolerance	0.572453 mm
Mesh quality	High
Total nodes	2768
Total elements	1472
Maximum Aspect Ratio	6.5595
Percentage of elements with Aspect Ratio < 3	99.9
Percentage of elements with Aspect Ratio > 10	0
% of distorted elements (Jacobian)	0
Time to complete mesh(hh:mm:ss)	00:00:00
Computer name	

Figure 2-31: Mesh details window.

*Right-click the Mesh folder and select Details from the pop-up menu to display the Mesh Details window. Notice that information on the number of degrees of freedom is not available here.*

Another way to find the number of nodes and elements and also the number of degrees of freedom is to use the pop-up menu shown in Figure 2-32. Right-click the *Results* folder and select **Solver Messages** to display the window shown in Figure 2-32.

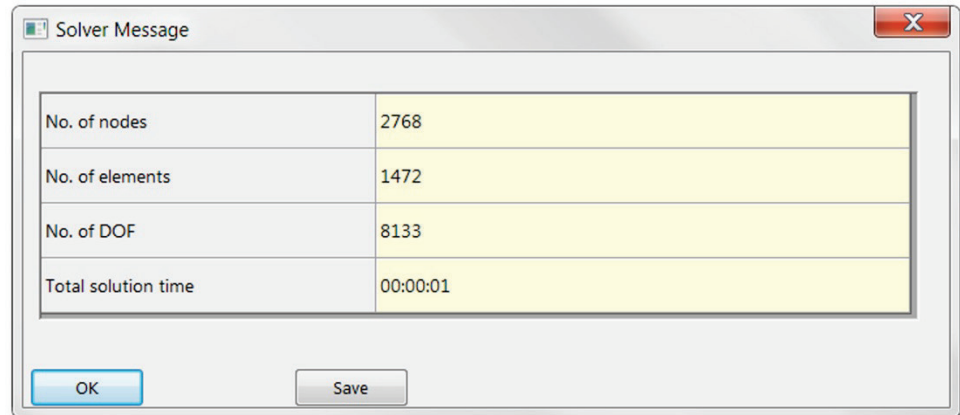

Figure 2-32: The Solver Message window lists information pertaining to the solved study.

*Click the Save button to save this solver message.*

Now create and run two more studies: *tensile load 02* with the default element size (medium), and *tensile load 03* with a fine element size, as shown in Figure 2-15 and Figure 2-30. To create a new study we could just repeat the same steps as before but an easier way is to copy the original study. To copy a study, follow the steps in Figure 2-33.

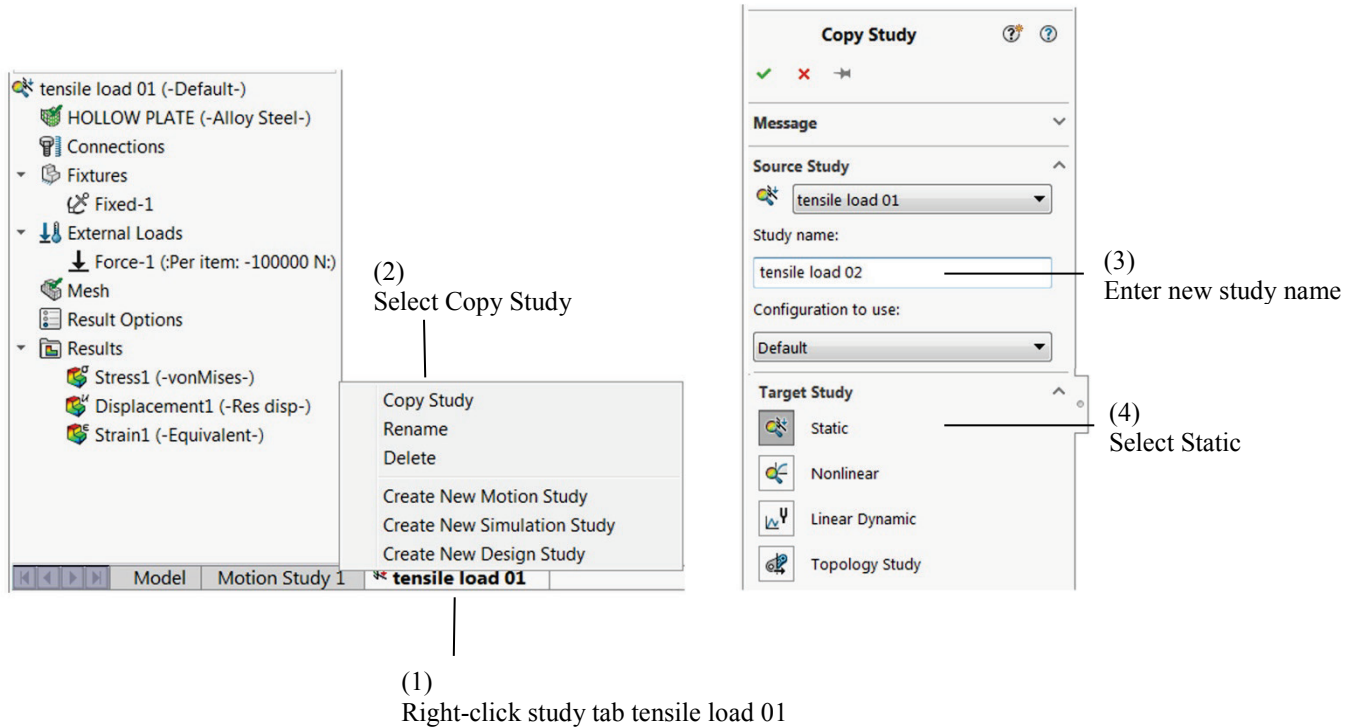

Figure 2-33: A study can be copied into another study in three steps as shown.

*Notice that all definitions in a study (material, restraints, loads, mesh) can also be copied individually from one study to another by dragging and dropping them into a different study tab.*

A study is copied complete with results and plot definitions. Before remeshing with default element size, you must acknowledge the warning message shown in Figure 2-34.

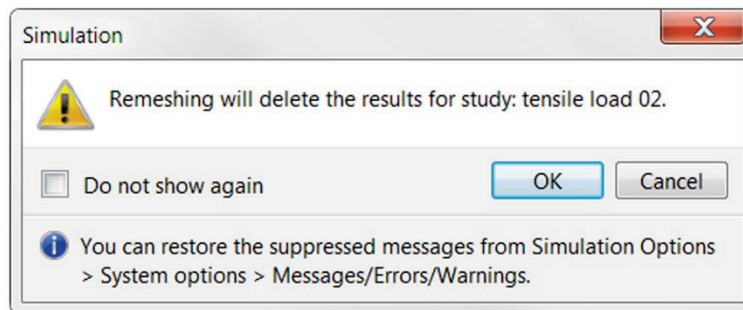

Figure 2-34: Remeshing deletes any existing results in the study.

The summary of results produced by the three studies is shown in Figure 2-35.

Study	Element size [mm]	Number of nodes	Number of elements	Number of DOF	Max. result. displ. [mm]	Max. von Mises stress [MPa]
<i>tensile load 01</i>	11.45	2768	1472	8133	0.117863	339.9
<i>tensile load 02</i>	5.72	12222	7040	36111	0.118068	369.8
<i>tensile load 03</i>	2.86	84112	54969	250851	0.118074	377.1

Figure 2-35: Summary of results produced by the three meshes.

*Notice that these results are based on the same problem. Differences in the results arise from the different mesh densities used in studies tensile load 01, tensile load 02, and tensile load 03.*

*The actual numbers in this table may vary slightly depending on the type of solver and release of the software used for solution.*

Figure 2-36 shows the maximum resultant displacement and the maximum von Mises stress as a function of the number of degrees of freedom. The number of degrees of freedom is in turn a function of mesh density.

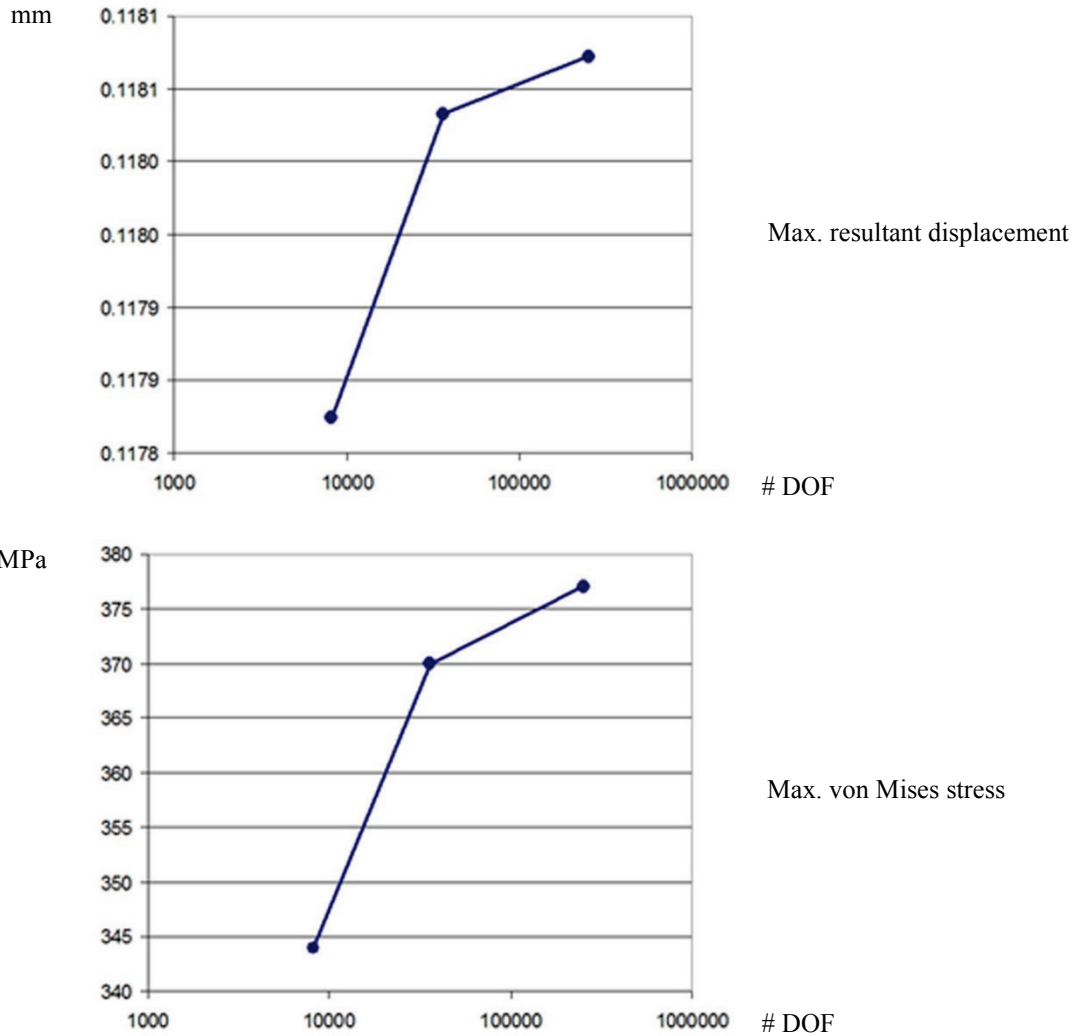

Figure 2-36: Maximum resultant displacement (top) and maximum von Mises stress (bottom).

*Both are plotted as a function of the number of degrees of freedom in the model. The three points on the curves correspond to the three models solved. Straight lines connect the three points only to visually enhance the graphs.*

Having noticed that the maximum displacement increases with mesh refinement, we can conclude that the model becomes “softer” when smaller elements are used. With mesh refinement, a larger number of elements allows for better approximation of the real displacement and stress field. Therefore, we can say that the artificial restraints imposed by element definition become less imposing with mesh refinement.

Displacements are the primary unknowns in structural FEA, and stresses are calculated based on displacement results. Therefore, stresses also increase with



mesh refinement. If we continued with mesh refinement, we would see that both the displacement and stress results converge to a finite value which is the solution of the mathematical model. Differences between the solution of the FEA model and the mathematical model are due to discretization errors, which diminish with mesh refinement.

We will now repeat our analysis of the HOLLOW PLATE by using prescribed displacements in place of a load. Rather than loading it with a 100000N force that caused a 0.118 mm displacement of the loaded face, we will apply a prescribed displacement of 0.118 mm to this face to see what stresses this causes. For this exercise, we will use only one mesh with the default (medium) mesh density.

Define a fourth study, called *prescribed displ.* The easiest way to do this is to copy one of the already completed studies, for example study *tensile load 02*. The definition of material properties, the fixed restraint to the left-side end-face and mesh are all identical to the previous design study. We need to delete the current **External Loads** (right-click the load icon and select **Delete**) and apply in its place a prescribed displacement.

To apply the prescribed displacement to the right-side end-face, right-click the **Fixtures** folder and select **Advanced Fixtures** from the pop-up menu. This opens the **Fixture** definition window. Select **On Flat Face** from the **Advanced** menu and define the displacement as shown in Figure 2-37. Check **Reverse direction** to obtain displacement in the tensile direction. Notice that the direction of a prescribed displacement is indicated by a restraint symbol.

Prescribed displacement may also be defined from the **External Loads** folder by selecting **Prescribed Displacement** from the pop-up menu. This opens the same **Fixture** definition window. Figure 2-37 illustrates both methods of defining prescribed displacement.

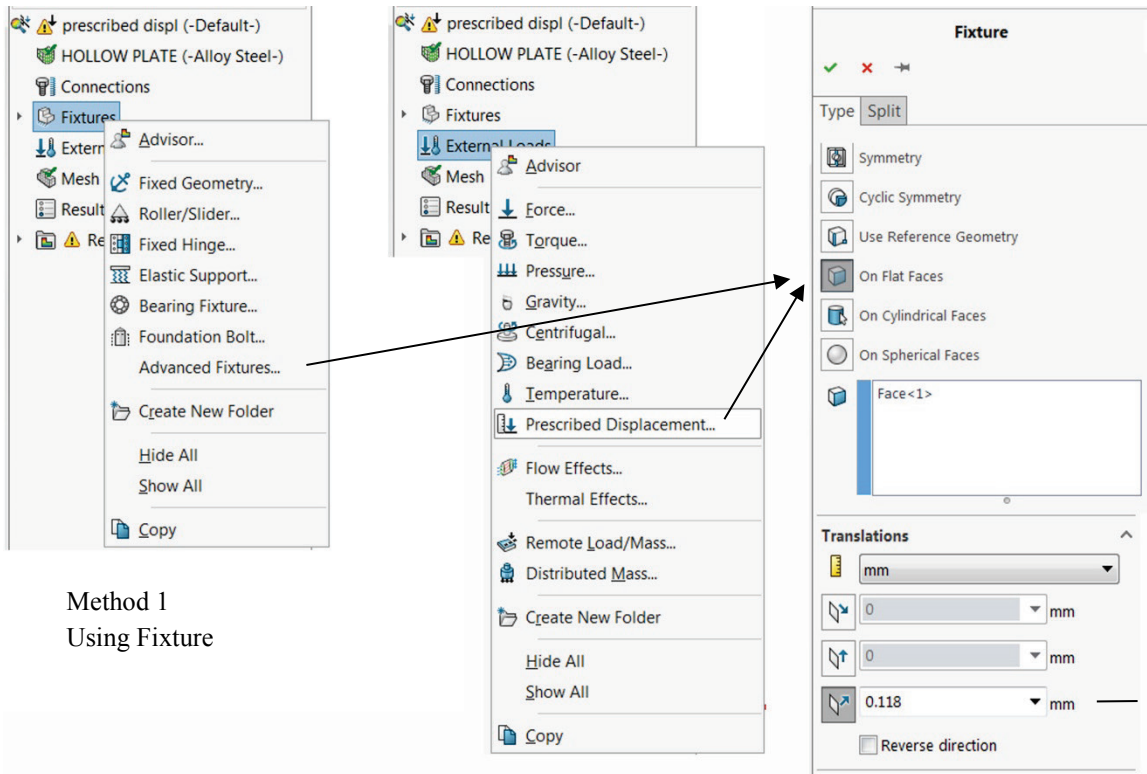

Method 1  
Using Fixture

Method 2  
Using External Loads

Previously defined **Fixed** restraint

Prescribed displacement in the direction normal to face

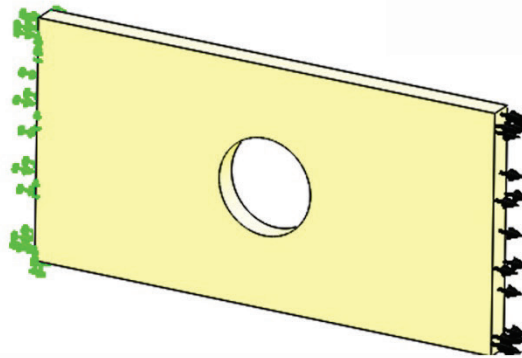

Figure 2-37: Two methods of defining prescribed displacement.

*The prescribed displacement of 0.118 mm is applied to the same face where the tensile load of 100000N was applied in previous studies.*

*Verify that the arrows (shown in black color) are pointed away from the selected face.*

Once again, notice that the visibility of all loads and restraints symbols is controlled by right-clicking the symbol and making the desired choice (**Hide/Show**). All load symbols and all restraint (fixture) symbols may also be turned on/off all at once by right-clicking the **Fixtures** or **External loads** folders and selecting **Hide all/ Show all** from the pop-up menu.

Once a prescribed displacement is defined to the end face, it overrides any previously applied loads to the same end face. While it is better to delete the load in order to keep the model clean, a load has no effect if a prescribed displacement is applied to the same entity in the same direction.

Figure 2-38 compares stress results for the model loaded with force to the model loaded with prescribed displacement.

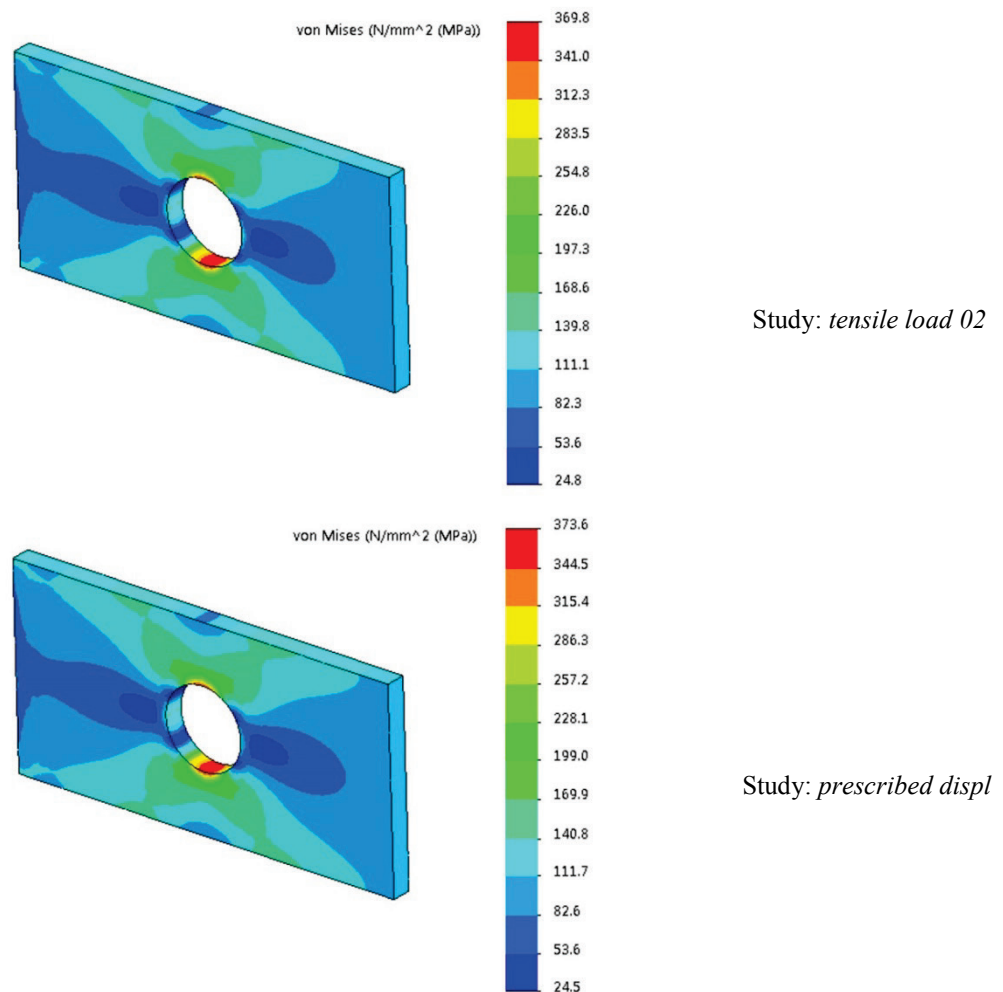

Figure 2-38: Comparison of von Mises stress results.

*Von Mises stress results with a load applied as a force (top) and von Mises stress results with a load applied as a prescribed displacement (bottom).*

Results produced by applying a force load and by applying a prescribed displacement load are very similar but not identical. The reason for this discrepancy is that in the model loaded by force, the loaded face does not remain flat. In the prescribed displacement model, this face remains flat, even though it experiences displacement as a whole. Also, while the prescribed displacement of 0.118 mm applies to the entire face in the prescribed displacement model, it is only seen as a maximum displacement in one point in the force load model. You may plot the displacement along the edge of the end face in study *tensile load 02* by following the steps in Figure 2-39.

(1) Right-click the Displacement plot and select **List selected** to open the **Probe Result** window

(2) Select the edge where you wish to plot displacements. This opens the **Probe Result** window

(3) Click Update

(4) Click Plot

Node	Value (mm)	X (mm)	Y (mm)	Z
232	0.115	0000000	0000000	.00
10875	0.115	0000000	2222137	.00
233	0.115	0000000	4444656	.00
10871	0.116	0000000	6666794	.00
234	0.116	0000000	8888931	.00
10864	0.116	0000000	1111450	.00
235	0.116	0000000	3333588	.00
10858	0.116	0000000	5555534	.00

	Value	
Sum	4.319	mm
Avg	0.117	mm
Max	0.118	mm
Min	0.115	mm
RMS	0.117	mm

Figure 2-39: Plotting displacement along the edge of the force loaded face in study *tensile load 02*.

*Right click the resultant displacement plot in the tensile load 02 study to invoke a pop-up menu shown in the top left corner. Follow steps 1 through 4 to produce a graph of displacements along the loaded edge. Repeat this exercise for a model loaded with a prescribed displacement to verify that the displacement is constant along the edge.*

We conclude the analysis of the HOLLOW PLATE by examining the reaction forces using the results of study *tensile load 02*. In the study *tensile load 02*, right-click the *Results* folder. From the pop-up menu, select **List Result Force** to open the **Result Force** window. Select the face where the fixed restraint is applied and click the **Update** button. Information on reaction forces will be displayed as shown in Figure 2-40.

(1) Right-click the Results folder and select **List Result Force** to open the **Result Force** window

(2) Selected face where Fixed Restraint is applied

(3) Select **Reaction force**

If desired, reference geometry can be selected to define directions of reaction components

(4) Click **Update**

(5) Review reaction forces in the Result Force window and in the model display

If **Display resultant forces** is selected then one resultant force is displayed. Otherwise reaction components are displayed as shown here.

Component	Selection	Entire Model
Sum X:	-1E+005	-1E+005
Sum Y:	0.048229	0.048229
Sum Z:	0.41023	0.41023
Resultant:	1E+005	1E+005

Figure 2-40: Result Force window.

Right-click the Results folder and follow steps 1 through 4 to analyze and display reaction forces. Reaction forces can also be displayed in components other than those defined by the global reference system. To do this, reference geometry such as a plane or axis must be selected.

A note on where **Simulation** results are stored: By default, all study files are saved in the same folder with the **SOLIDWORKS** part or assembly model. Mesh data and results of each study are stored separately in \*.CWR files. For example, the mesh and results of study tensile load 02 have been stored in the file: HOLLOW PLATE-tensile load 02.CWR

When the study is opened, the CWR file is extracted into a number of different files depending on the type of study. Upon exiting **SOLIDWORKS Simulation** (which is done by means of deselecting **SOLIDWORKS Simulation** from the list of add-ins, or by closing the **SOLIDWORKS** model), all files are compressed allowing for convenient backup of **SOLIDWORKS Simulation** results.

The location of CWR files is specified in the **Default Options** window (Figure 2-5). For easy reference, the **Default Options** window is shown again in Figure 2-41.

The size of CWR file may be significantly reduced if stresses and strains are deselected in the Results Options (Figure 2-22). We will work with simple models; therefore, we won't use this option.



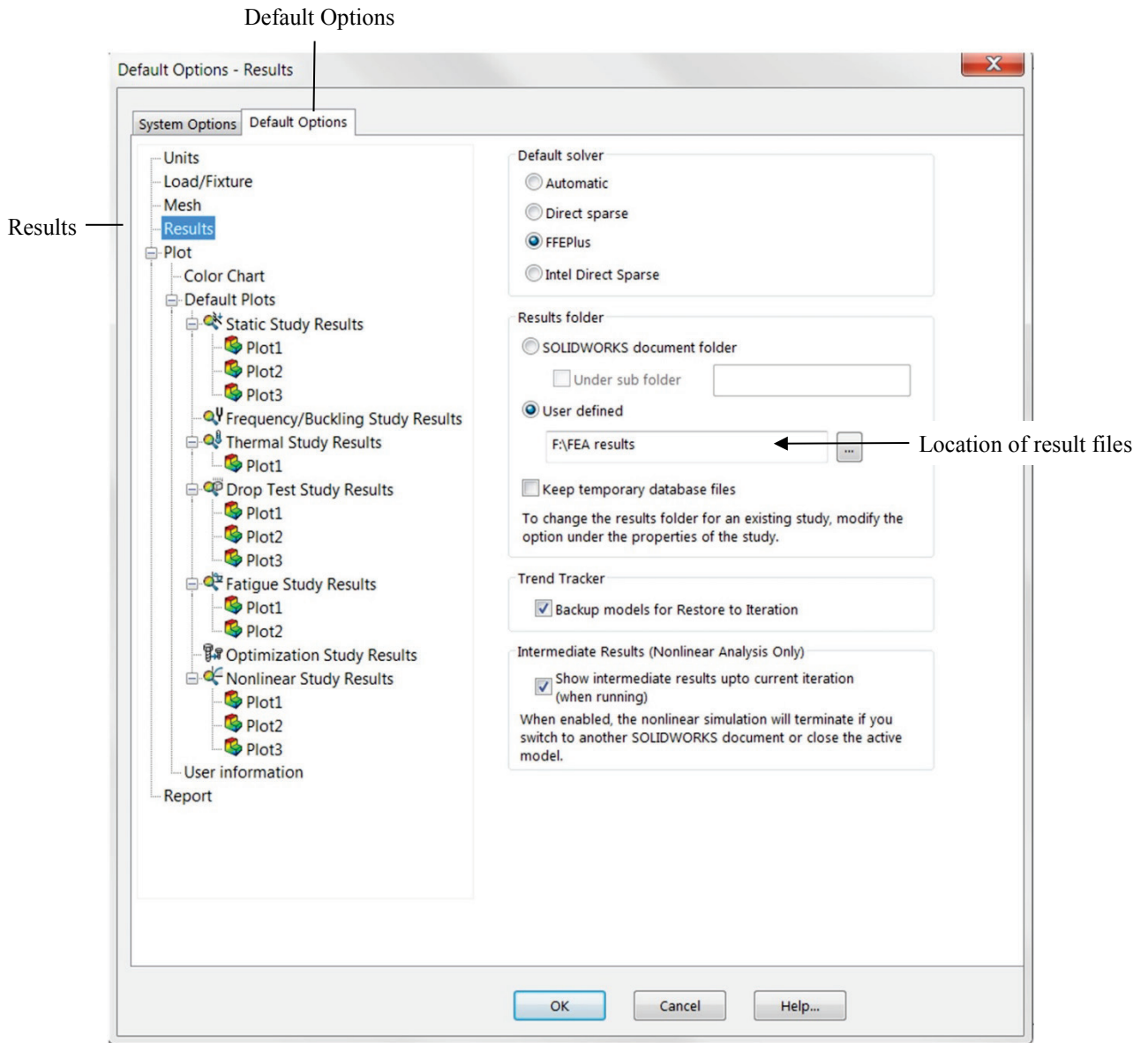

Figure 2-41: Location of solution database files.

*You may use the SOLIDWORKS document folder or a user defined folder as shown above.*

Using the settings shown in Figure 2-41, \*.CWR files are located in folder F:\FEA results. The default location is the SOLIDWORKS document folder.

*Models in this chapter*

<b>Model</b>	<b>Configuration</b>	<b>Study Name</b>	<b>Study Type</b>
HOLLOW PLATE.sldprt	<i>Default</i>	<i>tensile load 01</i>	Static
		<i>tensile load 02</i>	Static
		<i>tensile load 03</i>	Static
		<i>prescribed displ</i>	Static