

# Autodesk® **Revit® 2020 MEP Fundamentals**

Visit the following websites to learn more about this book:

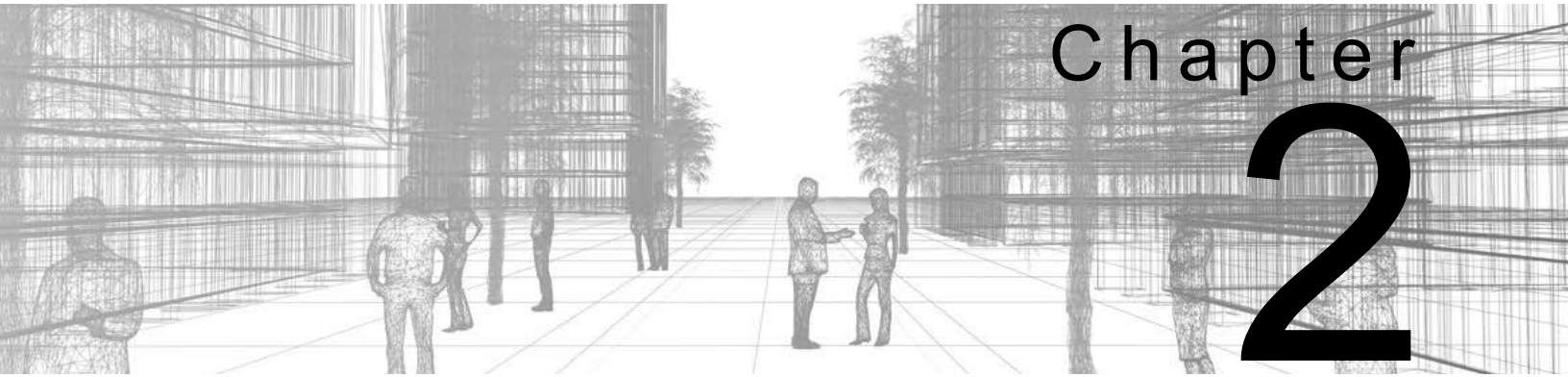



# Chapter 2

## Basic Sketching and Modify Tools

Basic sketching, selecting, and modifying tools are the foundation of working with all types of elements in the Autodesk® Revit® software, including components such as air terminals, plumbing fixtures, and electrical devices. Using these tools with drawing aids helps you to place and modify elements to create accurate building models.

### Learning Objectives in this Chapter

---

- Ease the placement of elements by incorporating drawing aids, such as alignment lines, temporary dimensions, and snaps.
- Place Reference Planes as temporary guide lines.
- Insert components such as mechanical equipment, plumbing fixtures, and electrical devices.
- Use techniques to select and filter groups of elements.
- Modify elements using a contextual tab, Properties, temporary dimensions, and controls.
- Move, copy, rotate, and mirror elements and create array copies in linear and radial patterns.
- Align, trim, and extend elements with the edges of other elements.
- Split linear elements anywhere along their length.
- Offset elements to create duplicates at a specific distance away from the original.

## 2.1 Using General Sketching Tools

When you start a command, the contextual tab on the ribbon, Options Bar, and Properties palette enable you to set up features for each new element you are placing in the project. As you start modeling, several features called *drawing aids* display, as shown in Figure 2–1. They help you to create designs quickly and accurately.

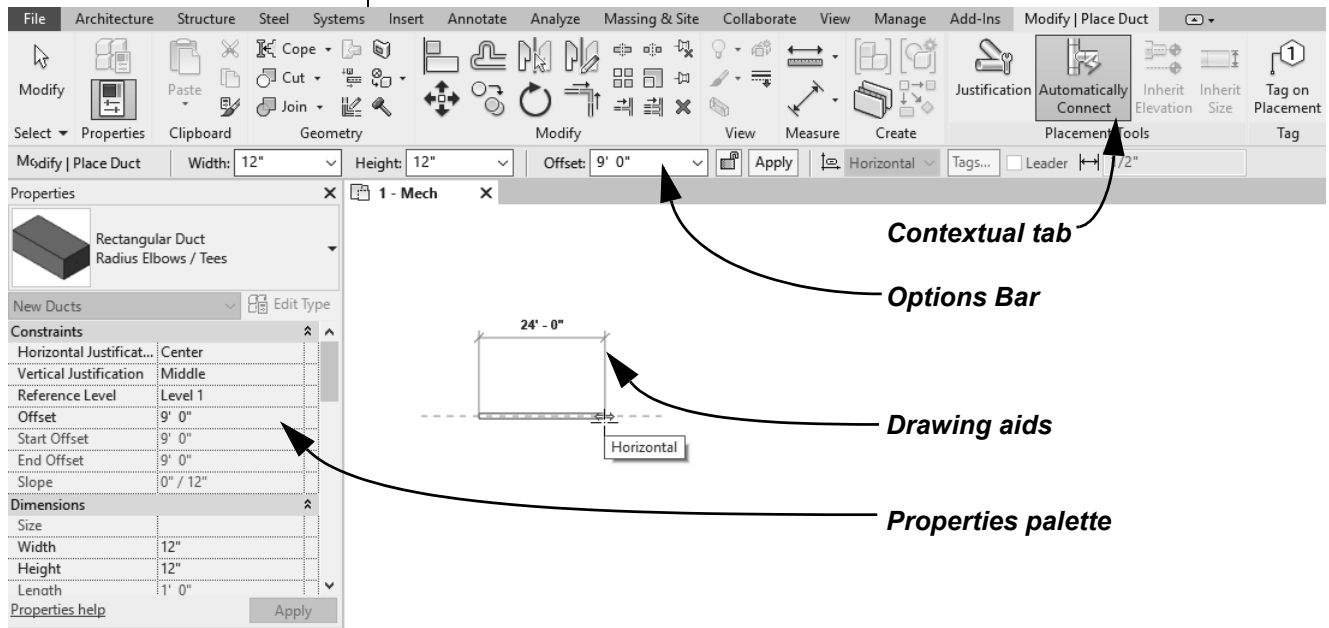

**Figure 2–1**

- When you model ducts, pipes, cable trays, or conduits or place elements such as air terminals, lighting fixtures or plumbing fixtures, you first need to:
  - Select a type from the Type Selector.
  - Set information in the Options Bar.
  - Check the Contextual tab for other options.

### Drawing Aids

As soon as you start sketching or placing elements, several drawing aids display, including:

- Alignment lines
- Temporary dimensions
- Snaps
- Connectors

These aids are available with most drawing and many modification commands, as shown in Figure 2–2.

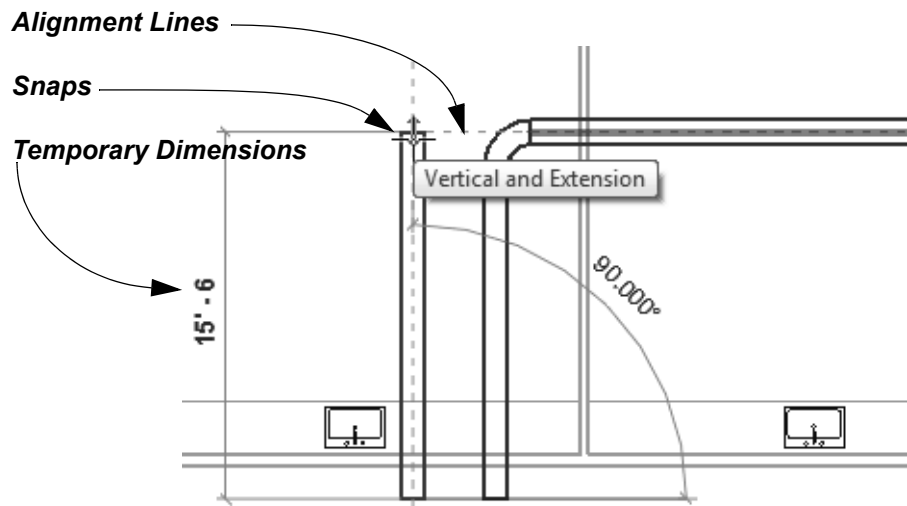

Figure 2–2

**Alignment lines** display as soon as you move the cursor over nearby elements. They help keep lines horizontal, vertical, or at a specified angle. They also line up with the implied intersections of walls and other elements.

- Hold <Shift> to force the alignments to be orthogonal (90 degree angles only).

**Temporary dimensions** display to help place elements at the correct length, angle and location.

- You can type in a value, or move the cursor until you see the dimension you want. Alternatively, you can place the element and then modify the value as required.
- The length and angle increments shown vary depending on how far in or out the view is zoomed.
- For Imperial measurements (feet and inches), the software uses a default of feet. For example, when you type **4** and press <Enter>, it assumes 4'-0". For a distance such as 4'-6", you can type any of the following: **4'-6"**, **4'6**, **4-6**, or **4 6** (the numbers separated by a space). To indicate distances less than one foot, type the inch mark (") after the distance, or enter **0**, a space, and then the distance.

**Hint: Temporary Dimensions and Permanent Dimensions**

Temporary dimensions disappear as soon as you finish adding elements. If you want to make them permanent, select the control shown in Figure 2-3.

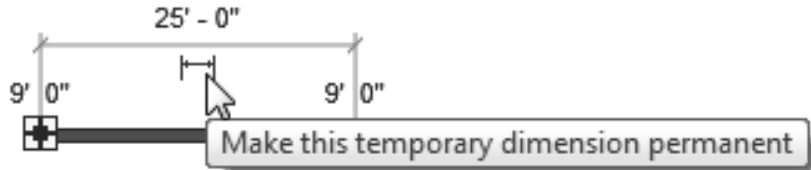

**Figure 2-3**

**Snaps** are key points that help you reference existing elements to exact points when drawing, as shown in Figure 2-4.



**Figure 2-4**

- When you move the cursor over an element, the snap symbol displays. Each snap location type displays with a different symbol

**Connectors** (MEP only) work similar to snaps, but have more intelligence about the size, system, and flow of items (e.g., ducts, pipes, and electrical connections). For example, connectors automatically add fittings to ducts, such as the elbow, transition, and tee shown in Figure 2-5.

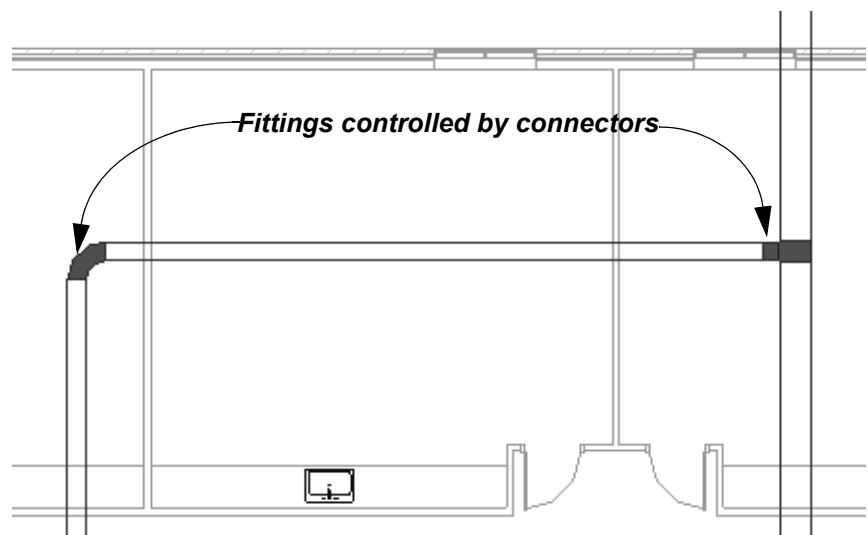

**Figure 2-5**

### Hint: Snap Settings and Overrides

In the *Manage* tab>Settings panel, click  (Snaps) to open the Snaps dialog box, which is shown in Figure 2–6. The Snaps dialog box enables you to set which snap points are active, and set the dimension increments displayed for temporary dimensions (both linear and angular).

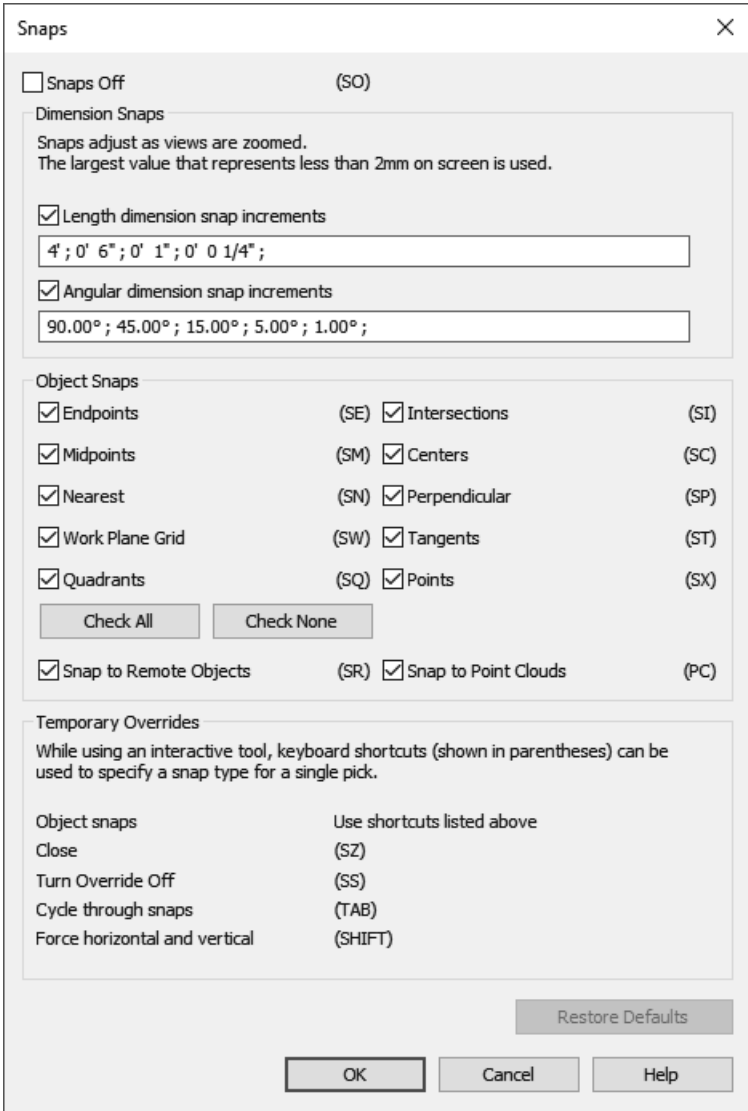



Figure 2–6

- Keyboard shortcuts for each snap can be used to override the automatic snapping. Temporary overrides only affect a single pick, but can be very helpful when there are snaps nearby other than the one you want to use.

## Reference Planes

As you develop designs in the Autodesk Revit software, there are times when you need lines to help you define certain locations. You can draw reference planes (which display as dashed green lines) and snap to them whenever you need to line up elements. For the example shown in Figure 2–7, the lighting fixtures in the reflected ceiling plan are placed using reference planes.

- To insert a reference plane, in the *Architecture*, *Structure*, or *Systems* tab>Work Plane panel, click  (Ref Plane) or type **RP**.

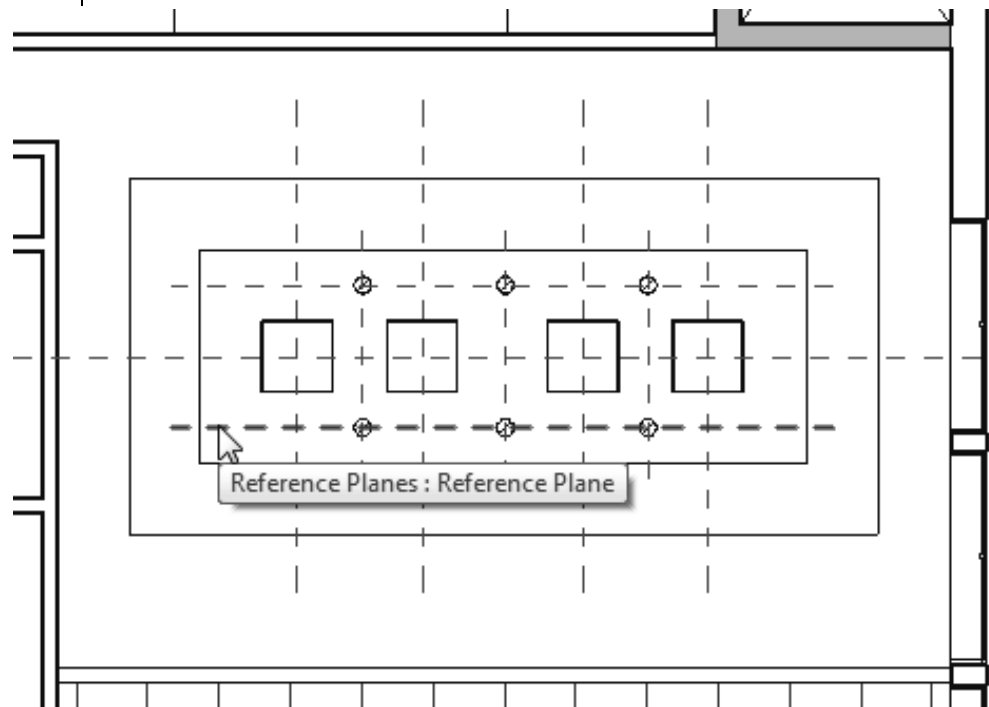

Figure 2–7

- Reference planes display in associated views because they are infinite planes, and not just lines.
- You can name Reference planes by clicking on **<Click to name>** and typing in the text box, as shown in Figure 2–8.



Figure 2–8



- If you sketch a reference plane in Sketch Mode (used with floors and similar elements), it does not display once the sketch is finished.
- Reference planes can have different line styles if they have been defined in the project. In Properties, select a style from the Subcategory list.

### Hint: Measuring Tools

When modifying a model, it is useful to know the distance between elements. This can be done with temporary dimensions, or more frequently, by using the measuring tools found in the Quick Access Toolbar or on the *Modify* tab> Measure panel, as shown in Figure 2–9.

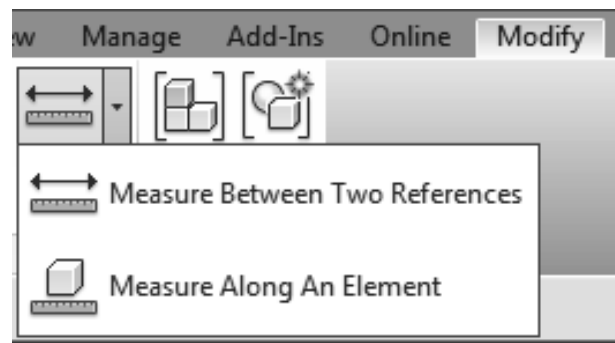



Figure 2–9

-  (Measure Between Two References): Select two elements and the measurement displays.
-  (Measure Along An Element): Select the edge of a linear element and the total length displays.

## 2.2 Inserting Components

Components (also known as families) are full 3D elements that can be placed at appropriate locations and heights, and which interact with the building elements around them. For example, a lighting fixture can be designed to be hosted by a face (such as a wall or ceiling), or to stand alone by itself, as shown in Figure 2–10. The Autodesk Revit software includes both architectural components (such as the lamp and wall sconces in Figure 2–10) and MEP components (such as the downlight fixtures) that include connectors.

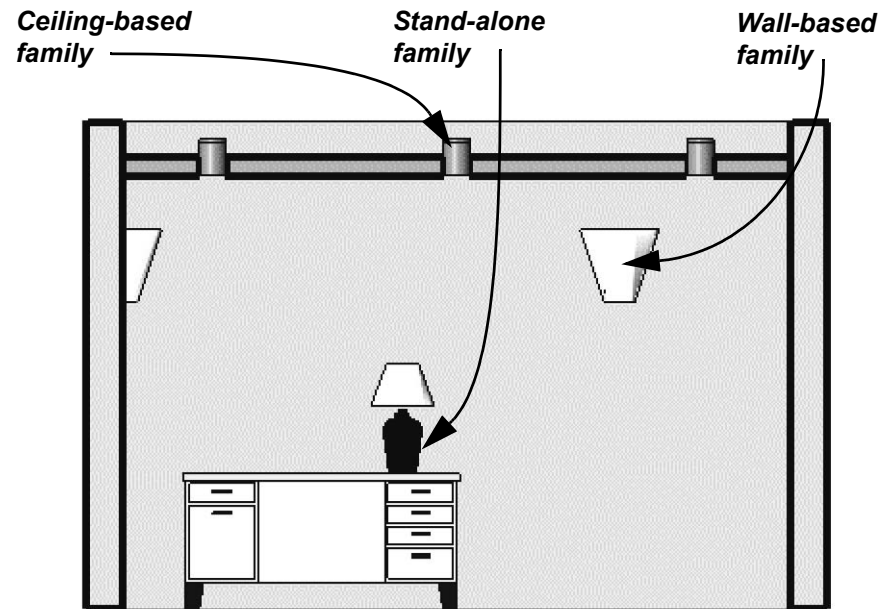











Figure 2–10

Most components are inserted using specific tools, including:

 Air terminal	 Electrical Equipment
 Mechanical Equipment	   Devices (Data, Fire Alarm, Switches, etc.)
 Plumbing Fixture	 Lighting Fixtures
 Sprinkler	

Components are located in family files with the extension .RFA. For example, a component family named **Wall Sconce.rfa** can contain several types and sizes.

Exact steps for inserting specific components are covered later in this guide.

- Take time to get to know the components that come with the Autodesk Revit software. Their most critical content are the connectors, as you see in for a piece of mechanical equipment in Figure 2–11.

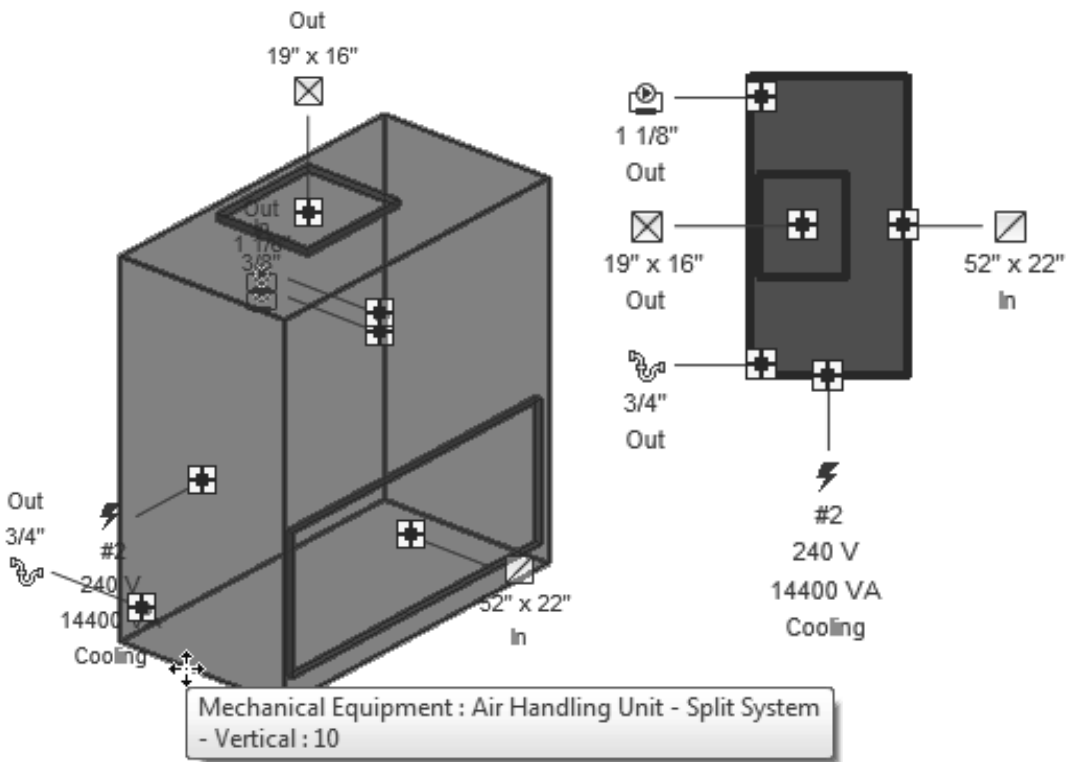

Figure 2–11

- Connectors often contain options to create systems and draw ducts and pipes when you right-click on them.

## How To: Insert Components

1. Start the appropriate command.
2. In the Type Selector, select the type/size you want to use, as shown in Figure 2–12.

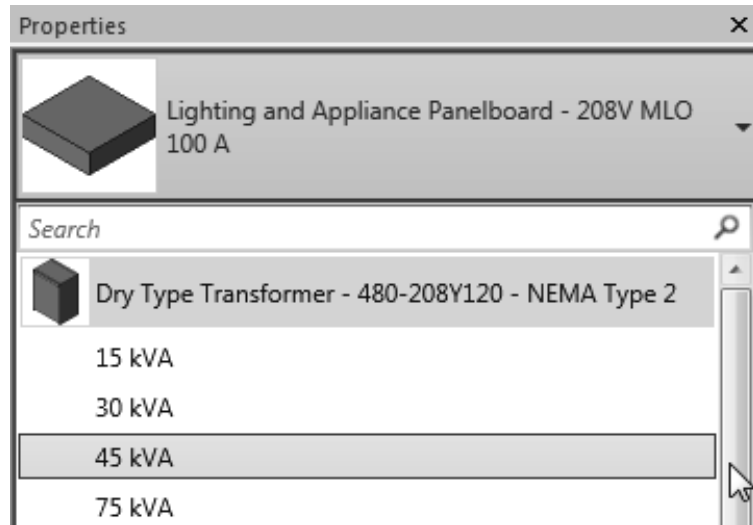



Figure 2–12

3. In the command-specific contextual tab>Tag panel, click  (Tag on Placement) to toggle this option on or off.
4. Proceed as follows, based on the type of component used:

If the component is...	Then...
Not hosted	Set the <i>Level</i> and <i>Offset</i> in Properties, as shown in Figure 2–13.
Wall hosted	Set the <i>Elevation</i> in Properties, as shown in Figure 2–14.
Face hosted	Select the appropriate method in the contextual tab> Placement panel, as shown in Figure 2–15. <ul style="list-style-type: none"> <li>• Vertical Faces include walls and columns.</li> <li>• Faces include ceilings, beams, and roofs.</li> <li>• Work Planes can be set to levels, faces, and named reference planes.</li> </ul>

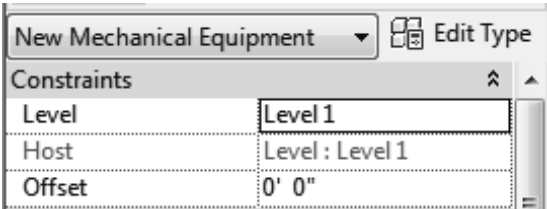

Figure 2-13

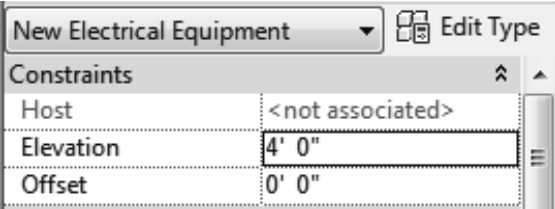

Figure 2-14

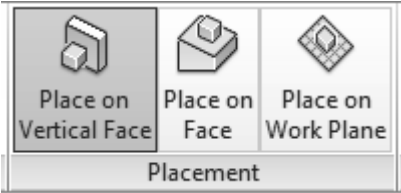

Figure 2-15

- 5. Place the component in the model.
  - A fast way to add components that match those already in your project is to select one, right-click on it, and select **Create Similar**, as shown in Figure 2-16. This starts the appropriate command with the same type selected.

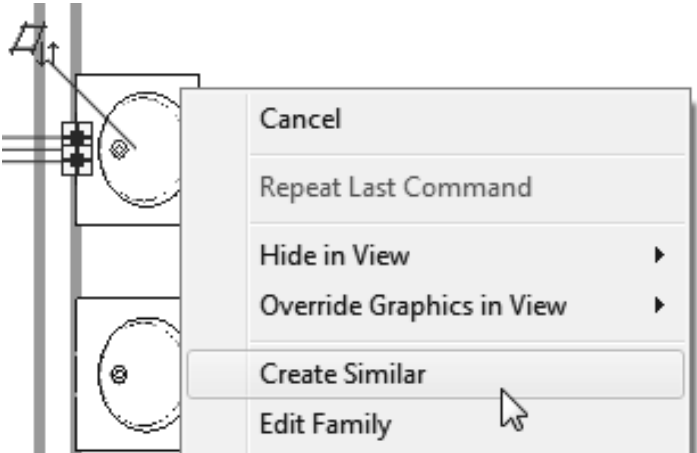



Figure 2-16

**Hint: Work Planes**

A Work Plane is the surface you sketch on or extrude from. In a plan view, the Work Plane is automatically parallel to the level. In an elevation or 3D view, you must specify the Work Plane before you start sketching

**How To: Select a Work Plane**

1. Start a command that requires a work plane or, in the *Architecture* tab>Work Plane panel, click  (Set).
2. In the Work Plane dialog box, select one of the following options:
  - **Name:** Select an existing level, grid, or named reference plane (as shown in Figure 2–17) and then click **OK**.

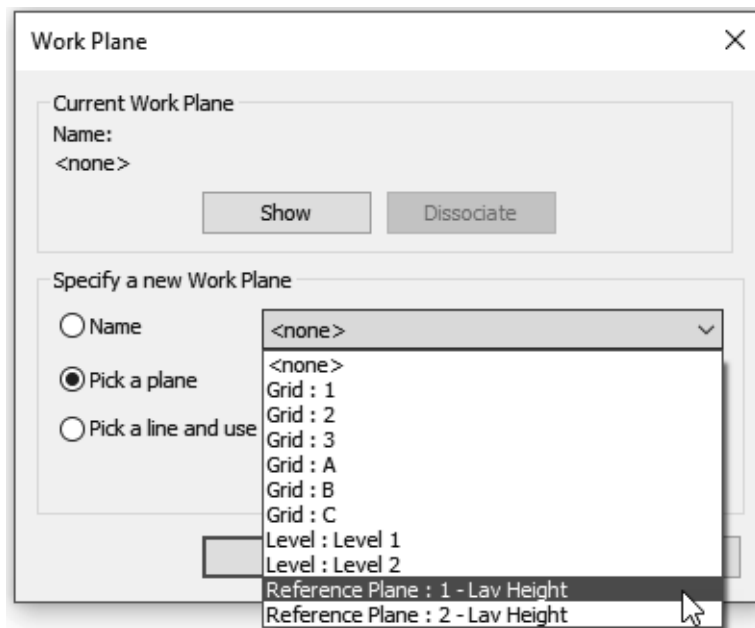
**Figure 2–17**

- **Pick a plane:** Click **OK** and select a plane in the view, such as a wall face. Ensure the entire plane is highlighted before you select it.
- **Pick a line and use the work plane it was sketched in:** Click **OK** and select a model line, such as a room separation line.

If you are in a view in which the sketch cannot be created, the Go To View dialog box opens. Select one of the views and click **Open View**.

## Loading Components

You can load additional families into a project. In the *contextual* tab>Mode panel, click  (Load Family) and then navigate to the appropriate location for your company. The Autodesk Revit library has MEP-based components available in the following folders: *Cable Tray, Conduit, Duct, Electrical, Fire Protection, Lighting, Mechanical, Pipe, and Plumbing*.

### How To: Load a Family

1. In the related contextual tab>Mode panel or *Insert* tab>Load from Library panel, click  (Load Family).
2. In the Load Family dialog box, locate the folder that contains the family or families you want to load, as shown in Figure 2–18.

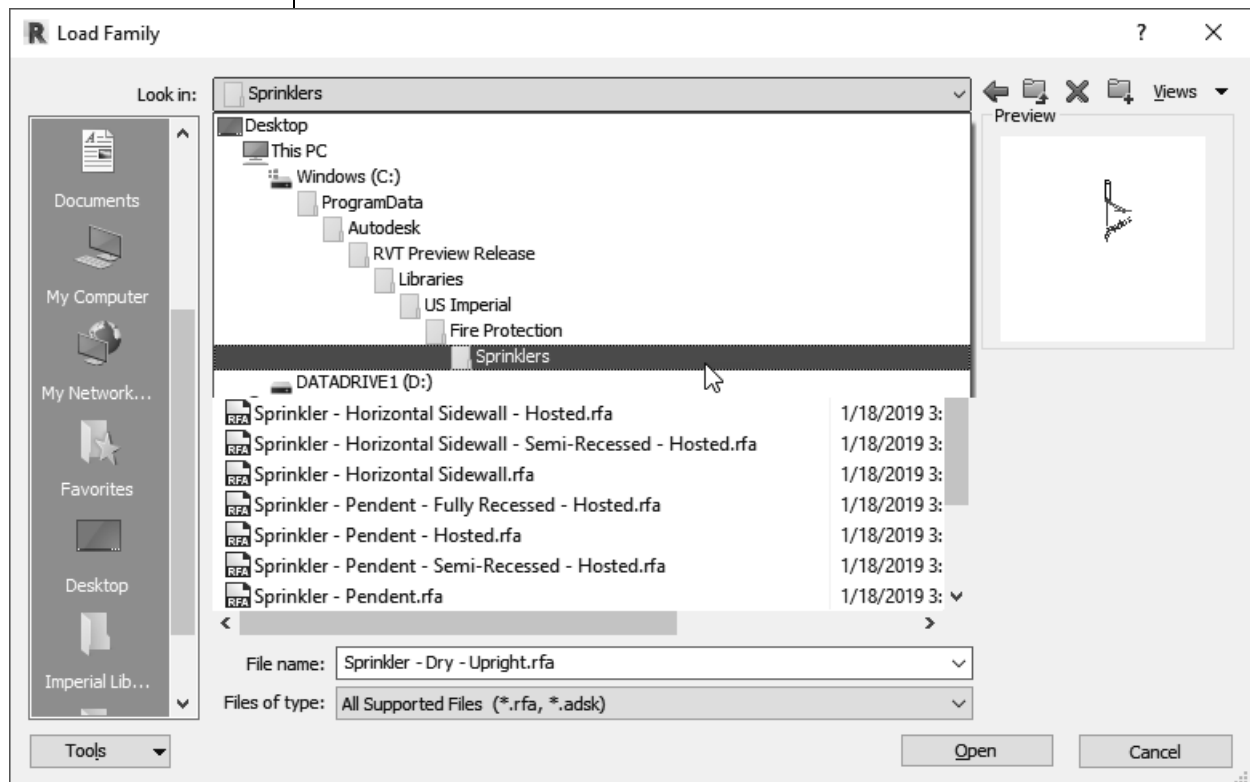
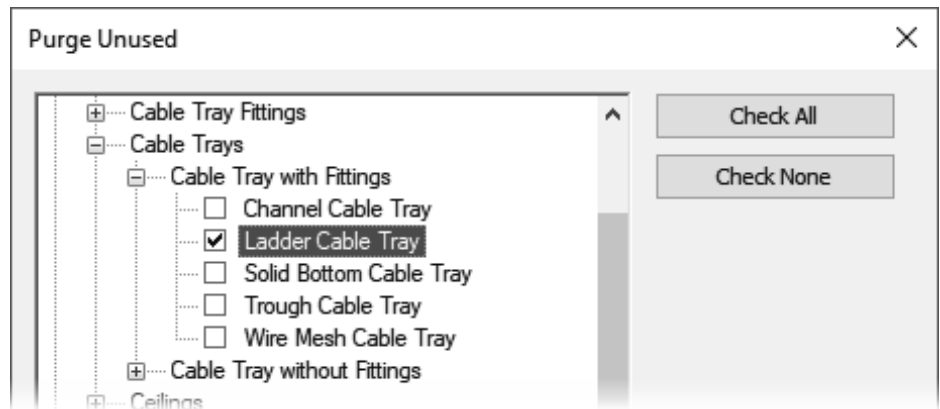

**Figure 2–18**

3. Select the family or families you want to load. You can hold <Ctrl> to select multiple families.
4. Click **Open**.

## Purging Unused Components

You can remove unused elements from a project, including individual component types, as shown in Figure 2–19.



**Figure 2–19**

- Some elements are nested in other elements and it might require several rounds of purging the project to remove them.

### How To: Purge Unused Elements

1. In the *Manage* tab>Settings panel, click  (Purge Unused).
2. In the Purge unused dialog box, click **Check None** and select the elements that you want to purge.
3. Click **OK**.
4. Purging unused components not only helps simplify the component list, but more importantly, reduces the project file size.



## Practice 2a

# Insert Components

### Practice Objectives

- Load and Insert components.
- Use drawing aids.
- Add and name a reference plan.
- Select a work plane.

In this practice, you will insert a variety of MEP fixtures, including air terminals, plumbing fixtures and lighting fixtures, as shown in Figure 2–20. You will use various drawing aids to help you place the fixtures appropriately.

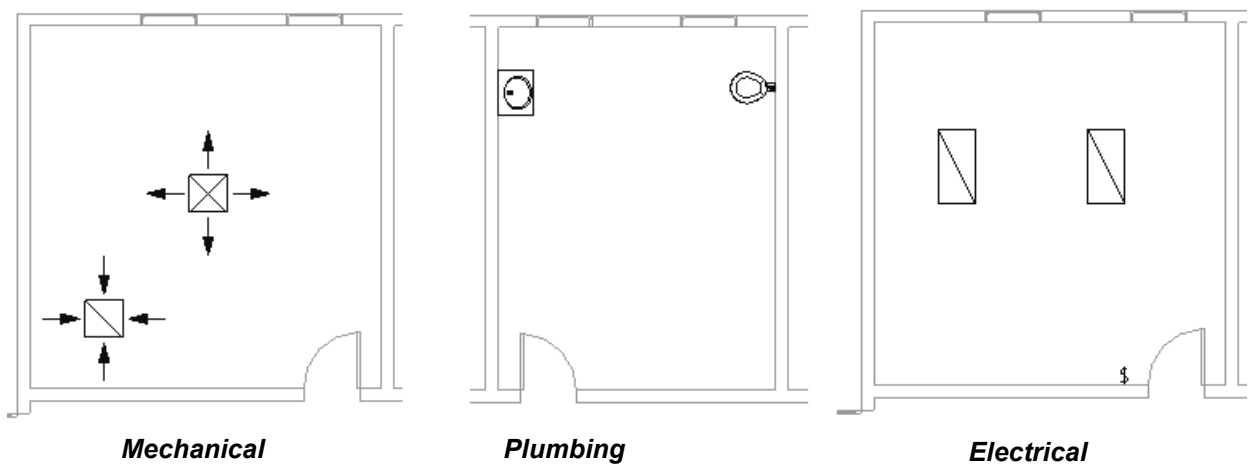

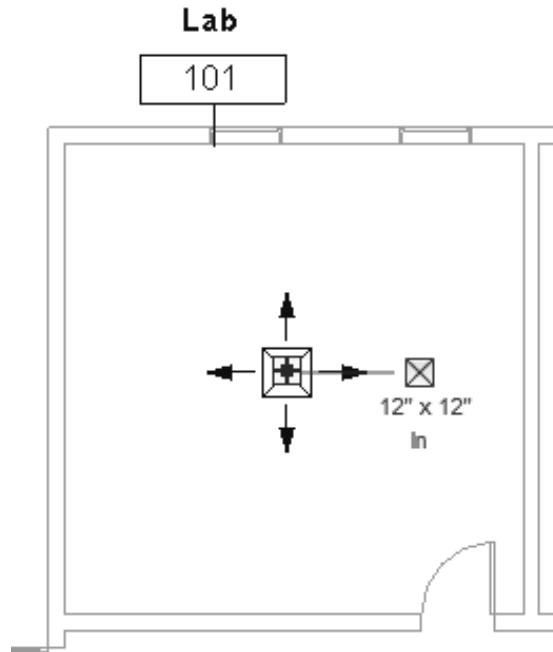

Figure 2–20

### Task 1 - Insert air terminals.

1. In the practice files *Basics* folder, open **Simple-Building-Start.rvt**.
2. In the Project Browser, expand the Mechanical>HVAC>Floor Plans node. The **1 - Mech** view is highlighted, and you are in a Mechanical floor plan.
3. In the *Systems* tab>HVAC panel, click  (Air Terminal).
4. In Properties, note that the default selection is a Supply Diffuser and that the *Level* is **Level 1**. Set the *Offset* to **9'-0"**.

- Click near the center of room **Lab 101**, as shown in Figure 2–21.



**Figure 2–21**

- While still in the Air Terminal command, in the Type Selector, change the *Type* to **Return Diffuser: 24 x 24 Face 12 x 12 Connection** and set the *Offset* to **9'-0"**.
- Click to place the component in the lower left corner of room **Lab 101**.
- In the *Systems* tab>Mechanical panel, click  (Mechanical Equipment.)
- In the Type Selector, select **Boiler: Standard**.
- In the **Mech/Elec Room**, move the cursor near the outside wall. Note that the boiler automatically aligns to the wall, as shown in Figure 2–22.

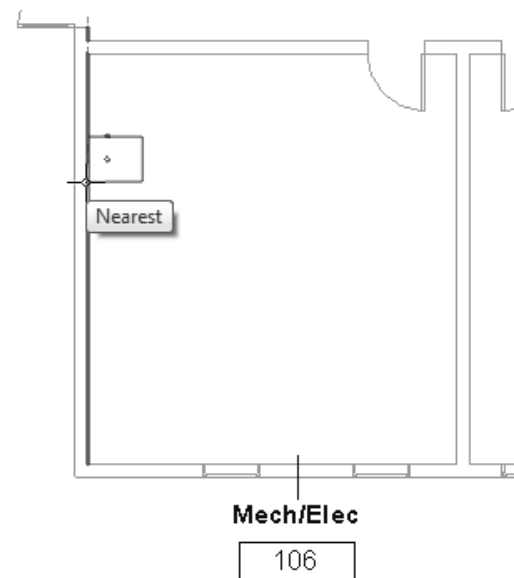

Figure 2-22

11. Click to place the component.
12. Save the project.

---

### Task 2 - Load and place plumbing fixtures.

---

*The air terminals are automatically toggled off because you are in a plumbing view, but the boiler still displays because Mechanical Equipment is typically toggled on.*

1. In the Project Browser, expand the Plumbing>Plumbing>Floor Plans node and double-click to open the **1 - Plumbing** view.
2. In the *Systems* tab>Plumbing & Piping panel, click  (Plumbing Fixture).
3. In the Type Selector, select one of the wall-mounted water closets.
4. Click along one of the walls to place the fixture, as shown in Figure 2-23.

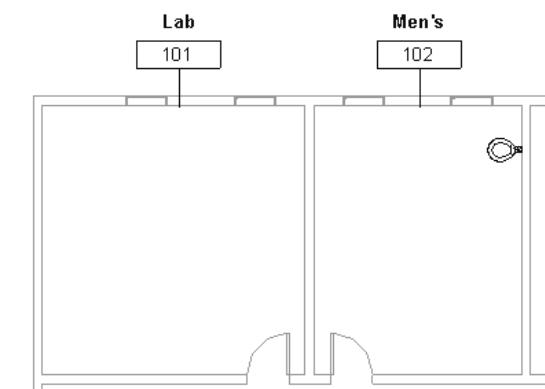



Figure 2-23

5. Return to the Type Selector and review the list. Note that there are sinks, but no lavatories.
6. In the *Modify | Place Plumbing Fixture* tab>Mode panel, click  (Load Family).
7. In the Load Family dialog box, the Autodesk Revit family library automatically displays. Navigate to the *Plumbing>MEP>Fixtures>Lavatories* folder and select **Lavatory - Oval.rfa**, as shown in Figure 2–24.

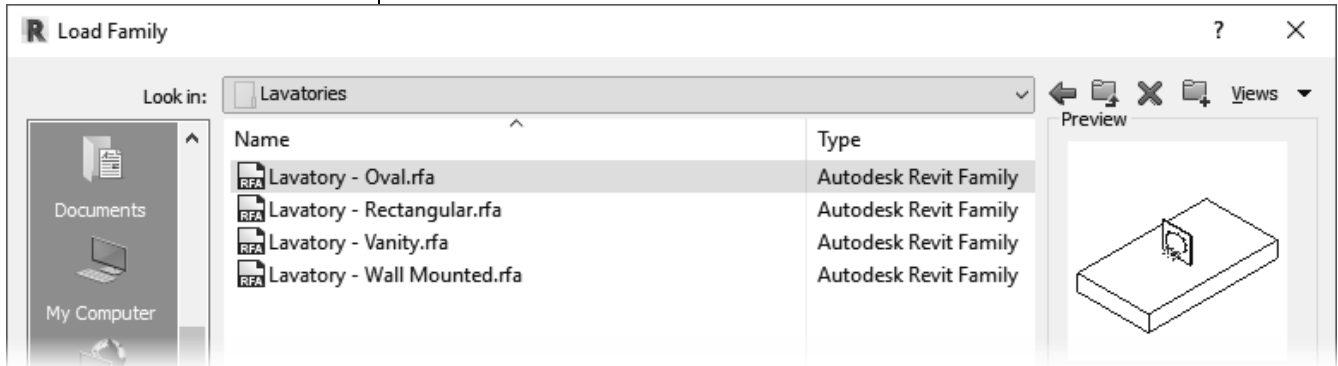



Figure 2–24

8. Click **Open**.
9. In the Type Selector, select **Lavatory - Oval: 25"x20" - Public**.
10. Place the lavatory against the wall across from the water closet.
11. Click  (Modify) and select the new fixture. Drag it up or down until it meets with the alignment line of the WC, as shown in Figure 2–25.

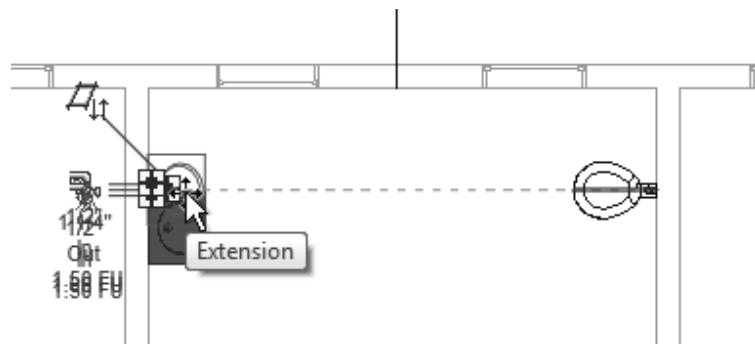



Figure 2–25

12. Click outside the building model to release the selection.
13. Save the project.

### Task 3 - Place a lighting fixture and switch.

1. In the Project Browser, expand the Electrical>Lighting> Ceiling Plans node and double-click on **1 - Ceiling Elec** view to open it.
  - Ensure that you are opening the Ceiling Plan so that the ceiling grids display.
  - None of the previous elements that you have added display.
2. In the *Systems* tab>Electrical panel, click  (Lighting Fixture).
3. In the Type Selector, select **Plain recessed Lighting Fixture: 2x4 - 277**.
4. In the *Modify | Place Fixture* tab>Placement panel, click  (Place on Face).
5. Move the cursor over the grid. The light snaps to the grid lines, as shown in Figure 2–26.
6. Press <Spacebar> to rotate the fixture. Click to place two fixtures in the room, as shown in Figure 2–27.

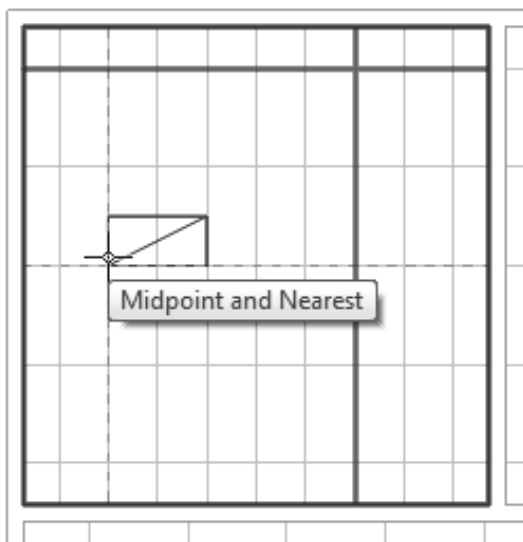

Figure 2–26

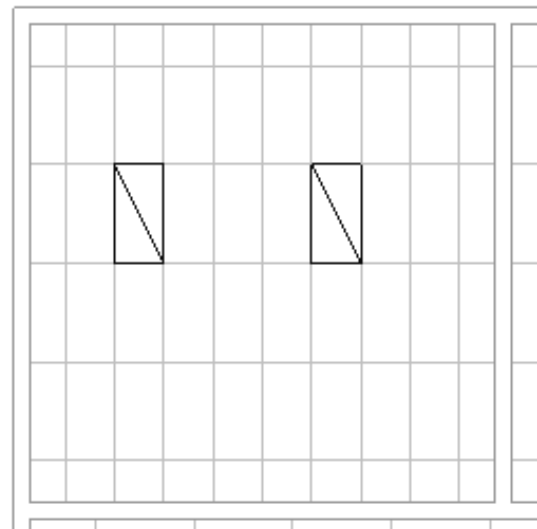

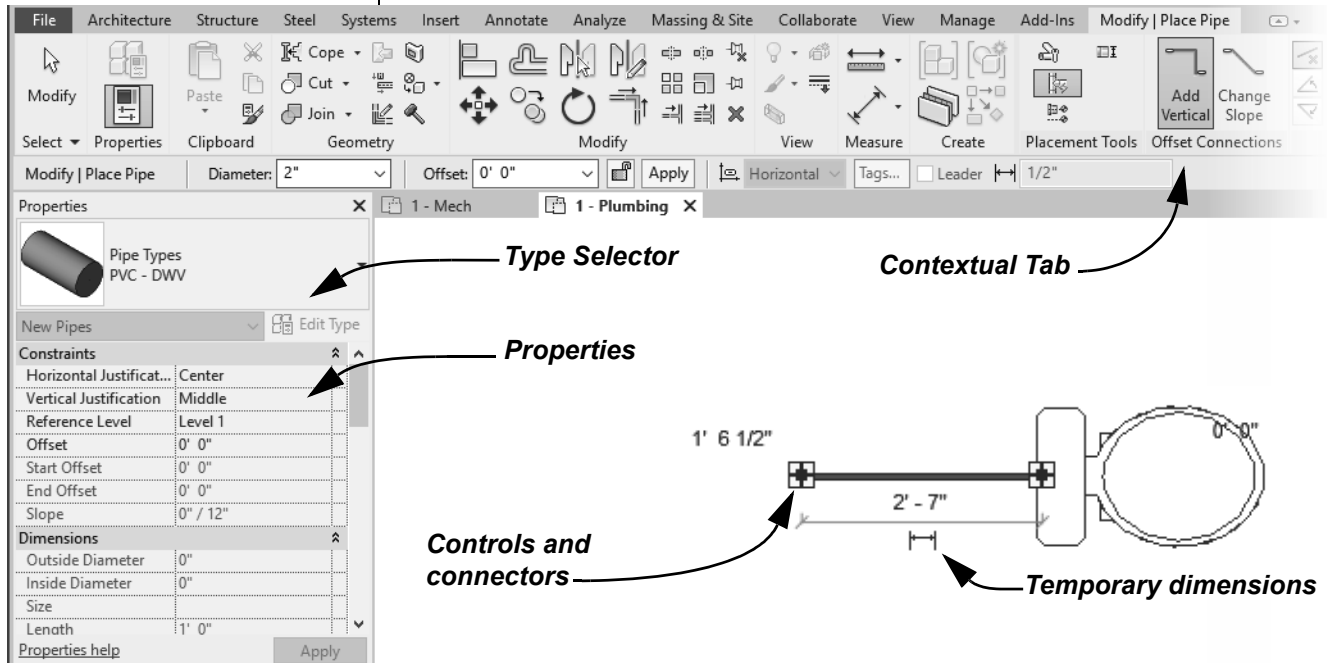

Figure 2–27

7. Open the Electrical>Lighting>Floor Plans>**1 - Lighting** view. The light fixtures display in this view although you are seeing a plan view.
8. In the *Systems* tab>Electrical panel, expand the Device drop-down list and select  (Lighting).
9. In the Type Selector, select **Lighting Switches: Single Pole**.
10. In Properties, note that the *Elevation* is set to **4'-0"**, a standard height for switches.
11. Place the switch to the left of the door. It displays only as a symbol.
12. Click  (Modify) to end the command.
13. Save the project.

## 2.3 Selecting and Editing Elements

Building design projects typically involve extensive changes to the model. The Autodesk Revit software was designed to make such changes quickly and efficiently. You can change an element using the methods shown in Figure 2–28, and described below:



**Figure 2–28**

- Type Selector enables you to specify a different type. This is frequently used to change the size and/or style of the elements.
- Properties enables you to modify the information (parameters) associated with the selected elements.
- Temporary dimensions enable you to change the element's dimensions or position.
- The contextual tab in the ribbon contains the Modify commands and element-specific tools.
- Controls enable you to drag, flip, lock, and rotate the element.

- Connectors control how related elements attach to another with intelligence about size, needed fittings, and system information. (MEP only)
- Shape handles (not shown) enable you to drag elements to modify their height or length.
- To delete an element, select it and press <Delete>, right-click and select **Delete**, or in the Modify panel, click  (Delete).

## Working with Controls and Connectors

When you select an element, various controls and connectors display depending on the element and view. Using controls, you can change an element's length or location, and flip or rotate some elements. MEP connectors also provide information about attachments and enable you to add related elements, as shown for creating pipe from a pipe accessory in Figure 2–29.

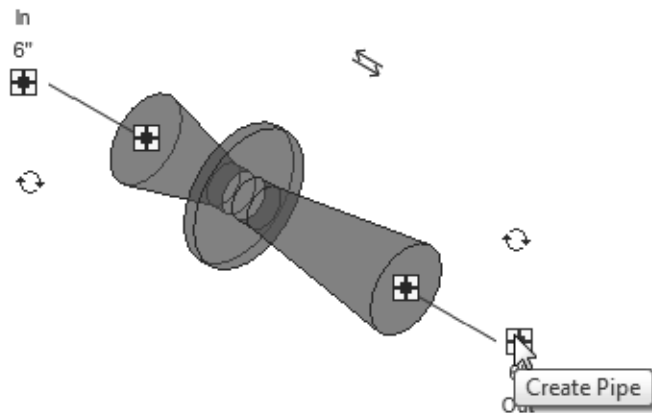

**Figure 2–29**

- If you hover the cursor over the control or connector, a tooltip displays showing its function.



**Hint: Editing Temporary Dimensions**

Temporary dimensions automatically link to the closest wall. To change the location, you can drag the *Witness Line* control (as shown in Figure 2–30) to connect to a new reference. You can also click on the control to toggle between justifications in the wall.

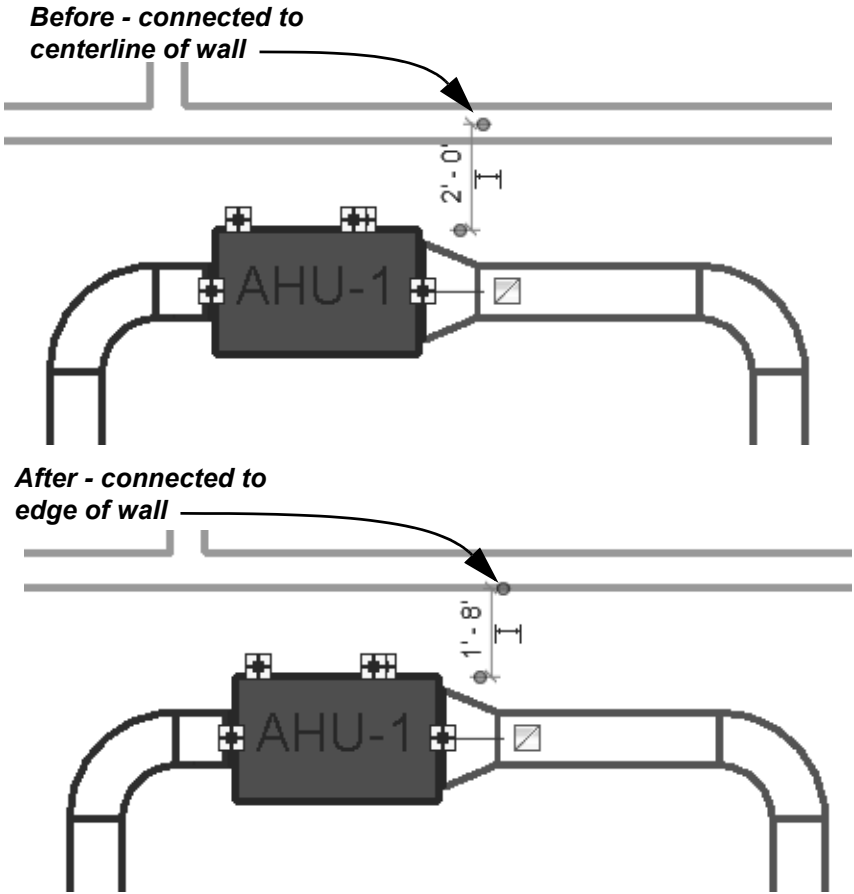

**Figure 2–30**

- The new location of a temporary dimension for an element is remembered as long as you are in the same session of the software.

## Selecting Multiple Elements

- Once you have selected at least one element, hold <Ctrl> and select another item to add it to a selection set.
- To remove an element from a selection set, hold <Shift> and select the element.
- If you click and drag the cursor to *window* around elements, you have two selection options, as shown in Figure 2–31. If you drag from left to right, you only select the elements completely inside the window. If you drag from right to left, you select elements both inside and crossing the window.

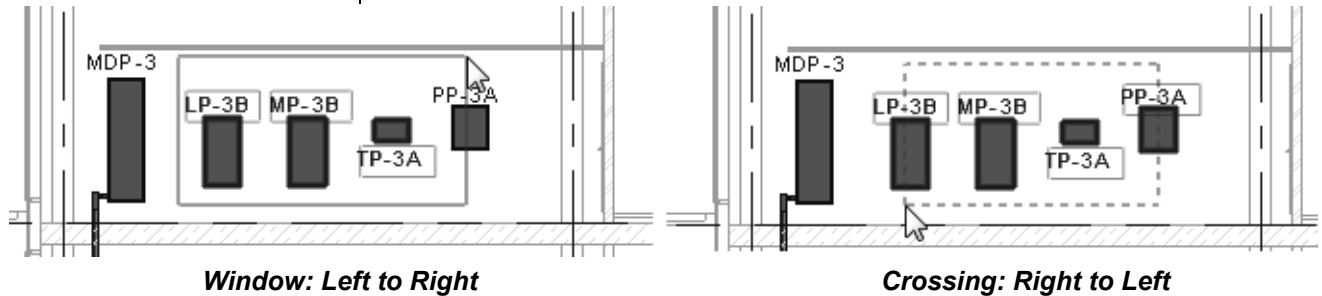

Figure 2–31

- If several elements are on or near each other, press <Tab> to cycle through them before you click. If there are elements that might be linked to each other, such as ductwork, pressing <Tab> selects the chain of elements.
- Press <Ctrl>+<Left Arrow> to reselect the previous selection set. You can also right-click in the drawing window with nothing selected and select **Select Previous**.
- To select all elements of a specific type, right-click on an element and select **Select All Instances>Visible in View** or **In Entire Project**, as shown in Figure 2–32. For example, if you select an air terminal of a specific size and use this command, all air terminals of the same size would be selected, excluding all of the air terminals of other sizes.

*You do not have to select an element; just hover over the one you want to select.*

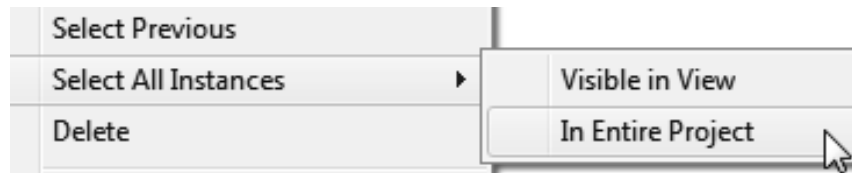







Figure 2–32

**Hint: Selection Options**

You can control how the software selects specific elements in a project by toggling Selection Options on and off on the Status Bar, as shown in Figure 2–33. Alternatively, in any tab on the ribbon, expand the Select panel's title and select the option.



**Figure 2–33**

-  **Select links:** When toggled on, you can selected linked drawings or Autodesk Revit models. When it is toggled off you cannot select them when using **Modify** or **Move**.
-  **Select underlay elements:** When toggled on, you can select underlay elements. When toggled off, you cannot select them when using **Modify** or **Move**.
-  **Select pinned elements:** When toggled on, you can selected pinned elements. When toggled off, you cannot select them when using **Modify** or **Move**.
-  **Select elements by face:** When toggled on you can select elements (such as the floors or walls in an elevation) by selecting the interior face or selecting an edge. When toggled off, you can only select elements by selecting an edge.
-  **Drag elements on selection:** When toggled on, you can hover over an element, select it, and drag it to a new location. When toggled off, the Crossing or Box select mode starts when you press and drag, even if you are on top of an element. Once elements have been selected they can still be dragged to a new location.

## Filtering Selection Sets

When multiple element categories are selected, the *Multi-Select* contextual tab opens in the ribbon. This gives you access to all of the Modify tools, and the **Filter** command. The **Filter** command enables you to specify the types of elements to select. For example, you might only want to select lighting fixtures, as shown in Figure 2–34.

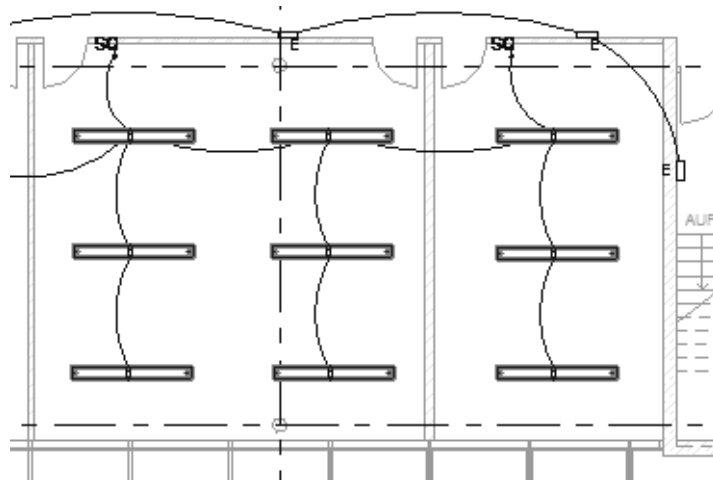



Figure 2–34

### How To: Filter a Selection Set

1. Select everything in the required area.
2. in the *Modify | Multi-Select* tab>Selection panel, or in the

Status Bar, click  (Filter). The Filter dialog box opens, as shown in Figure 2–35.

*The Filter dialog box displays all types of elements in the original selection.*

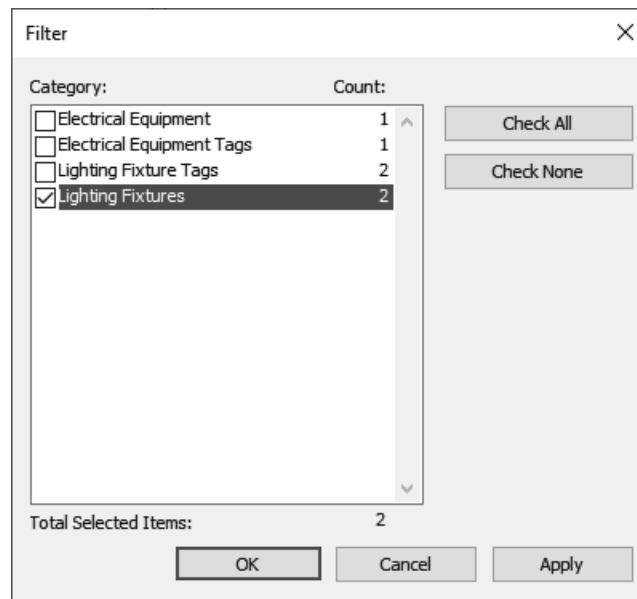

Figure 2–35

3. Click **Check None** to clear all of the options or **Check All** to select all of the options. You can also select or clear individual categories as required.
  4. Click **OK**. The selection set is now limited to the elements you specified.
- In the Status Bar, the number of elements selected displays beside the Filter icon, as shown in Figure 2–36. You can also see the number of selected elements in the Properties palette.



**Figure 2–36**

- Clicking the Filter icon in the Status Bar also opens the Filter dialog box.

## Practice 2b

## Select and Edit Elements

### Practice Objectives

- Use a variety of selection methods.
- Use temporary dimensions and connectors to modify the location of elements.

In this practice, you will select lighting fixtures and change the type (as shown in Figure 2–37), as well as test a variety of selection methods and filters. You will then use connectors to modify the location of an air terminal and use **Create Similar** to add additional components. You will also modify the height of the air terminals in Properties.

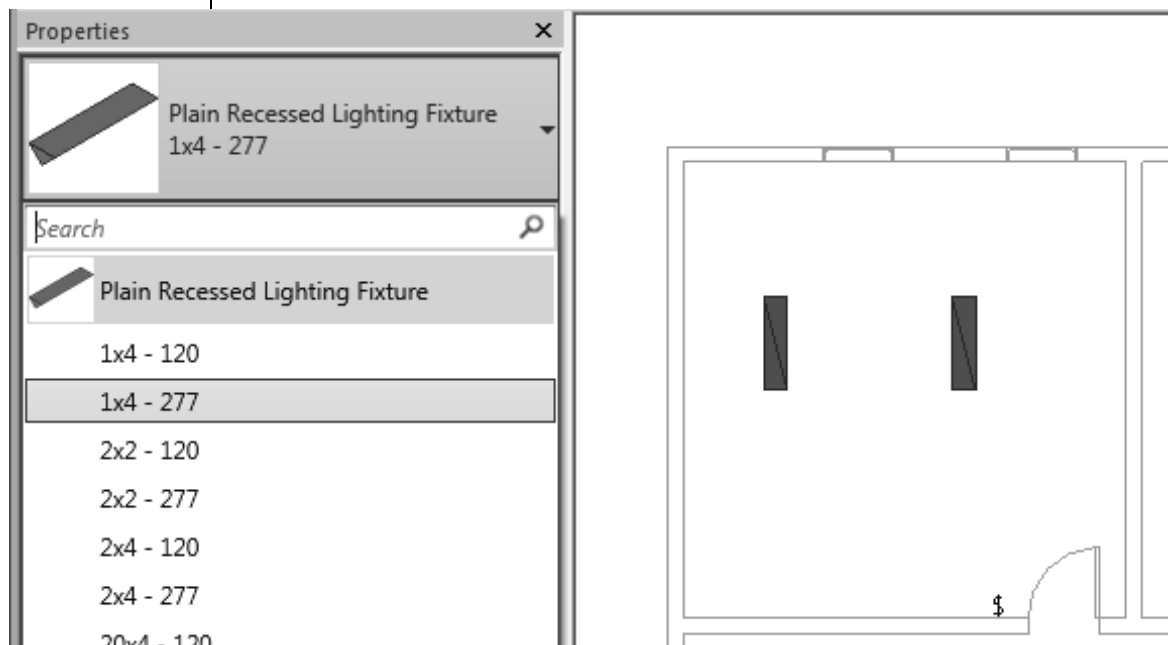
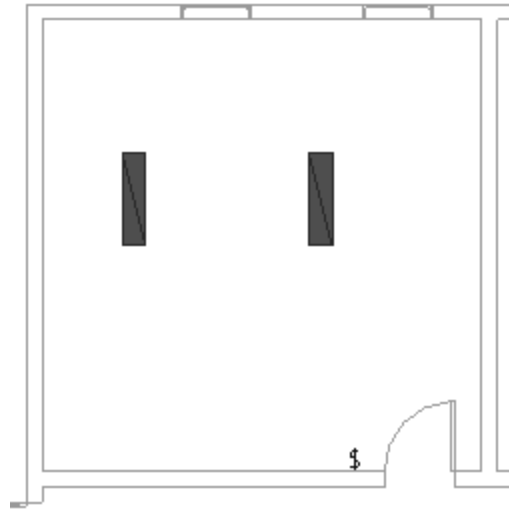

Figure 2–37

### Task 1 - Use a variety of selection methods.

1. In the practice files *Basics* folder, open **Simple-Building-Edit.rvt**. It opens in the **1 - Lighting** view.
2. Select one of the light fixtures. The connectors and controls are displayed.
3. Hold <Ctrl> and select the other fixture. The connectors no longer display, but you can still modify the fixture type.

4. In the Type Selector, change the type to **Plain Recessed Lighting Fixture: 1x4 - 277**. Both fixtures change, as shown in Figure 2–38.



**Figure 2–38**

5. Click away from any elements to clear the selection.
6. Open the Mechanical>HVAC>Floor Plans>**1 - Mech** view.
7. Draw a window from left to right around some of the elements so only those completely inside the window are selected, as shown in Figure 2–39.

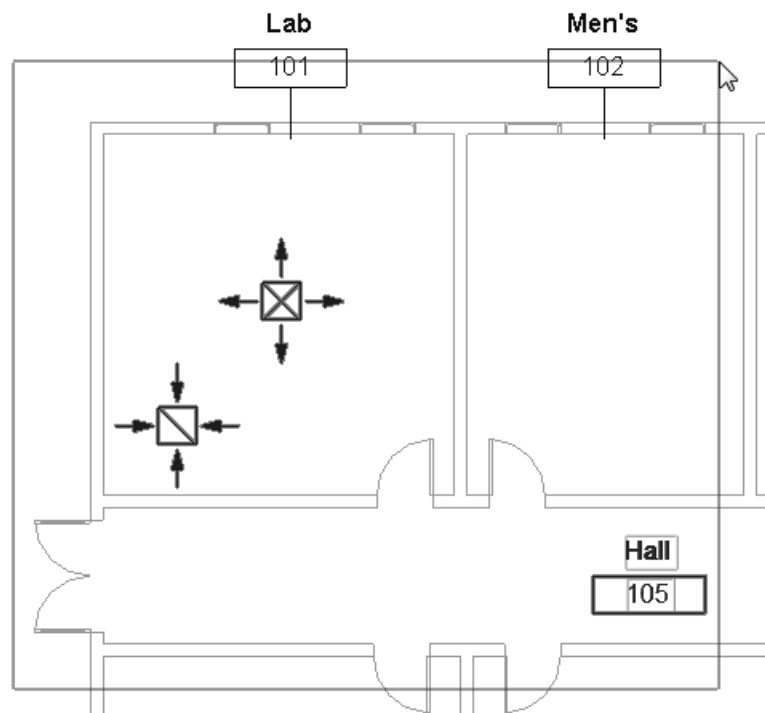

**Figure 2–39**

You can toggle



(Select Links) in the Status Bar to keep the link from being selected.

8. Click to clear the selection.
9. Draw a crossing window (i.e., from right to left) around the same area, as shown in Figure 2–40. Note that any elements that the window touches are included in the selection, including the linked architectural model.

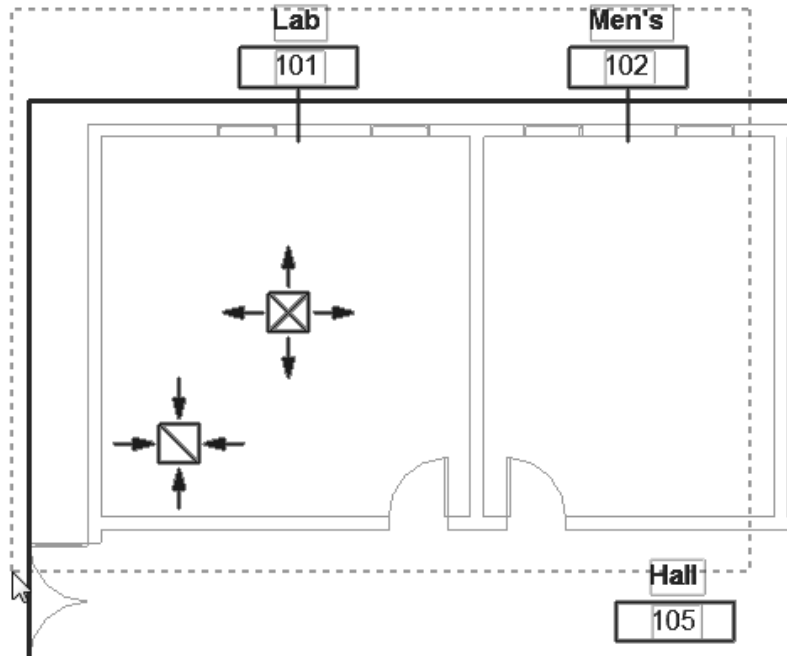



Figure 2–40

10. Hold <Shift> and select the edge of the architectural model. This removes the element from the selection set.
11. In the Status Bar, note the number of items that are selected and click  (Filter).
12. In the Filter dialog box, view the categories and clear the check from **Air Terminals**.
13. Click **OK**. Only the room tags are still selected.
14. Press <Esc>. The elements are no longer selected.
15. Select one of the room tags. Right-click and select **Select All Instances>Visible in View**. All of the tags are selected.
16. Click  (Modify). The elements are no longer selected.
  - Remember these selection methods as you start working in the projects.



## Task 2 - Modify elements using controls and properties.

1. Continue working in the **1 - Mech** view.
2. Select, click and drag the supply air terminal to a new location using the alignment lines referencing the return air terminal.
3. Right-click on the control and look at the variety of options you can use, as shown in Figure 2–41.

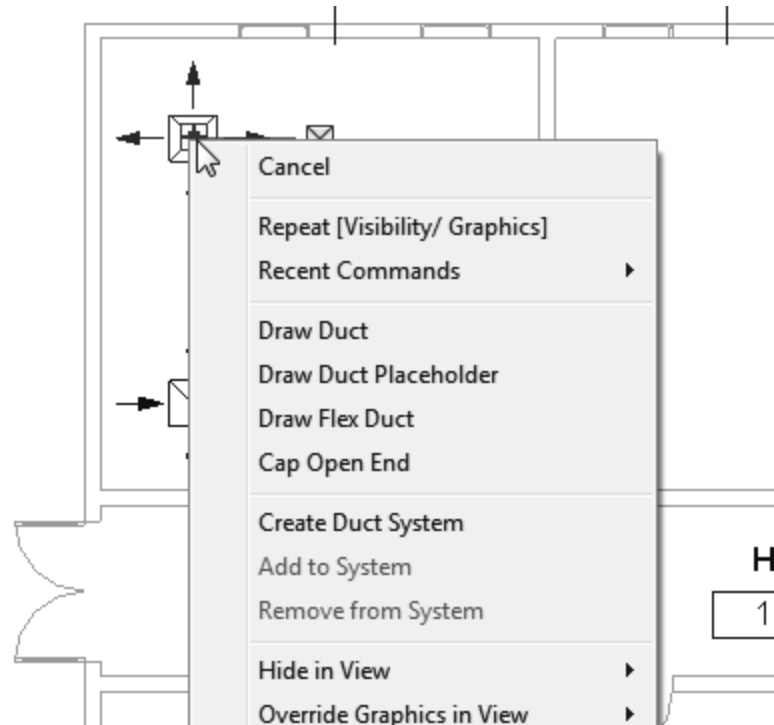



Figure 2–41

4. In the shortcut menu, select **Create Similar**. This starts the **Air Terminal** command using that type. Place two more air terminals in the same room, using alignment lines to place them.
5. Click  (Modify) and select all three of the supply air terminals. Note the information in Properties. The *Offset* is set to **0'-0"** above **Level 1**.
6. Hold <Ctrl> and select the return air terminal. The *Level* and *Offset* are available to change, although two different types of components are selected.

7. Change the *Offset* to **8'-0"** and click **Apply**. The offset for all of the air terminals is updated, as shown in Figure 2-42.

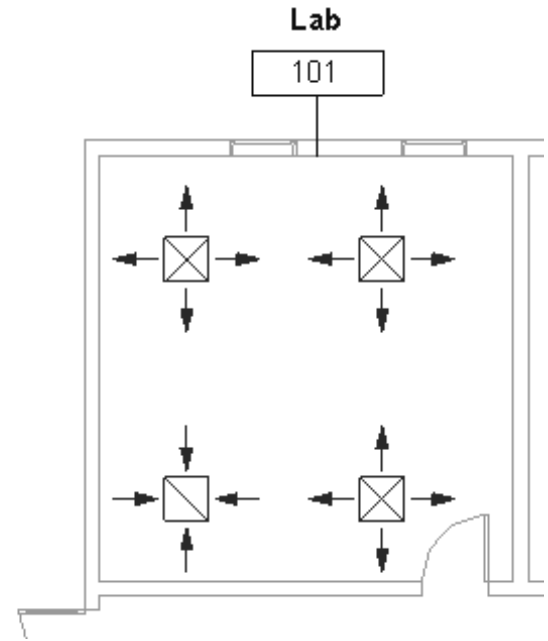
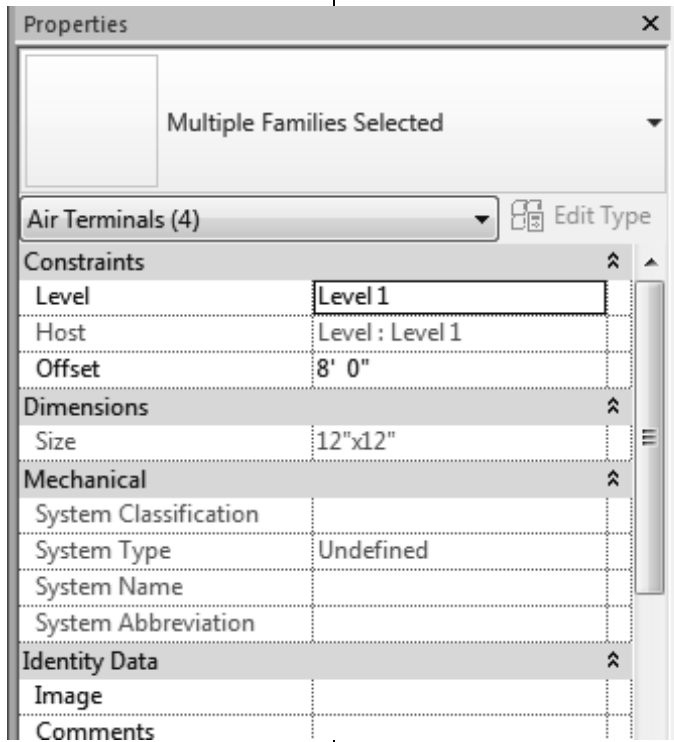

Figure 2-42

8. Click away from any elements to clear the selection.
9. Save the project.

# 2.4 Working with Basic Modify Tools

The basic modifying tools of **Move**, **Copy**, **Rotate**, **Mirror**, and **Array** can be used with individual elements or any selection of elements. They are found in the Modify panel (as shown in Figure 2–43), in the *Modify* tab, and in contextual tabs.

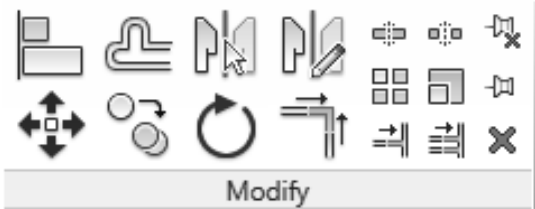

Figure 2–43

- For these modify commands, you can either select the elements and start the command, or start the command, select the elements, and press <Enter> to finish the selection and move to the next step in the command.

## Moving and Copying Elements

The **Move** and **Copy** commands enable you to select the element(s) and move or copy them from one place to another. You can use alignment lines, temporary dimensions, and snaps to help place the elements, as shown in Figure 2–44.

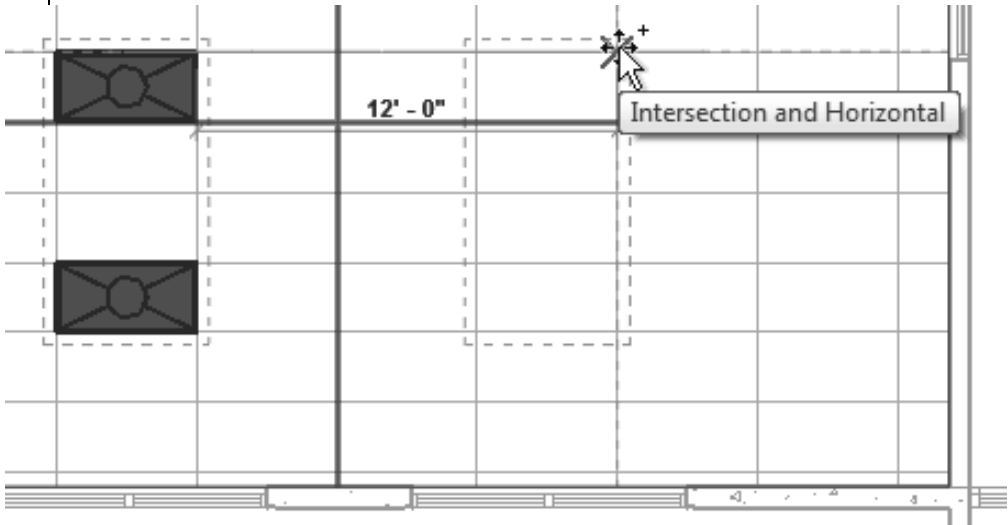



Figure 2–44

You can also use the shortcut for **Move**, **MV** or for **Copy**, **CO**.

## How To: Move or Copy Elements

1. Select the elements you want to move or copy.
  2. In the Modify panel, click  (Move) or  (Copy). A dashed boundary box displays around the selected elements.
  3. Select a move start point on or near the element.
  4. Select a second point. Use alignment lines and temporary dimensions to help place the elements.
  5. When you are finished, you can start another modify command using the elements that remain selected, or switch back to **Modify** to end the command.
- You can drag elements to new locations without starting the **Move** command. Holding <Ctrl> and dragging copies the element. This is quick but not very precise.

## Move/Copy Elements Options

The **Move** and **Copy** commands have several options that display in the Options Bar, as shown in Figure 2–45.

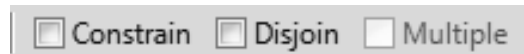





Figure 2–45

<b>Constrain</b>	Restricts the movement of the cursor to horizontal or vertical, or along the axis of an item that is at an angle. This keeps you from selecting a point at an angle by mistake. <b>Constrain</b> is off by default.
<b>Disjoin (Move only)</b>	Breaks any connections between the elements being moved and other elements. If <b>Disjoin</b> is on, the elements move separately. If it is off, the connected elements also move or stretch. <b>Disjoin</b> is off by default.
<b>Multiple (Copy only)</b>	Enables you to make multiple copies of one selection. <b>Multiple</b> is off by default.

These commands only work in the current view, not between views or projects. To copy between views or projects, in the

*Modify* tab>Clipboard panel, use  (Copy to Clipboard),  (Cut to the Clipboard), and  (Paste from Clipboard).

- If you do not want elements to be moved, select the elements and in the *Modify* tab, in the Modify panel, click  (Pin). Pinned elements can be copied, but not moved or deleted. Select the element and click the pin icon, as shown in Figure 2–46, or type the shortcut **UP** to free it.

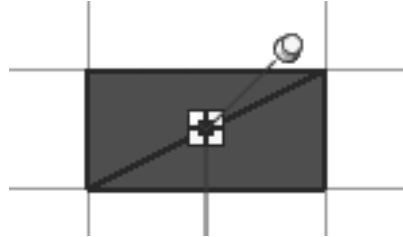

Figure 2–46

## Rotating Elements

The **Rotate** command enables you to rotate selected elements around a center point or origin, as shown in Figure 2–47. You can use alignment lines, temporary dimensions, and snaps to help specify the center of rotation and the angle. You can also create copies of the element as it is being rotated.

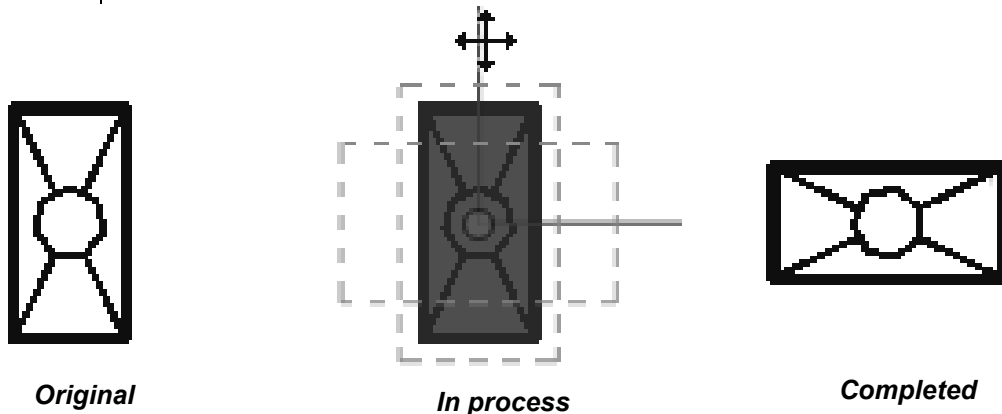



Figure 2–47

### How To: Rotate Elements

- Select the element(s) you want to rotate.
- In the Modify panel, click  (Rotate) or type the shortcut **RO**.

To start the **Rotate** command with a prompt to select the center of rotation, select the elements first and type **R3**.

You can also specify the angle on screen using temporary dimensions.

3. The center of rotation is automatically set to the center of the element or group of elements, as shown in Figure 2–48. To change the center of rotation, as shown in Figure 2–49, use the following:

- Drag the  (Center of Rotation) control to a new point.
- In the Options Bar, next to **Center of rotation**, click **Place** and use snaps to move it to a new location.
- Press <Spacebar> to select the center of rotation and click to move it to a new location.

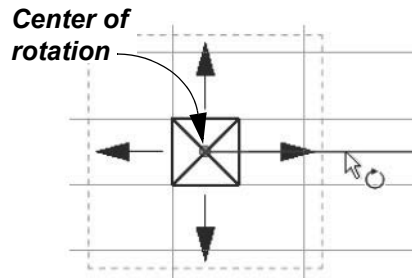

Figure 2–48

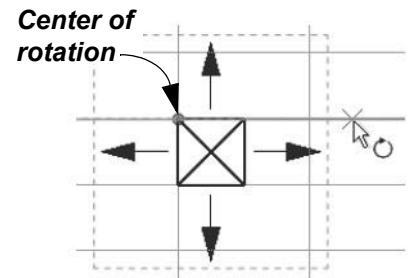

Figure 2–49

4. In the Options Bar (shown in Figure 2–50), specify the *Angle* and other options and press <Enter>.



Figure 2–50

- The **Disjoin** option breaks any connections between the elements being rotated and other elements. If **Disjoin** is on (selected), the elements rotate separately. If it is off (cleared), the connected elements also move or stretch, as shown for a wall in Figure 2–51. **Disjoin** is toggled off by default.

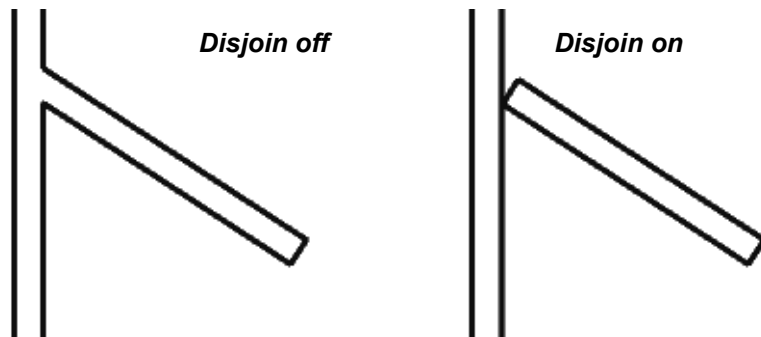

Figure 2–51

- Rotating connected MEP elements can easily cause connection and system problems.

## Mirroring Elements

The **Mirror** command enables you to mirror elements about an axis defined by a selected element, as shown in Figure 2–52, or by selected points.

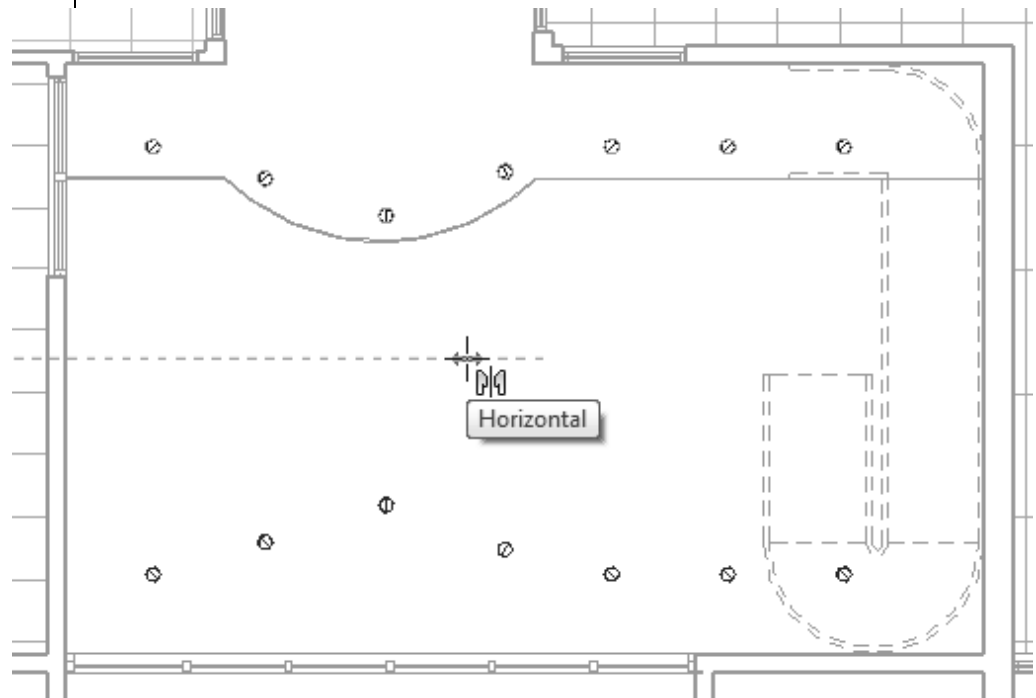





Figure 2–52

### How To: Mirror Elements

1. Select the element(s) to mirror.
2. In the Modify panel, select the method you want to use:
  - Click  (Mirror - Pick Axis) or type the shortcut **MM**. This prompts you to select an element as the **Axis of Reflection** (mirror line).
  - Click  (Mirror - Draw Axis) or type the shortcut **DM**. This prompts you to select two points to define the axis about which the elements mirror.
3. The new mirrored element(s) remain highlighted, enabling you to start another command, or return to **Modify** to finish.
  - By default, the original elements that were mirrored remain. To delete the original elements, clear the **Copy** option in the Options Bar.

## Creating Linear and Radial Arrays

### Hint: Scale

The Autodesk Revit software is designed with full-size elements. Therefore, not much can be scaled. However, you can use  (Scale) in reference planes, images, and imported files from other programs.

The **Array** command creates multiple copies of selected elements in a linear or radial pattern, as shown in Figure 2–53. For example, you can array a row of columns to create a row of evenly spaced columns on a grid, or array a row of parking spaces. The arrayed elements can be grouped or placed as separate elements.

- A linear array creates a straight line pattern of elements, while a radial array creates a circular pattern around a center point.

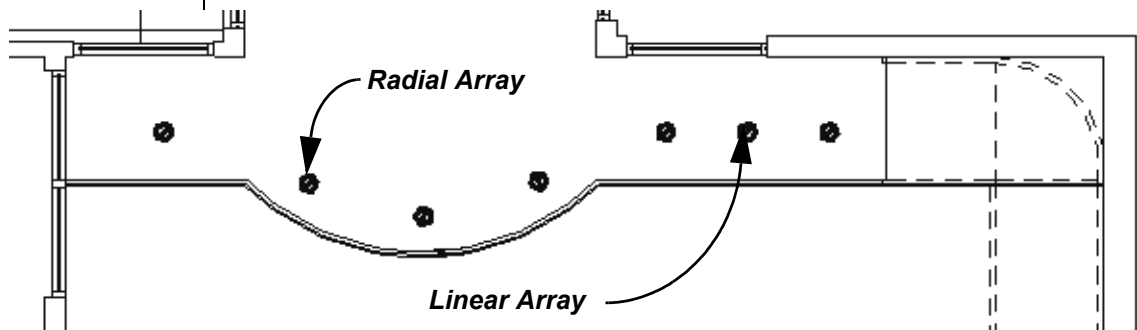



Figure 2–53

### How To: Create a Linear Array

1. Select the element(s) to array.
2. In the Modify panel, click  (Array) or type the shortcut **AR**.
3. In the Options Bar, click  (Linear).
4. Specify the other options as required.
5. Select a start point and an end point to set the spacing and direction of the array. The array is displayed.



6. If the **Group and Associate** option is selected, you are prompted again for the number of items, as shown in Figure 2–54. Type a new number or click on the screen to finish the command.

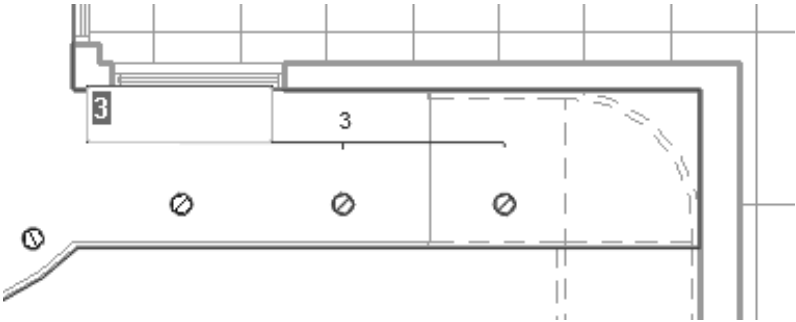

Figure 2–54

- To make a linear array in two directions, you need to array one direction first, select the arrayed elements, and then array them again in the other direction.

### Array Options

In the Options Bar, set up the **Array** options for **Linear Array** (top of Figure 2–55) or **Radial Array** (bottom of Figure 2–55).

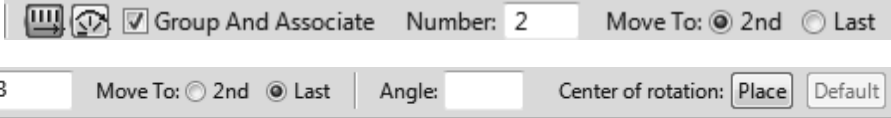





Figure 2–55

<b>Group and Associate</b>	Creates an array group element out of all arrayed elements. Groups can be selected by selecting any elements in the group.
<b>Number</b>	Specifies how many instances you want in the array.
<b>Move To:</b>	<b>2nd</b> specifies the distance or angle between the center points of the two elements. <b>Last</b> specifies the overall distance or angle of the entire array.
<b>Constrain</b>	Restricts the direction of the array to only vertical or horizontal (Linear only).
<b>Angle</b>	Specifies the angle (Radial only).
<b>Center of rotation</b>	Specifies a location for the origin about which the elements rotate (Radial only).

## How To: Create a Radial Array

1. Select the element(s) to array.
2. In the Modify panel, click  (Array).
3. In the Options Bar, click  (Radial).
4. Drag  (Center of Rotation) or in the Options Bar click **Place** to the move the center of rotation to the appropriate location, as shown in Figure 2–56.

*Remember to set the **Center of Rotation** control first, because it is easy to forget to move it before specifying the angle.*

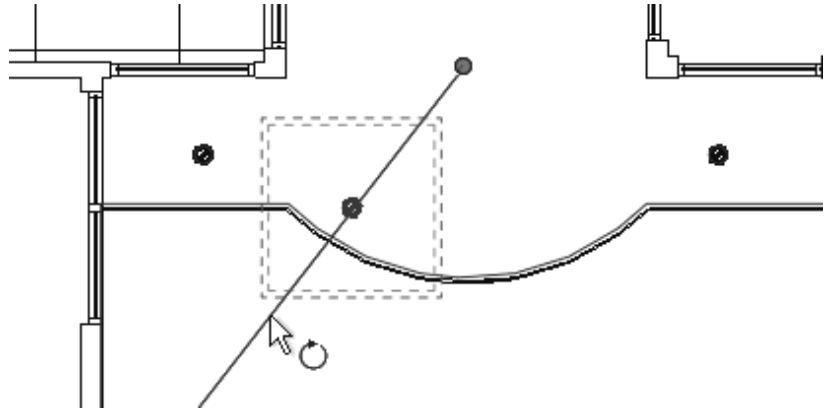

Figure 2–56

5. Specify the other options as required.
6. In the Options Bar, type an angle and press <Enter>, or specify the rotation angle by selecting points on the screen.

## Modifying Array Groups

When you select an element in an array that has been grouped, you can change the number of instances in the array, as shown in Figure 2–57. For radial arrays you can also modify the distance to the center.

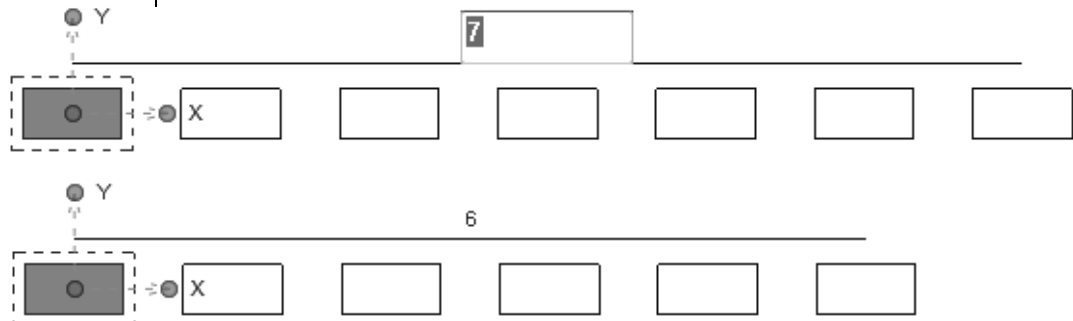
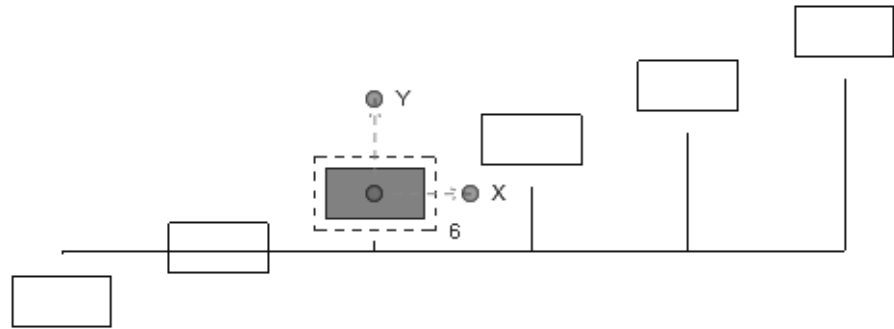





Figure 2–57

- Dashed lines surround the element(s) in a group, and the XY control lets you move the origin point of the group

If you move one of the elements in the array group, the other elements move in response based on the distance and/or angle, as shown in Figure 2–58.



**Figure 2–58**

- To remove the array constraint on the group, select all of the elements in the array group and, in the *Modify* contextual tab>Group panel, click  (Ungroup).
- If you select an individual element in an array and click  (Ungroup), the element you selected is removed from the array, while the rest of the elements remain in the array group.
- You can use  (Filter) to ensure that you are selecting only **Model Groups**.

## Practice 2c

# Work with Basic Modify Tools

### Practice Objective

- Use basic modify tools, including Move, Copy, Rotate, Mirror, and Array

In this practice, you will copy air terminals to several rooms and move some so they fit the room logically. You will array plumbing fixtures in a restroom and then mirror them to the other restroom. Finally, you will rotate lighting fixtures to fit an angled ceiling grid, as shown in Figure 2–59.

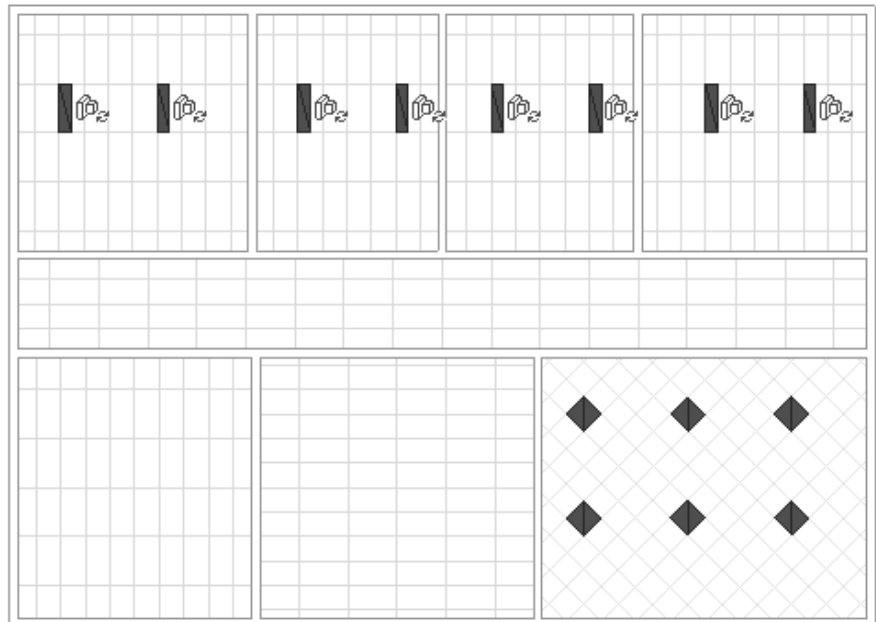

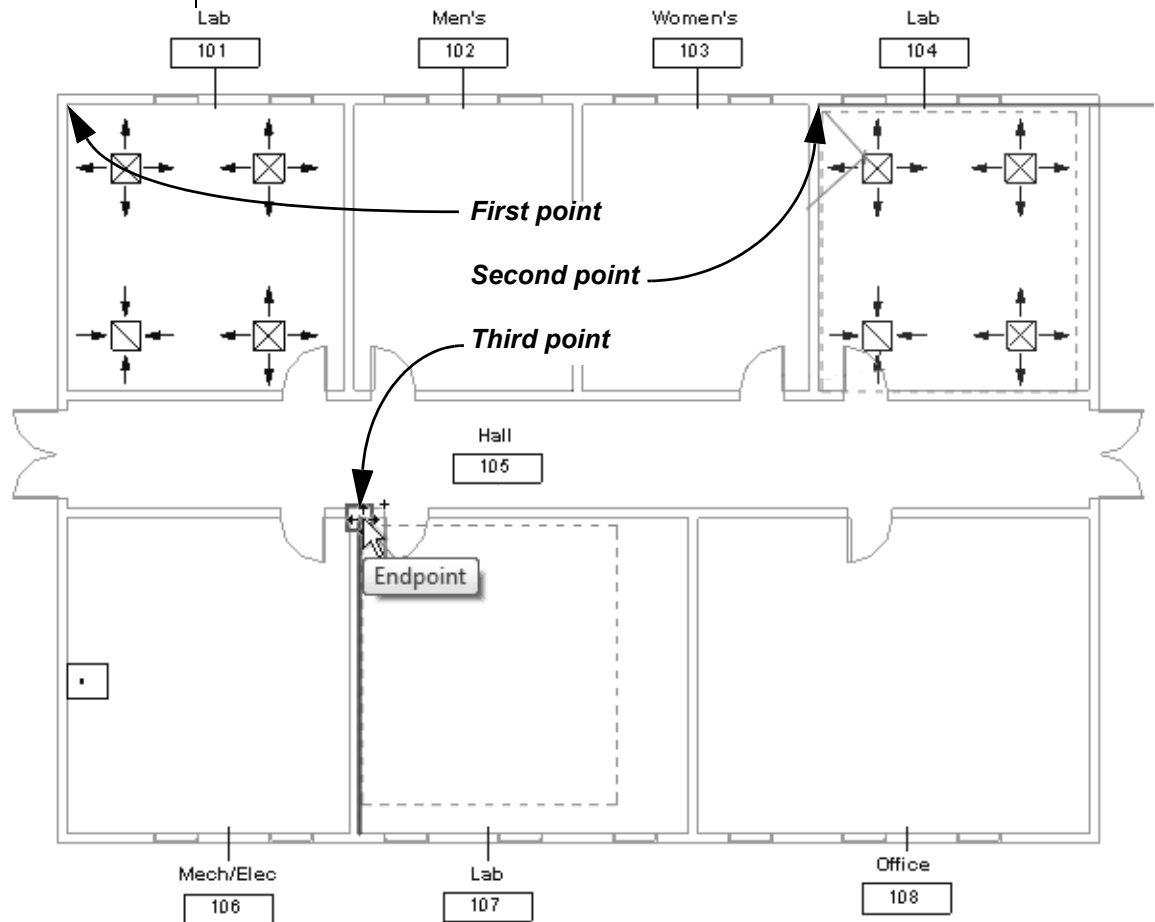

Figure 2–59



### Task 1 - Copy elements.

1. In the practice files *Basics* folder, open **Simple-Building-Modify.rvt**.
2. Open the Mechanical>HVAC>Floor Plans>**1 - Mech** view.
3. Select the four air terminals.
4. In the *Modify | Air Terminals* tab>Modify panel, click  (Copy).

5. In the Options Bar, select **Multiple**.
6. Select the following points, as shown in Figure 2–60:
  - *First point:* **Lab 101**
  - *Second point:* **Lab 104**
  - *Third point:* **Lab 107**



**Figure 2–60**

7. The air terminals are copied into each room.
8. Click  (Modify).
9. In the *Modify* tab>Modify panel, click  (Move).
10. As there is no current selection, you need to select the elements to move. In **Lab 107**, select the two air terminals on the right and then press <Enter>.

11. Select a base point on one of the air terminals and then use temporary dimensions to move the air terminals **4'-0"**, as shown in Figure 2-61.

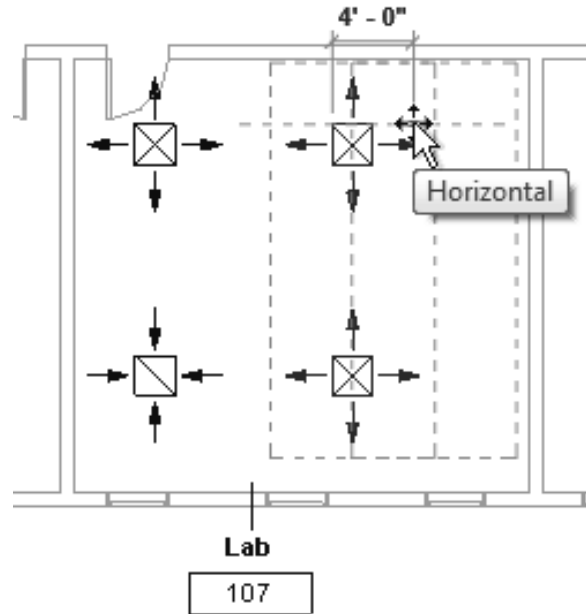



Figure 2-61

12. Save the project.

---

### Task 2 - Array and mirror elements.

---

1. Open the Plumbing>Floor Plans>**1 - Plumbing** view.
2. Select the WC and lavatory.
3. In the *Modify | Plumbing Fixtures* tab>Modify panel, click  (Array).
4. In the Options Bar, review the defaults.
5. Pick the first point near one of the fixtures and a second point **3'-0"** below using temporary dimensions.

6. You are prompted again for the number of elements, as shown in Figure 2–62.
7. Change the number to **4**, and then press <Enter>. The additional fixtures are placed, as shown in Figure 2–63.

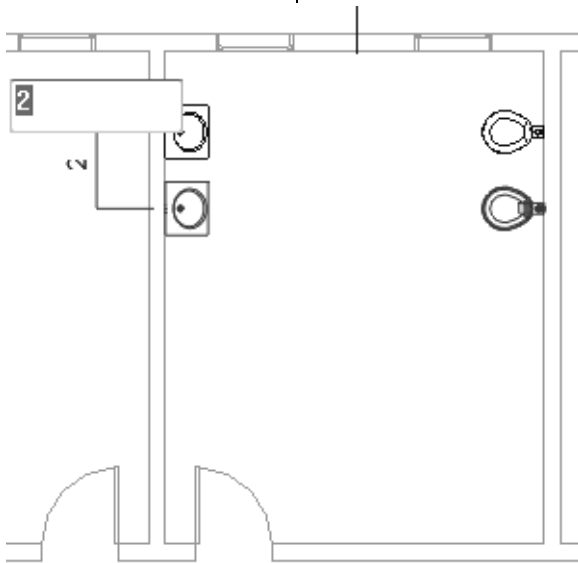

Figure 2–62

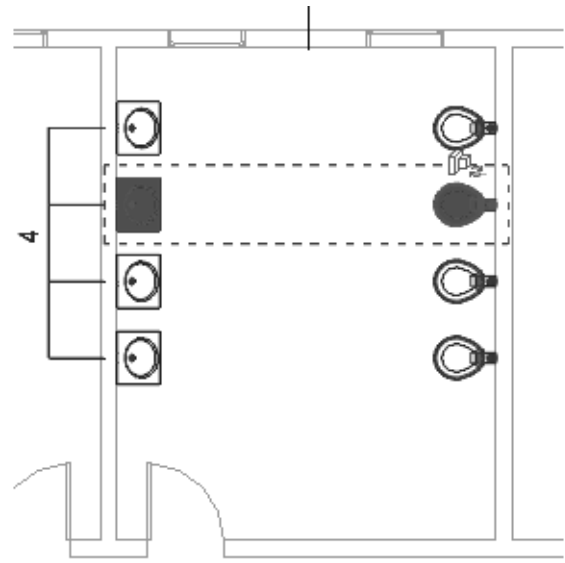



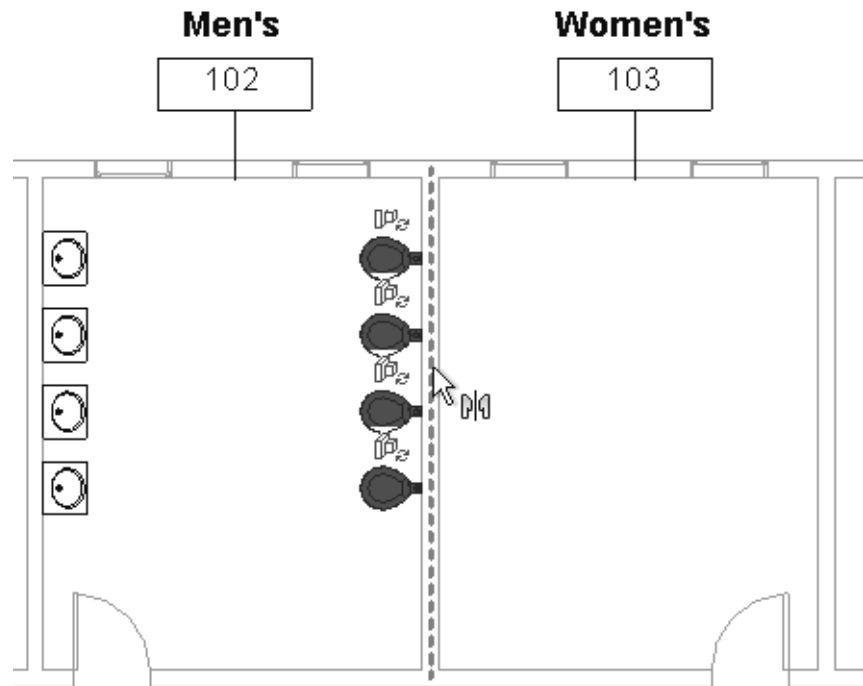

Figure 2–63

8. Click  (Modify) and select all of the fixtures. They are grouped together.
9. In the *Modify | Model Groups* tab>Group panel, click  (Ungroup). Each element can now be moved separately.
10. Click  (Modify) and select the WCs.
11. In the *Modify | Plumbing Fixtures* tab>Modify panel, click  (Mirror - Pick Axis).

12. Select the wall between rooms **102** and **103**, as shown in Figure 2–64.



**Figure 2–64**

*Note that mirroring the lavatories reverses the hot and cold water connectors.*

13. Select one of the lavatories, right-click and select **Create Similar**.
14. Place the lavatory across from the WC in the Women's room.
15. Click  (Modify), select and drag the lavatory into place.
16. With the lavatory still selected, start the **Array** command.
17. In the Options Bar, clear the **Group and Associate** option and set *Number* to **4**.
18. Click a base point on the lavatory, and then click a second point **3'-0"** below it. Four lavatories are now placed, which do not need to be ungrouped.
19. Select two of the WCs in Room **102**. In the Type selector, change the type to **Urinal - Wall Hung: 3/4" Flush Valve**.
20. Save the project.



### Task 3 - Copy and rotate elements.

1. Open the Electrical>Lighting>Ceiling Plans>1 - Ceiling Elec view.
2. Copy the lighting fixtures to the other rooms on the same side of the hall, similar to the example shown in Figure 2–65.

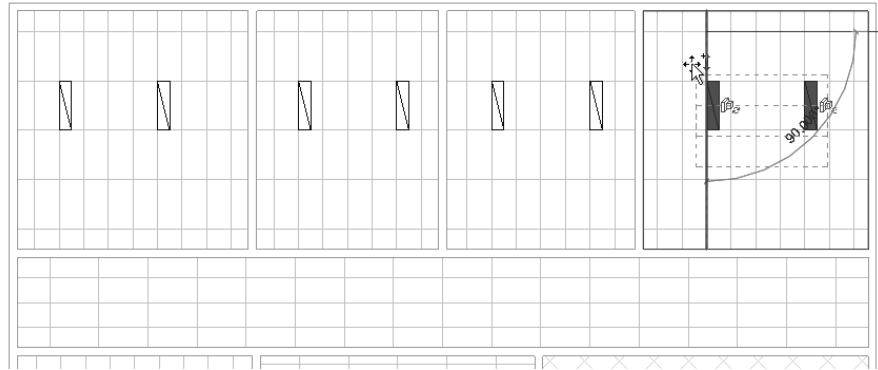



Figure 2–65

3. Add a **Plain Recessed Lighting Fixture: 2x2 - 277** type lighting fixture to the room with the 45 degree ceiling. (Remember to use **Place on Face**.)
4. Click  (Modify) and select the new square lighting fixture.
5. In the *Modify | Lighting Fixtures tab*>Modify panel, click  (Rotate).
6. Drag the center control over to the edge, as shown in Figure 2–66. Click when the cursor displays a horizontal line and then on the nearby 45 degree angled line, as shown in Figure 2–67. The fixture now fits in the grid.

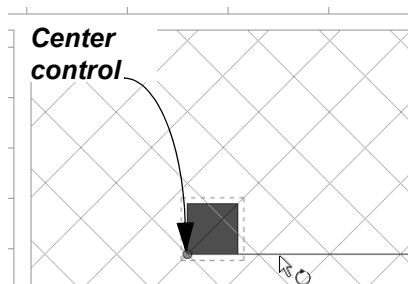

Figure 2–66

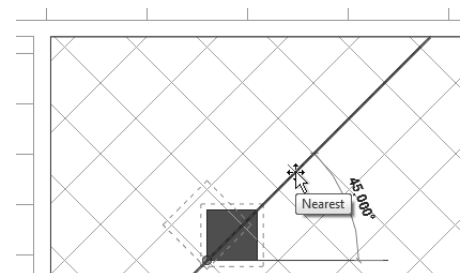

Figure 2–67

7. Copy the fixture to additional places in the room.
8. Save the project.

## 2.5 Working with Additional Modify Tools

As you work on a project, some additional tools on the *Modify* tab>Modify panel, as shown in Figure 2–68, can help you with placing, modifying, and constraining elements. **Align** can be used with a variety of elements, while **Split Element**, **Trim/Extend**, and **Offset** can only be used with linear elements.

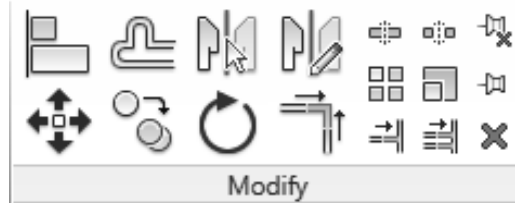

Figure 2–68

### Aligning Elements

The **Align** command enables you to line up one element with another. Most Autodesk Revit elements can be aligned. For example, you can line up an air terminal with ceiling grids, as shown in Figure 2–69.

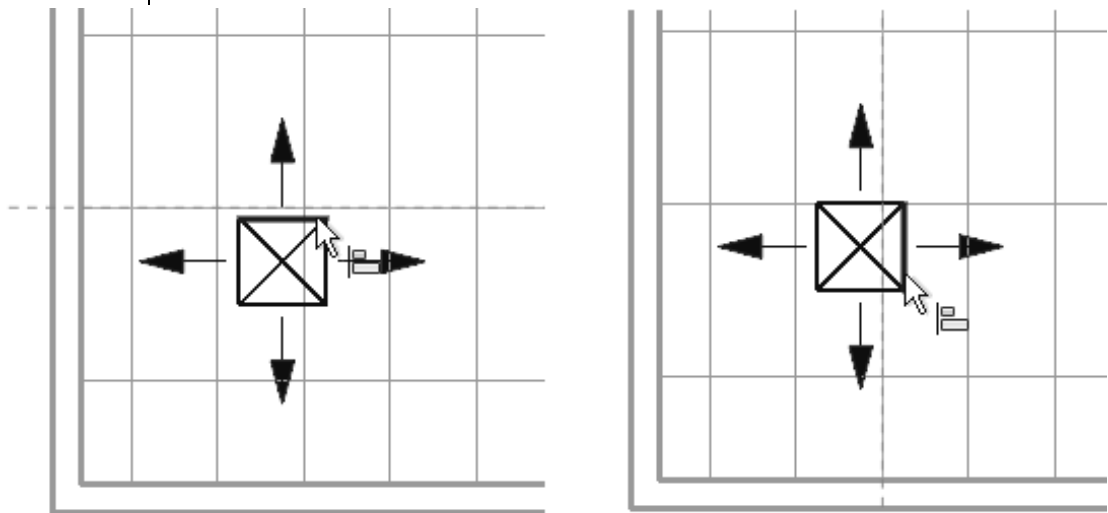

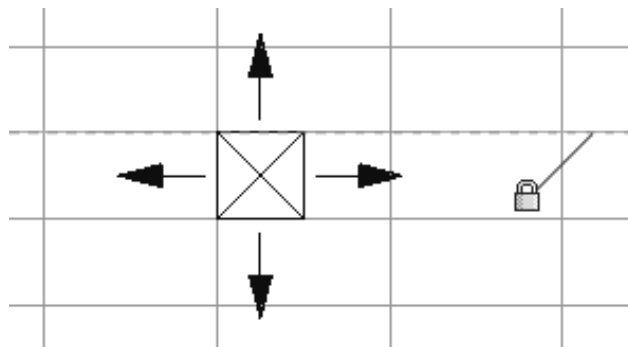

Figure 2–69

## How To: Align Elements

1. In the *Modify* tab>Modify panel, click  (Align).
  2. Select a line or point on the element that is going to remain stationary. For walls, press <Tab> to select the correct wall face.
  3. Select a line or point on the element to be aligned. The second element moves into alignment with the first one.
- The **Align** command works in all model views, including parallel and perspective 3D views.
  - You can lock alignments so that the elements move together if either one is moved. Once you have created the alignment, a padlock is displayed. Click on the padlock to lock it, as shown in Figure 2–70.

*Locking elements enlarges the size of the project file, so use this option carefully.*



**Figure 2–70**

- Select **Multiple Alignment** to select multiple elements to align with the first element. You can also hold <Ctrl> to make multiple alignments.
- For walls, you can specify if you want the command to prefer **Wall centerlines**, **Wall faces**, **Center of core**, or **Faces of core**, as shown in Figure 2–71. The core refers to the structural members of a wall as opposed to facing materials, such as sheet rock.

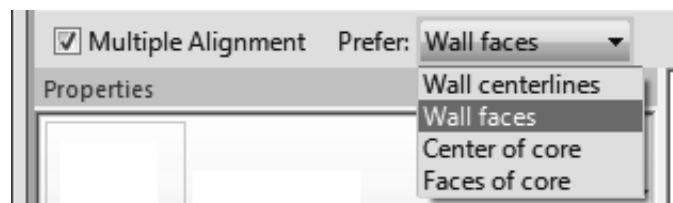

**Figure 2–71**

## Splitting Linear Elements

The **Split Element** command enables you to break a linear element at a specific point. You can use alignment lines, snaps, and temporary dimensions to help place the split point. After you have split the linear element, you can use other editing commands to modify the two parts, or change the type of one part, as shown with walls in Figure 2–72.

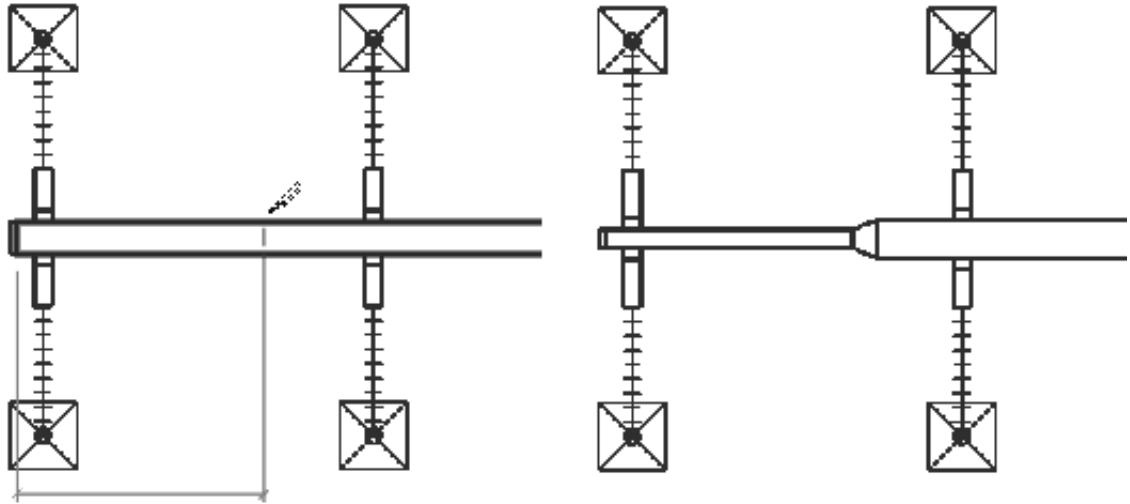



Figure 2–72

### How To: Split Linear Elements

1. In the *Modify* tab>Modify panel, click  (Split Element) or type the shortcut **SL**.
  2. In the Options Bar, select or clear the **Delete Inner Segment** option.
  3. Move the cursor to the point you want to split and select the point.
  4. Repeat for any additional split locations.
  5. Modify the elements that were split, as required.
- The **Delete Inner Segment** option is used when you select two split points along a linear element. When the option is selected, the segment between the two split points is automatically removed.

## Trimming and Extending

There are three trim/extend methods that you can use with linear elements: **Trim/Extend to Corner**, **Trim/Extend Single Element**, and **Trim/Extend Multiple Elements**.

- When selecting elements to trim, click the part of the element that you want to keep. The opposite part of the line is then trimmed.

## How To: Trim/Extend to Corner

1. In the *Modify* tab>Modify panel, click  (Trim/Extend to Corner) or type the shortcut **TR**.
2. Select the first linear element on the side you want to keep.
3. Select the second linear element on the side you want to keep, as shown in Figure 2–73.

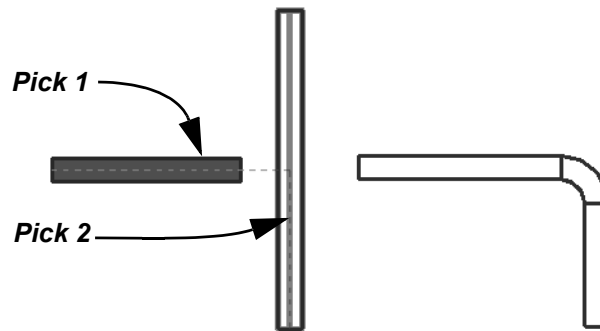



Figure 2–73

## How To: Trim/Extend a Single Element

1. In the *Modify* tab>Modify panel, click  (Trim/Extend Single Element).
2. Select the cutting or boundary edge.
3. Select the linear element to be trimmed or extended, as shown in Figure 2–74.

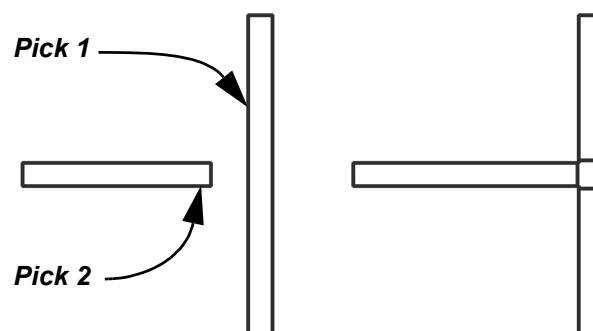



Figure 2–74

## How To: Trim/Extend Multiple Elements

1. In the *Modify* tab>Modify panel, click  (Trim/Extend Multiple Elements).
2. Select the cutting or boundary edge.

3. Select the linear elements that you want to trim or extend by selecting one at a time, or by using a crossing window, as shown in Figure 2–75. For trimming, select the side you want to keep.

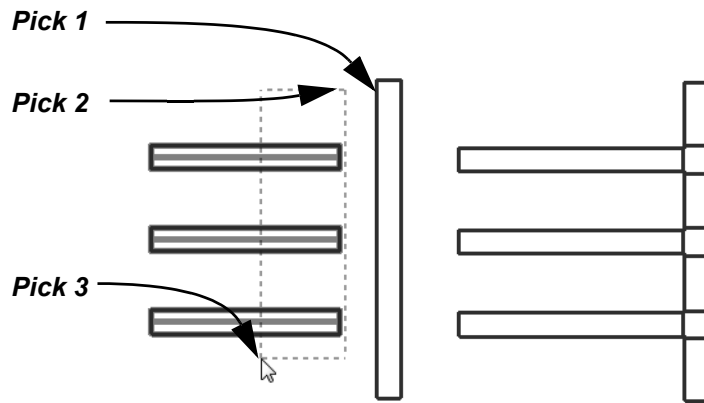

Figure 2–75

- You can click in an empty space to clear the selection and select another cutting edge or boundary.

## Offsetting Elements

*MEP elements can be offset, but you should typically use other tools to create parallel elements, such as ducts, pipes, and conduits.*

The **Offset** command is an easy way of creating parallel copies of linear elements at a specified distance, as shown in Figure 2–76. Walls, beams, braces, and lines are among the elements that can be offset.

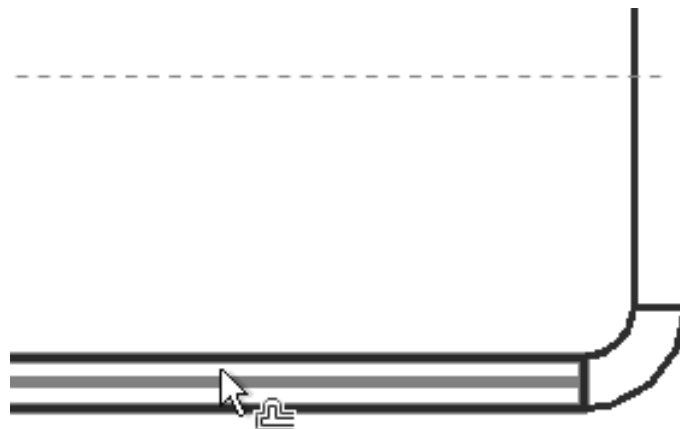

Figure 2–76

The offset distance can be set by typing the distance (**Numerical** method shown in Figure 2–77) or by selecting points on the screen (**Graphical** method).

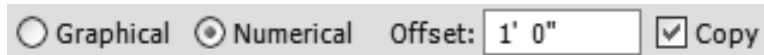



Figure 2–77

The **Copy** option (which is on by default) makes a copy of the element being offset. If this option is not selected, the **Offset** command moves the element the set offset distance.

The offset is from centerline to centerline of elements, such as duct or pipe.

Most linear elements connected at a corner automatically trim or extend to meet at the offset distance.

## How To: Offset using the Numerical Method

1. In the *Modify* tab>Modify panel, click  (Offset) or type the shortcut **OF**.
  2. In the Options Bar, select the **Numerical** option.
  3. In the Options Bar, type the required distance in the *Offset* field.
  4. Move the cursor over the element you want to offset. A dashed line previews the offset location. Move the cursor to flip the sides, as required.
  5. Click to create the offset.
  6. Repeat Steps 4 and 5 to offset other elements by the same distance, or to change the distance for another offset.
- With the **Numerical** option, you can select multiple connected linear elements for offsetting. Hover the cursor over an element and press <Tab> until the other related elements are highlighted, as shown in Figure 2–78. Select the element to offset all of the elements at the same time.

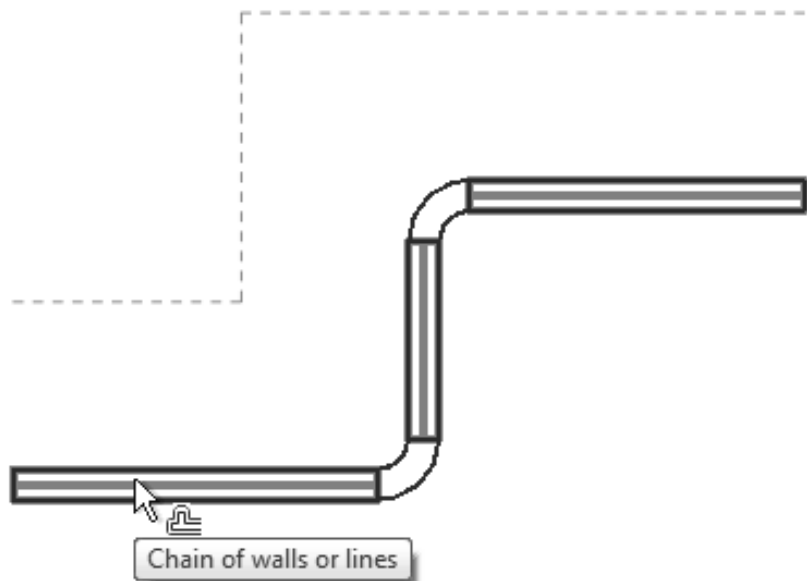



Figure 2–78

## How To: Offset using the Graphical Method

1. Start the **Offset** command.
2. In the Options Bar, select the **Graphical** option.
3. Select the linear element to offset.
4. Select two points that define the distance of the offset and which side to apply it. You can type an override in the temporary dimension for the second point.

**Hint: Using Thin Lines**

The software automatically applies line weights to views, as shown for a section on the left in Figure 2–79. If a line weight seems heavy or obscures your work on the elements, toggle off the line weights. In the Quick Access Toolbar or in the View

tab>Graphics panel, click  (Thin Lines) or type **TL**. The lines display with the same weight, as shown on the right in Figure 2–79.



*Thin Lines Off*

*Thin Lines On*

**Figure 2–79**

- The **Thin Line** setting is remembered until you change it, even if you shut down and restart the software.



## Practice 2d

# Work with Additional Modify Tools

### Practice Objective

- Use Align, Split, Offset and Trim/Extend.

In this practice, you will discover and delete excess piping and clean it up with modify tools. You will align air terminals to ceiling grids. Finally you will offset cable trays and use trim/extend commands to link them. You will also split and resize part of the tray, as shown in Figure 2–80.

- Additional linear elements, including pipes and cable trays have been added to this practice.

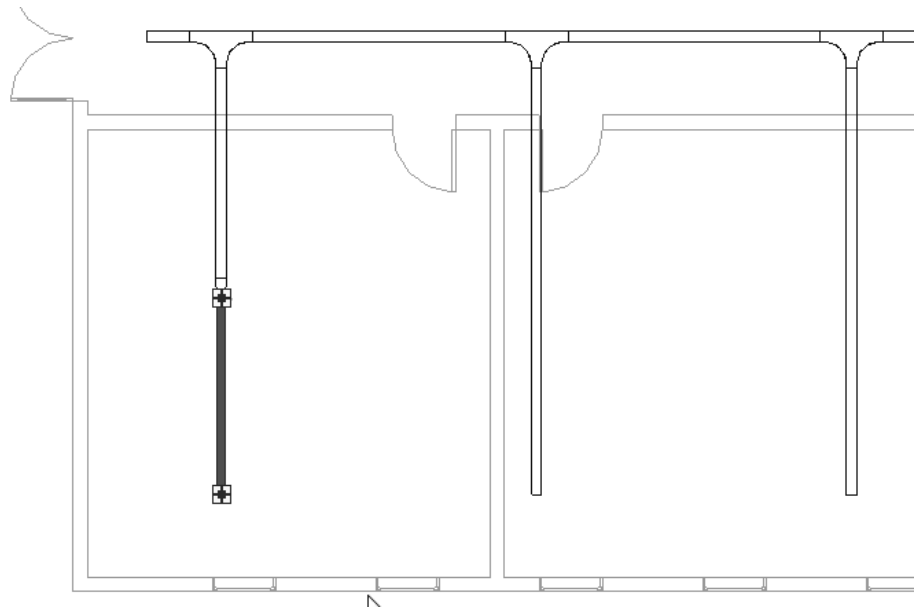





Figure 2–80

### Task 1 - Clean up excess piping.

1. In the practice files *Basics* folder, open **Simple-Building-Align.rvt**.
2. In the Plumbing > 3D Views: **3D Plumbing** view, zoom in on the connection between the hot water heater and the pipe in the hall to display the open connector.
3. In the View Control Bar, change the *Detail Level* to  (Fine) and the Visual Style to  (Shaded) to help display the pipes more clearly.

4. If required, in the Quick Access Toolbar, click  (Thin Lines) to see the piping better.
5. Delete the extra pipe and connectors between the pipes, as shown in Figure 2–81.

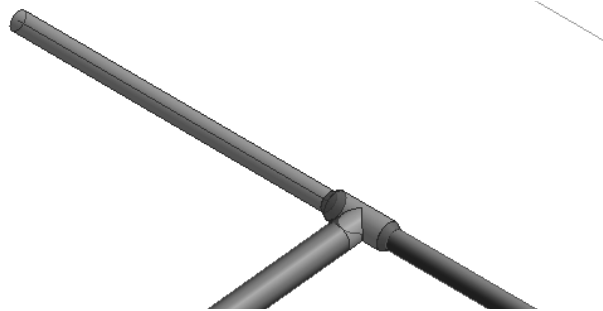



Figure 2–81

6. In the *Modify* tab>Modify panel, click  (Trim/Extend to Corner).
7. Select the two pipes, as shown in Figure 2–82. Ensure that you select the smaller pipe first so that the elbow connector uses the size of the larger pipe, as shown in Figure 2–83.

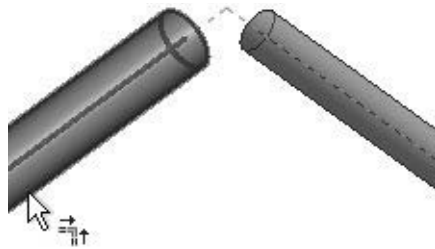

Figure 2–82



Figure 2–83

8. Type **ZF** to zoom the model to fit the view.
9. Save the project

---

**Task 2 - Align air terminals to ceiling grids.**

---

1. Open the Mechanical>HVAC>Ceiling Plans>**1-Ceiling Mech** view.
2. Zoom in on the lab room in the upper left corner.
3. In the *Modify* tab>Modify panel, click  (Align).

- 4. Select a vertical grid line and then the side of the air terminal, as shown in Figure 2–84.

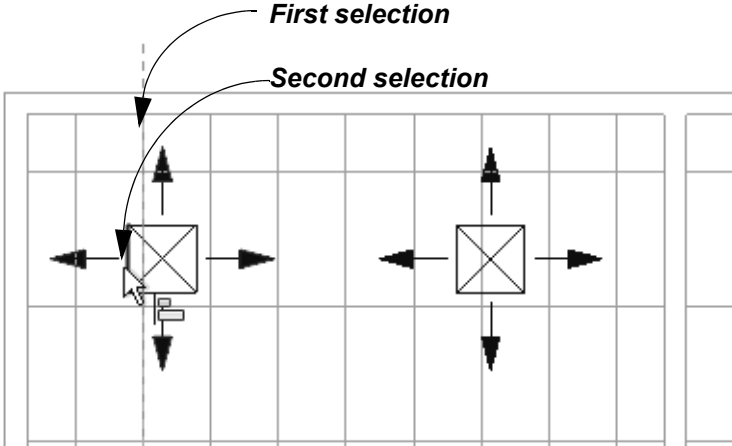

Figure 2–84

- 5. While still in the **Align** command, in the Options Bar, select **Multiple Alignment**.
- 6. Without stopping, select the following items in the order listed, as shown in Figure 2–85:
  - Horizontal grid line
  - Horizontal edge of the first air terminal
  - Horizontal edge of the 2nd air terminal

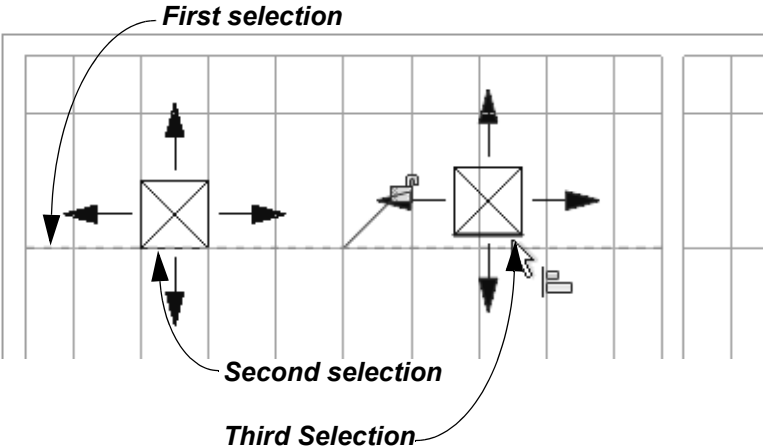

Figure 2–85

- 7. Press <Esc> once. This keeps you in the command but releases the alignment line.

8. Align the other air terminals to the ceiling grid, as shown in Figure 2–86.

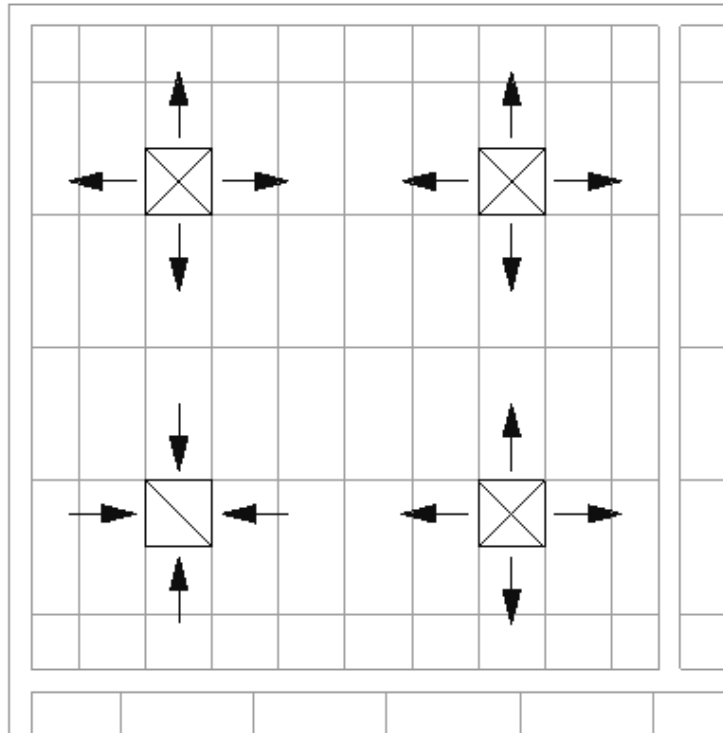



Figure 2–86

9. Use the **Align** tool with or without the multiple alignment (see which works the best for you) to move the air terminals in the other lab rooms.
10. Zoom to fit the view and then save the project.

---

### Task 3 - Offset, Trim and Split cable trays.

---

1. Open the Electrical>Power>Floor Plans>1 - **Power** view.
2. In the *Modify* tab>Modify panel, click  (Offset).
3. In the Options Bar, select **Numerical**, set the *Offset* to **15'-0"**, and ensure that **Copy** is selected.
4. Hover the cursor over the vertical cable tray and ensure that the alignment line is to the right, as shown in Figure 2–87. Click to create the copy.

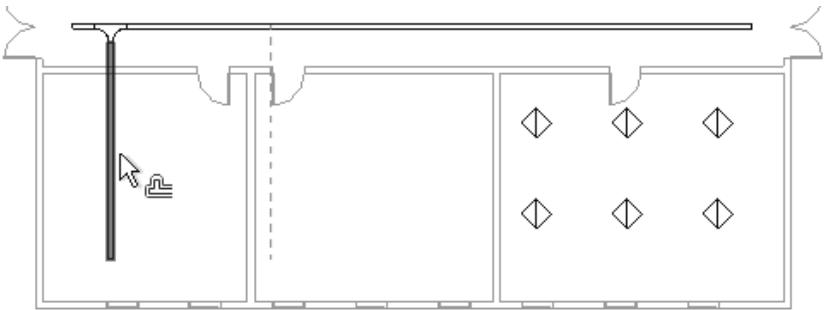

Figure 2-87

- 5. Select the new cable tray (ensuring that the offset is to the right) and continue until there are five total trays, as shown in Figure 2-88.

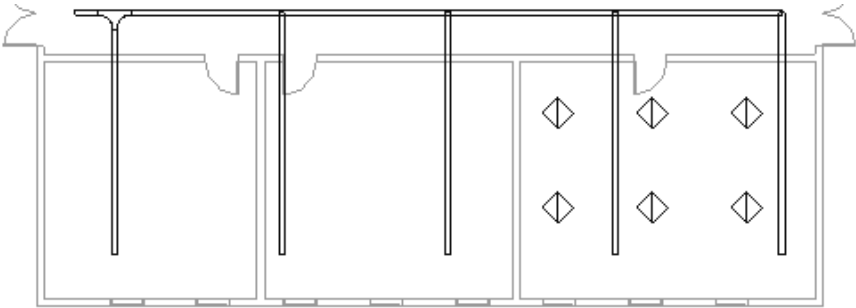



Figure 2-88

- 6. Click **Modify**.
- 7. In the *Modify* tab>Modify panel, click  (Trim/Extend Multiple Elements).
- 8. Select the horizontal cable tray and then draw a crossing window from right to left, as shown in Figure 2-89.

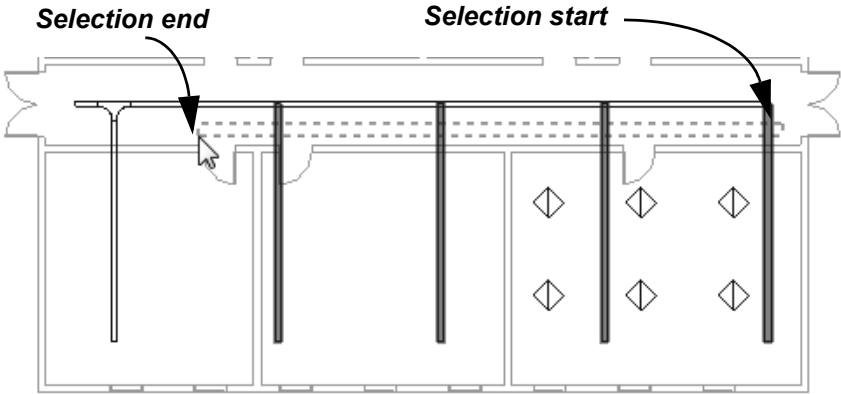



Figure 2-89

9. The cable trays are extended and fittings applied, as shown in Figure 2–90. The last cable tray does not clean up, use the  (Trim/Extend to Corner) command to finish it.

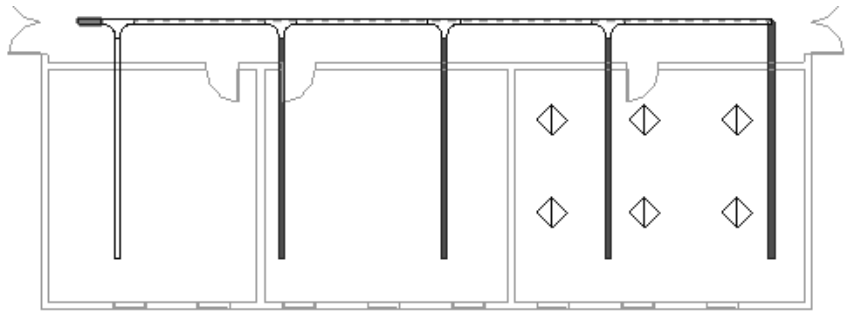



Figure 2–90

10. In the *Modify* tab>Modify panel, click  (Split Element).
11. Select the point on the vertical cable tray shown in Figure 2–91. The cable tray is split and fittings are applied.

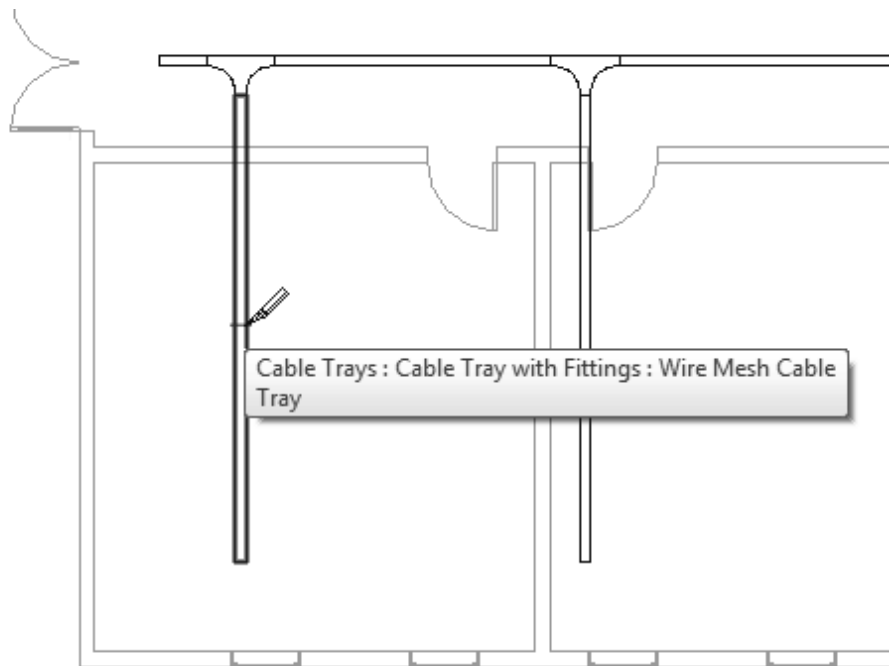

Figure 2–91

12. Click **Modify** and select the lower part of the tray. In the Options Bar, change the *Width* to **4"**. The size changes and the fitting is applied.
- **Note:** You will learn how to justify cable tray in *Chapter 11.5 Adding Cable Trays and Conduit*
13. Save the project.

## Chapter Review Questions

1. What is the purpose of an alignment line?
  - a. Displays when the new element you are placing or drawing is aligned with the grid system.
  - b. Indicates that the new element you are placing or drawing is aligned with an existing element.
  - c. Displays when the new element you are placing or drawing is aligned with a selected tracking point.
  - d. Indicates that the new element is aligned with true north rather than project north.
2. Which of the following commands imports a component (such as the sink shown in Figure 2–92) that is not available in your project?

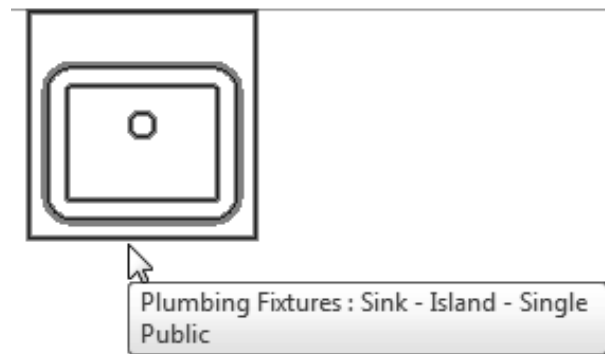

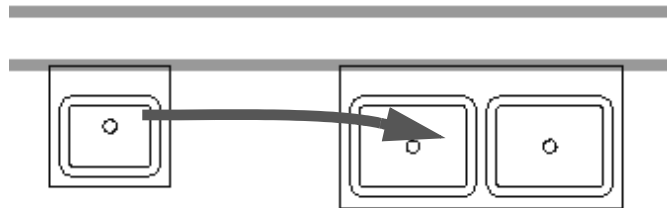



Figure 2–92

- a. **Load Family**
- b. **Load Equipment**
- c. **Load Component**
- d. **Load Fixture**



3. How do you select all Lighting Fixture of various sizes, but no other elements in a view?
  - a. In the Project Browser, select the *Lighting Fixtures* category.
  - b. Select one Lighting Fixture, right-click and select **Select All Instances>Visible in View**.
  - c. Select all of the elements in the view and use  (Filter) to clear the other categories.
  - d. Select one Lighting Fixture and click  (Select Multiple) in the ribbon.
  
4. What are the two methods for starting commands such as **Move, Copy, Rotate, Mirror, and Array**? Start the command from the *Modify* tab and select the elements, or...
  - a. Select the elements and then start the command.
  - b. Select the elements and then select the command from the Status Bar.
  - c. Select the elements, right-click and select the command from the list.
  
5. Where do you change the type for a selected plumbing fixture, as shown in Figure 2–93?

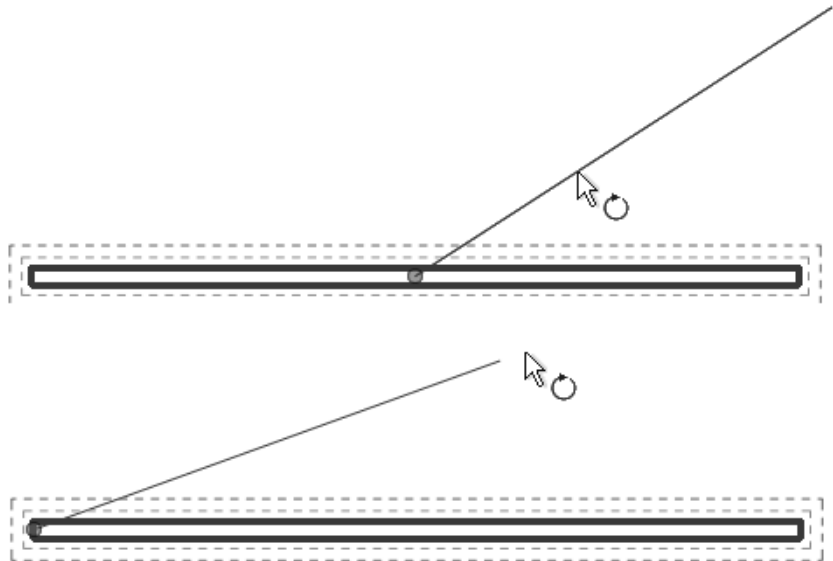

**Figure 2–93**





- a. In the *Modify | Plumbing Fixtures* tab>Properties panel, click  (Type Properties) and select a new type in the dialog box.
- b. In the Options Bar, click **Change Element Type**.
- c. Select the dynamic control next to the selected plumbing fixture and select a new type in the drop-down list.
- d. In Properties, select a new type in the Type Selector drop-down list.



















6. Both  (Rotate) and  (Array) with  (Radial) have a center of rotation that defaults to the center of the element or group of elements you have selected. How do you move the center of rotation to another point as shown in Figure 2–94? (Select all that apply.)











**Figure 2–94**

- a. Select the center of rotation and drag it to a new location.
  - b. In the Options Bar, click **Place** and select the new point.
  - c. In the *Modify* tab>Placement panel, click  (Center) and select the new point.
  - d. Right-click and select **Snap Overrides>Centers** and select the new point.
7. Which command would you use to break part of a duct so that you can change the duct type?
- a.  (Align)
  - b.  (Split)
  - c.  (Trim)
  - d.  (Offset)

# Command Summary

Button	Command	Location
<b>Modify Tools</b>		
	<b>Array</b>	<ul style="list-style-type: none"> <li>• <b>Ribbon:</b> <i>Modify</i> tab&gt;Modify panel</li> <li>• <b>Shortcut:</b> AR</li> </ul>
	<b>Copy</b>	<ul style="list-style-type: none"> <li>• <b>Ribbon:</b> <i>Modify</i> tab&gt;Modify panel</li> <li>• <b>Shortcut:</b> CO</li> </ul>
	<b>Copy to Clipboard</b>	<ul style="list-style-type: none"> <li>• <b>Ribbon:</b> <i>Modify</i> tab&gt;Clipboard panel</li> <li>• <b>Shortcut:</b> &lt;Ctrl&gt;+&lt;C&gt;</li> </ul>
	<b>Delete</b>	<ul style="list-style-type: none"> <li>• <b>Ribbon:</b> <i>Modify</i> tab&gt;Modify panel</li> <li>• <b>Shortcut:</b> DE</li> </ul>
	<b>Mirror - Draw Axis</b>	<ul style="list-style-type: none"> <li>• <b>Ribbon:</b> <i>Modify</i> tab&gt;Modify panel</li> <li>• <b>Shortcut:</b> DM</li> </ul>
	<b>Mirror - Pick Axis</b>	<ul style="list-style-type: none"> <li>• <b>Ribbon:</b> <i>Modify</i> tab&gt;Modify panel</li> <li>• <b>Shortcut:</b> MM</li> </ul>
	<b>Move</b>	<ul style="list-style-type: none"> <li>• <b>Ribbon:</b> <i>Modify</i> tab&gt;Modify panel</li> <li>• <b>Shortcut:</b> MV</li> </ul>
	<b>Paste</b>	<ul style="list-style-type: none"> <li>• <b>Ribbon:</b> <i>Modify</i> tab&gt;Clipboard panel</li> <li>• <b>Shortcut:</b> &lt;Ctrl&gt;+&lt;V&gt;</li> </ul>
	<b>Pin</b>	<ul style="list-style-type: none"> <li>• <b>Ribbon:</b> <i>Modify</i> tab&gt;Modify panel</li> <li>• <b>Shortcut:</b> PN</li> </ul>
	<b>Rotate</b>	<ul style="list-style-type: none"> <li>• <b>Ribbon:</b> <i>Modify</i> tab&gt;Modify panel</li> <li>• <b>Shortcut:</b> RO</li> </ul>
	<b>Scale</b>	<ul style="list-style-type: none"> <li>• <b>Ribbon:</b> <i>Modify</i> tab&gt;Modify panel</li> <li>• <b>Shortcut:</b> RE</li> </ul>
	<b>Unpin</b>	<ul style="list-style-type: none"> <li>• <b>Ribbon:</b> <i>Modify</i> tab&gt;Modify panel</li> <li>• <b>Shortcut:</b> UP</li> </ul>
<b>Modify Tools</b>		
	<b>Align</b>	<ul style="list-style-type: none"> <li>• <b>Ribbon:</b> <i>Modify</i> tab&gt;Modify panel</li> <li>• <b>Shortcut:</b> AL</li> </ul>
	<b>Offset</b>	<ul style="list-style-type: none"> <li>• <b>Ribbon:</b> <i>Modify</i> tab&gt;Modify panel</li> <li>• <b>Shortcut:</b> OF</li> </ul>
	<b>Split Element</b>	<ul style="list-style-type: none"> <li>• <b>Ribbon:</b> <i>Modify</i> tab&gt;Modify panel</li> <li>• <b>Shortcut:</b> SL</li> </ul>
	<b>Trim/Extend Multiple Elements</b>	<ul style="list-style-type: none"> <li>• <b>Ribbon:</b> <i>Modify</i> tab&gt;Modify panel</li> </ul>

	<b>Trim/Extend Single Element</b>	<ul style="list-style-type: none"> <li>• <b>Ribbon:</b> <i>Modify</i> tab&gt;Modify panel</li> </ul>
	<b>Trim/Extend to Corner</b>	<ul style="list-style-type: none"> <li>• <b>Ribbon:</b> <i>Modify</i> tab&gt;Modify panel</li> <li>• <b>Shortcut:</b> TR</li> </ul>
<b>Select Tools</b>		
	<b>Drag elements on selection</b>	<ul style="list-style-type: none"> <li>• <b>Ribbon:</b> All tabs&gt;Select panel</li> <li>• <b>Status Bar</b></li> </ul>
	<b>Filter</b>	<ul style="list-style-type: none"> <li>• <b>Ribbon:</b> <i>Modify</i>   <i>Multi-Select</i> tab&gt;Filter panel</li> <li>• <b>Status Bar</b></li> </ul>
	<b>Select Elements By Face</b>	<ul style="list-style-type: none"> <li>• <b>Ribbon:</b> All tabs&gt;Select panel</li> <li>• <b>Status Bar</b></li> </ul>
	<b>Select Links</b>	<ul style="list-style-type: none"> <li>• <b>Ribbon:</b> All tabs&gt;Select panel</li> <li>• <b>Status Bar</b></li> </ul>
	<b>Select Pinned Elements</b>	<ul style="list-style-type: none"> <li>• <b>Ribbon:</b> All tabs&gt;Select panel</li> <li>• <b>Status Bar</b></li> </ul>
	<b>Select Underlay Elements</b>	<ul style="list-style-type: none"> <li>• <b>Ribbon:</b> All tabs&gt;Select panel</li> <li>• <b>Status Bar</b></li> </ul>

