

Analysis of Machine Elements Using

SOLIDWORKS® Simulation 2021



Shahin S. Nudehi, Ph.D., P.E.
John R. Steffen, Ph.D., P.E.



Visit the following websites to learn more about this book:



[amazon.com](https://www.amazon.com)

[Google books](https://books.google.com)

[BARNES & NOBLE](https://www.barnesandnoble.com)

CHAPTER #2

CURVED BEAM ANALYSIS

This example, unlike that of the first chapter, will lead you quickly through those aspects of creating a finite element Study with which you already have experience. However, where new information or procedures are introduced, additional discussion is included. For consistency throughout this text, a common approach is used for the solution of all problems.

Learning Objectives

In addition to software capabilities studied in the previous chapter, upon completion of this example, users should be able to:

- Use SOLIDWORKS Simulation *icons* in addition to menu selections.
- Apply a *split line* to divide a selected face into one or more separate faces.
- Simulate *pin loading* inside a hole (or other loading on a curved surface).
- Use **Design Checks** to determine the *Factor of Safety* or lack thereof.
- Determine *reaction* forces acting on a finite element model.

Problem Statement

A dimensioned model of a curved beam is shown in Fig. 1; English units are used. Assume the beam is subject to a downward vertical force, $F_y = 3800$ lb, applied by a cylindrical pin (not shown) through a hole near its upper end. Beam material is 2014 Aluminum alloy. The bottom of the curved beam is considered “fixed.” In this context, the *actual* fixed end-condition is analogous to that at the end of a cantilever beam where translations in the X, Y, Z directions and rotations about the X, Y, Z axes are considered to be zero. However, recall from Chapter 1 that **Fixture** types within SOLIDWORKS Simulation also depend on the type of element to which they are applied. Therefore, because solid tetrahedral elements are used to model the curved beam, **Immovable** restraints are used.

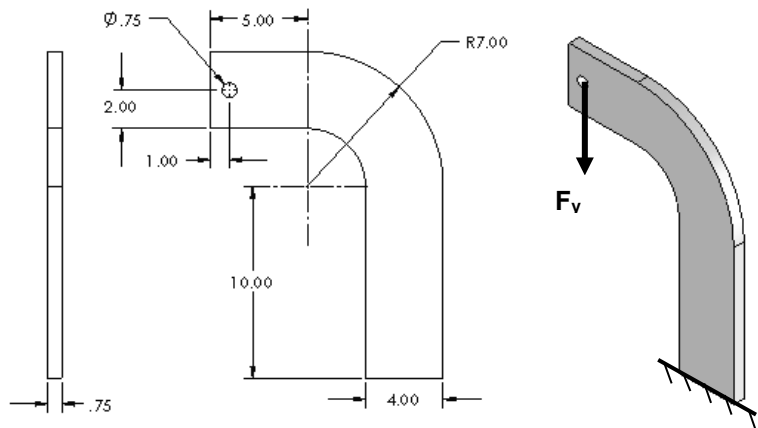

Figure 1 – Three dimensional model of a curved beam. (Dimensions in “inches”)

Design Insight

Numerous mechanical elements occur in the shape of initially curved beams. Examples include C-clamps, punch-press frames, crane hooks, and bicycle caliper brakes, to name a few. This example examines stress at section A-A shown in Fig. 2. For cases such as this, where applied load, F , acts to one side of the cross section under consideration, classical equations calculate bending moment $M = F \cdot L$ about the centroidal axis (not the neutral axis) at that location. Reaction force $R = F$ is also applied here. Accordingly, classical equations for stress in a curved beam can be used to predict stress at section A-A. In this example, the validity of this assumption is investigated while exploring additional capabilities of SOLIDWORKS Simulation software.

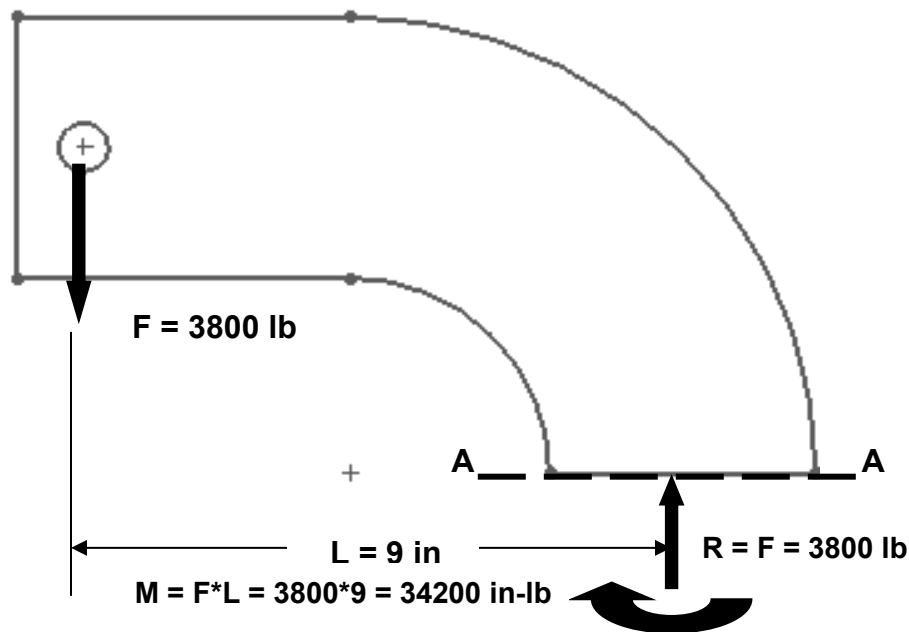

Figure 2 – Traditional free-body diagram of the upper portion of a curved beam model showing applied force F acting at a hole, and reactions $R = F$, and moment M acting on cut section A-A.

Creating a Static Analysis (Study)

1. Open SOLIDWORKS by making the following selections. (*NOTE*: The symbol “>” is used below to separate successive menu selections.)

Start>All Programs>SOLIDWORKS 2021 (or) Click the **SOLIDWORKS 2021** icon on your screen.

2. In the SOLIDWORKS main menu, select **File > Open...** Then browse to the location where SOLIDWORKS Simulation files are stored and select the file named “**Curved Beam,**” then click [**Open**].

Reminder:

If you do not see **Simulation** listed in the main menu of the SOLIDWORKS screen, click **Tools > Add-Ins...**, then in the **Add-Ins** window check **SOLIDWORKS Simulation** in both the **Active Add-Ins** and the **Start Up** columns, then click **[OK]**. This action permanently adds **Simulation** to the main menu every time a file is opened.

Because one goal of this chapter is to introduce and to use Simulation icons during the solution process, set-up of the Simulation toolbar is described below. If you previously set up the Simulation toolbar as outlined in the Introduction to this text, the Simulation *tab* should appear near the top left, above the graphics area on your screen. In that case, click on the **Simulation** *tab* and skip to step 5.

Setting up the Simulation Toolbar

If the **Simulation** *tab*, shown in Fig. 3, does not appear at the top left of your screen, then add it to the other tabs as follows. Otherwise, skip to step 2.

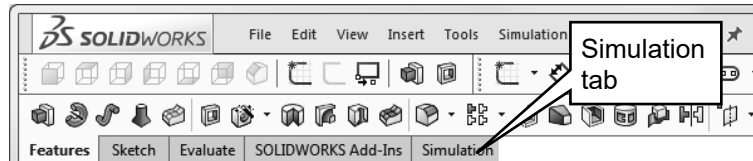

Figure 3 – Useful *tabs* located below the main menu.

1. Right-click on any of the *tab names* (**Features**, **Sketch**, **Evaluate**, etc.) and from the pull-down menu, click to place a check “✓” adjacent to **Simulation**. This action adds the **Simulation** *tab* beneath the main menu.
2. Click the **Simulation** *tab* and its associated toolbar, shown boxed in Fig. 4, opens.

This toolbar contains *either* the **Study**  icon or **Study Advisor**  icon. If other icons appear they will be “grayed out” until a Simulation Study is started.

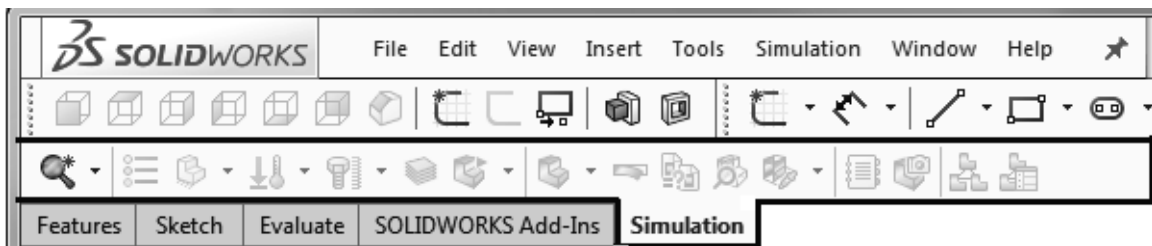

Figure 4 –Common icons found on the **Simulation** *tab*.

Presuming the **Simulation** icons to be unfamiliar to new users, the icon display mode illustrated in Fig. 6, which includes descriptive captions, is used throughout the remainder of this chapter. To display icons with captions, proceed as follows.

Analysis of Machine Elements Using SOLIDWORKS Simulation

3. Right-click anywhere on any toolbar at the top of the screen to open the **Command Manager** menu shown in a *partial* view in Fig. 5.
4. Just below **Command Manager** at top of this menu, click to select **Use Large Buttons with Text**. This action adds a brief description beneath each icon as shown in Fig. 6. NOTE: Icons shown in Fig. 6 will appear grayed out until a new Study is initiated in step 8 below.

*NOTE: It is also possible to right-click the **Simulation** tab, and from the pull-down menu select **Use Large Buttons with Text**.*

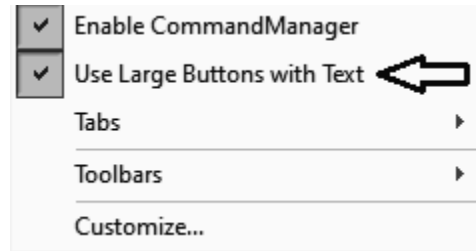

Figure 5 – Partial view of **Command Manager** pull-down menu.

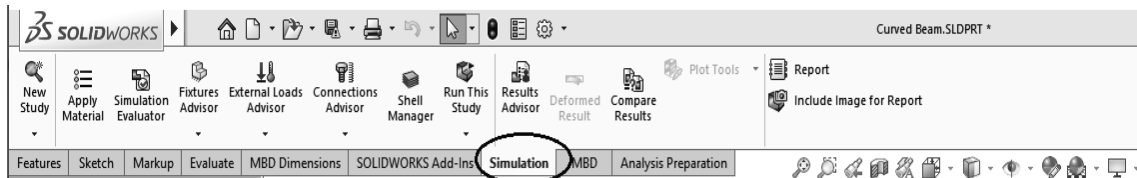

Figure 6 – View of the **Simulation** toolbar with descriptive captions applied beneath each icon.

5. In the **Simulation** tab begin a new study by selecting the ▼ symbol located on the **New Study** icon. From the pull-down menu select **New Study**. The **Study** property manager opens (not shown).
6. In the **Name** dialogue box, replace **Static 1** by typing **Curved Beam Analysis - YOUR NAME**. Including your name along with the Study name ensures that it is displayed on each plot. This helps identify results sent to public access printers.
7. In the **Type** dialogue box verify that **Static** is selected as the analysis type. Keep **Use 2D Simplification** unchecked.
8. Click **[OK]** ✓ (green check mark) to close the **Study** property manager.

Notice that an outline of the new Study is now listed beneath the Simulation manager tree and icons on the **Simulation** tab become active as shown in Fig. 6.

Now that an icon-based work environment is established, our Study of stress in the curved beam continues below. As in the previous example, the sequence of steps outlined in the Simulation manager, at the left of your screen, is followed from top to bottom as the current Study is developed.

Assign Material Properties to the Model

Part *material* is defined as outlined below.

1. On the **Simulation** *tab*, click to select the **Apply Material**  icon. The **Material** window opens as shown in Fig. 7.

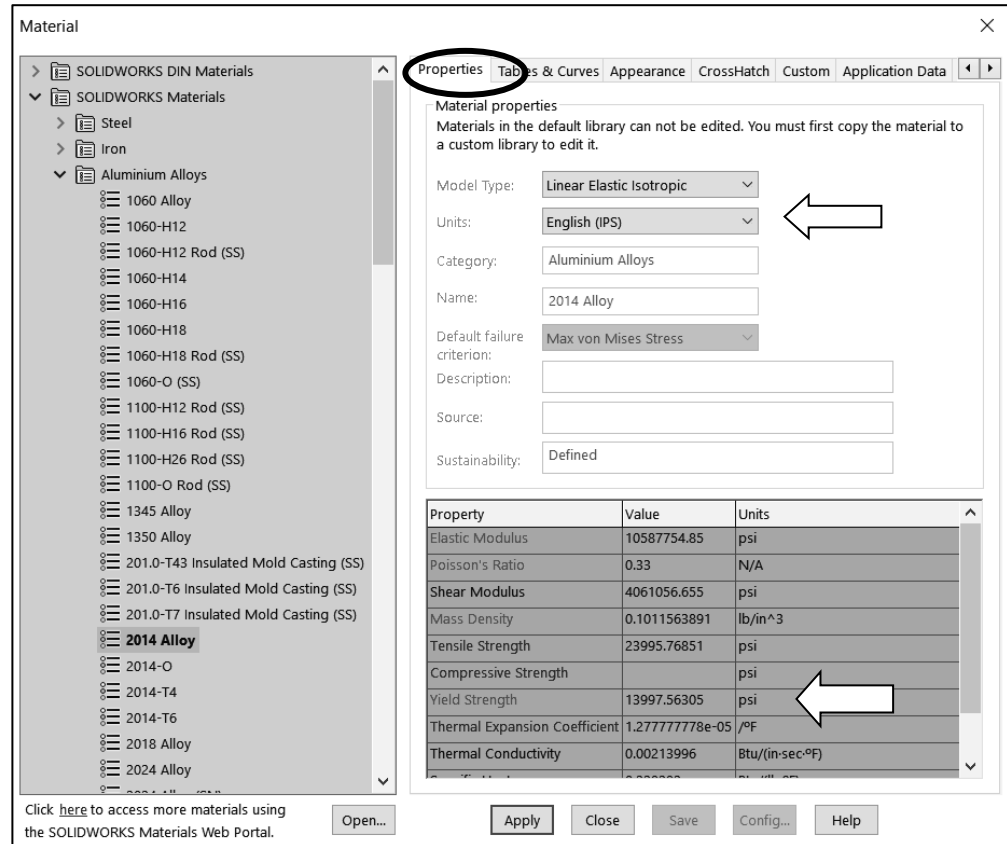





Figure 7 – Material properties are selected and/or defined in the **Material** window.

2. In the left column, select **SOLIDWORKS Materials** (if not already selected). Because the left column typically defaults to **Alloy Steel** or displays the last material selected, click the triangle  sign to close the **Steel** folder if necessary.
3. Next, click the triangle symbol next to **Aluminum Alloys** and scroll down to select **2014 Alloy**. The properties of 2014 Aluminum alloy are displayed on the **Properties** tab in the right half of the window.
4. In the **Properties** tab, click  to open the **Units:** pull-down menu and change **Units:** to **English (IPS)** if necessary.

In the table, note the material **Yield Strength** is a relatively low 13997.56 psi (essentially 14000 psi). Material with a low yield strength is intentionally chosen to facilitate discussion of *Factor of Safety* later in this example. Examine other values in the table to become familiar with data listed for each material.

Within the table, also notice that some material properties are indicated by red text, others by blue, and some by black. Red text indicates material properties that *must* be specified because a stress analysis is being performed. Conversely, material properties highlighted in blue text are optional values, while those listed in black primarily refer to thermal or vibration damping properties and, as such, are not needed for this stress analysis.

5. Click [**Apply**] followed by [**Close**] to close the **Material** window. A check mark “✓” appears on the **Curved Beam** folder to indicate a material has been selected. Also, the material type (**-2014 Alloy-**) is listed adjacent to the model name.
6. If the “**What would you like to do?**” window opens, click the question mark  icon at lower right of the graphics screen to close it.



Aside:

If at any point you wish to *change the material specification* of a part, such as during a redesign, simply right-click the name of the particular part whose material properties are to be changed and from the pull-down menu select **Apply/Edit Material...** The **Material** window opens and an alternative material can be selected.

However, be aware that when a different material is specified *after* running a solution, it is necessary to run the solution again using the revised material properties.

Applying Fixtures

For a static analysis, adequate restraints must be applied to stabilize the model. In this example, the bottom surface of the model is considered “fixed.”

1. On the **Simulation** tab, click ▼ beneath the **Fixtures Advisor**  icon, shown boxed in Fig. 8, and from the pull-down menu select **Fixed Geometry**. The **Fixture** manager opens as shown in Fig. 9.
2. Within the **Standard (Fixed Geometry)** dialogue box, select the  **Fixed Geometry** icon (if not already selected).
3. The **Faces, Edges, Vertices for Fixture** field is highlighted (light blue) to indicate it is active and waiting for the user to select part of the model to be restrained. Rotate and/or zoom to view the bottom of the model. Next, move the cursor over the model and when the bottom surface is indicated, click to select it. The surface is highlighted and fixture symbols appear as shown in Fig. 10. Also,

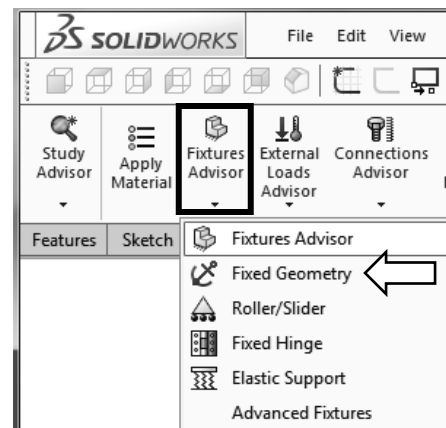

Figure 8 – Selecting the **Fixture** icon

Face<1> appears in the **Faces, Edges, Vertices for Fixture** field. If an incorrect entity (such as a vertex, edge, or the wrong surface) is selected, right-click the incorrect item in the highlighted field and from the pop-up menu select **Delete**; then repeat step 3.

4. If restraint symbols do not appear, or if it is desired to alter their size or color, click the down arrow ▼ to open the **Symbol Settings** dialogue box, at bottom of the **Fixture** property manager in Fig. 9, and check the **Show preview** box.
5. Both color and size of the restraint symbols (vectors in the X, Y, Z directions) can be changed by altering values in the **Symbol Settings** dialogue box of Fig. 9. Experiment by clicking the up ▲ or down ▼ arrows to change size of restraint symbols. A box of this type, where values can be changed either by typing a new value or by clicking the ▲ ▼ arrows, is called a “spin box.” Restraint symbols shown in Fig. 10 were arbitrarily increased in size to 200%.

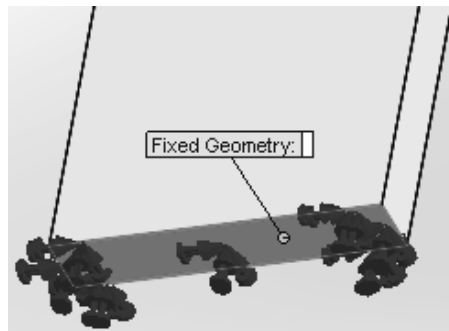

Figure 10 – **Fixtures** applied to bottom of the curved beam model

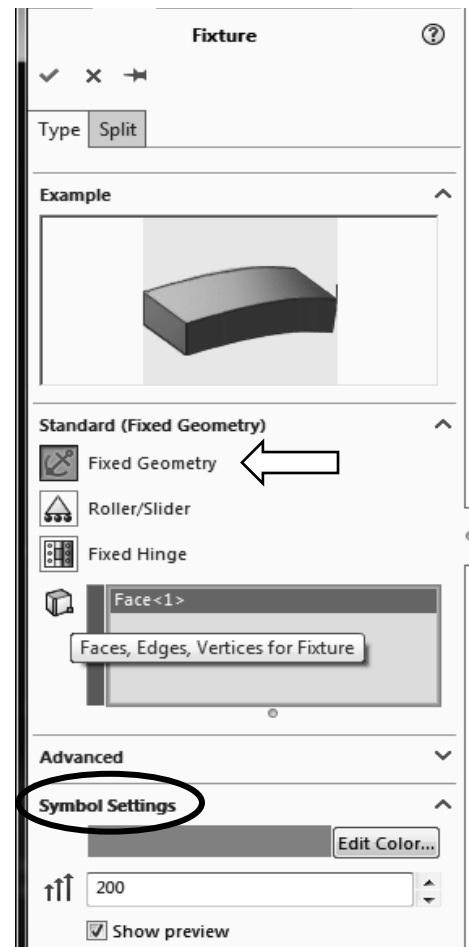



Figure 9 – **Fixture** property manager.

6. Click **[OK]** ✓ (green check mark) at top of the **Fixture** property manager to accept this restraint. An icon named  **Fixed-1** appears beneath the **Fixtures** folder in the Simulation manager tree. If the above **Fixed-1** icon does not appear, click the “▶” symbol adjacent to **Fixtures** in the Simulation manager tree.

Aside:

Restraint symbols shown in Fig. 10 appear as simple arrows with small disks on their tails. These symbols indicate **Fixed** restraints when applied to shell or beam elements. **Fixed** restraints set both *translational* and *rotational* degrees of freedom to zero (i.e., both X, Y, Z displacements and rotations (moments) about the X, Y, Z axes are zero). However, when applied to either solid models or truss elements, only *displacements* in the X, Y, and Z directions are restrained (i.e., prevented). This latter type of restraint is referred to as **Immovable**. The software applies appropriate fixtures based on element type. Watch for this subtle difference in future examples.

Applying External Load(s)

Next apply the downward force, $F_y = 3800$ lb, at the hole located near the top left-hand side of the model shown in Figs. 1 and 2. This force is assumed to be applied by a pin (not shown) that acts through the hole.

Analysis Insight:

Because the goal of this analysis is to focus on curved beam stresses at Section A-A, and because Section A-A is well removed from the point of load application, modeling of the applied force can be handled in a number of different ways. For example, the downward force could be applied to the vertical *surface* located on the upper left side of the model, Fig. (a). Alternatively, the force could be applied to the upper or lower *edge* of the model at the extreme left side, Fig. (b). These loading situations would require a slight reduction of the magnitude of force **F** to account for its additional distance from the left-side of the model to the centroidal axis at section A-A (i.e., the moment about section A-A must remain the same).

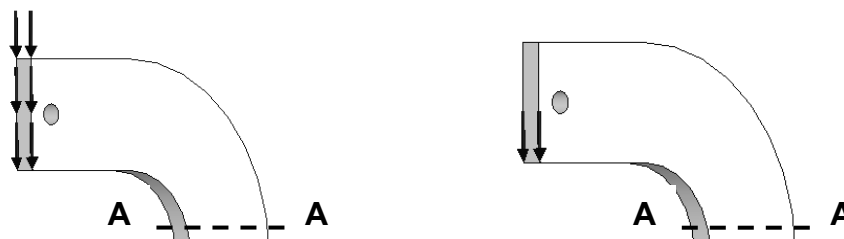

Figure (a) – Force applied to left surface.

Figure (b) – Force applied to lower edge.

The above loads are simple to apply. However, the assumption of pin loading allows us to investigate use of a *Split Line* to isolate a *portion* of the bottom surface of the hole where contact with a pin is assumed to occur. This surface is where a pin force would be transferred to the curved beam model. The actual contact area depends on a number of factors, which include (a) geometries of the contacting parts (i.e., relative diameters of the pin and hole), (b) material properties (i.e., hard versus soft contact surfaces of either the pin or the beam), and (c) magnitude of the force that presses the two surfaces together. This example arbitrarily assumes a reasonable contact area so that use of a *Split Line* can be demonstrated. If, on the other hand, contact stresses in the vicinity of the hole were of paramount importance, then determination of the true contact area

requires inclusion of the actual pin and use of *Contact/Gap* analysis. This type of analysis is investigated in Chapter #6.

Inserting Split Lines

The first task to simulate downward pin loading on the hole bottom is to isolate a small area at the bottom of the hole. This can be accomplished by using a *Split Line*. The method described below outlines use of a reference plane to insert a *Split Line*.

1. In the view toolbar, located above the graphics area, reorient the model by clicking the **Trimetric** or **Isometric** view icon.

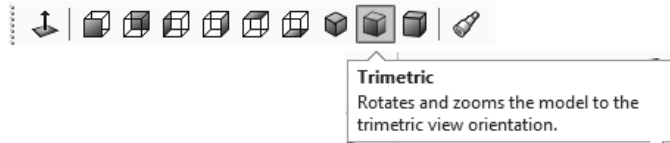

2. From the main menu, select **Insert**. Then, from succeeding pull-down menus make the following selections: **Reference Geometry** ► followed by **Plane...** In Fig. 11 the **Plane** property manager opens to the left of the graphics area. Also, a SOLIDWORKS “flyout” menu appears at the top left of the graphics area to provide access to SOLIDWORKS options; see label in Fig. 11.

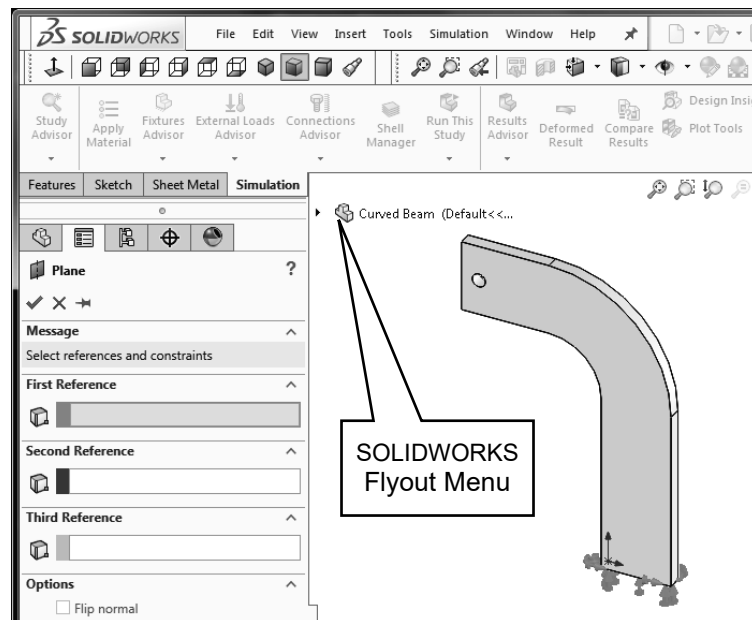

Figure 11 – The **Plane** property manager and SOLIDWORKS flyout menu.

3. Within the **Plane** property manager, under **First Reference**, the field is highlighted (light blue) to indicate it is active and awaiting selection of a plane from which a *new* plane can be referenced.

Analysis of Machine Elements Using SOLIDWORKS Simulation

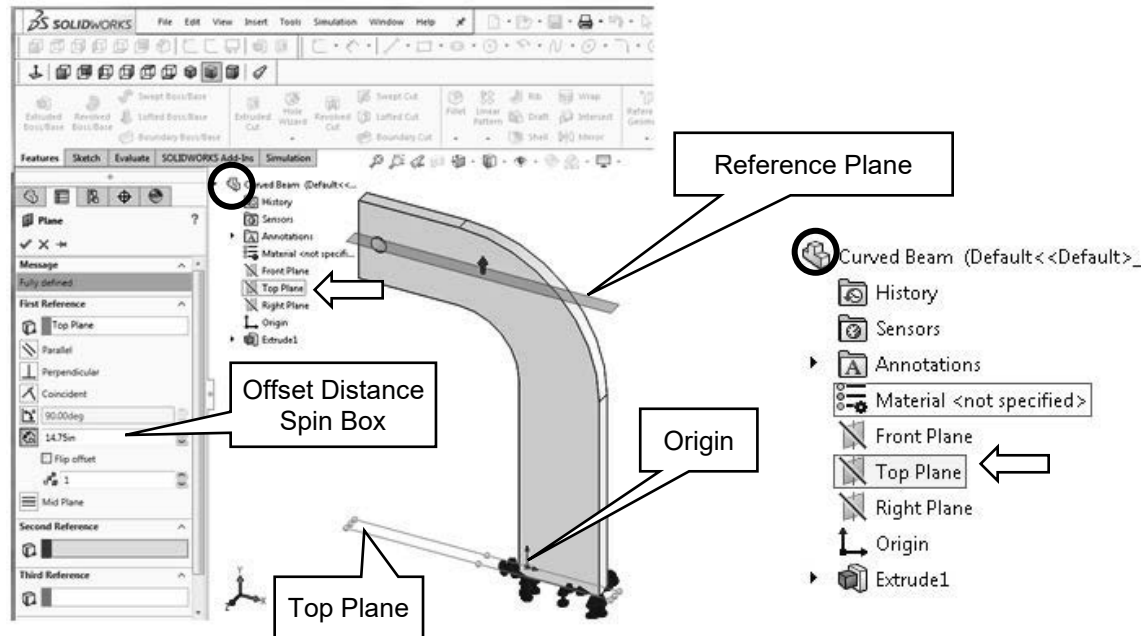

Figure 12 (a) - The **Plane** property manager and selections to create a reference plane passing through the bottom of the hole.

Fig. 12 (b) – Flyout menu (**enlarged view**).

- Begin by clicking the “▶” symbol to open the SOLIDWORKS flyout menu circled in Figs. 12(a) and (b). Within the flyout menu select the **Top Plane**; see arrows. The **Plane** property manager changes appearance as shown in Fig. 12(a), and **Top Plane** appears in the **First Reference** dialogue box. For those using the **Curved Beam** part file from the textbook web site, the top plane passes through the part origin, which is located on the bottom of the model¹ in Fig. 12 (a).
- Return to the **First Reference** dialogue box and in the **Offset Distance** spin-box and type **14.75**. This is the distance *from* the **Top Plane** to a **Reference Plane** located so that it intersects the bottom portion of the hole in Fig. 12 (a).

Aside:

The 14.75-in. dimension is determined from the following calculation. Refer to Fig. 1 to determine the source of values used in the equation below.

$$10 \text{ in (height of straight vertical sides)} + 3 \text{ in (radius of concave surface)} + 1.75 \text{ in (distance from the horizontal edge beneath the hole and extending an arbitrary distance into the bottom portion of the hole)} = 14.75 \text{ in.}$$

It is emphasized that the area intersected on the bottom of the hole is chosen *arbitrarily* in this example!

¹ Users who created a curved beam model from scratch can also follow these instructions. The *only* difference would be specification of the proper *distance* from the **Top Plane** (used as a reference in *your* model) to the bottom of the hole.

- Click **[OK]** ✓ to close the **Plane** property manager.

The reference plane created in the previous steps appears highlighted on your screen. If your model is large enough it will be labeled **Plane1**, if not, zoom-in on the top of the model. In the following steps **Plane1** is used to create *Split Lines* near the bottom of the hole. These *Split Lines* enable us to define a small “patch” of area on the bottom of the hole where the downward load will be applied.

- From the **Main Menu**, select **Insert**. Then, from successive pull-down menus, choose **Curve** ► followed by **Split Line...** The **Split Line** property manager opens as shown in Fig. 13.
- Beneath **Type of Split**, select **Intersection**. This choice designates the means by which *Split Lines* are defined for this example (i.e., *Split Lines* will be located where the reference plane *intersects* the hole).
- In the **Selections** dialogue box, **Plane1** should already appear in the **Splitting Bodies/Faces/Planes** field. If **Plane1** does not appear in this field, click to activate the field (light blue), then move the cursor onto the graphics screen and select the upper plane when it is highlighted. **Plane1** now appears in the top field.

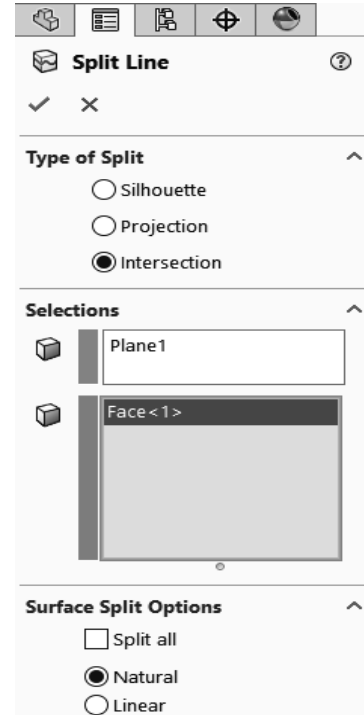

Figure 13 – **Split Line** property manager showing selections.

- Next, click inside the **Faces/Bodies to Split** field. This field may already be active (light blue). Then move the cursor over the model and select anywhere on the *inside surface* of the hole. It may be necessary to zoom in on the model to select this surface. Once selected, **Face<1>** appears in the active field. Figure 14 shows a partial image of the model with *Split Lines* appearing where **Plane1** intersects the bottom portion of the hole.

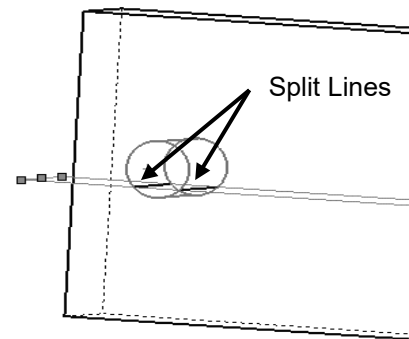

Figure 14 – Close-up view of hole showing *Split Lines* where **Plane1** intersects near the bottom of hole.



Remain zoomed-in on the model to facilitate applying a force to the inside of the hole.

- In the **Surface Split Options** dialogue box, select **Natural**. A **Natural** split follows the contour of the selected surface.

12. Click **[OK]** ✓ to close the **Split Line** property manager.
13. If an information “flag” appears adjacent to the *Split Lines*, click ☒ to close it.

Applying Force to an Area Bounded by Split Lines

Now that a restricted area on the bottom of the hole has been identified, the next step is to apply a downward force, $F_y = 3800$ lb, on this area. Proceed as follows.

1. On the Simulation *tab*, click ▼ beneath the **External Loads Advisor**  icon and from the pop-up menu select the  **Force** icon. The **Force/Torque** property manager opens and appears in a partial view in Fig. 15.
2. Within the **Force/Torque** dialogue box, click the  **Force** icon (if not already selected). Also, click **Selected direction**. Then click to activate (light blue) the upper field titled **Faces, Edges, Vertices, Reference Points for Force**.
3. Move the cursor over the model and when the *bottom inside surface* of the hole is outlined, click to select it. **Face<1>** appears in the active field of the **Force/Torque** dialogue box.
4. Next, click to activate the second field from the top of the **Force/Torque** dialogue box. Passing the cursor over this field identifies it as the **Face, Edge, Plane for Direction** field. This field is used to specify the direction of the force applied to the bottom of the hole.

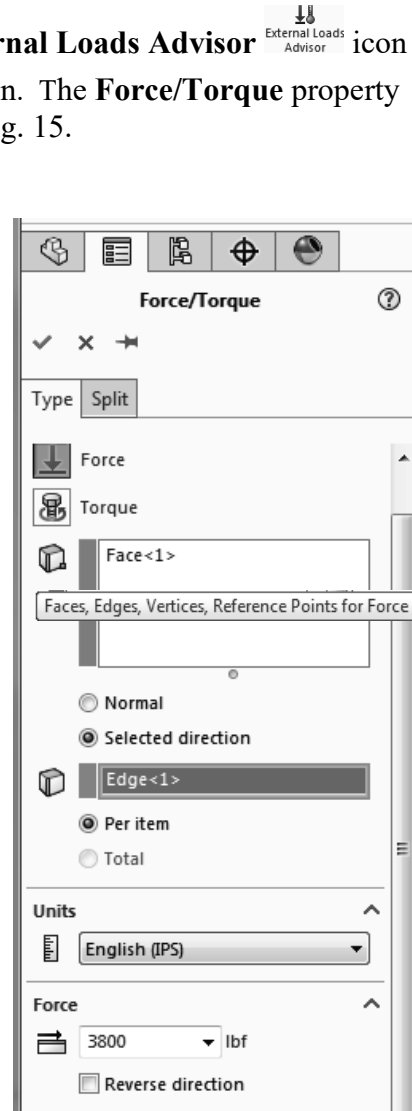



Figure 15 – Specifying a force and its direction on the hole bottom.

Because a downward, vertical force is to be applied, select a *vertical edge . . . any vertical edge . . .* on the model aligned with the Y-direction. After selecting a vertical edge, **Edge<1>** appears in the active field and force vectors appear on the model as seen in Fig. 16.

5. In the **Units** dialogue box, set **Units**  to **English (IPS)** (if not already selected).
6. In the **Force** dialogue box, type **3800**. As noted in an earlier example, it may be necessary to check **Reverse Direction** if the force is not directed downward.

- Click **[OK]** ✓ to accept this force definition and close the **Force/Torque** property manager. An icon named **Force-1 (:Per item: 3800 lbf:)** appears beneath the **External Loads** folder in Simulation manager.

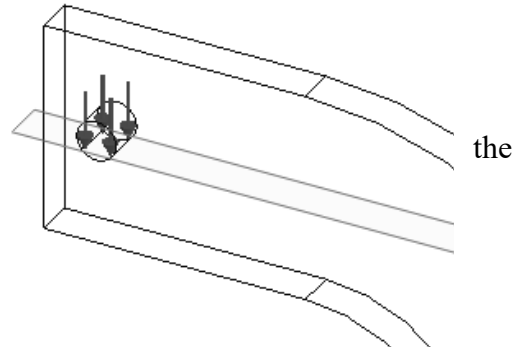





Figure 16 – Downward force applied between *Split Lines* on bottom of hole. A wireframe view of the model is shown.

The model is now complete as far as material, fixtures, and external load definitions are concerned. The next step is to Mesh the model as described below.

Meshing the Model

- Within the Simulation *tab*, select ▼ beneath

the **Run this Study**  icon. From the pull-down menu, select the  **Create Mesh** icon. The **Mesh** property manager opens as shown in Figs 17 (a) and (b).

- Check ✓ to open the **Mesh Parameters** dialogue box and verify that a **Standard mesh** is selected. Also set the **Unit**  field to **in** (if not already selected). Accept the remaining default settings (i.e., mesh **Global Size** and **Tolerance**) shown in this dialogue box.
- Click the down arrow ▼ to open the **Advanced** dialogue box, Fig. 17 (b). Verify that **Jacobian points** is set at **4 points** (this setting indicates high quality tetrahedral elements are used). These default settings produce a good quality mesh. However, verify that the settings are as listed and only change them if they differ.

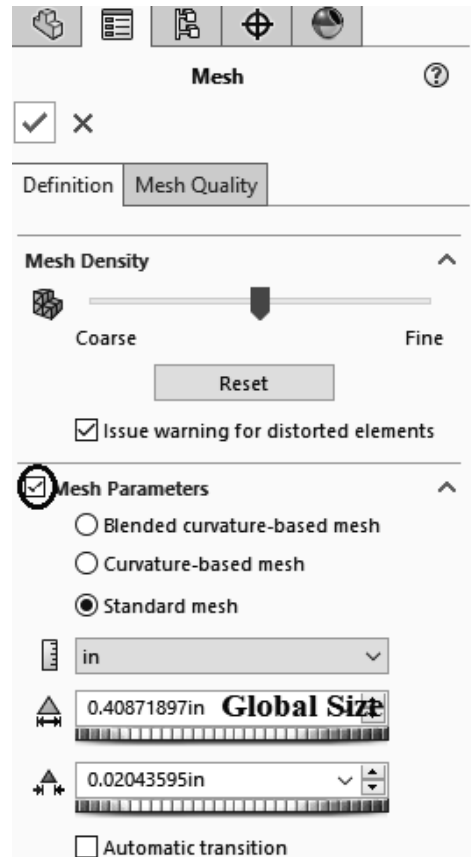

Figure 17 (a) – **Mesh** property manager showing system default **Mesh** settings applied to the current model.

4. Finally, click **[OK]** ✓ to accept the default mesh settings and close the **Mesh** property manager.

Meshing starts automatically and a **Mesh Progress** window appears briefly. After meshing is complete, SOLIDWORKS Simulation displays the meshed model shown in Fig. 18. Also, a check mark “✓” appears on the **Mesh** icon to indicate meshing is complete.

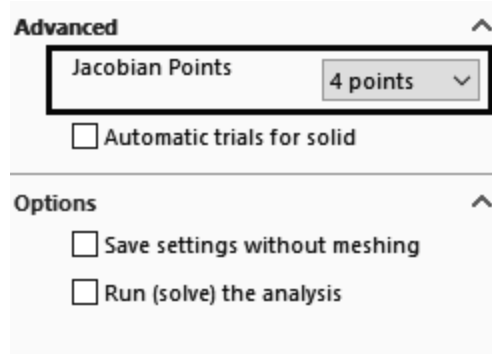



Figure 17 (b) – Views of the **Advanced** and **Options** portions of the **Mesh** property manager.

Since **Plane1** is no longer needed, hide the reference plane by right-clicking it and, from the pop-up menu, select the  **Hide** icon.

OPTIONAL:

5. Display mesh information by right-clicking the  **Mesh** folder located in the Simulation manager tree (not the Create Mesh icon); then select **Details...**

The **Mesh Details** window displays a variety of mesh information. Scroll down the list and note the number of nodes and elements for this model is 12578 nodes and 7229 elements (numbers may vary slightly due to the automated mesh generation procedure).

Rotate the model as illustrated in Fig. 18 (a Trimetric view) and notice that the mesh is two elements *thick*. Two elements across the model’s thinnest dimension are considered the minimum number for which *Solid Elements* should be used. Thus, two elements are considered an unofficial dividing line between when *Shell* or *Solid Elements* should be used. Therefore, either element type could be used for this model. But, keep in mind that shell elements are typically reserved for thin parts.

6. Click  to close the **Mesh Details** window.

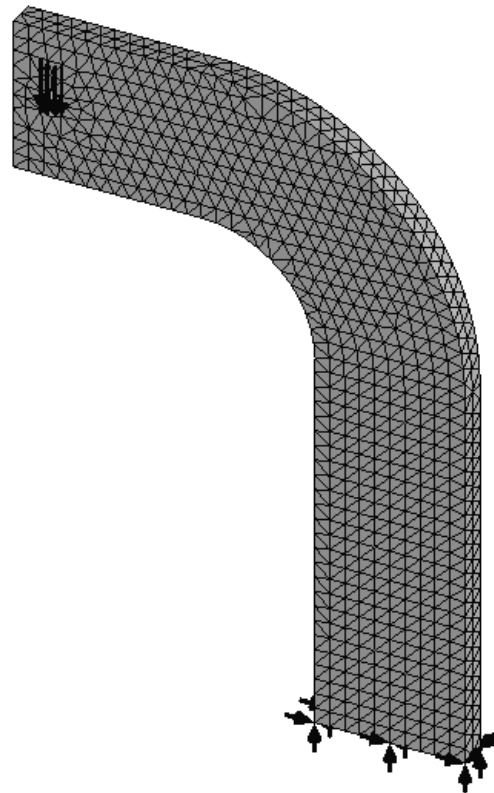

Figure 18 – Curved beam with mesh and boundary conditions illustrated.

Reminder

Recall that it is permissible to define material properties, fixtures, external loads, and create the mesh in any order. However, all these necessary steps must be completed before running a solution.

Solution

After the model has been completely defined, the solution process is initiated. During a solution the numerous equations defining a Study are solved and results of the analysis are automatically saved for review.

1. On the **Simulation** tab, click the **Run this Study** icon to start the Solution.

After a successful solution, a **Results** folder appears below the Simulation manager. This folder should include three default plots saved at the conclusion of each Study. These folders are named as illustrated in Fig. 19. If these folders do *not* appear, follow steps (a) through (f) outlined on page 1-14 of Chapter #1.

If **Units** displayed on the **Stress1 (-vonMises-)** and **Displacement1 (-Res disp-)** plots are not **psi** and **in** respectively, then change them as outlined in steps 2 through 5 below. Otherwise, skip to the next section.

2. If the von Mises stress plot is not shown, double-click **Stress1 (-vonMises-)** to display the plot.
3. Next, right-click **Stress1 (-vonMises-)** and from the pull-down menu select **Edit Definition...** The **Stress Plot** property manager opens. In the **Display** dialogue box, verify **Units** are set to **psi**. If not, use the pull-down menu to change **Units**.

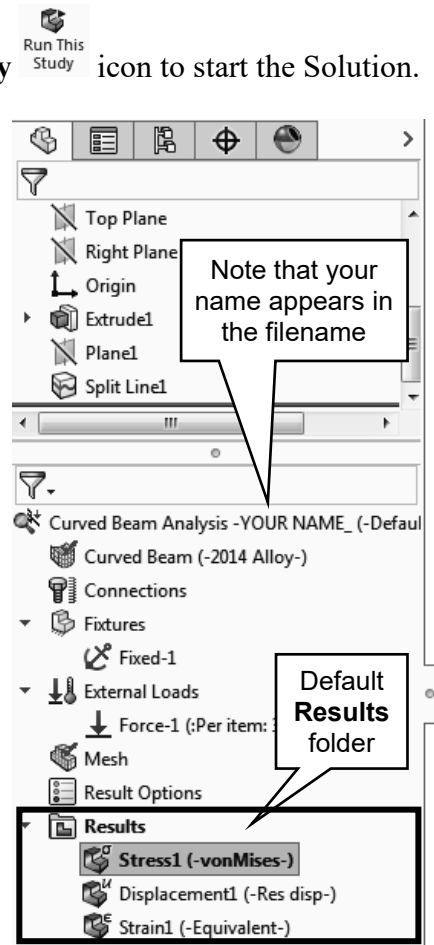

Figure 19 – **Results** folders created during the Solution process.

4. Click **[OK]** ✓ to close the **Stress Plot** property manager.
5. Repeat steps (2) through (4); however, in step (2), double-click **Displacement1 (-Res disp-)** and in step (3) in the **Display** dialogue box alter the **Units** field from **mm** to **in**. NOTE: **Res disp** is short for “resultant displacement.”

Examination of Results

Analysis of von Mises Stresses Within the Model

Outcomes of the current analysis can be viewed by accessing plots stored in the **Results** folders listed in the previous section. This step is where validity of results is verified by cross-checking Finite Element Analysis (FEA) results against results obtained using classical stress equations or by experiment. *Checking results is a necessary step in good engineering practice!*

1. In the Simulation manager tree, double-click the **Stress1 (-vonMises-)** folder (or right-click it and from the pull-down menu, select **Show**). A plot of the von Mises stress distribution throughout the model is displayed.

Figure 20 reveals an image *similar* to what currently appears on the screen. SOLIDWORKS Simulation has a feature that combines all **Results** display options into a single property manager. Access to those display options is accessible via three *tabs* at top of the **Stress Plot** property manager. We will use those tabs in the following steps to convert your current screen image to that shown in Fig. 20.

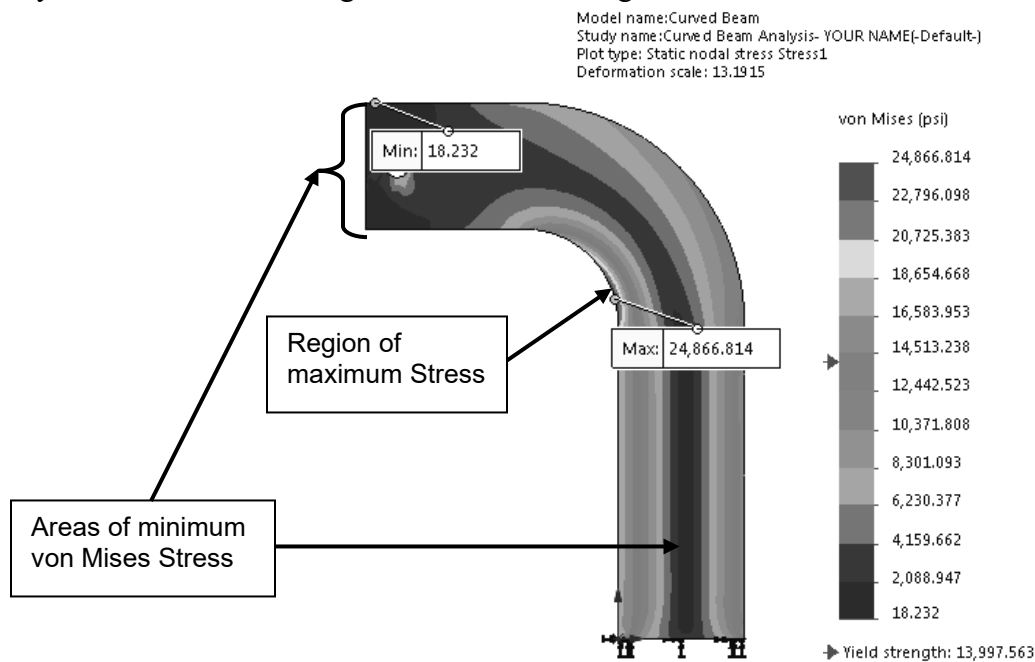

Figure 20 – Front view of the curved beam model showing von Mises stress *after* making changes outlined below. Note arrows indicating Yield Strength on the stress scale at right.

NOTE: *Stress contour plots are printed in black, white, and grey tones. Therefore, light and dark color areas on your screen may appear different from images shown throughout this text.*

- Right-click **Stress1 (-vonMises-)** and from the pull-down menu select **Chart Options...** The **Stress Plot** property manager opens, a *portion* of which is shown in Fig. 21. Note that the **Chart Options** tab is selected.

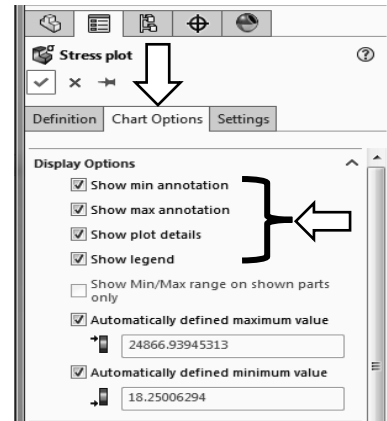

Figure 21 – Upper portion of **Chart Options** tab showing current selections.

- Within the **Display Options** dialogue box, click to place check marks “✓” to activate **Show min annotation** and **Show max annotation**. This action labels minimum and maximum von Mises stress locations and magnitudes on the model. *Do not change other checked items.*
- Within the **Position/Format** dialogue box, change the **Number Format** from **scientific** to **floating** from the pull-down menu. Type **3** for **No of Decimals**.

- Next, select the **Settings** tab. A partial view of this tab is illustrated in Fig. 22.
- In the **Fringe Options** dialogue box, open ▼ the pull-down menu and select **Discrete** as the fringe type to be displayed.
- Next, in the **Boundary Options** dialogue box, select **Model** from the pull-down menu to superimpose a solid outline on the model.
- Click **[OK]** ✓ to close the **Stress Plot** property manager. If the above changes are not displayed, on the model, double-click **Stress1 (-vonMises-)**.

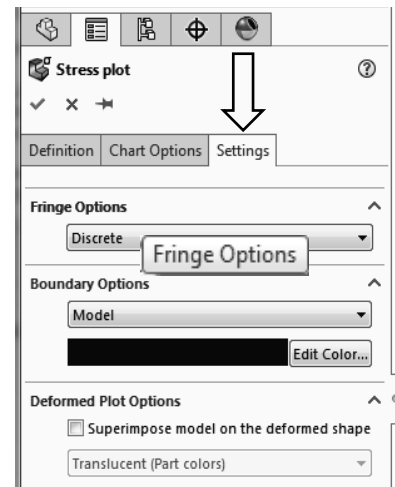

Figure 22 – Selections in the **Stress Plot** property manager.

- On the **Simulation** tab, repeatedly click the **Deformed Result** icon to toggle between a deformed image of the model (default state) and an un-deformed image. See images in Fig. 23 (a) and (b). When done, leave the model in the un-deformed state and rotate it to a front view.

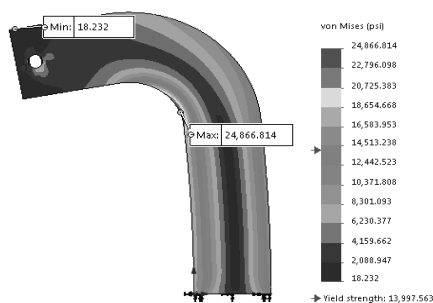

Figure 23 (a) – Deformed model image.

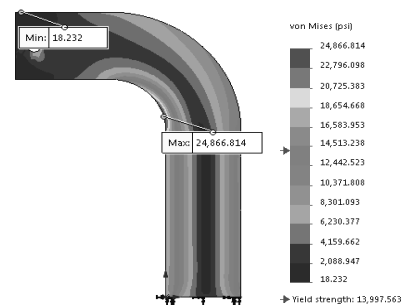

Figure 23 (b) - Un-deformed model image.

The following observations can be made about the figure currently on your screen.

OBSERVATIONS:

- Areas of low stress (dark blue) occur at the top-left side of the model and also through the vertical center of the model. This last region overlaps the neutral axis. The minimum von Mises stress is approximately 18. psi. Regions of high stress are indicated in red. The maximum stress indicated is 24867.6 psi, which occurs along the concave surface (values may vary slightly).
- Material *Yield Strength* = 13997.6 \approx 14000 psi is also listed beneath the color-coded **von Mises** stress legend. A red arrow adjacent to the color chart indicates where the Yield Strength lies relative to all stresses within the model. In this instance, it is clear that some stress in the model *exceeds* the material yield strength. *Yield Strength* and *Safety Factor* are investigated later in this chapter.

Modern software makes conducting a finite element analysis and obtaining results deceptively easy. As noted earlier, however, it is the validity of results and understanding how to interpret and evaluate them properly that is of primary importance. For these reasons, we pause to consider two questions that should be intriguing or, perhaps, even bothering you, the reader.

First, why are all stress values positive in Fig. 20? (“+” stress values typically indicate tension). However, compressive stresses are known to exist along the concave surface for the given loading. Second, why does the solution show stresses above the material yield strength when stresses that exceed the yield strength indicate yielding or failure? These, and many others, are the types of questions that should be raised continually by users of finite element software. Attempts to address these questions are included below.

To answer these questions, we briefly digress to investigate the definition of von Mises stress as a means to determine a *Safety Factor* predicted by the software.

Von Mises Stress -

The example of Chapter 1 avoided the issue about what the von Mises stress is or what it represents. That example further assumed that some readers might not be familiar with von Mises stress. For the sake of completeness and because von Mises stress typically is not introduced until later in a design of machine elements course, its basic definition is included below. Although this SOLIDWORKS Simulation user guide is not intended to develop the complete theory related to von Mises stress, the usefulness of this stress might be summed up by the following statement:

The equation for von Mises stress “allows the most complicated stress situation to be represented by a single quantity.”² In other words, for the most complex state of stress that one can imagine (e.g., a three-dimensional stress element subject to a

² Budynas, R.G., Nisbett, J. K., Shigley’s Mechanical Engineering Design, 9th Ed., McGraw-Hill, 2010, p.224.

combination of shear and normal stresses acting on every face, as illustrated below), these stresses can be reduced to a single number. That number is named the von Mises stress. This number represents a stress magnitude, “which can be compared against the yield strength of a material”³ to determine whether or not failure by yielding is predicted. As such, the von Mises stress is associated with one of the theories of failure for *ductile* materials; theories of failure are briefly discussed below. Von Mises stress is always a *positive, scalar* number.

The above statement answers the question about the positive nature of von Mises stress shown on the model in Fig. 20 and on your screen. It also should provide some insight into why von Mises stress, which is a *single number*, can be used to determine whether or not a part is likely to fail by comparing it to the value of part yield strength (*yield strength is also listed as a single value*). The method of comparison used is the *Safety Factor*, which is explored later in this chapter.

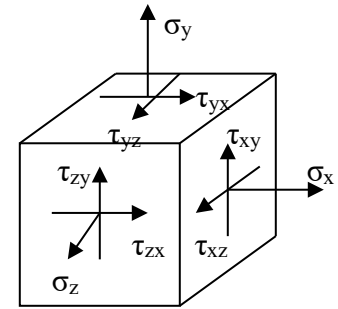

Although the above definition indicates that von Mises stress is always a positive number, that superficial answer might continue to bother readers who intuitively recognize that compressive stresses result along the concave surface of the curved beam.

More fundamentally the issue in question gets to the heart of every analysis. That question is, “*What stress should be examined* when comparing finite element results with stress calculations based on the use of classical equations?” The answer, of course, is that one must examine the *appropriate stresses* that correspond to the goals of an analysis. For example, in Chapter 1 it was decided that normal stress in the Y-direction (σ_y) was the primary stress component that would provide favorable comparisons with stress calculated using classic equations. The **Verification of Results** section below reveals the *appropriate stress* for the current example. Before continuing, answer the question: “*What is the appropriate stress?*” Then, check your answer below.

Verification of Results

In keeping with the philosophy that it is *always* necessary to verify the validity of Finite Element Analysis (FEA) results, a quick comparison of FEA results with those calculated using classical stress equations for a curved beam is included below.

Results Predicted by Classical Stress Equations

Although not all users may be familiar with the equations for stress in a curved beam, the analysis below should provide sufficient detail to enable reasonable understanding of this state of stress. The first observation is a somewhat unique characteristic of curved beams, namely, for a symmetrical cross-section the beam neutral axis lies closer to the center of curvature than does its centroidal axis. These axes can be observed in Fig. 24. By definition the centroidal axis, identified as r_c , is located half-way between the inside and outside radii of curvature. However, the neutral axis, identified by r_n , lies closer to

³ Ibid

the inside (concave) surface. Based on this observation, a free body diagram of the upper portion of the curved beam is shown in Fig. 24. Included on this figure are important dimensions used in the following calculations. Dimensions shown are defined below.

w = width of beam cross-section = 4.00 in (see Fig. 1) **or** $r_o - r_i = 7.00 - 3.00 = 4.00$ in

d = depth (thickness) of beam cross-section = 0.75 in (see Fig. 1)

A = cross-sectional area of beam = $w \cdot d = (0.75 \text{ in})(4.00 \text{ in}) = 3.00 \text{ in}^2$

r_i = radius to inside (concave surface) = 3.00 in

r_o = radius to outside (convex surface) = $r_i + w = 3.00 + 4.00 \text{ in} = 7.00 \text{ in}$

r_c = radius to centroid of beam = $r_i + w/2 = 3.00 + 4.00/2 = 5.00 \text{ in}$

r_n = radius to the neutral axis = $w/\ln(r_o/r_i) = 4.00/\ln(7.00/3.00) = 4.72 \text{ in}$. [determined by equation for a curved beam having a rectangular cross-section]

c_i = distance from the neutral axis to the inside surface = $r_n - r_i = 4.72 - 3.00 = 1.72 \text{ in}$

c_o = distance from the neutral axis to the outside surface = $r_o - r_n = 7.00 - 4.72 = 2.28 \text{ in}$

e = distance between the centroidal axis and neutral axis = $r_c - r_n = 5.00 - 4.72 = 0.28 \text{ in}$

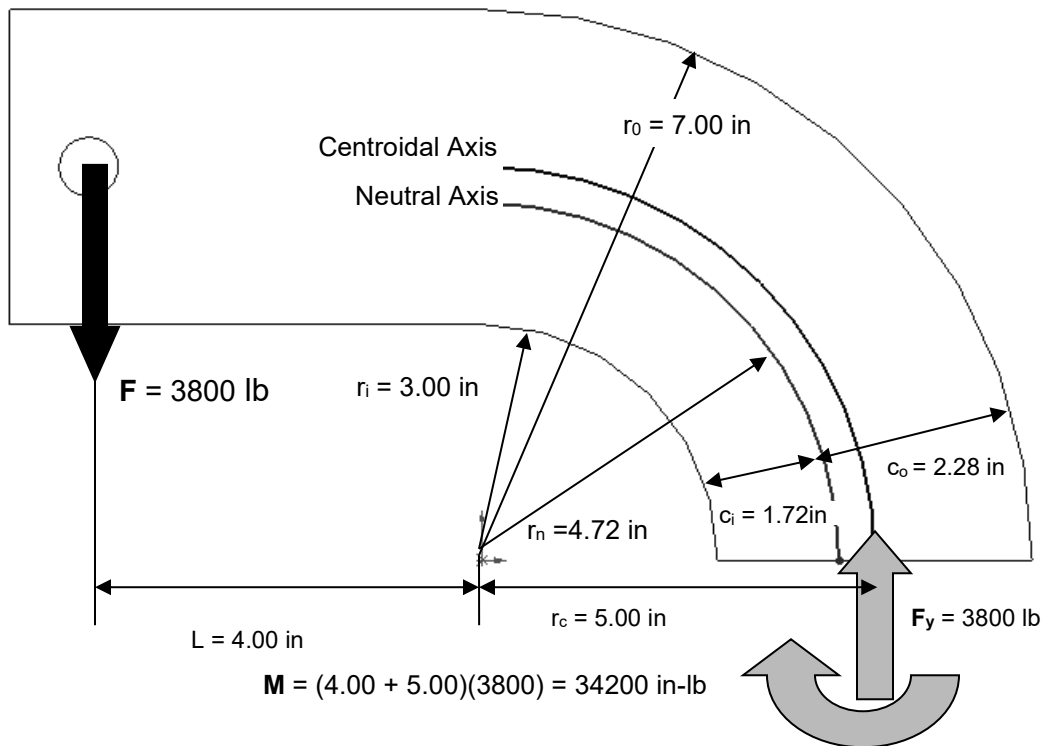

Figure 24 – Geometry associated with calculation of stress in a curved beam.

The reaction force F_y and moment M acting on the cut section are necessary to maintain equilibrium of the upper portion of the curved beam. Equations used to compute the combined bending and axial stresses that result from these reactions are included below. Each equation is of the general form,

$$\text{Curved beam stress} = \pm \text{ bending stress} \pm \text{ axial stress}$$

Where the “ \pm ” sign for bending stress depends on what side of the model is being investigated. In this case, bending stress caused by moment M is compressive on the concave surface of the curved beam. Hence a minus “-” sign is assigned to the bending

stress term in equation [1]. However, on the convex side, bending stress causes tension on the beam surface, thereby accounting for a “+” sign associated with the first term in equation [2]. Reaction force F_y acts to produce a compressive stress on the cut section. Therefore, a minus “-” sign is used with the axial stress component in both equations [1] and [2] below. In what *direction* do both of these stresses act?

Stress at the inside (concave) surface:



$$\sigma_i = \frac{Mc_i}{Ae r_i} - \frac{F_y}{A} = \frac{-(34200 \text{ in-lb})(1.72 \text{ in})}{(3.00 \text{ in}^2)(0.28 \text{ in})(3.00 \text{ in})} - \frac{3800 \text{ lb}}{3.00 \text{ in}^2} = -24610 \text{ psi} \quad [1]$$

Stress at the outside (convex) surface:

$$\sigma_o = \frac{Mc_o}{Ae r_o} - \frac{F_y}{A} = \frac{(34200 \text{ in-lb})(2.28 \text{ in})}{(3.00 \text{ in}^2)(0.28 \text{ in})(7.00 \text{ in})} - \frac{3800 \text{ lb}}{3.00 \text{ in}^2} = 11990 \text{ psi} \quad [2]$$

Comparison with Finite Element Results

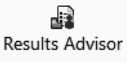
In addition to serving as a quick check of results, this section reviews use of the **Probe** tool. Both bending and axial stresses act normal to the cut surface in Fig. 24. Therefore, the *appropriate* stress to be used for the finite element analysis is stress acting in the Y-direction. Thus, σ_y should be compared with values computed using equations [1] and [2] above. You are encouraged to produce a finite element plot of stress σ_y on your own. However, abbreviated steps are outlined below if guidance is desired.

1. In the **Simulation** tab, click  on the **Results Advisor**  icon and from the pull-down menu select **New Plot**. Then from the next pull-down menu select the  **Stress** icon. The **Stress plot** property manager opens.
2. In the **Display** dialogue box, select **SY: Y Normal Stress** from the pull-down menu. Also in the **Display** dialogue box, set the **Units**  field to display **psi**.
3. Click to clear the check “✓” mark from the **Deformed Shape** dialogue box.
4. Next, within the **Stress plot** property manager, select the **Chart Options** *tab*.
5. In the **Display Options** dialogue box check “✓” to select **Show min annotation** and also **Show max annotation**. This action labels both maximum and minimum stress values on the plot of **SY: Y Normal Stress**. Also, within the **Position/Format** dialogue box, change the **Number Format** from **scientific** to **floating** from the pull-down menu.
6. Finally, in the **Stress plot** property manager, select the **Settings** *tab*.
7. Within the **Settings** *tab*, change the **Fringe Options** pull-down menu to **Discrete**.
8. Click **[OK]** ✓ to close the **Stress plot** property manager.

If a plot of **SY: Y Normal Stress** like that in Fig. 25 does not appear, right-click **Stress2 (-Y Normal-)** and from the pull-down menu select **Show**.

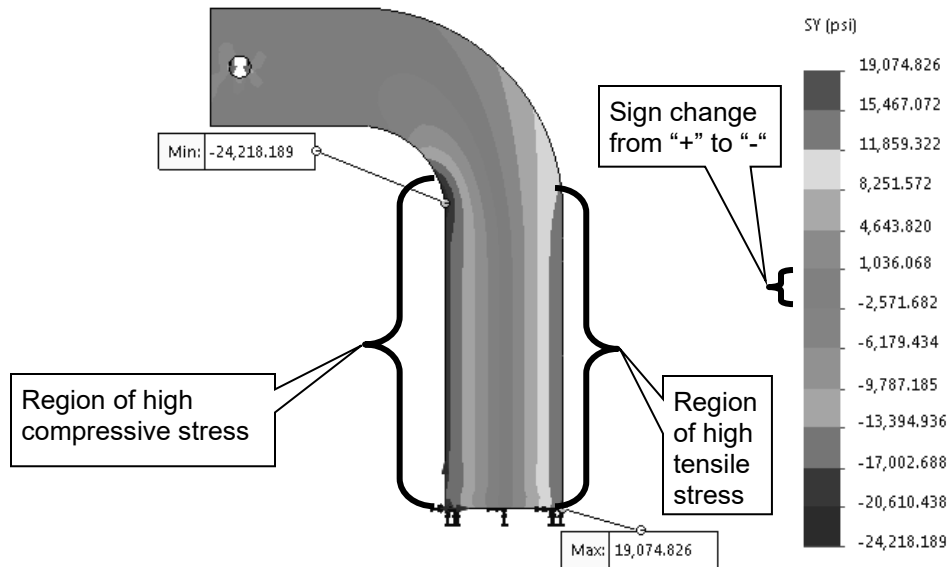

Figure 25 – Plot of **SY: Y Normal Stress** (σ_y) on the curved beam model.

The following observations can be made about Fig. 25.

OBSERVATIONS:

- Tensile (i.e., positive “+”) stress is shown in lime green, yellow, orange, and red. This stress occurs primarily along the right vertical side and convex region of the model. Because this region is subject to tensile stress, positive “+” stress magnitudes are expected.
- Compressive (i.e., negative “-”) stress is shown by some green, light blue, and dark blue located along the left vertical and concave region of the model. Once again compressive stress should correspond with the user’s intuitive sense of stress in that region. Although labeled **Min**, compressive stress is algebraically larger than the maximum tensile stress.
- Low stress regions, corresponding to the neutral axis, or neutral plane, run near the vertical center of the model. Notice the sign change from “+” to “-” in the light green color coded region of the stress chart. Recall for beams in bending, zero stress occurs on the neutral axis (or) neutral plane.
- Note that **Yield Strength** is *only* labeled on the vonMises stress plot. It does not appear on the current plot. Also, **min** and **max** stress locations are labeled.

The model is next prepared to examine stresses at section **A_i-A_o** shown in Fig. 26.

9. Right-click **Stress2 (-Y Normal-)**, and from the pull-down menu, select **Settings**. Within the **Stress plot** property manager, and set the **Boundary Options** pull-down menu to ▼ **Mesh**. A mesh is displayed on the model.

10. Click **[OK]** ✓ to close the **Stress plot** property manager.
11. Zoom in on the model to where the curved beam section is tangent to the straight, vertical section, shown as **A_i** and **A_o** in Fig. 26, where subscripts “**i**” and “**o**” refer to the inside and outside surfaces of the model respectively.

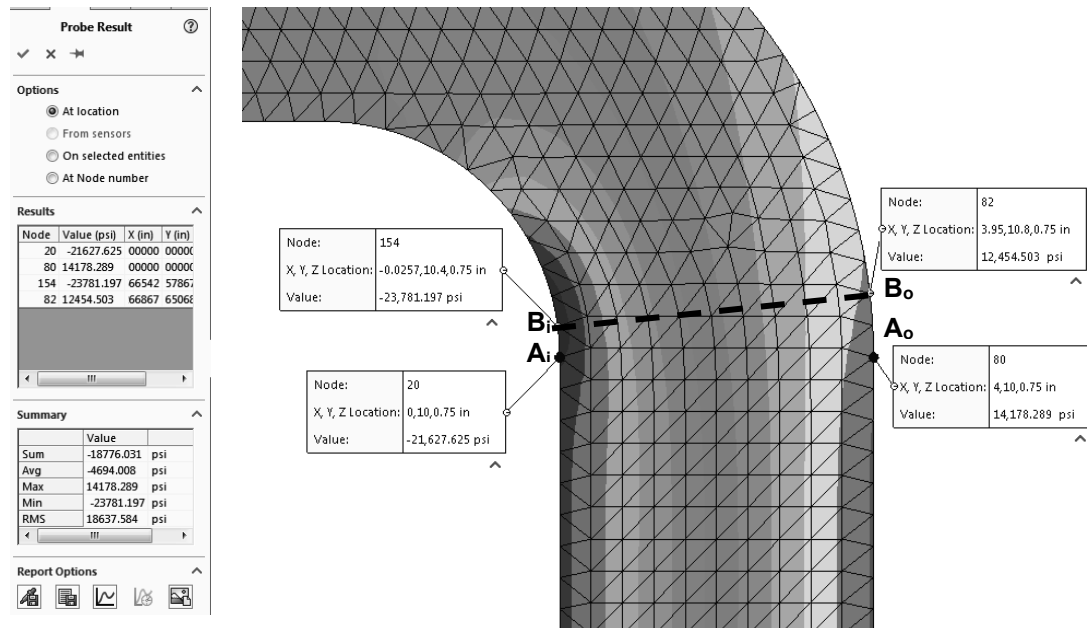



Figure 26 – Use the **Probe** tool to determine stress magnitudes at locations on the concave and convex sides of the curved beam model.

12. On the **Simulation** tab click the  **Plot Tools** icon and from the pull-down menu select the  **Probe** tool icon. The **Probe Result** property manager opens as shown on the left side of Fig. 26.
13. In the **Options** dialogue box, select **At location** (if not already selected).
14. Move the cursor over the straight vertical edges on the left and right sides of the model. Each edge is highlighted as the cursor passes over it. Click to select two nodes, indicated by a small circle, (one on the left and one on the right) located at the *top* end of each line. These nodes are located at the *intersection* between the straight vertical section and the beginning of the curved beam section. Selected nodes correspond to **A_i** and **A_o** in Fig. 26. If an incorrect node is selected, simply click **At location** in the **Options** dialogue box to clear the current selection and repeat the procedure. *Do not close the **Probe Result** property manager at this time.*

The above action records the following data in the **Results** dialogue box: **Node** number, **Value (psi)** of the plotted stress (σ_y), and the **X, Y, Z** coordinates of the selected nodes. Also, a small information “flag” appears adjacent to each node on the model and repeats

data listed in the **Results** table. *It may be necessary to click-and-drag column edges to view values in the **Results** table.*

Table I contains a comparison of results found by using classical curved beam equations and the finite element analysis results at locations **A_i** and **A_o**. Rounded values are used.

Table I – Comparison of stress (σ_y) from classical and finite element methods at Section A-A.

Location	Manual Calculation (psi)	Probe Tool Results (psi)	Percent Difference (%)
Point A_i	-24610	-21628	13.8%
Point A_o	11990	14178	15.4%

Examine all values and the **Percent Difference (%)** column. Although differences of this magnitude occasionally do occur, as an engineer you should be disappointed and, in fact, quite concerned at the significant difference between these results given the validity of the curved beam equations. However, when results differ by this magnitude it is always appropriate to *investigate further* to determine if there is a valid cause for the disparity and not simply “write off” the differences as due to the fact that two alternative approaches are used. Can you provide valid reason(s) *why* such large differences exist?

Further thought should reveal that St. Venant’s principle is once again affecting the results. In this instance, a traditional engineering approach would dictate using classical bending stress equations for a straight beam in the straight vertical segment of the model below Section **A-A**, in Fig. 1 (repeated at right), and curved beam equations in the portion of the model above Section **A-A**. Therefore, common sense suggests that there is a *transition region* between the straight and curved segments where neither set of classical equations is entirely adequate. In fact, due to the finite size of elements in this region, it is logical to presume that the finite element analysis provides a more accurate solution than do classical equations in this transition region.

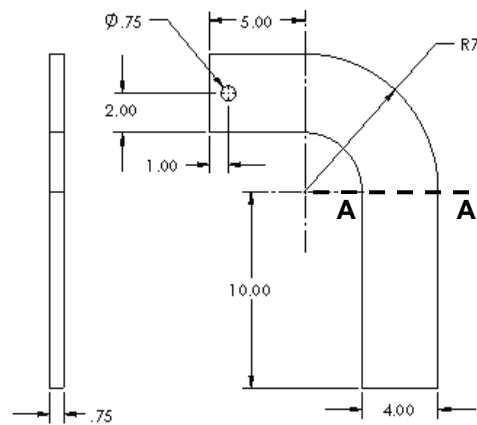

Figure 1 (Repeated) – Basic geometry of the curved beam model.

Given the above observations, we next proceed to sample stress magnitudes at Section **B_i-B_o** in Fig. 26. This new section is located slightly above the transition region. Proceed as follows.

15. Move the cursor over the curved edges of the model. Then, on the concave side click to select the *first* node *above* the previously selected node.

16. Next, on the convex side of the model, select the *second* node *above* the previously selected node. This procedure selects nodes **B_i** and **B_o** in Fig. 26.

Observe the two new stress magnitudes listed in the **Results** dialogue box and compare them to values listed in Table II. Nodes **B_i** and **B_o**, thus selected, lie on a radial line that forms an approximate angle of 7.5° above the horizontal. Stress values calculated using the classical equations are modified to account for a slight shift of the centroidal axis due to beam curvature and for the change in angle of the axial force. Using these values, a comparison of classical and FEA results in Table II reveals that values differ by at most 4.1%, which is a significant improvement over previous calculations.

Table II – Comparison of stress (σ_y) for classical and finite element methods at Section B_i-B_o. (Rounded values are used)

Location	Manual Calculation (psi)	Probe Tool Results (psi)	Percent Difference (%)
Point B_i	-24515	-23781	3.1%
Point B_o	11940	12454	4.1%

17. Click **[OK]** ✓ to close the **Probe Result** property manager.

This concludes the verification of Finite Element results, but note that even better results are expected at locations further from the transition region.

Assessing Safety Factor

SOLIDWORKS Simulation provides a convenient means to determine and view plots of Safety Factor distribution in the model. To use this capability, proceed as follows.

- In the **Simulation** tab, click ▼ on the **Results Advisor** icon and from the pull-down menu select **New Plot**. Then, from a second pull-down menu, select **Factor of Safety**. The **Factor of Safety** property manager opens as shown in Fig. 27 and displays the first step of a three step procedure.
- Read text in the yellow **Message** dialogue box *and* at bottom of the **Step 1 of 3** dialogue box. These messages indicate that Safety Factor is based on the failure criterion noted in the **Materials** window. That criterion was specified as **Max von Mises Stress**.
- In the upper pull-down menu of the **Step 1 of 3** dialogue box, choose either **All** or **Selected Bodies**. Because there is only one part to be analyzed, the result is the same in either case.
- Next, in the **Criterion** field, click ▼ the pull-down menu to reveal names of the four failure criteria available to determine the factor of safety.

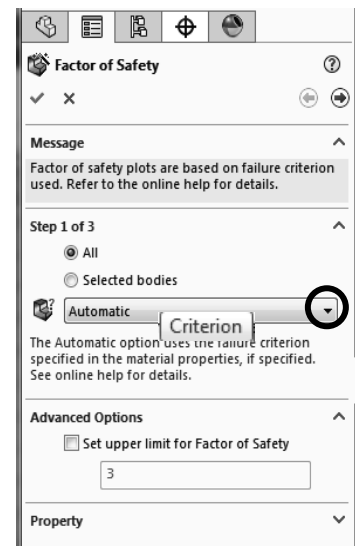

Figure 27- **Factor of Safety**, Step #1 of safety factor check

A brief overview of the four failure criteria is provided below.

- **Max von Mises Stress** – This failure criterion is used for ductile materials (aluminum, steel, brass, bronze, etc.). It is considered the best predictor of actual failure in ductile materials and, as such, provides a good indication of the true safety factor. This criterion is also referred to as the “Distortion Energy Theory.”
- **Max Shear Stress (Tresca)** – This criterion also applies to ductile materials. However, it is a more conservative theory thereby resulting in lower predicted safety factors. As a consequence of its conservative nature, parts designed using this criterion may be somewhat oversized.
- **Mohr-Coulomb Stress** – This failure criterion is applied to the design and analysis of parts made of brittle material (cast iron, etc.) where the ultimate compressive strength exceeds the ultimate tensile strength ($S_{uc} > S_{ut}$).
- **Max Normal Stress** – Also applicable for brittle materials, this failure criterion does not account for differences between tensile and compressive strengths. This theory is also regarded as the least accurate of the methods available.
- Other failure criteria apply for *shell* elements made of composite materials. These criteria are not described here.

5. Because the curved beam is made of ductile aluminum and because a good estimate of safety factor is desired, choose **Max von Mises Stress** from the pull-down menu.

Upon making the above selection, the **Factor of Safety** property manager changes to that illustrated in Fig. 28. Immediately below the **Criterion** field notice that the factor of safety check is currently defined as

$$\frac{\sigma_{vonMises}}{\sigma_{Limit}} < 1$$



Figure 28 – The failure criterion is selected in **Step 1 of 3** of the **Factor of Safety** dialogue box.

In other words, the above equation is currently set to identify locations in the model where the ratio of von Mises stress to the “limiting” value of stress (i.e., the Yield Strength) is < 1 .

Thus, the above criterion identifies locations where yielding of the model is *not* predicted because model Yield Strength, the denominator, is greater than the von Mises stress, the numerator. As initially defined, the above ratio is the *inverse* of the traditional safety factor definition, where:

$$\text{Safety Factor} = n = \text{strength}/\text{stress}$$

To plot only critical regions of the part, i.e., regions where the Yield Strength is exceeded and the safety factor is < 1 , proceed as follows –

6. Advance to the second step by clicking the right facing arrow button  at top of the **Factor of Safety** property manager. The **Step 2 of 3** dialogue box appears as shown in Fig. 29. It may be necessary to click and drag its bottom edge to expand the **Factor of Safety** dialogue box.
7. In the top pull-down menu, select **psi** as the set of **Units** to be used (if not already selected).
8. Under **Set stress limit to**, click to select **Yield strength** (if not already selected).
9. Do *not* change the **Multiplication factor**.

Notice that the material, **2014 Alloy** aluminum, and its Yield and Ultimate strengths appear at the bottom of this dialogue box.

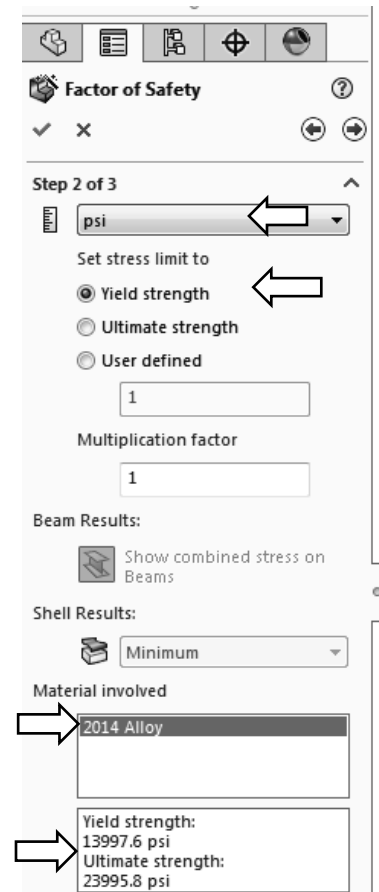



Figure 29 – **Step 2 of 3** in the **Factor of Safety** process.

Design Insight – Focus attention near the top of the **Step 2 of 3** dialogue box.

In the event that a *brittle* material is being analyzed using the Mohr-Coulomb or the Max Normal Stress failure criteria, it is appropriate to select the **Ultimate strength** as the failure criterion since brittle materials do not exhibit a yield point.

The **User defined** option is provided for cases where a user specified material is not found in the **Material Property** table.

10. Click the right facing arrow button  at top of this property manager to proceed to **Step 3 of 3** in the **Factor of Safety** property manager shown in Fig. 30.

Two options are available for displaying the factor of safety. Brief descriptions of each are provided on the next page.

- **Factor of safety distribution** – Produces a plot of safety factor variation throughout the entire part.
- **Areas below factor of safety** – A desired value for safety factor is entered in the field beneath this option. The resulting display shows all areas of the model below the specified safety factor in the color red and areas with a safety factor greater than the specified value in blue. This approach easily identifies areas that need to be improved during the design process.

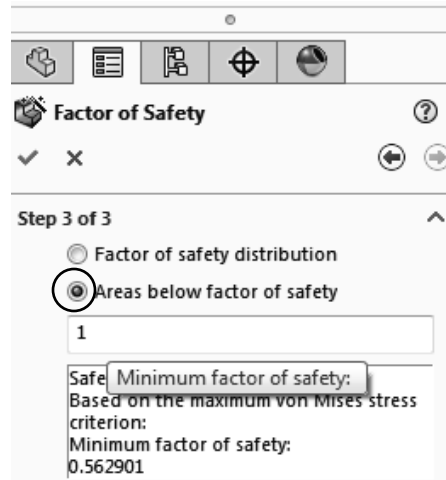

Figure 30 – Redefinition of **Factor of Safety** and values to be displayed on the new plot.

11. Beneath **Step 3 of 3**, select **Areas below factor of safety** and type “1” in the **Minimum factor of safety:** field (if not already “1”).

At the bottom of this dialog box the **Safety result** field informs the user that the *minimum* factor of safety is **0.562901** which indicates that the design is *not* safe in some regions of the model. Recall that this value is based on a comparison between Yield Strength and the maximum von Mises stress. (*Values may vary slightly from those shown.*)

Note that the above value of safety factor differs by only .016% from that computed using the reciprocal of the equation appearing in the first **Factor of Safety** window. That is:

$$\frac{\sigma_{Limit}}{\sigma_{vonMises}} = \frac{\text{Yield Strength}}{\text{Max. von Mises Stress}} = \frac{13997}{|-24870|} = 0.5628$$

12. Click **[OK]** ✓ to close the **Factor of Safety** property manager. A new plot folder, named **Factor of Safety1 (- Max von Mises Stress-)**, is listed beneath the **Results** folder. Also, a plot showing regions of the model where the Safety Factor < 1.0 (red) and where the Safety Factor > 1.0 (blue) is displayed.
13. Right-click **Factor of Safety1 (-Max von Mises Stress-)**, and from the pull-down menu select **Chart Options...** The **Minimum factor of safety** property manager opens.
14. In the **Display Options** dialogue box, check **Show min annotation** and click **[OK]** ✓ to close the **Minimum factor of safety** property manager.

The preceding step labels the location of minimum Safety Factor on the curved beam as shown in Fig. 31. As expected, this location corresponds to the location of maximum compressive stress previously illustrated in Figs. 20 and 25.

The figure now on your screen should correspond to Fig. 31. This figure shows regions where the factor of safety (FOS) is less than 1 (unsafe regions) in red. Regions with a factor of safety greater than 1 (safe regions) are shown in blue. Localized regions, along the right and left vertical edges and extending into the concave region, have a safety factor less than one.

The line of text, circled near the top-left in Fig. 31, provides a “key” to interpret safe and unsafe regions on the model.

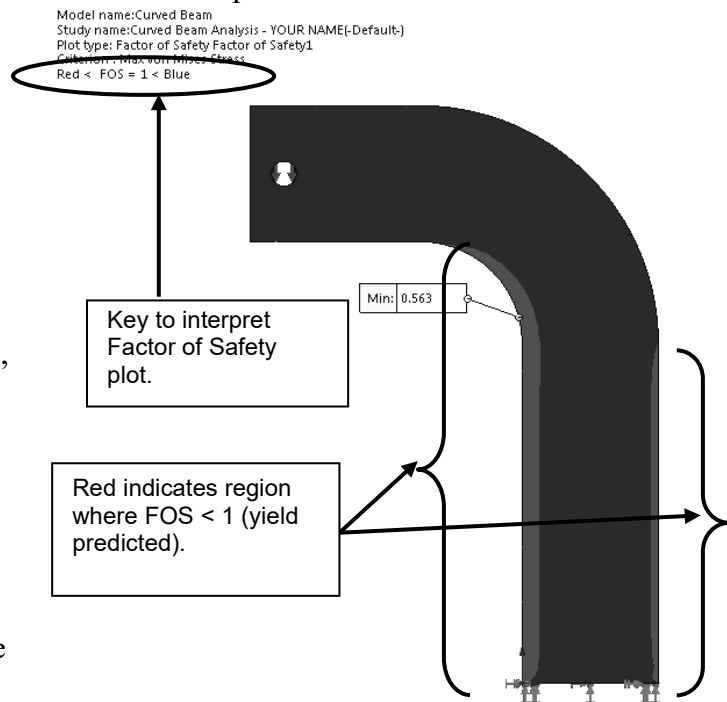

Figure 31 – Curved beam model showing areas where FOS > 1 (safety predicted) and where FOS < 1 (yield predicted).

15. Double-click **Factor of Safety (-Max von Mises Stress-)** and repeat steps 1 through 12 above, but this time set the **Areas below factor of safety** to **2** instead of **1**, in step 11. How does the plot change?

A designer can repeat the above procedure for any desired level of safety factor check.

In summary, an important aspect of the von Mises stress is that it can be used to predict whether or not a part might fail based on a comparison of its stress *magnitude* to the value of yield strength. This topic is aligned with the study of theories of failure found in most mechanics of materials and design of machine elements texts.

Analysis Insight #1:

Faced with the fact that the above part is predicted to fail by yielding, a designer would be challenged to redesign the part in any of several ways, depending upon design constraints. For example, it might be possible to change part dimensions to reduce stress magnitudes in the part. Alternatively, if part geometry cannot be changed due to size restrictions, a stronger material might be selected, or some combination of these or other possible remedies might be applied. Because part redesign might be considered an open-ended problem, it is not pursued here.

Analysis Insight #2:

Return briefly to the vonMises stress plot by double-clicking **Stress1 (-vonMises-)** located beneath the **Results** folder.

Refer to Fig. 32 or your screen and notice that the material yield strength (13997.6 psi) is displayed beneath the color coded stress scale. Also, an arrow appears adjacent to the stress scale at a magnitude corresponding to this yield strength. Thus, all stresses above the arrow *exceed* the material yield strength. Given this observation it is logical to ask, “What is the meaning of stress values above the material yield strength?”

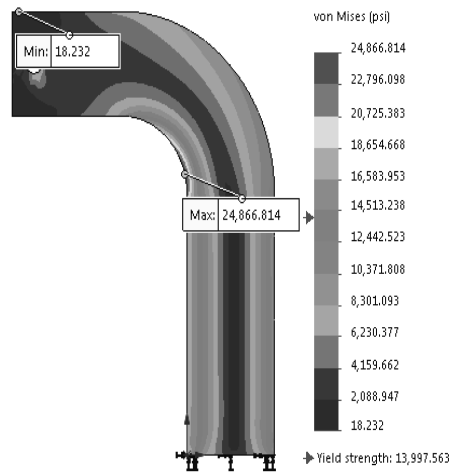

Figure 32 – von Mises stress plot for the curved beam model.

The answer to this question is quite straightforward. Stress values greater than the yield strength are *meaningless!* Why is this true?

Recall that the stiffness approach, described in the Introduction, indicated a finite element solution starts by determining deflection ΔL of a part subject to applied loads. Then, based on deflection, strain is calculated as $\epsilon = \Delta L/L$. And finally, from strain, stress is calculated from the relation $\sigma = E \cdot \epsilon$. In words, the last equation states that “stress is proportional to strain,” where the constant of proportionality **E** (i.e., the modulus of elasticity) is determined from the slope of the *linear* portion of the stress strain curve illustrated in Fig. 33.

Because the FEA solution is based on a *linear analysis*, stress values *above* the yield strength in Fig. 32 are *assumed* to lie along a *linear* extension of the stress-strain curve shown dashed in Fig. 33. However, above the yield strength, the actual stress-strain curve follows the *solid* curved line where stress is no longer proportional to strain. Thus, stress values reported above the yield strength are meaningless.

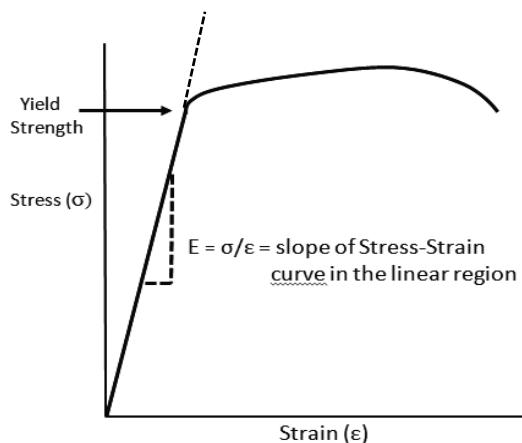



Figure 33 – Stress vs strain curve for a typical elastic material shown by the solid curve.

Problems where stress exceeds the yield strength can be solved in the Professional version of SOLIDWORKS Simulation where *non-linear* analysis capabilities are available to conduct post-yield analysis.

Alternate Stress Display Option

Because some users might prefer more immediate feedback to identify areas where material yield strength is exceeded, this section outlines steps to quickly identify those regions in a part. This option is only valid for von Mises stress plots. Another restriction is that this display option only applies to individual parts. It does not apply to assemblies because individual parts within an assembly might be made of different materials each with their own yield strength. Change the display as follows.

1. Beneath the **Results** folder, right-click **Stress1 (-vonMises-)** and from the pull-down menu select **Chart Options...** The **Stress plot** property manager opens. The bottom *portion* of this property manager is shown in Fig. 34.
2. At the bottom of this property manager, click  to open the **Color Options** dialog box.
3. Place a mark to select **Specify color for values above yield limit** and accept the default gray color specified.

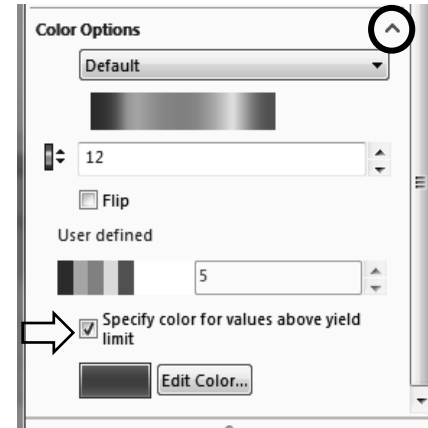

Figure 34 – Customizing displays where stress exceeds yield strength on von Mises plots.

4. Immediately shades of gray are displayed on regions of the model and in the color coded stress chart where von Mises stress exceeds the material yield strength.

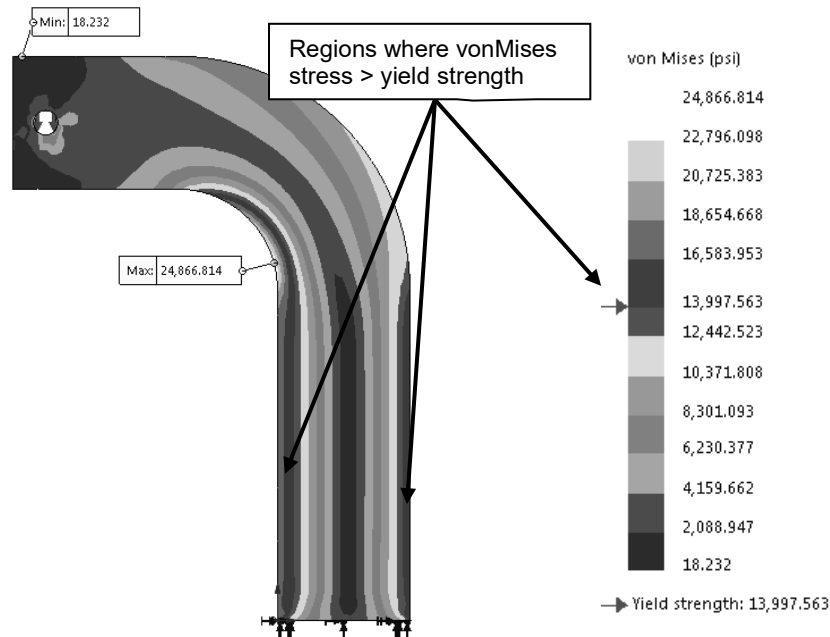

Figure 35 – Altered plot displays stresses greater than the yield strength in shades of grey.

5. Because it is not desired to keep this display, click **✕** to close the **Stress Plot** property manager.

The plot produced using this technique appears in Fig. 35 where all stress magnitudes greater than the material yield strength are displayed in gray tones. Although this plot does not provide insight into magnitude of the Safety Factor, or lack thereof, it does reinforce the concept that stress magnitudes above the yield strength are meaningless. The shades of gray are unimportant.

Determining Reaction Forces

It is always good engineering practice to verify that results obtained correlate well with the given information. One simple way to confirm that results correlate with given information is to check whether or not reaction forces are consistent with external loads applied to the model. This section examines how to determine reaction forces at the base of the curved beam model. To accomplish this, proceed as follows.

1. On the **Simulation** tab, click **▼** on the **Results Advisor** icon and from the pull-down menu, select **List Result Force**. The **Result Force** property manager opens as shown in Fig. 36.
2. In the **Options** dialogue box, verify that **Reaction Force** is selected.
3. In the **Selection** dialogue box, set **Units** to **English (IPS)** (if not already selected).
4. The **Faces, Edges, or Vertices** field is active (highlighted light blue) and awaiting selection of the entity on which the reaction force is to be determined. Rotate the model so that its bottom (restrained) *surface* is visible and click to select it. **Face<1>** appears in the active field. This is the only face where reactions occur.
5. Click the **[Update]** button and the **Reaction force (lbf)** table at the bottom of the property manager is populated with data. Also, X, Y, and Z reaction force components appear at the base of the model and force magnitudes are contained within an information “flag” on the model.

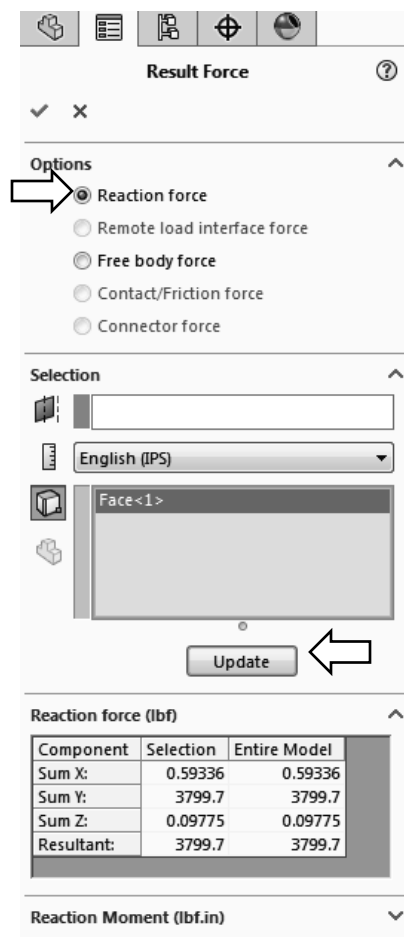

Figure 36 – Data appearing in the **Result Force** property manager.

The **Component** column in this table lists names for the summation of reaction forces in the X, Y, and Z directions and the **Resultant** reaction. Reaction force magnitudes listed in the **Selection** column are identical to those in the **Entire Model** column. This result is expected because the entire model is restrained at only this one location.

Results interpretation is as follows: (due to mathematical round-off values may vary)

SumX: 0.5934 (close to zero) no force is applied to model in the X-direction

SumY: 3799.7 (essentially 3800 lb) equal and opposite to the applied force

SumZ: 0.0977 (close to zero) no force is applied to model in the Z-direction

Resultant: 3799.7 (essentially 3800 lb = the applied force)

It should be noted that a *moment* reaction at the base of the curved beam is missing from the **Reaction force** table. Also open  the **Reaction Moment (lbf.in)** dialogue box, located below the **Reaction force** dialogue box, and observe it contains no data entries (i.e., no moment reactions). This outcome does not agree with the usual conventions for reactions applied to a free-body diagram used in a traditional engineering statics course and shown in Fig. 2 (repeated at right). However, lack of a moment is consistent with our understanding of **Immovable** restraints applied to three-dimensional tetrahedral elements. Recall, **Immovable** restraints only restrict translations in the X, Y, and Z directions at each restrained node on these elements. This observation accounts for the fact that there are only three force reactions and no moments in the **Reaction force** and **Reaction Moment** tables of Fig. 36.

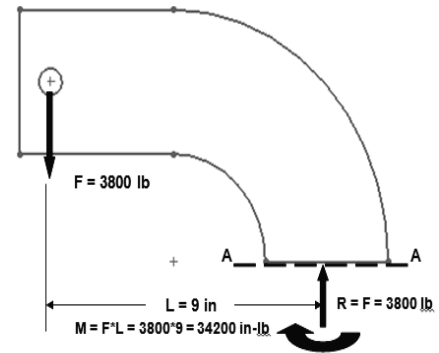

Figure 2 – (Repeated)

The reaction force results above are valid for the *entire model*. However, in many instances a model is supported (i.e., restrained) at more than one location. In those instances it is necessary to determine reaction forces at other locations on a model. Performing a reaction check is quite simple and can be viewed as an additional means to verify the validity of boundary conditions applied to a model.

Although a surface was selected to examine reaction forces in the above example, it should be evident that other geometric features, such as edges or vertices, can also be selected at other restrained locations on a model.

6. Click **[OK]** ✓ to close the **Result Force** property manager.

Is it Significant That the Model is NOT in Equilibrium?

To answer the above question some additional insight is necessary. Begin by recalling Newton's second law of motion, which states any unbalanced force acting on a body results in an acceleration of that body in the direction of the unbalanced force. This

motion is referred to as “rigid body motion” and it follows that such motion is not tolerated in a *static* finite element analysis. Simply stated, rigid body motion refers to motion (displacement) of an entire model irrespective of whether or not the body deforms due to applied loads.

For example, in the case of the curved beam model it is *not critical* that reaction forces *are not equal to zero* in all directions. Although these results indicate that true equilibrium is *not* attained, because $\sum \mathbf{F}_x \neq 0$, $\sum \mathbf{F}_y \neq 0$, and $\sum \mathbf{F}_z \neq 0$, the model cannot move because its base is **Fixed** by **immovable** restraints applied in the X, Y, and Z directions. In summary, if a model is supported by **Fixed** restraints in all possible directions, then the fact that mathematical round-off occurs is of no consequence to equilibrium.

Soft Springs Can Be Applied Where Other Restraints are not Appropriate

Occasionally cases occur where model integrity is compromised by adding extra restraints. Consider for example the model shown in Fig. 37 at right, where the model is subject to “equal and opposite” forces applied to its top and bottom holes. In this case it is assumed that the model *cannot be supported by additional Fixed restraints* without interfering with accurate modeling of actual forces acting on the model. However, as we saw above, **Reaction Forces** resulting from a finite element analysis typically do not equal zero in the X, Y, and Z directions due to mathematical round-off. The resulting *unbalanced* force(s), no matter how small, would cause the model to move with rigid body motion.

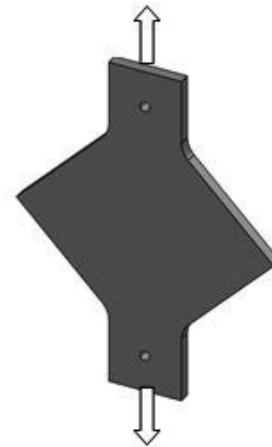

Figure 37 - Model subject to “equal” but opposite forces.

Because model movement with rigid body motion is prohibited within the software, what actually happens is that the Solution *fails to execute* and a message warning that . . . a “singular stiffness matrix” has occurred . . . is displayed. Although this message is fairly obtuse, it simply indicates that the model is insufficiently restrained and, therefore, the resulting equations cannot be solved as presently formulated.

One way to deal with unbalanced forces is to apply *Soft Springs* to support the model. These “springs” serve to stabilize a model against any unbalanced forces; therefore, the analysis can proceed. Look for end-of-chapter problems where a model must be supported by *Soft Springs* to overcome *unbalanced* reaction forces that otherwise would result in rigid body motion. Exercises 3-3 and 5-4 offer guidance regarding how to apply *Soft Springs* in the event they are needed.

Important Caution Regarding Strength and Safety Factor

Earlier discussion in this chapter noted that von Mises stress magnitude is a valid way to represent a complex state of stress within a body by a *single* value. Likewise, material properties such as Yield Strength, Ultimate Strength, etc. are provided as *single* values in the material properties table. As a user of this software, and for manual calculations too, designers must be aware and account for the fact that *statistical variation applies to all values* used. The preceding statement about statistical variation of values applies to, but is not limited to, quantities such as part dimensions, applied loads, load geometry, and material properties. Accounting for statistical variation is an important design/analysis consideration.

Logging Out of the Current Analysis

This concludes an introduction to analysis of the curved beam model. It is suggested that this file *not* be saved. Proceed as follows.

1. On the **Main Menu**, click **File** followed by choosing **Close**.
2. The **SOLIDWORKS** window opens in Fig. 38 and provides the options of either saving the current document or not. Select **[Don't Save]**.

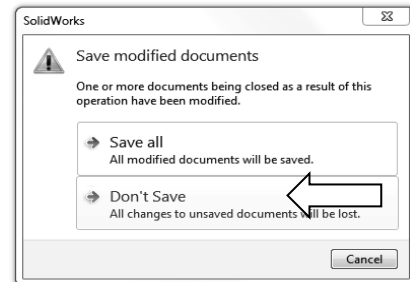

Figure 38 – **SOLIDWORKS** window prompts users to either save changes or not.

EXERCISES

End of chapter exercises are intended to provide additional practice using principles introduced in the current chapter plus capabilities mastered in preceding chapters. Most exercises include multiple parts. In an academic setting, it is likely that parts of problems may be assigned or modified to suit specific course goals.

⚡ Designates problems that introduce new concepts. Solution guidance is provided for these problems.

EXERCISE 1 – Curved Beam Stresses in a “C”- Clamp

C-clamps, like that illustrated below, must pass minimum strength requirements before they can be qualified for general purpose use. Clamps are tested by applying equal and opposite loads acting on the two gripping faces. Federal test criteria also requires that the movable (lower) jaw be extended a fixed percentage of the distance of the fully-open state to ensure that column failure of the screw is an integral part of the test. Assume that the movable jaw of the clamp in Fig. E2-1 satisfies the prescribed test criterion, then perform a finite element analysis of the C-clamp subject to the following guidelines.

Open file: **C-Clamp 2-1**

- Material: **Cast Carbon Steel** (use S.I. units)
- Mesh: In the **Mesh** property manager, select **Standard mesh**.
- Fixture: **Fixed** applied to the upper gripping surface of the C-clamp.
- External Load: **950 N** applied downward normal to the lower gripping surface.

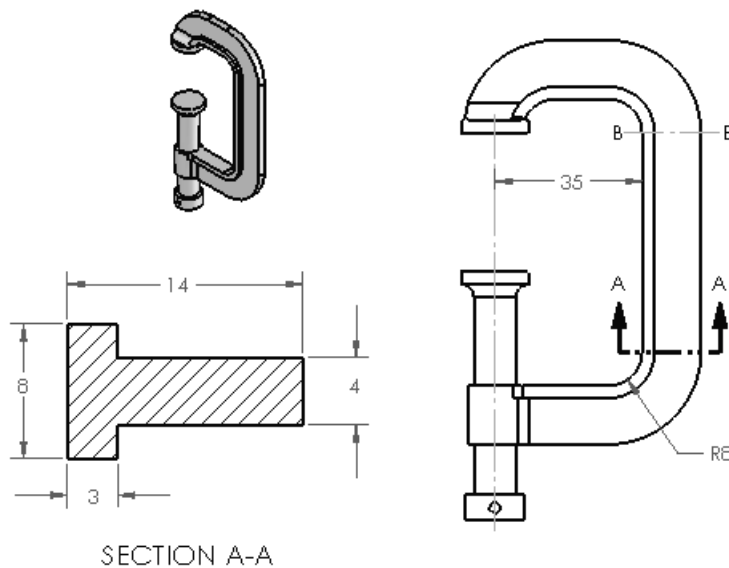

Figure E2-1 (a) – “C”-clamp frame and cross-section dimensions. Stress to be determined at Section A-A. (All dimensions in mm.)

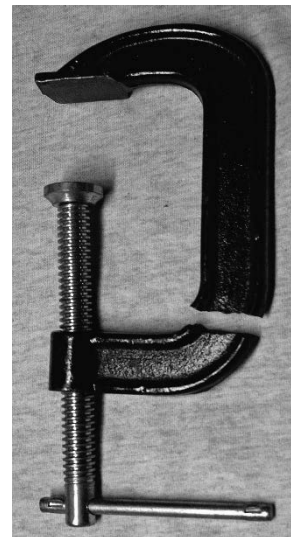

Figure E2-1(b) – Typical failure.

Determine the following:

- Use classical equations to compute stress at the inside and outside surfaces of the C-clamp frame at section A-A. Section A-A is located where the straight and curved sections are tangent. Include a free body diagram of the lower portion of the clamp and use curved beam equations.
- Create a stress contour plot of von Mises stress in the frame of the C-Clamp. The plot is to include discrete fringes and show the mesh on the model. Also include automatic labeling of maximum and minimum von Mises stress on this plot.
- Like part (b), except produce a plot of the *most appropriate stress* in the C-Clamp frame. In other words, because values from this plot are to be compared with manual calculations of part (a), it is necessary to choose the corresponding stress from those available within the **Stress Plot** property manager. Include automatic labeling of maximum and minimum stress on this plot.
- Use the **Probe** feature to produce a graph of the *most appropriate stress* acting across section A-A. When using the **Probe** feature, begin on the concave (inside) surface at the middle node shown in Fig. E2-2. This location corresponds to the tangent line between the curved and straight segments of the clamp. Then proceed around $\frac{1}{2}$ of the model selecting both corner and mid-side nodes. Continue to the outside of the “T” cross-section. Include a descriptive title, axis labels, and your name on this graph. Beneath the graph, use equation [1] to compare percent differences between classical and FEA determination of stresses at the inside and outside surfaces.

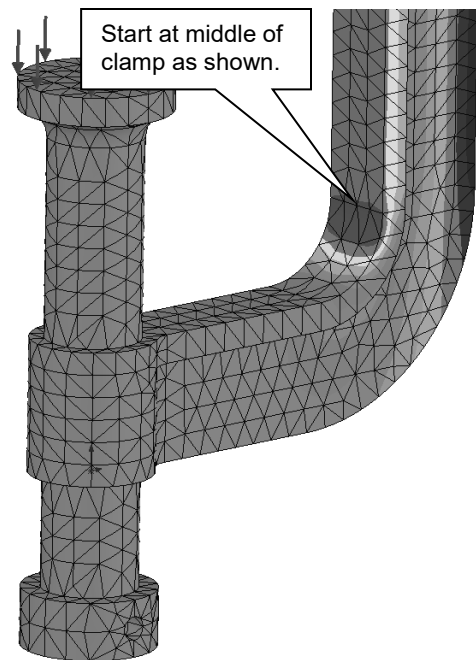

Figure E2-2 – Image shows starting point for use of the **Probe** tool.

$$\% \text{ difference} = \frac{(\text{FEA result} - \text{classical result})}{\text{FEA result}} * 100 = \quad [1]$$

Because there may be several nodes on the inside and outside surfaces of the C-clamp, tell which node or nodes you selected to compare stress values with those computed manually. Also, tell why a particular node(s) was/were selected.

- e. Assuming the C-clamp is made of a ductile material, produce a plot showing regions where the safety factor < 1.5 . Also, if the safety factor is < 1.0 at any location within the C-clamp, produce a second plot to highlight any un-safe region(s). Manually label region(s), if any, where safety factor < 1.0 .

EXERCISE 2 – Curved Beam Stresses in Hacksaw Frame

A common, metal-cutting “hacksaw” is shown in Fig. E2-3. A solid model of the hacksaw is available as file **Hacksaw 2-2**. The model is simplified to include two 0.125 inch diameter holes that pass through the lower left and lower right ends of the hacksaw “backbone” labeled in Fig. E2-3. For analysis purposes, the inside surface of the left-hand hole is to be considered **Fixed** (i.e., immovable). Use split lines to create a small “patch” of area on the inside surface of the hole located at the right end of the backbone. On this surface apply a 50 lb force induced by a tensile load in the saw blade, which is ordinarily held in place between these two holes. Assume the following.

- Material: **AISI 1020 Steel, Cold Rolled** (use English units)
- Mesh: In the **Mesh** property manager, select **Standard mesh**; use the default mesh size.
- Units: **English (IPS)**
- Fixture: **Fixed** applied to inside of left hole.
- External Load: **50 lb** applied parallel to the X-direction on the inner surface of the right-hand hole (split lines needed; placement of split lines is user defined).

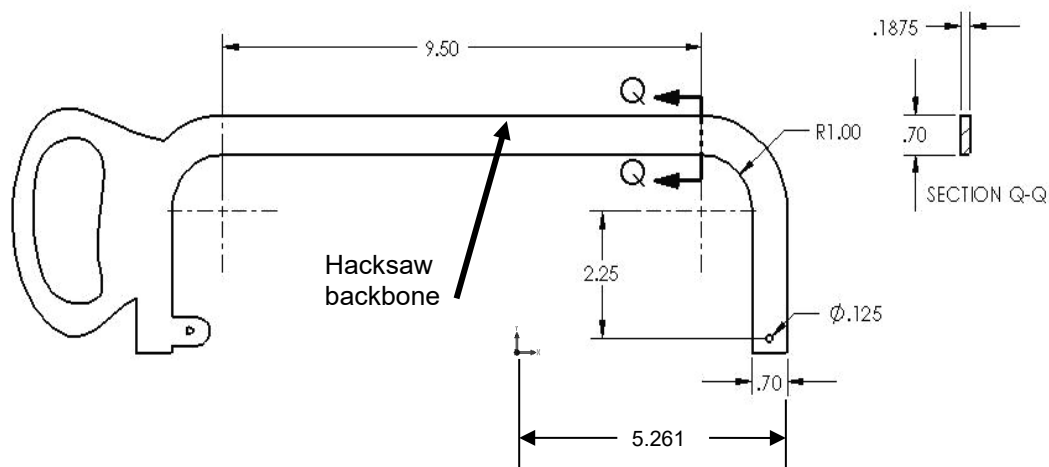

Figure E2-3 – Basic geometry of a hacksaw frame. Stress is to be determined at Section Q-Q.

Determine the following:

- Use classical curved beam equations to compute stress at the inside (concave) and outside (convex) surfaces of the hacksaw frame at section Q-Q. Section Q-Q is located where the straight and curved sections are tangent. Include a labeled free body diagram of the right-portion of the model.
- Include a zoomed-in image of the right-hand hole so that the 50 lb applied load can clearly be seen to act between user specified *Split Lines* within the hole.
- Create a stress contour plot of von Mises stress in the saw backbone. Include automatic labeling of maximum and minimum von Mises stress on this plot.
- Use the **Probe** feature to produce a graph of the *most appropriate stress* across section Q-Q, beginning at the inside (concave) surface and continuing to the outside (convex) surface of the backbone cross-section. Use the **Stress Plot** property manager to select the *appropriate stress* for this plot to enable comparison with manual calculations of part (a). Include a descriptive title, axis labels, and your name on this graph. Also, below the graph, cut-and-paste a copy of the **Probe Results** table showing values used in this comparison [see Appendix A for procedures to copy SOLIDWORKS images into a Word® document]. Then use equation [1], repeated below, to compute the percent difference between classical and finite element solutions at the inside and outside surfaces of the saw backbone at section Q-Q.

$$\% \text{ difference} = \frac{(\text{FEA result} - \text{classical result})}{\text{FEA result}} * 100 = \quad [1]$$

- Based on von Mises stress, create a plot showing all regions of the model where Safety Factor < 4.0 and circle these regions on the plot. Include a software applied label indicating the maximum and minimum values for Factor of Safety.
- Question: If stresses at section Q-Q, calculated using both classical equations and the finite element solution, differ by more than 4%, state the reason for this difference and describe at least one method to reduce the percent difference calculation at this location.

EXERCISE 3 – Stresses in a Curved Anchor Bracket

The curved beam shown in Fig. E2-4 is subject to a horizontal load applied by means of a pin (not shown) that passes through a hole in its upper end. A solid model of this part is available as file **Anchor Bracket 2-3**. The lower-left end of the part is attached to a rigid frame (also not shown). Because three-dimensional tetrahedral elements are to be used to model this part, the restraint at this location should be considered **Immovable**. Use split lines to create a small “patch” of area on the inside surface of the 16 mm diameter hole. Locate these split lines 24 mm from the right edge of the model. On this inner surface of

Analysis of Machine Elements Using SOLIDWORKS Simulation

the hole apply a horizontal force of 8600 N acting in the positive X-direction (to the right). Assume the following.

- Material: **AISI 1010 Steel, hot rolled bar** (use SI units)
- Mesh: In the **Mesh** property manager, select **Standard mesh**; use the default mesh size.
- Fixture: Apply a **Fixed** (immovable) restraint on the inclined surface.
- External Load: **8600 N** in the X-direction applied on the right, inside surface of the 16 mm diameter hole between user defined *Split Lines*.

Determine the following:

- Use classical equations to compute stress at the inside (concave) surface and the outside (convex) surface of the anchor bracket at section B-B. Section B-B passes through the center of curvature of the curved beam and is considered to be a vertical line. Include a labeled free body diagram of the portion of the anchor bracket to the right of section B-B (show magnitude and direction of all reactions).
- Include a zoomed-in image of the hole so that the force $F_x = 8600$ N can clearly be seen to act between user specified *Split Lines*.
- Create a stress contour plot of von Mises stress in the anchor bracket. Include automatic labeling of maximum and minimum stress on this plot.

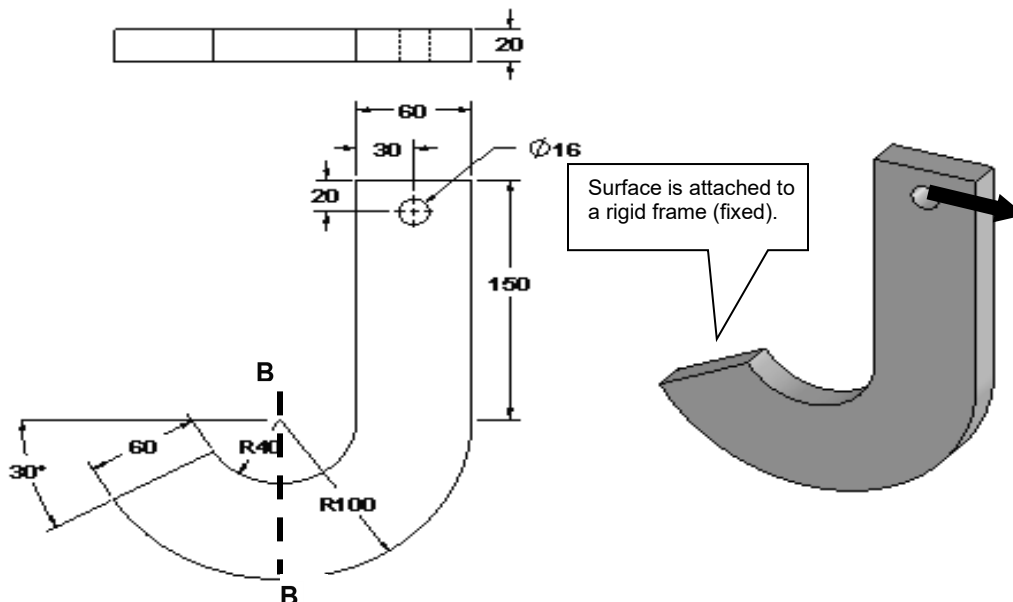



Figure E2-4 - Dimensioned view of the Anchor Bracket. Stress is to be determined at Section B-B.

- Using von Mises stress, create a plot showing all regions of the model where Safety Factor < 1.5 (if any). Indicate this region(s), if any, by circling its

location(s) on the figure and labeling them as “FOS < 1.5.” Include a software applied label indicating locations of maximum and minimum values of Safety Factor. Even if region(s) where Safety Factor < 1.5 are found, tell whether or not the entire model can be classified as having no region(s) where safety factor < 1.0.

- e. Use the **Probe** feature to produce a graph of the *most appropriate stress* across the bracket at section B-B. Begin at the inside (concave) surface and continue to the outside (convex) surface. (See the “*HINT*” below for guidance when making this graph.) Use the **Stress Plot** property manager to select the *appropriate stress* for this graph to enable comparison with manual calculations of part (a) above. Add a descriptive title, axis labels, and your name to this graph.

Below the graph or on a separate page either: (a) cut-and-paste a copy of the **Probe Results** table that includes values used for this comparison [See Appendix A for procedures to copy images from SOLIDWORKS Simulation into a Word® document], or (b) click the **Save** icon  located in the **Report Options** dialogue box, to create an Excel spreadsheet containing all values in the **Probe Results** table. [See Appendix A, page A-12.]

After determining both classical and FEA results at section B-B, use equation [1] to compute the percent difference between classical and finite element solutions at the inside and outside surfaces of the bracket.

$$\% \text{ difference} = \frac{(\text{FEA result} - \text{classical result})}{\text{FEA result}} * 100 = \quad [1]$$

- f. If results of part (e) differ by 4% or more, determine the source of error in either the classical solution or finite element solution and correct it. If no error is found, state why results differ by this significant percent difference.

HINT: Because the **Standard mesh** generation scheme within SOLIDWORKS Simulation creates an optimized mesh, it is probable that (a) a straight line of nodes will *not* exist across the model at section B-B (thus, choose the best straight line available), and (b) it is also *unlikely* that node points *occur exactly on a vertical line through the center of curvature*. For these reasons, and to obtain the best estimate of stress on a vertical line through section B-B, proceed as follows.

- Zoom in on a *front* view of the model with a mesh displayed at section B-B.
- On the **Simulation** tab, select the **Plot Tools** icon and from the pull-down menu click the **Probe** tool  icon. This action opens the **Probe Results** property manager.
- In the SOLIDWORKS Feature manager, move the cursor over the **Right Plane** label. This action highlights an edge view of the **Right Plane** at the desired location. This edge view (a line) will assist in locating nodes closest to a vertical line at Section B-B. Unfortunately the line disappears when the cursor is moved, but it can be re-displayed multiple times by again moving the cursor over the **Right Plane** label. Complete the graph using the **Probe** tool.

EXERCISE 4 – Stresses in a Curved Photoelastic Model
 (Special Topics Include: Custom material definition, and using a “Hinge” joint for Fixture)

A curved beam model, made from a photoelastic material and subject to axial load **F**, is shown in Fig. E2-5. Beams such as this might be used in an experimental stress analysis laboratory where photoelastic techniques are studied. Photoelastic material has a unique optical property known as birefringence. Thus, when a photoelastic model is subject to applied loads in a field of polarized light, the light passing through the model undergoes changes of wavelength that produce visible “fringes” within the model as shown.

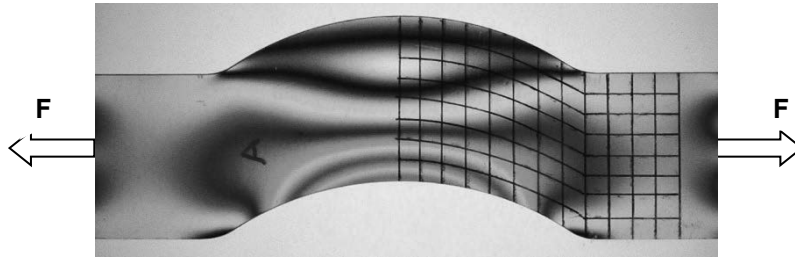

Figure E2-5 – “Fringes” appearing in a photoelastic model subject to a tensile load applied through pin joints (not shown). A grid is superimposed on the model to facilitate locating specific stress magnitudes and directions in the lab.

These “fringes” are analogous to, but not equal to, stress contour plots produced upon completion of a finite element analysis. In this exercise, stresses produced within the curved beam model are examined using finite element methods. Dimensioned views of a typical photoelastic beam are shown in Fig. E2-6.

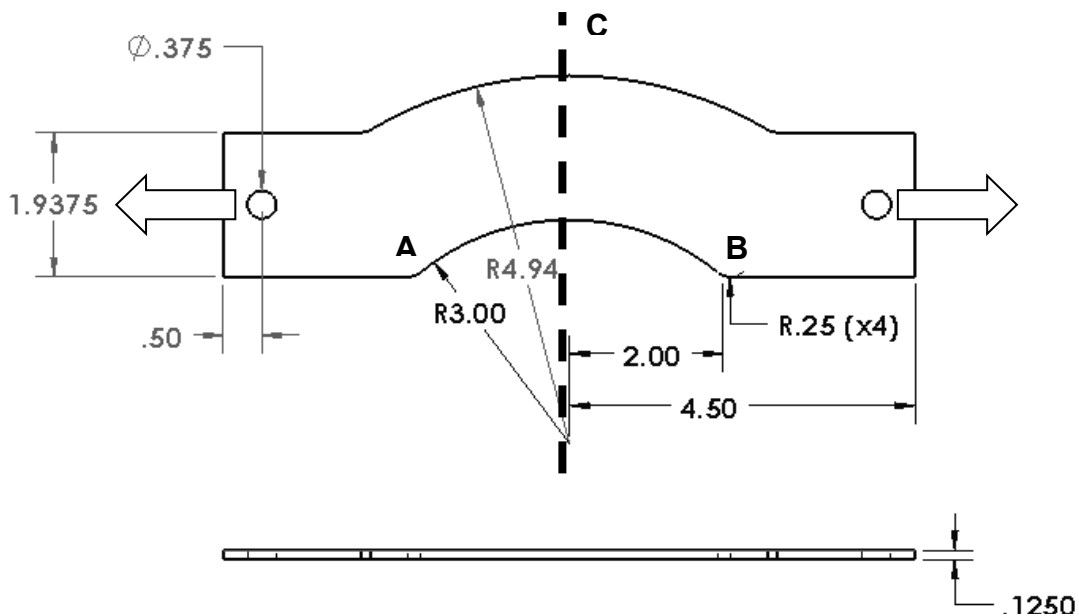

Figure E2-6 – Top view (above) and front (edge) view of a curved beam model. (Dimensions: inches)

Create a finite element model of this part that includes custom material specification, fixtures, external loads, mesh, solution, and results analysis.

Open the file **Curved Bracket 2-4**

- **Material:** Material properties are not found in the SOLIDWORKS material Library (use custom properties below)
 $E = 360e3$ psi Modulus of Elasticity (use English units)
 $\nu = 0.38$ Poisson's ratio
 $S_y = 2200$ psi Yield Strength
- **Mesh:** In the **Mesh** property manager, select a **Standard mesh**; use the default mesh size. (Although this model is very thin, use a solid mesh.)
- **Fixture:** **Hinge Joint** applied at hole on left end of the model.
- **External Load:** **72 lb** in the X-direction applied between user defined split lines on the inner surface of the hole located at the right end of the model.

Two aspects of this exercise are unique. First, properties of the photoelastic material are not available in the SOLIDWORKS material library. And second, the fixture at the left hole of the curved bracket is considered to be a **Fixed Hinge** joint. Guidance in the application of these two items is provided below.

Solution Guidance

It is assumed that the user has opened the model file and started a Study in SOLIDWORKS Simulation. The following instructions are to serve as a “guide”; they are less detailed than the step-by-step procedure found in example problems.

Custom Material Specification

The recommended way to create a custom material definition is to begin with a *similar* existing material and then edit material properties as outlined below.

- Open the **Material** window by right-clicking the **Curved Bracket 2-4** folder and selecting **Apply/Edit Material...**
- Close all open pull-down menu(s) beneath **SOLIDWORKS Materials**.
- Because photoelastic material is a special, clear “plastic like” material, open the **Custom Materials** folder at the bottom of the **SOLIDWORKS Materials** list.
- Next click “▶” to open the **Plastic** folder and beneath it select **Custom Plastic**. The right side of the window is populated with property values for an unspecified plastic material.
- On the **Properties** tab, select **Units:** as **English (IPS)**.

- Adjacent to the **Name:** field, change the name “Custom Plastic” to “**Photoelastic Material.**” The **Description:** and **Source:** fields can be left blank.
- Within the **Property** column of the lower table notice that red, blue, and black colors are used to indicate different **Property** names. Red lettering indicates information *required* for a stress solution. Blue lettering indicates *desirable, but not necessary* information. And property names appearing in black are used for thermal and vibration studies and are *not required* for the current Study. For each red item, enter the values listed beneath “Material” in the problem statement, but do not change the existing value in the **Mass density** field. Do not alter other values listed in the table.
- Click [**Apply**] followed by [**Close**] to exit the **Material** window. A check “✓” appears on the **Curved Bracket 2-4** part folder and the **Name:** assigned above appears on the part folder. You have successfully defined a custom material.

Fixed Hinge Specification A **Fixed Hinge** joint acts like a door hinge. This joint type allows rotation about a fixed axis on the model, but prevents translation along that axis. A **Fixed Hinge** is used at the left end of **Curved Bracket 2-4** to prevent translations in the X, Y, Z directions, but allows the model to rotate thereby maintaining alignment with the external load *as the part deforms*. Proceed as follows.

- Right-click the **Fixtures** folder and from the pull-down menu select **Fixed Hinge...** The **Fixture** property manager opens as shown in Fig. E2-7.
- In the **Standard (Fixed Hinge)** dialogue box, the **Cylindrical Faces for Fixture** field is highlighted (light blue).
- Zoom in on the left hole of the model and select its *inner surface*. **Face<1>** appears in the highlighted field, shown in Fig. E2-7. This cylindrical surface has an axis perpendicular to the model face.

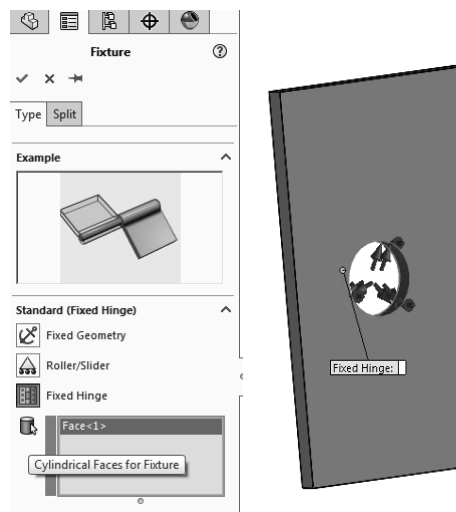

Figure E2-7 – Specifying a **Fixed Hinge** restraint.

- Click [**OK**] ✓ to close the **Fixture** property manager.

Solution Guidance (continued)

A **Fixed Hinge** restraint allows the model to undergo rotations about the selected hole, but no translations perpendicular to the hole. The remainder of this solution uses previously mastered procedures.

Special Solution Note:

Due to specification of a **Fixed Hinge** on this model, it is likely that the following warning message will appear during the **Solution** portion of this analysis.

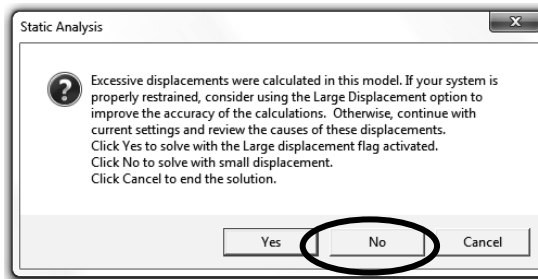

If the above **Static Analysis** window appears, click the [**No**] button, and continue with the “small displacement” Solution.

Determine the following:

- Use classical equations to compute stress at the inside (concave) surface and the outside (convex) surface of the curved bracket model at section C-C. Section C-C passes through the center of curvature and is considered to be an edge view of the **Right Plane** in the top view of Fig. E2-6. Include a free body diagram of the portion of the model to the right of section C-C; label all magnitudes and directions.
- Turn *off* the deformed image. Then, include a zoomed-in image of the right hole so that the external load, $F_x = 72$ lb, can clearly be seen to act between user specified *Split Lines* on the inner surface of the hole.
- Create a stress contour plot showing the *most appropriate stress* that should be analyzed acting across section C-C. The *most appropriate stress* should correspond to the stress calculated in part (a). Do stress fringes on the FEA model loosely approximate those shown in the photograph in Fig. E2-5?
- Use the **Probe** feature to produce a graph of the *most appropriate stress* across section C-C, begin at the inside (concave) surface and continue to the outside (convex) surface of the model. (See the “*HINT*” near the end of this problem for guidance when making this graph.) Use the **Stress Plot** property manager to select the *appropriate stress* for this plot to enable comparison with manual

calculations of part (a) above. Include a descriptive title, axis labels, and your name on this graph.

Below the graph, or on a separate page, either (a) cut-and-paste a copy of the **Probe Results** table that includes values used for this comparison (see Appendix A for procedures to copy SOLIDWORKS Simulation images into a Word® document), or (b) click the **Save**  icon, located in the **Report Options** dialogue box, to create an Excel spreadsheet containing all values in the **Probe Results** table. (See Appendix A, page A-12.) This spreadsheet can be inserted onto the page beneath the current graph. In either table, circle and label magnitudes of stress on the concave and convex surfaces at section C-C.

After determining both classical and FEA results at section C-C, use equation [1] (repeated below) to compute the percent difference between these results at the concave and convex surfaces of the model.

$$\% \text{ difference} = \frac{(\text{FEA result} - \text{classical result})}{\text{FEA result}} * 100 = \quad [1]$$

- e. On the **Probe** graph created in part (d), label the distance of the neutral axis (neutral plane) from the concave edge of the model at section C-C. Write a brief statement indicating how this value was determined. Compare this value with the location of the neutral axis determined using classical equations.
- f. Return to the plot produced in part (c). This time use the **Probe** tool to sample stress magnitudes along the concave edge of the model beginning at point **A** and proceeding from node-to-node until reaching point **B** (see Fig. E2-6). Include a graph of these results with your analysis. Add a descriptive title, axis labels, and your name to this graph.
- g. **QUESTIONS:** Answer the following questions on a separate page.
 - Is the variation of stress through the middle of the model shown in the graph of part (d) expected? Why?
 - Is the variation of stress shown on the graph of part (f) expected? Why?
 - Is the location of the neutral axis determined in part (e) located where it is expected to occur on the curved bracket model? Does the neutral axis of a curved member subject to axial load *always* occur at a location *like* that shown in the plot of part (e)? Explain why or why not.
- h. Using von Mises stress, create a plot showing all regions of the model where Safety Factor < 2.5 (if any). Indicate this/these region(s), if any, by circling its/their location(s) on the figure and labeling them as “FOS < 2.5.” Include a software applied label indicating locations of maximum and minimum values of Safety Factor.

HINT: Because the mesh generation scheme within SOLIDWORKS Simulation creates an optimized mesh, it is probable that (a) a straight line of nodes may *not* exist across the model at Section C-C, and (b) it is also *unlikely* that node points *occur exactly on a horizontal centerline through the center of curvature*. For these reasons, and to obtain the best estimate of stress on a straight line through the center of the curved section, proceed as follows.

- Zoom in on a top view of the model at section C-C.
- On the **Simulation** tab, select the **Plot Tools** icon, and from the pull-down menu click the **Probe** tool  icon. This action opens the **Probe Results** property manager.
- Open the SOLIDWORKS flyout menu, located at top left of the graphics area, and move the cursor over the **Right Plane** label. This action superimposes an edge view of the **Right Plane** onto the model. This plane will assist in locating nodes closest to a straight line at Section C-C. Unfortunately, the line disappears when the cursor is moved, but this action can be repeated while selecting nodes and can be very useful.

EXERCISE 5 – Curved Beam Stress in a Trailer Hitch (Special Topic Includes: Application of Remote Loads)

The trailer hitch shown in Fig. E2-8 is subject to both vertical and horizontal force components when towing a trailer. The vertical component, or “tongue weight” (W), is defined as the downward force due to trailer weight that acts on the hitch. For safety reasons, tongue weight should lie between 9% to 15% of the gross trailer weight (i.e., weight of the trailer plus its cargo). Towing force (F_T) is the force required to pull the trailer. Tow force is zero when the trailer is at rest; is reasonably steady when pulling a trailer at constant speed; and is maximum during acceleration or deceleration.

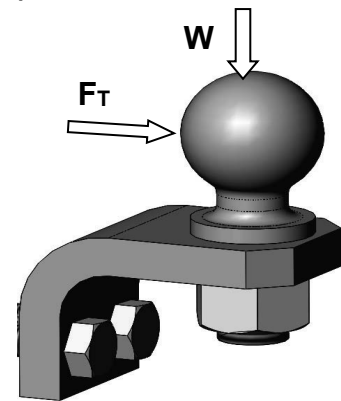

Figure E2-8 – Trailer hitch and ball assembly.

Open file: **Trailer Hitch 2-5**. A drawing of the trailer hitch, minus the ball, appears in Fig. E2-9. The hitch is bolted to a rigid frame on the towing vehicle (not shown) at the two $\frac{1}{2}$ -inch diameter holes. Because application of forces to the hitch “ball” may require abilities not yet introduced, and because stress in the ball is not the objective of this analysis, the problem can be simplified by defining applied forces using the **Remote Load/Mass** feature within SOLIDWORKS Simulation. Guidance in the application of a remote load is provided below.

Analysis of Machine Elements Using SOLIDWORKS Simulation

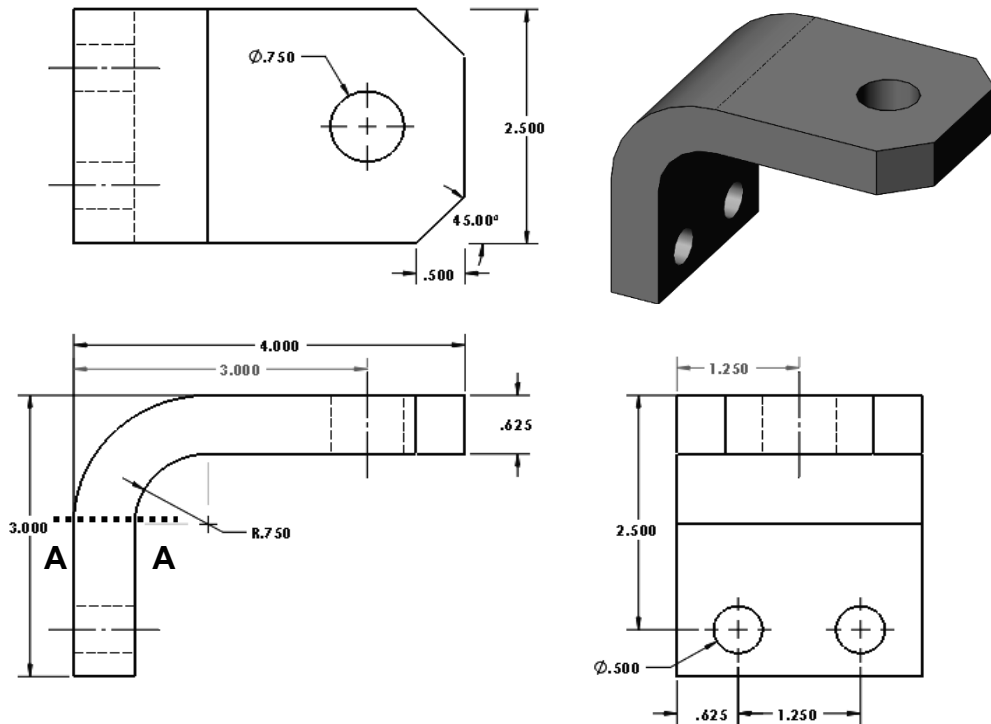

Figure E2-9 – Isolated view of the trailer hitch emphasizes its curved beam shape.

Assume the following.

- Material: **Alloy Steel** (use English units, **IPS**)
- Mesh: In the **Mesh** property manager, select **Standard mesh** and use the default mesh size.
- Fixture: To mimic bolt fasteners, apply a **Fixed** (immovable) restraint on the inside surface of the two, $\frac{1}{2}$ inch diameter bolt holes. Bolted joints are considered in Chapter 7.
- External Load: Apply force components using the **Remote Load/Mass** feature described below.
Tongue weight **W = 200 lb** (vertical downward).
Tow force **F_T = 550 lb** (horizontal) in the +X-direction.

Use of the **Remote Load/Mass** feature is described below. This feature permits application of remote forces, moments, and displacements. Remote masses are only used in cases of static, frequency, linear dynamic, or buckling studies. Application of a remote force is the only new topic introduced in this example. However, once the principle is understood, users should be able to apply it to other contexts. **Remote Load/Mass** is used primarily where modeling simplification can be realized. For example, application of force components to curved surfaces of the hitch ball can be accomplished using several methods. But, using the **Remote Load/Mass** option is one of the more direct



approaches. Also, its introduction allows this useful feature to be applied in other situations.

Solution Guidance

It is assumed that the user has opened a Simulation file and started a Study. The following instructions are to serve as a “guide”; they are less detailed than step-by-step procedures found in example problems.

Remote Load/Mass

The **Remote Load/Mass** feature can be used to replace a more complex portion of a model (or) part of the model that is not essential to the final analysis. Because this analysis focuses on stress in the curved portion of the trailer hitch, the hitch “ball” can be replaced using a **Remote Load/Mass**. When applying force components using the **Remote Load/Mass** feature, proceed as follows.

1. If a coordinate system triad is *not* visible at the bottom of the ball attachment hole, scroll to the bottom of the SOLIDWORKS manager tree and click  Coordinate System1. A “ghost” *reference coordinate system* triad is now displayed at the bottom of the “ball” hole.
2. In the Simulation manager tree right-click the  **External Loads** folder and select  **Remote Load/Mass...** This example deals only with remote “loads,” not “mass.”
3. In the **Type** dialogue box, select **Load/Mass (Rigid connection)**. This option is used when stiffness of the part to be *replaced* is significant relative to the rest of the model (the hitch “ball” is considered very stiff). **Load/Mass (Rigid connection)** is also selected because it can be applied to a **Face**, **Edge**, or **Vertices** of the part. NOTE: The **Load (Direct transfer)** option could also be used; however, it is less convenient in this case because it can only be applied to **Faces** (i.e., entire surfaces) of a model.
4. Also in the **Type** dialogue box the **Faces, Edges, or Vertices, for Remote Load/Mass** field is active (highlighted light blue). Move the cursor onto the *edge* of the “ball” hole on *top* of the hitch and click to select it. **Edge<1>** appears in the active field. This action establishes the top surface of the hitch as a reference location above which the hitch “ball” forces act.
5. In the **Reference Coordinate System** dialogue box, choose **Global** as the coordinate system *origin* from which *some* (not all) coordinates of the remote loads are defined. For example, the preceding step defined the top surface of the hitch as the position above which the horizontal “ball” force is located.

Design Insight:

The trailer hitch was intentionally designed with the **Global** coordinate system *origin* at the top of the ball hole. This location was chosen because it permits easy application of a **Remote Load/Mass** on the model as outlined below. Further, it is desired to apply forces **W** and **F_T** at the center of the ball.

Aided by the SOLIDWORKS **Sketch** in Fig. E2-10, it is seen that the center of the “ball” is located **1.616-in** above the ball shoulder. The ball center could also be located above the *reference coordinate system* origin at $X = 0$, $Y = 0.625$ (hitch thickness) + 1.616-in, and $Z = 0$. Force components **W** and **F_T** are defined in the following steps.

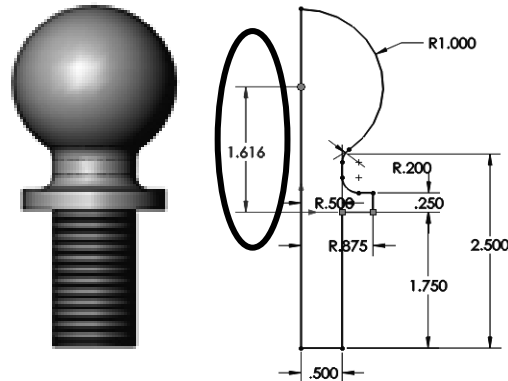

Figure E2-10 – Determination of height above the hitch surface at which forces are applied to the “ball.”

Solution Guidance (continued)

6. In the **Location** dialogue box, verify that **Unit** is set to inches **in**. Then, in the **X-Location** field, accept the zero (0) value shown. In the **Y-Location** field, type **1.616**, which is the distance above the hole edge **Global Coordinate System** selected on the top surface of the hitch. Finally, in the **Z-Location** field, accept the default zero (0) value shown.
7. If necessary, check **Force** to open the **Force** dialogue box. Verify that **Unit** is set to **lbf**. Then in the **X-Direction** field type **550**. In the **Y-Direction** field, type **200** and, if the Y-force vector is directed upward, check **Reverse Direction** because tongue weight **W** is directed downward. Finally, accept the **Z-Direction** default value of zero (0).
8. Click **[OK]** to close the **Remote Loads/Mass** property manager.

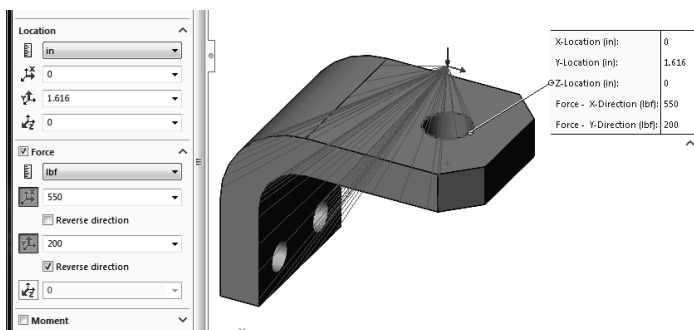

Figure E2-11 – Specifying **Location** coordinates and **Force** magnitudes in the **Remote Loads/Mass** property manager.

Determine the following:

- a. Use classical equations to compute stress at the inside (concave) surface and the outside (convex) surface of the trailer hitch model at section A-A. Section A-A passes through the center of curvature and is considered to be a horizontal line in the front view of Fig. E2-9. Include a labeled free body diagram of the portion of the model above section A-A. Use definitions provided for a rectangular cross-section model shown above Fig. 24, p. 2-20 and equations [1] and [2] on p. 2-21, or use equations from your design of machine elements textbook. Clearly label each calculation.
- b. Include an image of the hitch showing fixtures applied at the lower two bolt holes and the **Remote Load/Mass** applied above the “ball” hole.
- c. Create a stress contour plot showing the *most appropriate stress* that should be analyzed at section A-A. The *most appropriate stress* should correspond to the stress calculated in part (a).
- d. Use the **Probe** feature to determine magnitudes of the *most appropriate stress* on both the concave and convex sides of the model at section A-A. *HINT* – Display a mesh on the model. Also, to avoid edge effects, sample stress magnitudes near the middle of the model. To accurately locate the middle of the model, click the **Front** plane in the SOLIDWORKS feature manager tree or in the SOLIDWORKS flyout menu. Then rotate the model to left and right side views.

Cut-and-paste a copy of the model that includes **Probe** information flags showing stress magnitudes at the locations sampled. See Appendix A for procedures to copy SOLIDWORKS Simulation images into a Word® document.

After determining both classical and FEA results at section A-A, use equation [1] (repeated below) to compute the percent difference between these results at the concave and convex surfaces of the model.

$$\% \text{ difference} = \frac{(\text{FEA result} - \text{classical result})}{\text{FEA result}} * 100 = \quad [1]$$

- e. **QUESTIONS:** Answer the following questions on a separate page.
 - Are stress magnitudes at section A-A near the middle (on front plane) of the concave and convex sides of the trailer hitch in good agreement with stresses calculated using classical curved beam equations? (Include a definition stating what you consider to be “good agreement.”)
 - Use the **Probe** tool to explore stress magnitude on section A-A, but at increasing distances from the model center. Does stress magnitude vary as

distance from the model center increases? If stress magnitude varies, does it increase, or decrease? Is the variation of stress expected? Why?

- f. Create a plot showing Safety Factor throughout the model. On this plot include a software generated label showing the minimum Safety Factor and its location on the model.

EXERCISE 6 – Curved Beam Stress in Bicycle Caliper Brake

(Special Topic: Using a Hinge joint for Fixture)

Bicycle caliper brakes are available in many different forms. The caliper brake shown in Figs. E2-12 and E2-13 is a classic model that has been used for many years. When the brakes are operated, a pull force F_P acts on a cable attached to both halves of the brake assembly. Rubber pads apply nearly equal “squeezing” forces F_N that act normal to opposite sides of a bicycle wheel rim to stop the bike. Reaction forces F_N are shown in Fig. E2-12. In addition, frictional forces tangent to surfaces of the rubber pads are present but are ignored in this exercise.

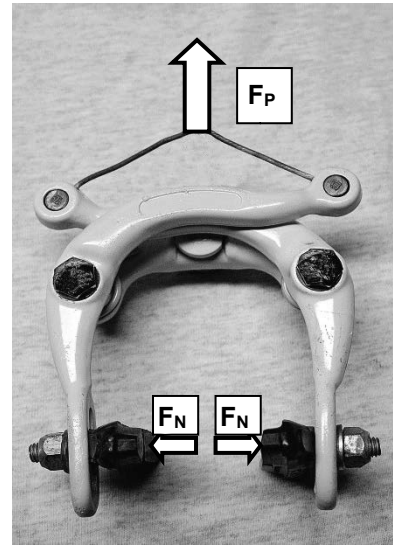

Figure E2-12 – Actual caliper brake showing applied pull force F_P and reaction forces F_N .

Open file: Bicycle Caliper Assembly

A dimensioned view of one-half of the brake caliper model is shown in Fig. E2-13. During intense braking a maximum vertical pull force of $F_P = 246$ N is applied to the small diameter cable midway between its attachment points on each half of the caliper as shown in Fig. E2-12. The brake caliper rotates freely about a fixed pivot located at the 6 mm diameter hole at **A**.

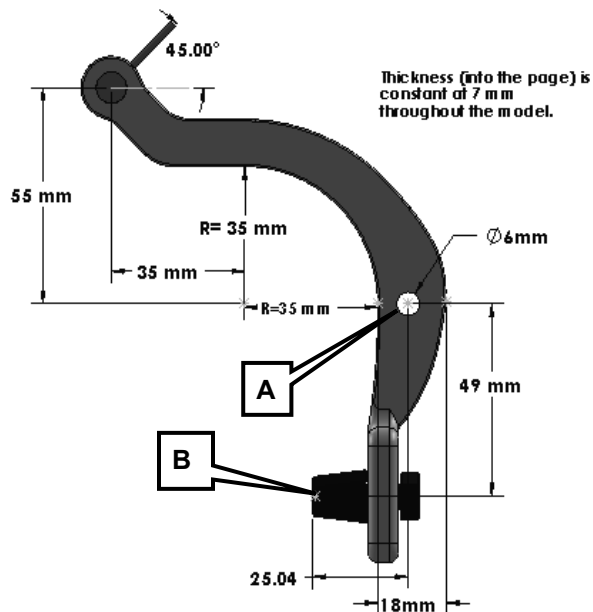

Figure E2-13 – Front view showing basic geometry of the bicycle caliper brake.

Create a finite element model of this part that includes material specification, fixtures, external loads, mesh, solution and results analysis.

- Material: Bicycle Brake Pad-1 - **Natural Rubber** (Use SI units)
Bicycle Brake Wire-1 – **AISI 347 Annealed Stainless Steel (SS)**
Bicycle Caliper-1 – Aluminum Alloy **2014 Alloy**
- Mesh: Use the system default size **Standard Mesh**. *Due to model complexity do NOT defeature this model prior to meshing.*
- Fixture: Apply a **Fixed Hinge** at hole **A**. Refer to the **Solution Guidance** text box in the section titled **Fixed Hinge Specification** near the bottom of page 2-44 and forward.
Also, apply an appropriate user specified **Fixture** to the brake pad surface at **B**.
- External Load: Compute the external load applied to the right half of the caliper brake. NOTE: The horizontal radius of curvature, shown as **R=35 mm**, is dimensioned from the center of curvature to the *inside* edge of the caliper arm. The caliper arm is 18 mm wide at the location of hole **A** (see bottom dimension in Fig. E2-13).

Special Solution Note:

Due to specification of a **Fixed Hinge** on this model, it is highly likely that the following warning message will appear during the **Solution** portion of this analysis.

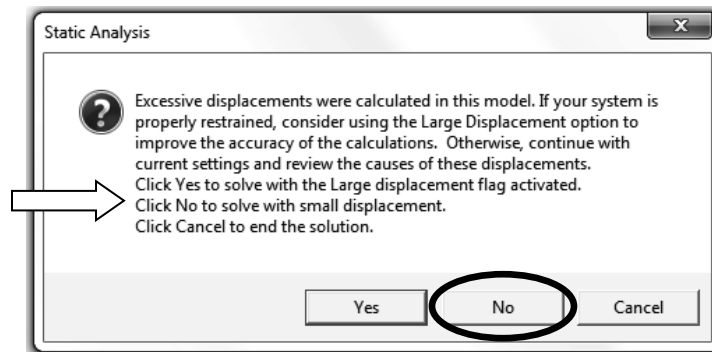

Click the [**No**] button if the above **Static Analysis** window appears and continue with the “small displacement” Solution.

ASIDE:

Why can this large displacement be ignored? Parts anchored by a **Fixed Hinge** are likely to rotate freely about the hinge when under load. Although these rotations may be very small, they are *relatively* large in comparison to part distortion (displacement) caused by the applied loads. Consider using a **Large displacement** solution when significant part distortion occurs due to applied loads.

Determine the following:

- a. Use classical equations to compute stress at the inside and outside surfaces of the brake caliper on a horizontal section through the caliper at hole **A**. The following assumptions apply at this location: the caliper is rectangular in shape and is 7 mm thick (dimension into the page); radius of curvature to the inside (concave) surface is 35 mm and radius of curvature to the outer surface is 35 mm + 18 mm = 53 mm; these radii are considered constant for a sufficient distance above and below the hole so as not to affect calculations; the hole is to be neglected in stress calculations. Clearly label stress calculations at the inside and outside surfaces. Include a free body diagram of the upper portion of the caliper; label all forces and reactions acting on this body.
- b. Use the **Probe** feature to produce a graph of the *most appropriate stress* on a horizontal section through the caliper at point **A**. Begin sampling values at the inside (concave) surface and continue to the outside (convex) surface; proceed along the straightest line possible. Use the **Stress Plot** property manager to specify the *appropriate stress* for this plot to enable comparison with manual calculations of part (a). Include a descriptive title, axis labels, and your name on this graph. Ignore the line segment connecting stresses *across* hole **A**.

Beneath this graph, cut-and-paste a copy of the model that includes **Probe** information flags showing stress magnitudes at the locations sampled on its concave and convex sides only. See Appendix A for procedures to copy SOLIDWORKS Simulation images into a Word® document.

After determining both classical and FEA results at section **A**, use equation [1] (repeated below) to compute the percent difference between these results at the concave and convex surfaces of the model.

$$\% \text{ difference} = \frac{(\text{FEA result} - \text{classical result})}{\text{FEA result}} * 100 = \quad [1]$$

- c. Create a stress contour plot of von Mises stress in the caliper. Include automatic labeling of maximum and minimum stress on this plot. Cut and paste this plot on the top half of an 8 ½ x 11 sheet.
- d. Assuming the caliper is made of a ductile material, produce a plot showing regions where the safety factor < 2.0. Cut and paste this plot on the page beneath the von Mises plot of part (c) above. Also, if the safety factor is < 1.0 at any location within the caliper, produce a second plot to highlight any un-safe region(s). Manually label region(s), if any, where safety factor < 1.0 and paste the image adjacent to that showing regions where safety factor < 2.0.
- e. Determine the **Result Force** acting on the flat face of the rubber brake pad. On a separate page, cut and paste a copy of the entire **Result Force** property manager;

include the **Reaction Force** table. In the same “screen shot,” include the caliper assembly adjacent to the **Result Force** property manager. Adjacent to these images, draw a free body diagram of the caliper assembly. Label all known and unknown forces, and pertinent dimensions on this drawing. Then, in the remaining space manually calculate the reaction force(s) acting on the brake pad. Compare reaction force components in the X, Y, and Z directions with those determined from manual calculations. Use equation [1] to determine the percent difference between manual calculations and FEA results.

- f. Beneath the “Fixture:” heading of the exercise statement, you were instructed to “*apply an appropriate user specified **Fixture** to the brake pad surface at **B**.*” In a few sentences, name the type of **Fixture** you specified at **B** and discuss the reason(s) why that **Fixture** was selected as appropriate.
- g. Stress concentrations are typically associated with geometric discontinuities, such as the hole at **A**. Zoom in on hole **A** in the von Mises stress plot and examine stress magnitudes by comparing them to the color-coded stress legend. Use the **Probe** tool to search various areas around the hole and record the maximum stress at that location. Finally, discuss why or why not the hole at **A** results in higher stress.

Textbook Problems

It is highly recommended that the above exercises be supplemented by problems from a design of machine elements textbook. A great way to discover errors made in formulating a finite element analysis is to work problems for which the solution is known by independent calculation or experiment. Typical textbook problems, if well defined in advance, make an excellent source of solutions for comparison.

NOTES:
