

Printed
in Full Color

Finite Element Simulations

with ANSYS® Workbench 2020

Theory, Applications, Case Studies

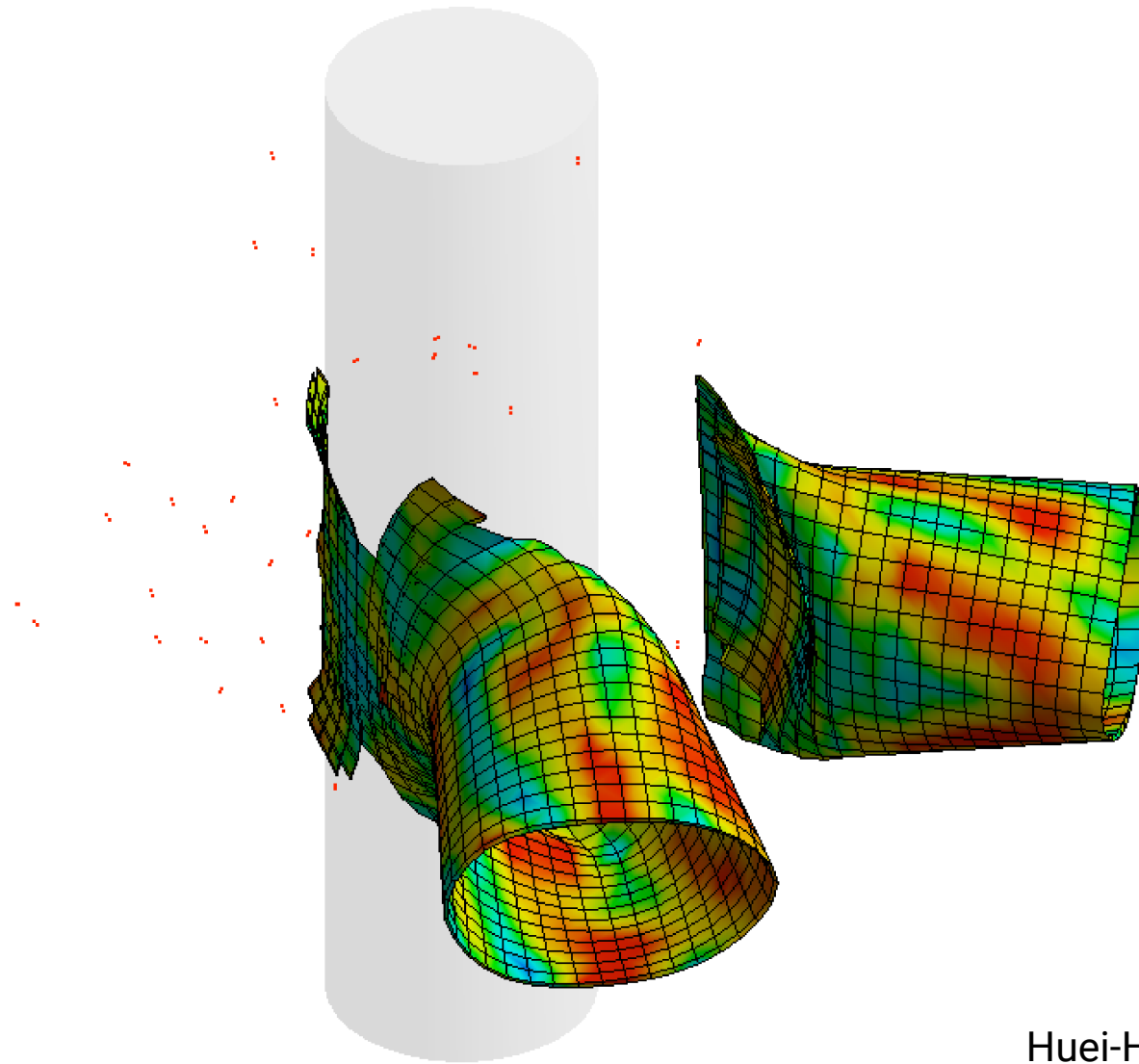

Huei-Huang Lee



Better Textbooks. Lower Prices.
www.SDCpublications.com



ACCESS CODE
UNIQUE CODE INSIDE

Visit the following websites to learn more about this book:



[amazon.com](https://www.amazon.com)

[Google books](https://books.google.com)

[BARNES & NOBLE](https://www.barnesandnoble.com)

Chapter 2

Sketching

A 3D geometry can be viewed as a series of adding/removing material of simple solid bodies. Each solid body is often created by first drawing a 2D sketch, called a profile, and then extruding/revolving/sweeping the profile to generate the 3D solid body.

Purpose of This Chapter

This chapter provides exercises for the students so that they know how to draw 2D sketches using an ANSYS Workbench's geometry editor, DesignModeler. The profiles of several mechanical parts will be sketched in this chapter, and each sketch is then used to generate a mechanical part using a 3D modeling tool such as **Extrude** or **Revolve**. The use of these 3D modeling tools is trivial so that we may focus on 2D sketching techniques. More sophisticated use of 3D modeling tools will be introduced in Chapter 4.

About Each Section

Each mechanical part will be completed in a section. Section 2.1 sketches a cross section of W16x50; the cross section is then extruded to become a 3D beam. Section 2.2 sketches a triangular plate; the sketch is then extruded to become a 3D plate. Section 2.3 does not provide a hands-on case; rather, it overviews the sketching tools in a systematic way, attempting to complement what was missed in the first two sections. Sections 2.4, 2.5, and 2.6 provide three additional exercises, in which we purposely leave out some steps for the students to figure out the details themselves.

Section 2.1

W16x50 Beam

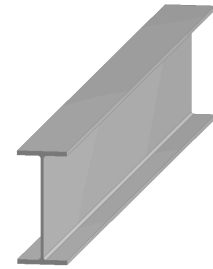

2.1.1 About the W16x50 Beam

[1] In this section, we will create a W16x50 steel beam (see [2-5]). The beam has a length of 10 ft. ✓

[2] Wide-flange I-shape section. →

[3] Nominal depth 16 in. →

[4] Weight 50 lb/ft. →

[5] W16x50 cross section. #

W16x50

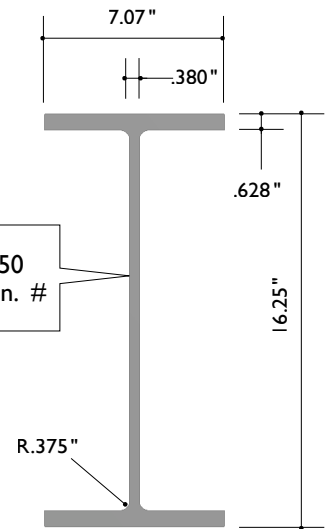

2.1.2 Start Up DesignModeler

[2] Workbench GUI appears. ✓



[1] Launch Workbench. ✓

[3] Click the plus sign (+) to expand **Component Systems**; the plus sign becomes a minus sign (-). →

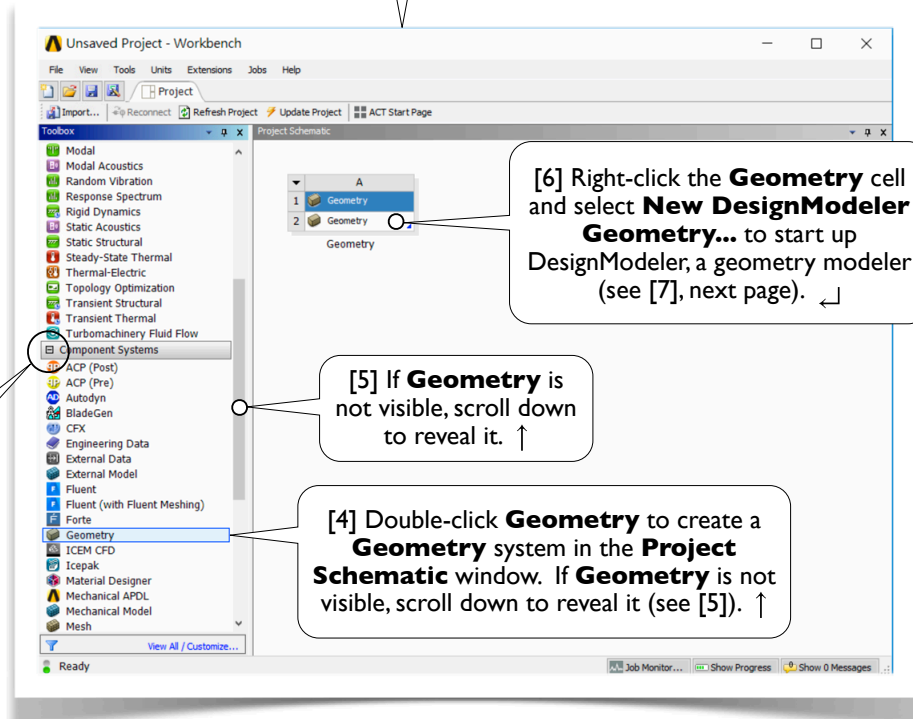

[6] Right-click the **Geometry** cell and select **New DesignModeler Geometry...** to start up DesignModeler, a geometry modeler (see [7], next page). ↵

[5] If **Geometry** is not visible, scroll down to reveal it. ↑

[4] Double-click **Geometry** to create a **Geometry** system in the **Project Schematic** window. If **Geometry** is not visible, scroll down to reveal it (see [5]). ↑

DesignModeler vs. SpaceClaim

[7] As mentioned in 1.1.4[2], page 13, Workbench provides two geometric modelers: **DesignModeler** and **SpaceClaim**. Until ANSYS 15, **DesignModeler** was the only modeler provided by Workbench. For simple and small models, **DesignModeler** serves well enough; but for complicated and large models, the engineers often create a geometric model using a CAD software such as SOLIDWORKS, PTC Creo, Autodesk Inventor, etc., and then import the model to Workbench. In ANSYS 16 and 17, **SpaceClaim** was included in Workbench as an alternative modeler, and **DesignModeler** remained as the default modeler. Starting from ANSYS 18, **SpaceClaim** becomes the default modeler, and **DesignModeler** serves as an alternative modeler.

In this book, since all the geometric models are simple and small, we will use **DesignModeler** to create the geometric models. Remember, the focus of this book is the finite element simulations, not the geometric modeling. ✓

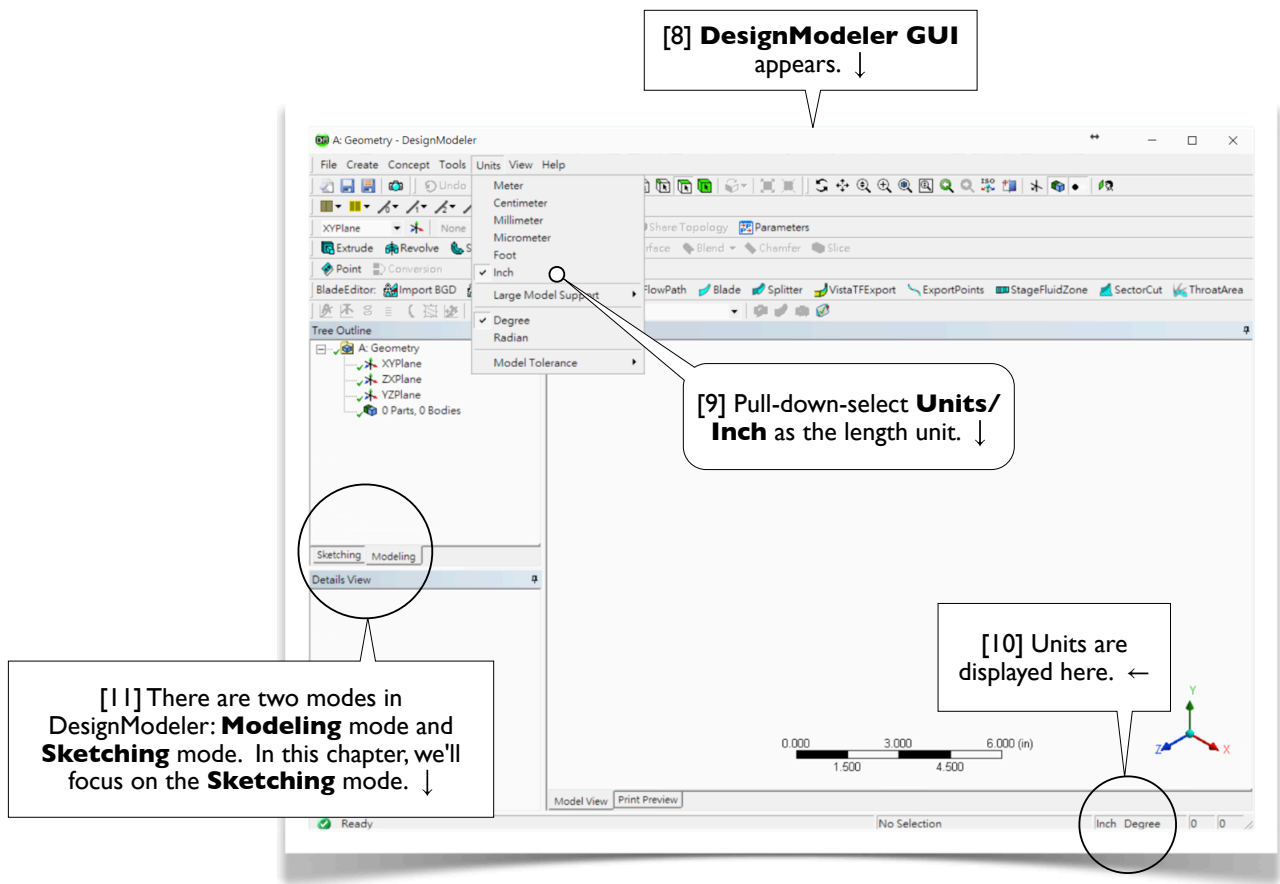

About Textboxes

[12] In this book, a round-cornered textbox (e.g., [1, 3-6, 9]) is used to indicate that mouse or keyboard ACTIONS are needed in that step. A sharp-cornered textbox (e.g., [2, 7-8, 10-11]) is used for explanations only; no mouse or keyboard actions are needed in that step. #

2.1.3 Draw a Rectangle on **XYPlane**

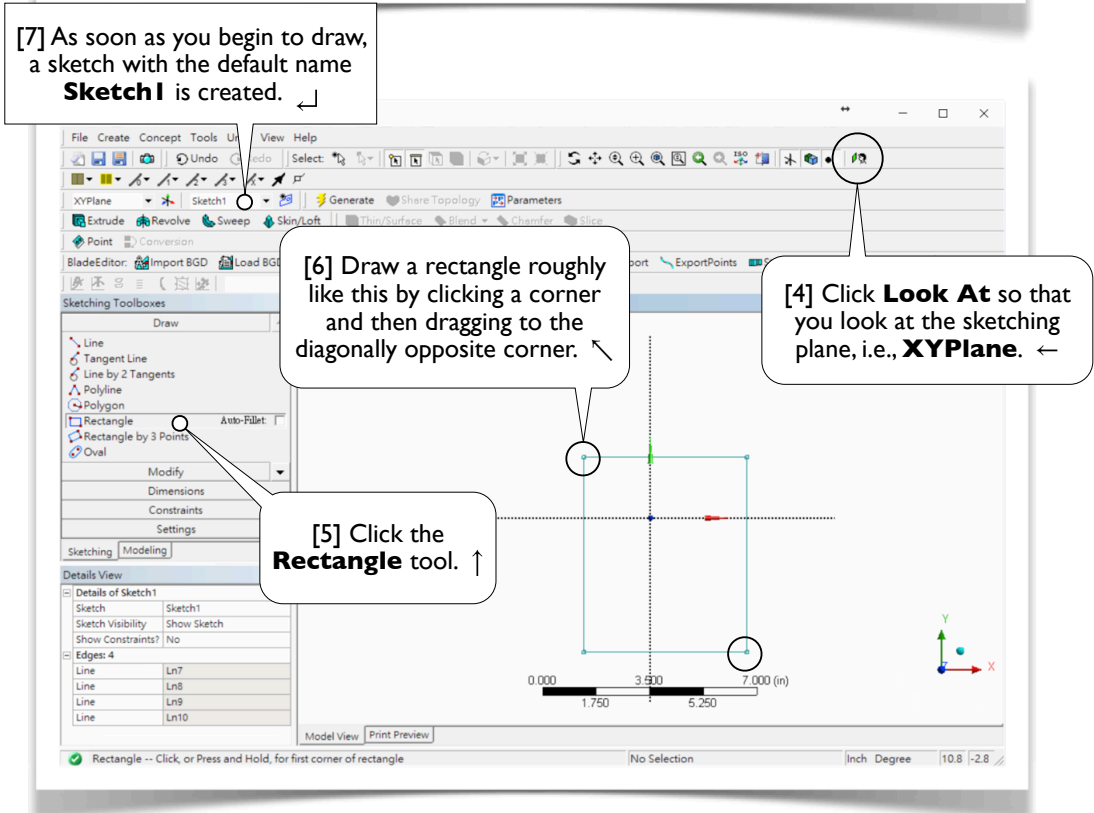
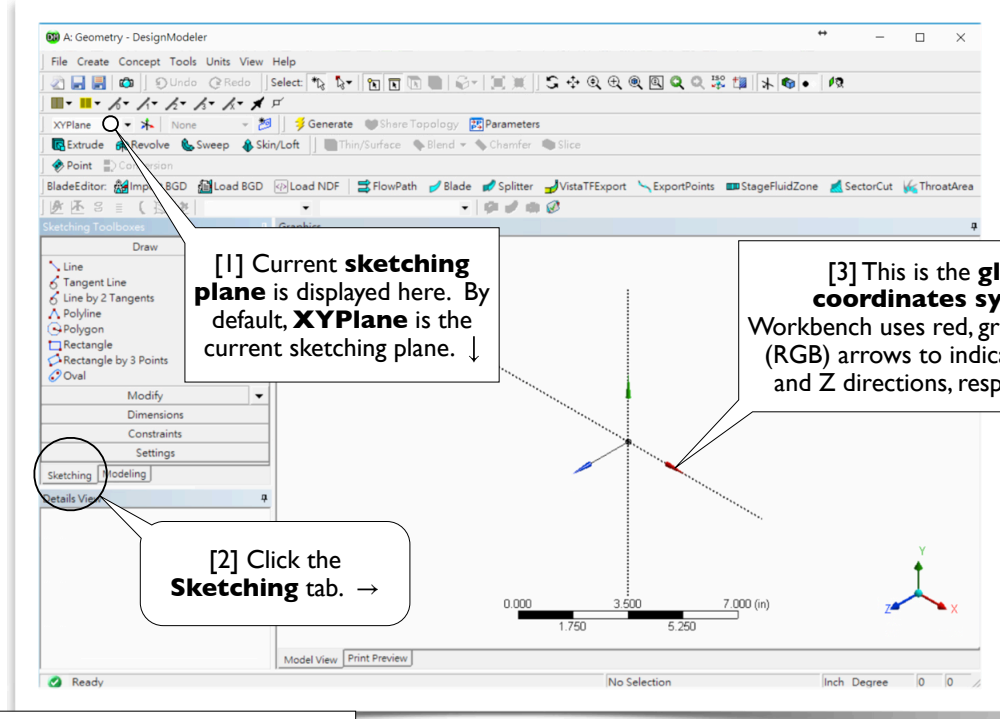

[8] Click the **Constraints** toolbox. We want to impose symmetry constraints. ↓

[12] Right-click anywhere on the graphic area to open a context menu, and choose **Select new symmetry axis**. ↓

[10] Click the **Symmetry** tool. ↓

[9] If the **Symmetry** tool is not visible, click to scroll down until you see the tool. ↑

[13] Click the horizontal axis and then the two horizontal lines to make the two lines symmetric about the horizontal axis. ✓

[11] Click the vertical axis and then the two vertical lines; this makes the two lines symmetric about the vertical axis. ↑

[20] Click **Zoom to Fit**. #

[14] Click the **Dimensions** toolbox. ↓

[16] Click this line, move the mouse upward, and click again to create H1. ↓

[17] Click this line, move the mouse rightward, and click again to create V2. ↓

[15] **General** is the default tool, providing smart dimensioning capabilities. ↗

[18] All the lines turn to blue color. Colors are used to indicate **constraint status**. The blue color means the geometric entities are well-defined, i.e., fixed in the space. ←

[19] In **Details View**, type 7.07 (in) for H1 and 16.25 (in) for V2. ↑

2.1.4 Set Up Sketching Options

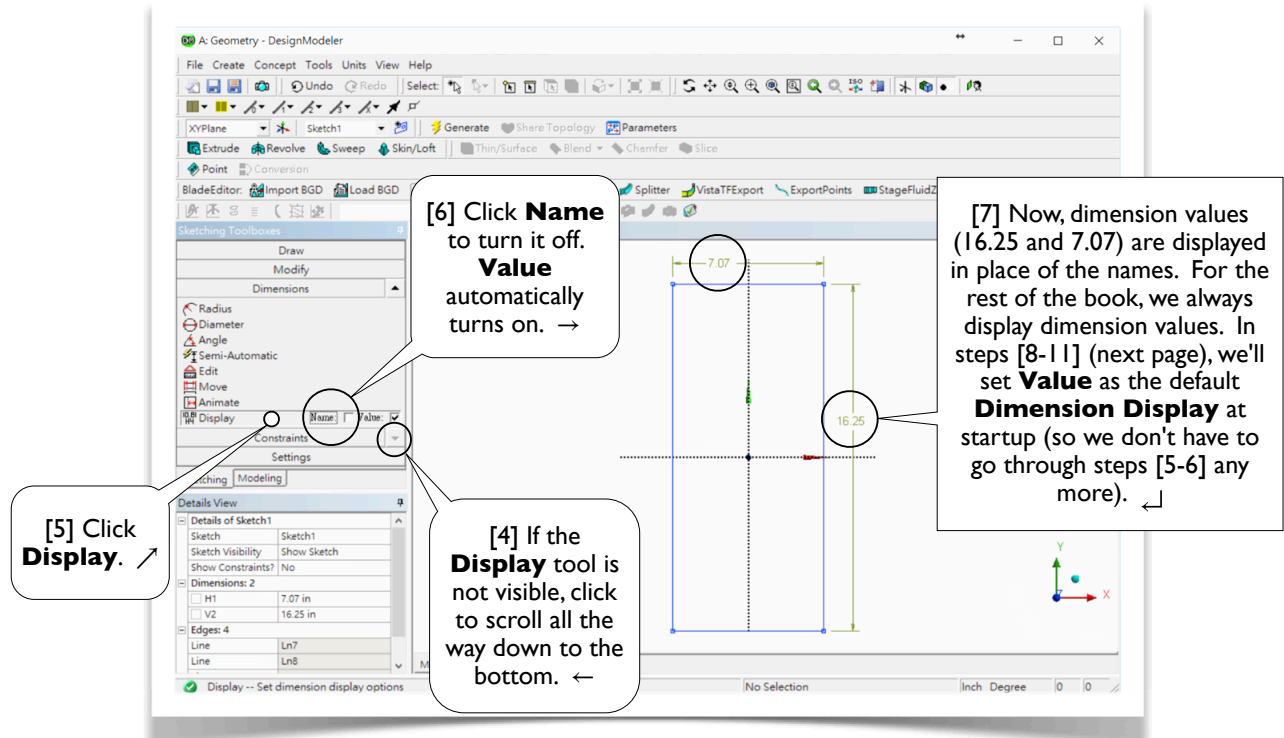
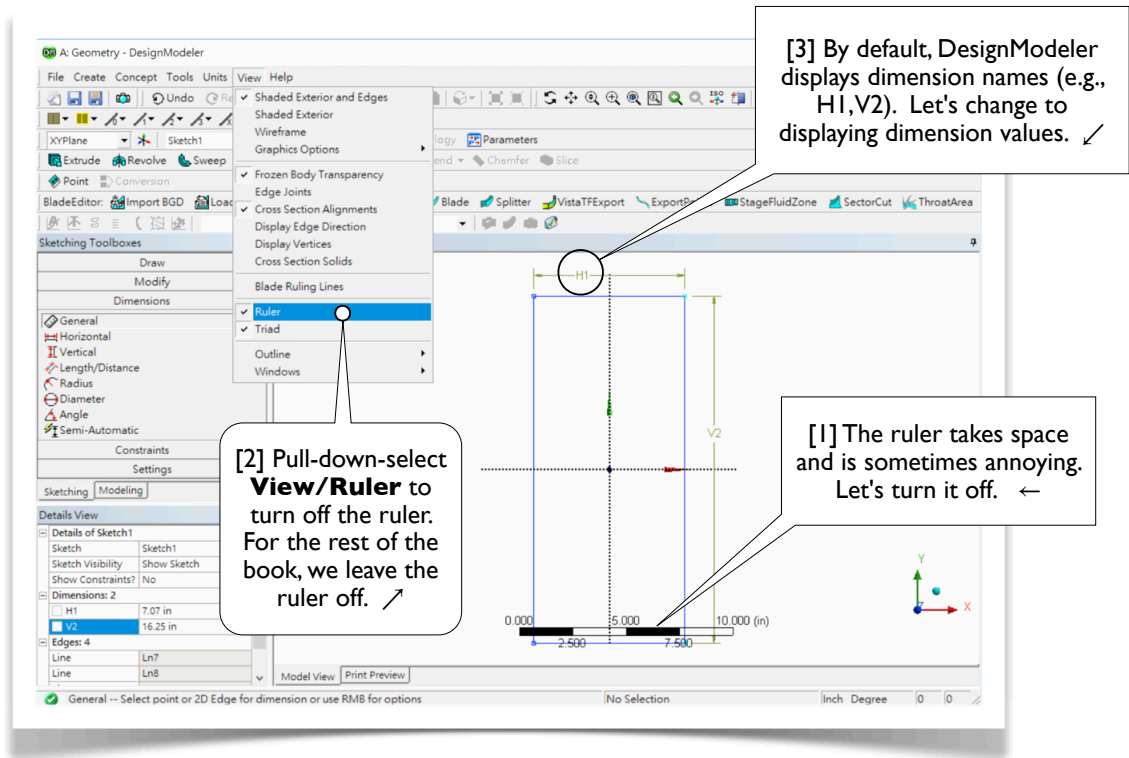

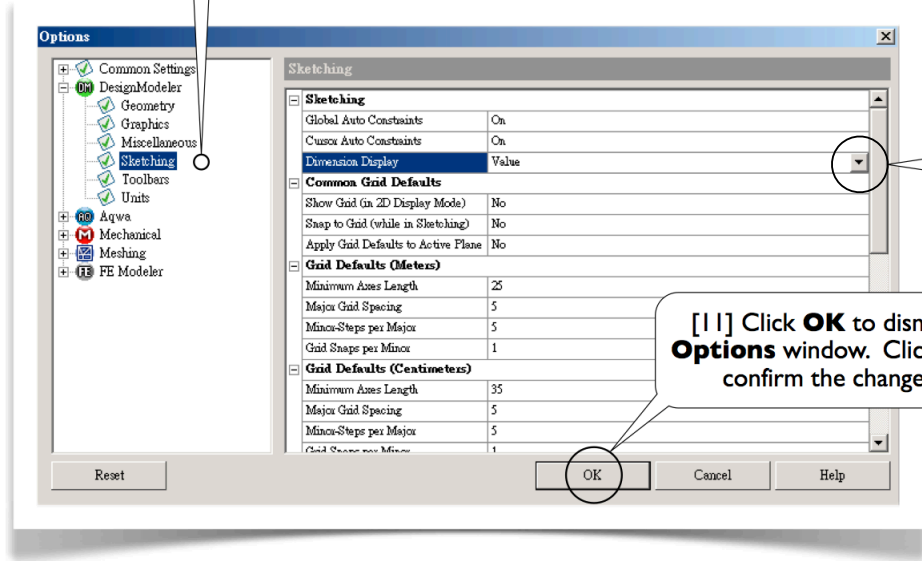
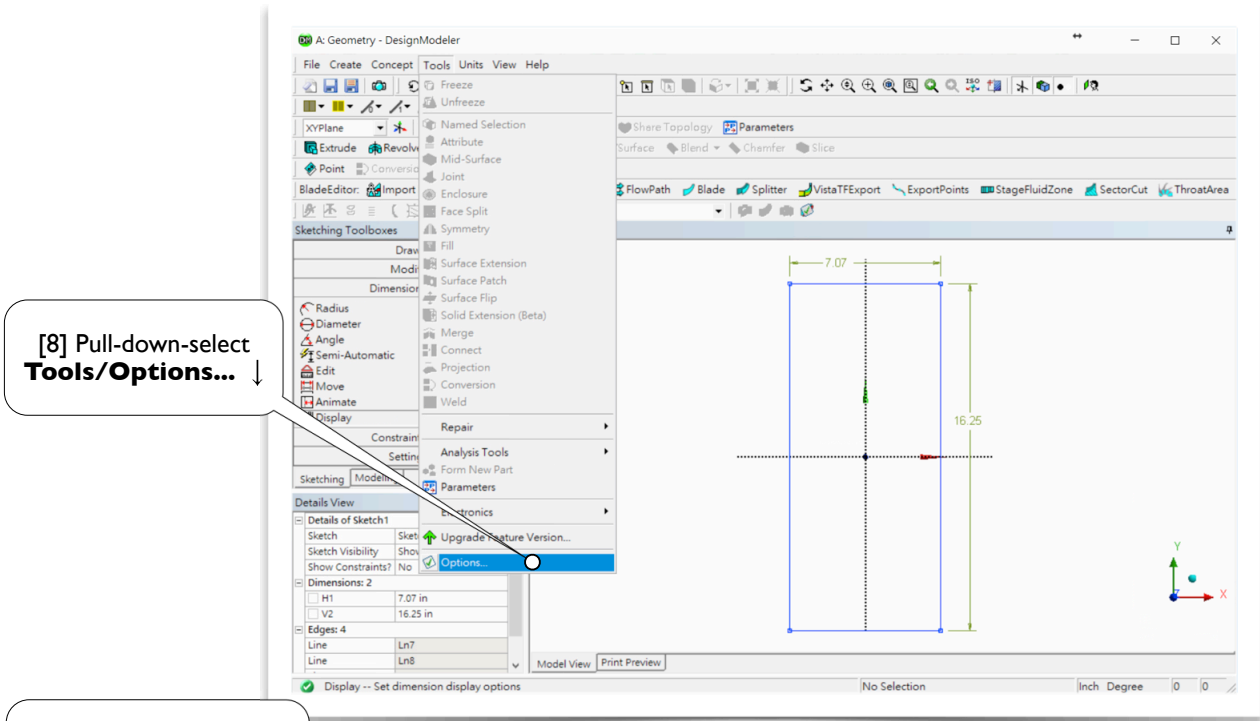

Background Color of the Graphic Area

[12] In this book, for better readability, the background color of the graphic area is always shown in white. To set up the background color, pull-down-select **Tools/Options** in **Workbench GUI** (2.1.2[2], page 57; not **DesignModeler GUI**, 2.1.2[8], page 58) and select **Appearance.** #

2.1.5 Draw a Polyline

[1] Select the **Draw** toolbox.

[2] Select the **Polyline** tool. ↓

[3] Click roughly here to start a polyline. Before clicking, make sure a **C** (coincident) appears. →

[4] Click the second point roughly here. Before clicking, make sure a **C** and an **H** (horizontal) appear. ↓

[5] Click the third point roughly here. Before clicking, make sure a **V** (vertical) appears. ←

[6] Click the fourth point roughly here. Before clicking, make sure an **H** and a **C** appear. ↗

[7] Right-click anywhere on the graphic window to open a context menu, and select **Open End** to end the **Polyline** tool and leave the polyline open. #

2.1.6 Copy the Polyline

[1] Select the **Modify** toolbox. ↓

[2] Select the **Copy** tool. ↓

[3] Select the three newly created segments by clicking one after another. ↗

[4] Right-click anywhere on the graphic window, and select **End/Use Plane Origin as Handle**. ↙

[5] The **Paste** tool is automatically activated. →

[6] Right-click-select **Flip Horizontal**. ↓

[7] Right-click-select **Paste at Plane Origin**. ✓

[8] Right-click-select **End** to end the **Paste** tool. An alternative way (which is a more convenient way) is to press **ESC** to end a tool. #

2.1.7 Basic Mouse Operations in Sketching Mode

[1] Now, try these basic mouse operations in the sketching mode [2-7]. Press **ESC** to deselect all entities. After trying any of [5-7], click **Zoom to Fit** (2.1.3[20], page 60) or **Look At** (2.1.3[4], page 59) to display a fitting view. ✓

[2] **Click**: add a sketching entity to the selection set. Click a selected entity to remove it from the selection set. ↓

[3] **Click-Sweep**: continuous selection. →

[4] **Right-click**: open a context menu. ↑

[5] **Right-click-drag**: box zoom. ↑

[6] **Scroll-wheel**: zoom in/out. ←

[7] **Middle-click-drag**: rotate.
Shift-middle-click-drag: zoom.
Control-middle-click-drag: pan. #

2.1.8 Trim Away Unwanted Segments

[1] Select the **Trim** tool in the **Modify** toolbox. ↑

[2] Turn on **Ignore Axis**. Without turning it on, the axes would act as trimming tools. ↓

[3] Click to trim this segment. →

[4] And click to trim this segment. #

2.1.9 Impose Symmetry Constraints

[1] Select the **Constraints** toolbox. ↓

[2] Select **Symmetry**. ↓

[3] Click the horizontal axis and then two horizontal segments on both sides as shown to make the two segments symmetric about the horizontal axis. ↗

[4] Right-click-select **Select new symmetry axis**. ↓

[5] Click the vertical axis and then two vertical segments on both sides as shown to make the two segments symmetric about the vertical axis. Although they seem already symmetric before we impose the constraint, the symmetry was "weak;" i.e., they may be overridden by other constraints. Now, the symmetry is "strong" and cannot be overridden. #

2.1.10 Specify Dimensions

[1] Select the **Dimensions** toolbox. ↓

[2] **General** is the default tool. ↓

[5] Select **Horizontal** (to specify a horizontal dimension). ↓

[3] Click this vertical segment and move leftward to create a dimension (in the details view [4], the corresponding name is V3). ↓

[7] In **Details View**, type 0.38 (in) for H4. ↘

[4] In **Details View**, type 0.628 (in) for V3. ↑

[6] Click these two vertical segments one after the other and move upward to create a horizontal dimension (H4). ↙

[8] All the sketching entities are blue-colored, meaning that they are well-defined, i.e., fixed in the space. #

Details of Sketch1	
Sketch	Sketch1
Sketch Visibility	Show Sketch
Show Constraints?	No
Dimensions: 4	
<input type="checkbox"/> H1	7.07 in
<input type="checkbox"/> H4	0.38 in
<input type="checkbox"/> V2	16.25 in
<input type="checkbox"/> V3	0.628 in

2.1.11 Add Fillets

[1] Select the **Modify** toolbox. ←

[2] Select the **Fillet** tool. →

[3] Type 0.375 (in) for **Radius**. ↓

[4] Click these two segments to create a fillet. Repeat this step for the other three concave corners. →

[5] The greenish-blue color of the fillets indicates that these fillets are under-constrained. The radius specified in [3] is a "weak" dimension (may be overridden by other constraints). We could specify a **Radius** dimension (in the **Dimensions** toolbox) to turn the fillets blue. However, we decide to ignore the color. We want to demonstrate that an under-constrained sketch can still be used. Remember, however, it is a good practice to make all entities blue-colored. #

2.1.12 Move Dimensions

[1] Select the **Dimensions** toolbox. ↘

[2] Select **Move**. →

[3] Select a dimension value and move it to an appropriate position. Repeat this for other dimensions. Scroll the mouse wheel (or shift-middle-click-drag) to zoom in/out (2.1.7[6-7], page 64) whenever necessary. ↙

[4] Click **Zoom to Fit** whenever necessary. #

2.1.13 Generate a 3D Solid Body

[3] Remember that the active sketch is shown here (2.1.3[7], page 59). ✓

[8] Click **Generate**. ↓

[4] Click **Extrude**. →

[5] The **Modeling** mode is automatically activated. ↓

[6] Click **Apply**. By default, the active sketch [3] is selected as **Geometry**. ↓

[7] Type 120 (in) for **Depth**. ↑

[1] Click the little cyan sphere to rotate the view to an isometric view, which is a convenient 3D view. ✓

[2] The view rotates to an isometric view. ↘

[9] Click **Zoom to Fit**. Feel free to use this tool any time. →

[10] Click **Display Plane** to turn off the display of the sketching plane. ✓

[11] Click all the plus signs (+) to expand the **model tree** and browse its structure. #

2.1.14 Save Project and Exit Workbench

[1] Pull-down-select **File/ Close DesignModeler**. ↓

[2] Click **Save Project** and type **W16x50** as the project name. ↘

[3] Pull-down-select **File/ Exit** to exit Workbench. ←

[4] A file **W16x50** and a folder **W16x50_files** are created in your working folder. Double-clicking **W16x50** would open the project again. ↓

The screenshots show the following steps:

- Opening the **File** menu and selecting **Close DesignModeler**.
- Clicking **Save Project** in the **File** menu and entering **W16x50** as the project name.
- Opening the **File** menu and selecting **Exit**.
- Viewing the **W16x50 - Workbench** interface, where the project has been saved. A callout box indicates that a folder **W16x50_files** and a file **W16x50** are created in the working folder.

Supporting Files

[5] To download the finished project files or view the demo videos, please visit SDC Publications' website or the author's webpage. See Access Code and Author's Webpage in **Preface** (page 7) for details. #

Section 2.2

Triangular Plate

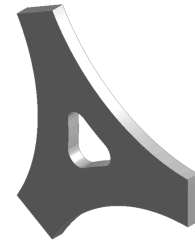

2.2.1 About the Triangular Plate

[1] A triangular plate [2-3], with a thickness of 10 mm, is used to withstand tensile forces on its three side faces [4].

In this section, we'll sketch a profile of the plate on **XYPlane** and then extrude the profile a thickness of 10 mm along Z-axis to generate a 3D solid body.

In Section 3.1, we will use this sketch again to generate a 2D solid model, which is then used for a static structural simulation to assess the stress under the tensile forces.

The 2D solid model will be used again in Section 8.2 to demonstrate a design optimization procedure. →

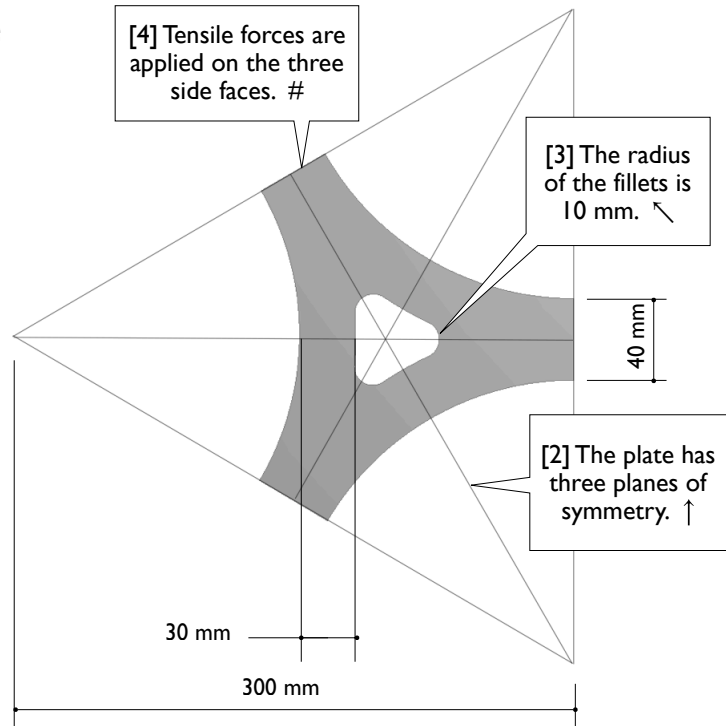

2.2.2 Start up DesignModeler

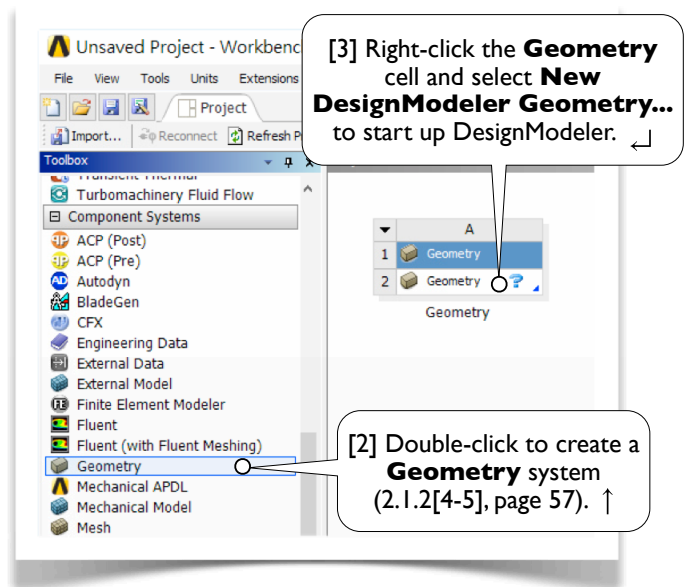
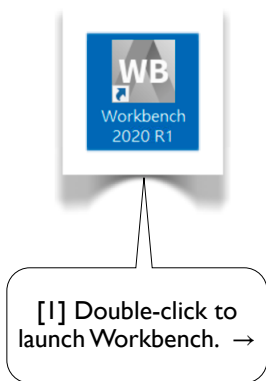

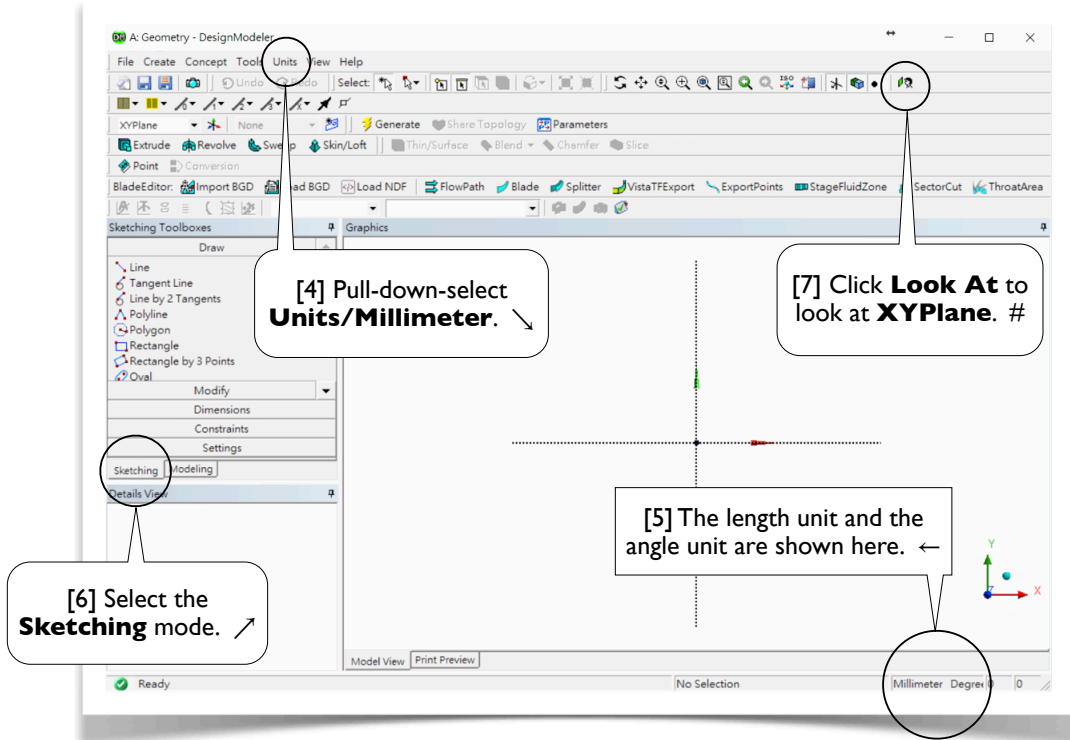

2.2.3 Draw a Triangle on XYPlane

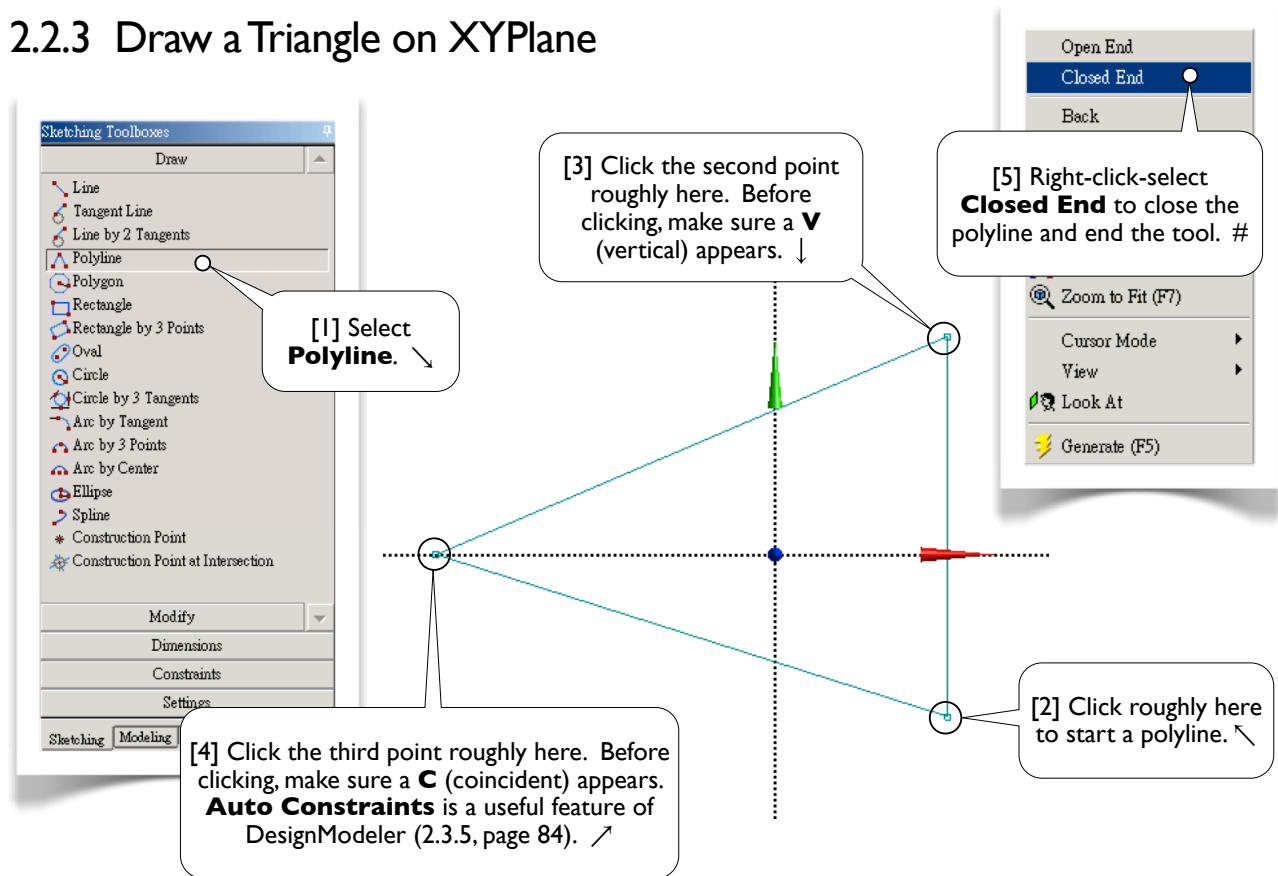

2.2.4 Make the Triangle Regular

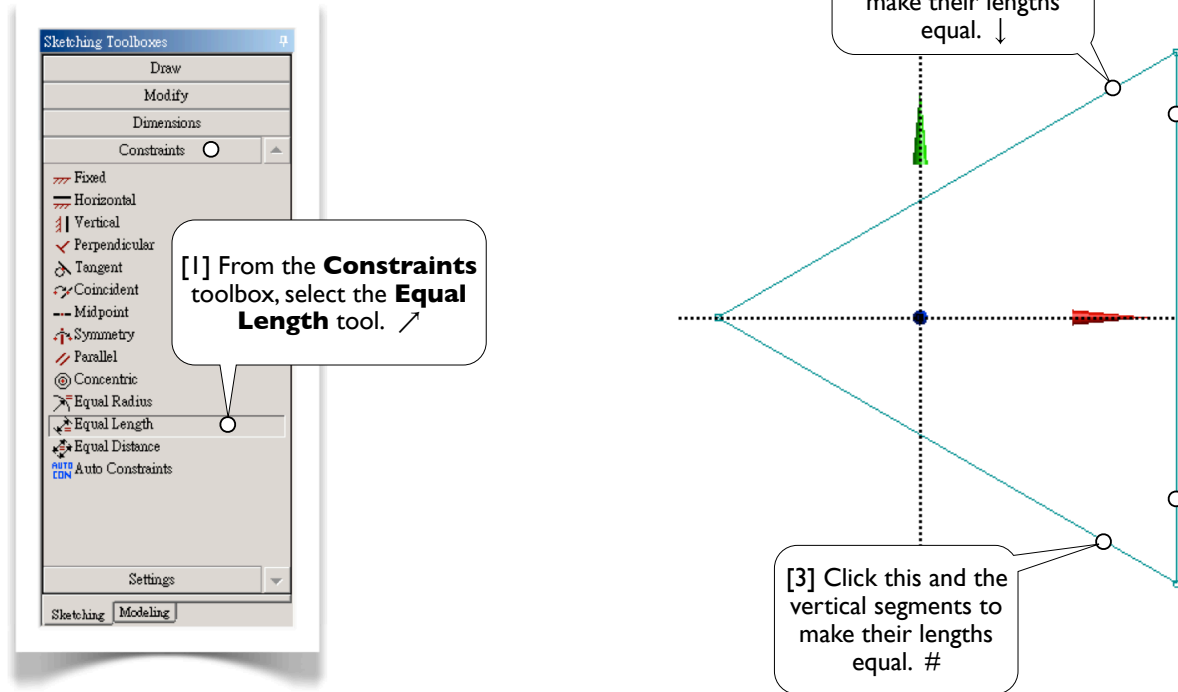

2.2.5 2D Graphics Controls

[1] Tools for 2D graphics controls are available in the **Display Toolbar** [2-10]. Click the tools in [4-6] to toggle them on/off. Feel free to use these tools any time. Try to click each tool now; they don't modify the model. Note that other ways to **Pan**, **Zoom**, and **Box Zoom** are given in 2.1.7[5-7] (page 64) and 2.3.4[1] (page 83). ↓

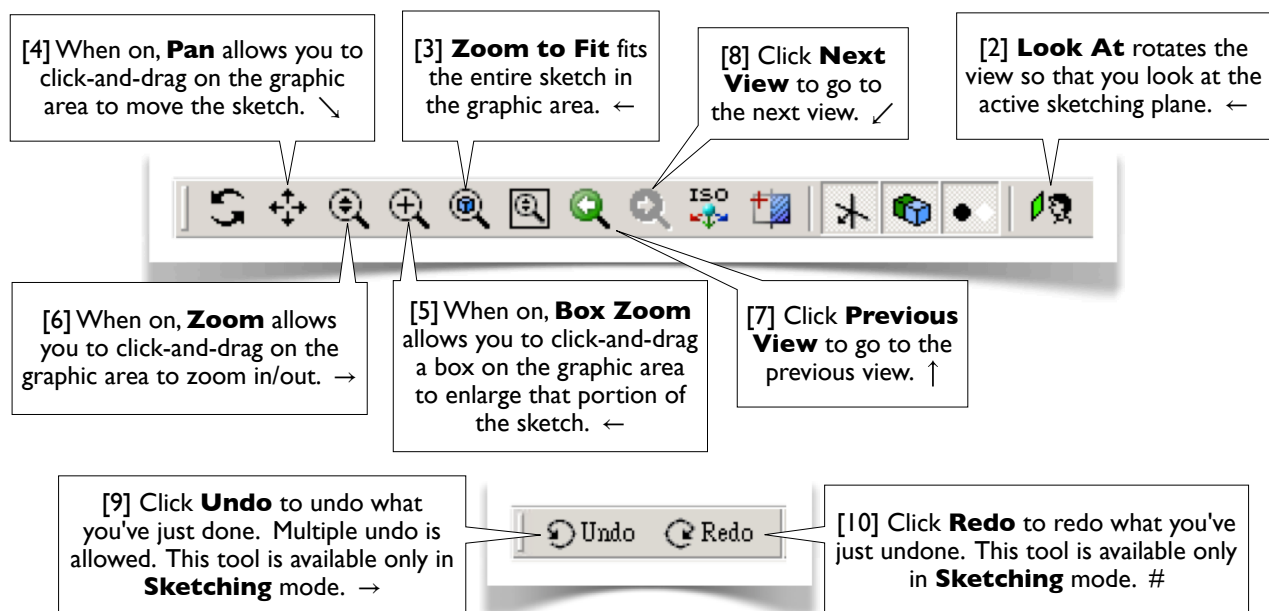

2.2.6 Specify Dimensions

[1] From the **Dimension** toolbox, select **Horizontal**.

[5] Select **Move** and move the dimensions to appropriate positions (2.1.12[2-3], page 67). #

Details View	
Details of Sketch1	
Sketch	Sketch1
Sketch Visibility	Show Sketch
Show Constraints?	No
Dimensions: 2	
<input type="checkbox"/> H1	300 mm
<input type="checkbox"/> H2	200 mm

[4] In **Details View**, type 300 (mm) and 200 (mm) for the dimensions just created. Click **Zoom to Fit** (2.2.5[3], last page). ✓

2.2.7 Draw an Arc

[1] From the **Draw** toolbox, select **Arc by Center**. →

[2] Click this vertex as the arc center. Before clicking, make sure a **P** (point) constraint appears. ←

[3] Click the second point roughly here. Before clicking, make sure a **C** (coincident) constraint appears. ↘

[4] Click the third point here. Before clicking, make sure a **C** (coincident) constraint appears. #

2.2.8 Replicate the Arc

[1] From the **Modify** toolbox, select **Replicate**. Type 120 (degrees) for **r** (rotate). **Replicate** is equivalent to **Copy+Paste** (2.1.6[2, 5], pages 63-64). ↘

[2] Select the arc. →

[3] Right-click-select **End/Set Paste Handle**. ↙

[4] Select this vertex as paste handle. Before clicking, make sure a **P** (point) appears. ✓

[5, 9] Right-click-select **Rotate by r** from the context menu. ↓ ↵

[6] Click this vertex to paste the arc. Before clicking, make sure a **P** appears. If you have difficulty making **P** appear, see [7-8]. →

[7] Whenever you have difficulty making **P** appear, click **Selection Filter: Points** in the toolbar. **Selection Filter** is also available in the context menu (see [8]). ↑

[8] **Selection Filter** is also available in the context menu. ✓

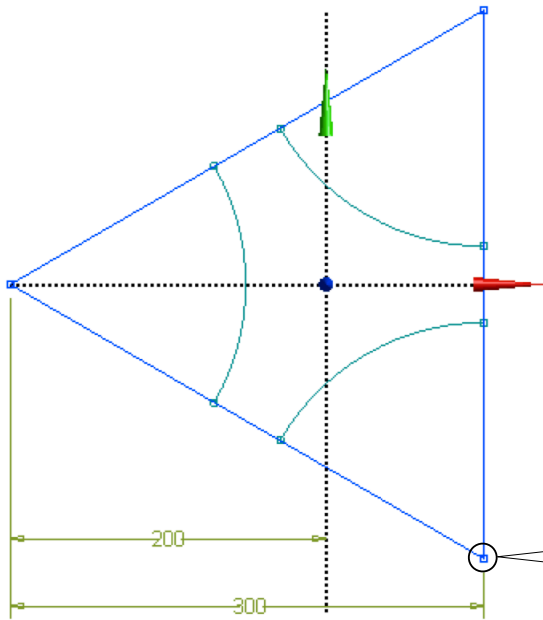

[10] Select this vertex to paste the arc. Before clicking, make sure a **P** appears. →

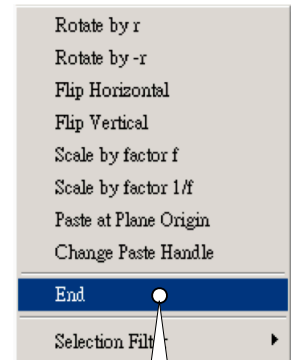

[11] Right-click-select **End** in the context menu to end the **Replicate** tool. Alternatively, press **ESC** to end the tool. ✓

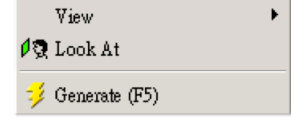

[12] We chose to manually set the paste handle at a vertex ([3-4], last page) because we want to demonstrate the use of **Set Paste Handle** [3]. In this case, select **Use Plane Origin as Handle, Rotate by r**, and then **Paste at Plane Origin** have the same result. #

2.2.9 Trim Away Unwanted Segments

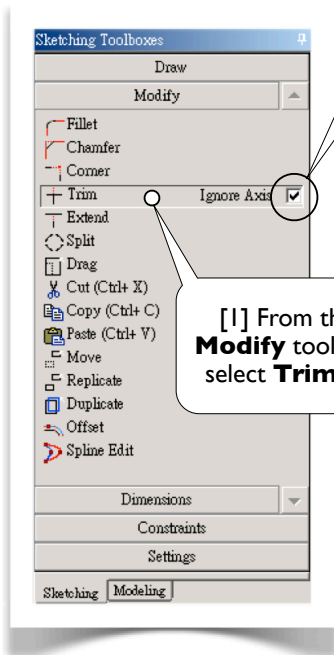

[2] Turn on **Ignore Axis** (2.1.8[2], page 65). ↓

[1] From the **Modify** toolbox, select **Trim**. ↑

[3] Click to trim away these 6 segments. #

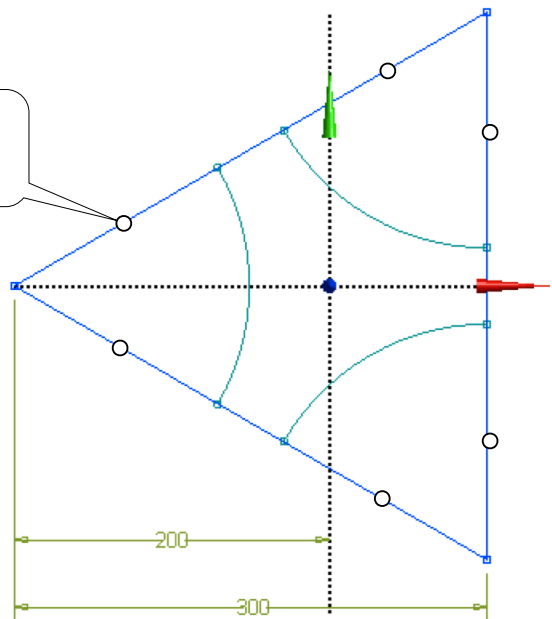

2.2.10 Impose Constraints

[1] From the **Constraints** toolbox, select **Equal Length**. ↑

[2] Select this segment and the vertical segment to make their lengths equal. ↓

[3] Select this segment and the vertical segment to make their lengths equal. ←

[4] Select **Symmetry**. →

[5] Select the horizontal axis as the line of symmetry. ↓

[6] And select the lower and upper arcs to make them symmetric. ↓

The sketch shows a vertical dashed line of symmetry. A horizontal dimension of 200 is shown on the left, and a vertical dimension of 300 is shown at the bottom. The sketch consists of three straight segments and three arcs.

Constraint Status

[7] The three straight segments turn blue, indicating they are well-defined, while the three arcs remain greenish-blue, indicating they are not well-defined yet (under-constrained). Other color codes are black for fixed, red for over-constrained, and gray for inconsistency. #

2.2.11 Specify Dimension for Side Edges

[1] Select the **Dimension** toolbox and leave **General** as the active tool. ↘

[2] Click the vertical segment and move the mouse rightward to create this dimension. All the entities turn to blue now. (The value 40 is typed in [3].) ↑

[3] Type 40 (mm) for the new dimension. #

The sketch shows a vertical dimension of 40 mm being applied to the right side of the sketch. The sketch is now entirely blue.

Details View	
Details of Sketch1	
Sketch	Sketch1
Sketch Visibility	Show Sketch
Show Constraints?	No
Dimensions: 3	
<input type="checkbox"/> H1	300 mm
<input type="checkbox"/> H2	200 mm
<input type="checkbox"/> V3	40 mm

2.2.12 Create Offset

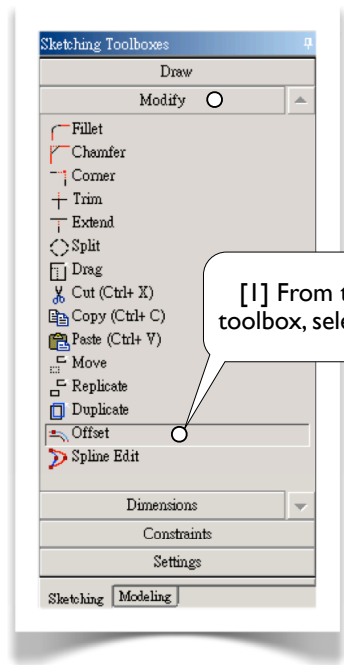

[1] From the **Modify** toolbox, select **Offset**.

[2] Sweep-select all the segments (sweep each segment while holding your left mouse button down, see 2.1.7[3], page 64). Sweep-select is also called *paint-select*. (See [3] for another way to select multiple entities.)

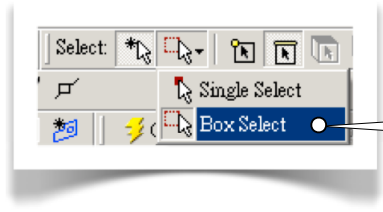
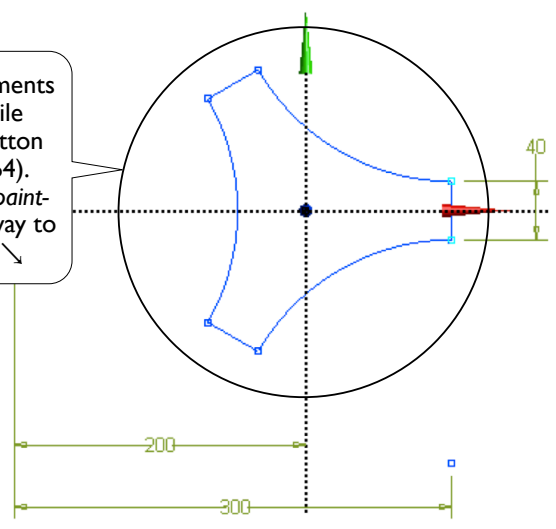

[3] Another way to select multiple entities is to switch **Select Mode** to **Box Select**, and then left-click-drag a box to select the entities inside the box.

[4] Right-click-select **End selection/Place Offset** from the context menu.

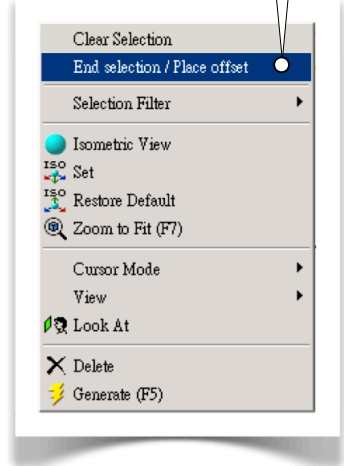

[5] Click roughly here to place the offset.

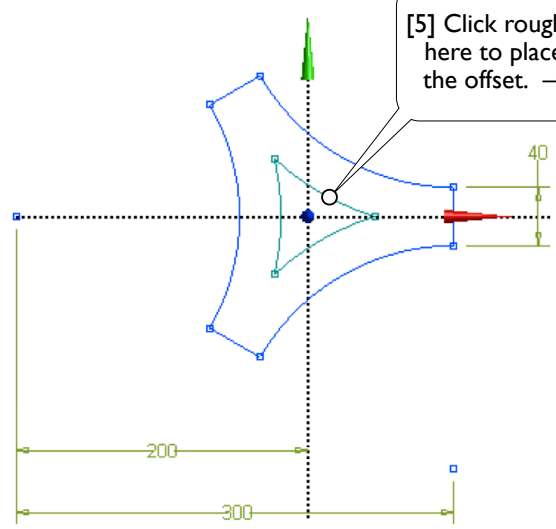

[6] Right-click-select **End** in the context menu, or press **ESC**, to close the **Offset** tool.

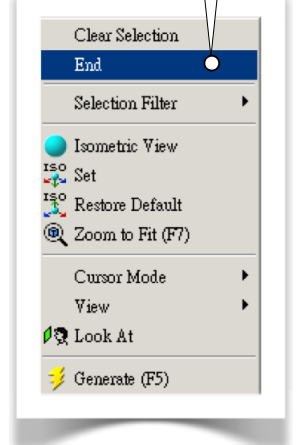

[7] From the **Dimension** toolbox, select **Horizontal**.

[8] Create this dimension by clicking the left two arcs and move downward. Note that all the entities turn to blue now.

[9] Type 30 (mm) for the new dimension.

[10] If you see something like this, never mind; there is nothing wrong with it. #

Details of Sketch1	
Sketch	Sketch1
Sketch Visibility	Show Sketch
Show Constraints?	No
Dimensions: 4	
<input type="checkbox"/> H1	300 mm
<input type="checkbox"/> H2	200 mm
<input type="checkbox"/> H4	30 mm
<input type="checkbox"/> V3	40 mm

2.2.13 Create Fillets

[1] In the **Modify** toolbox, select **Fillet**. Type 10 (mm) for **Radius**.

[2] Click these two segments to create a fillet. Repeat this step to create the other two fillets. The fillets are in greenish-blue color, indicating they are weakly defined (see [3]).

[3] Dimensions specified in a toolbox are "weak," meaning they may be overridden by other constraints or dimensions (also see 2.1.11 [5], page 67).

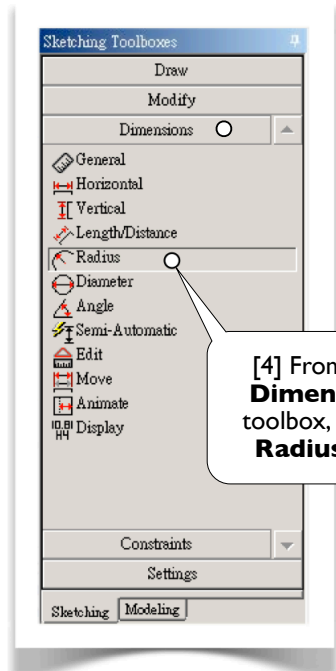

[5] Click one of the fillets to create this dimension. This turns a "weak" dimension to a "strong" one. Now, all the fillets are blue-colored. #

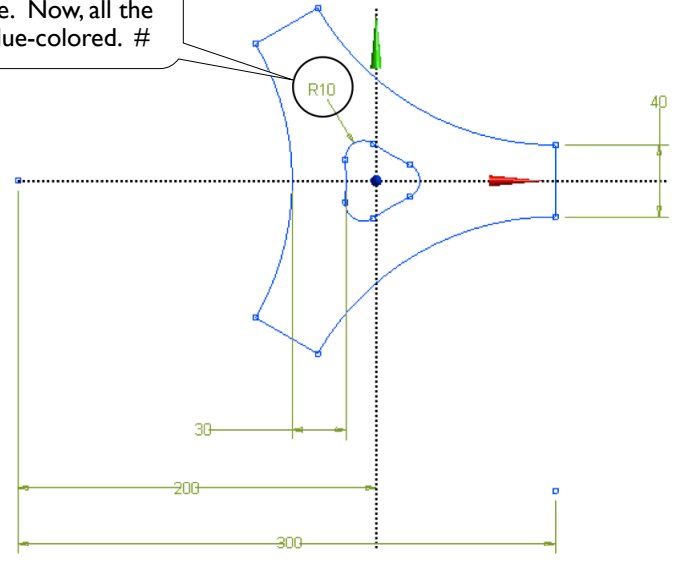

2.2.14 Extrude to Create 3D Solid

[1] Click the little cyan sphere for an isometric view. ↘

[2] Click **Extrude**. ↓

[3] Type 10 (mm) for **Depth**. Note that **Sketch1** is automatically entered as **Geometry**. ↑

[4] Click **Generate**. ↘

[5] Click **Zoom to Fit**. ↑

[6] Click **Display Plane** to turn off the display of the sketching plane. ↘

[7] Click all plus signs (+) to expand and browse the **model tree**. #

2.2.15 Save the Project and Exit Workbench

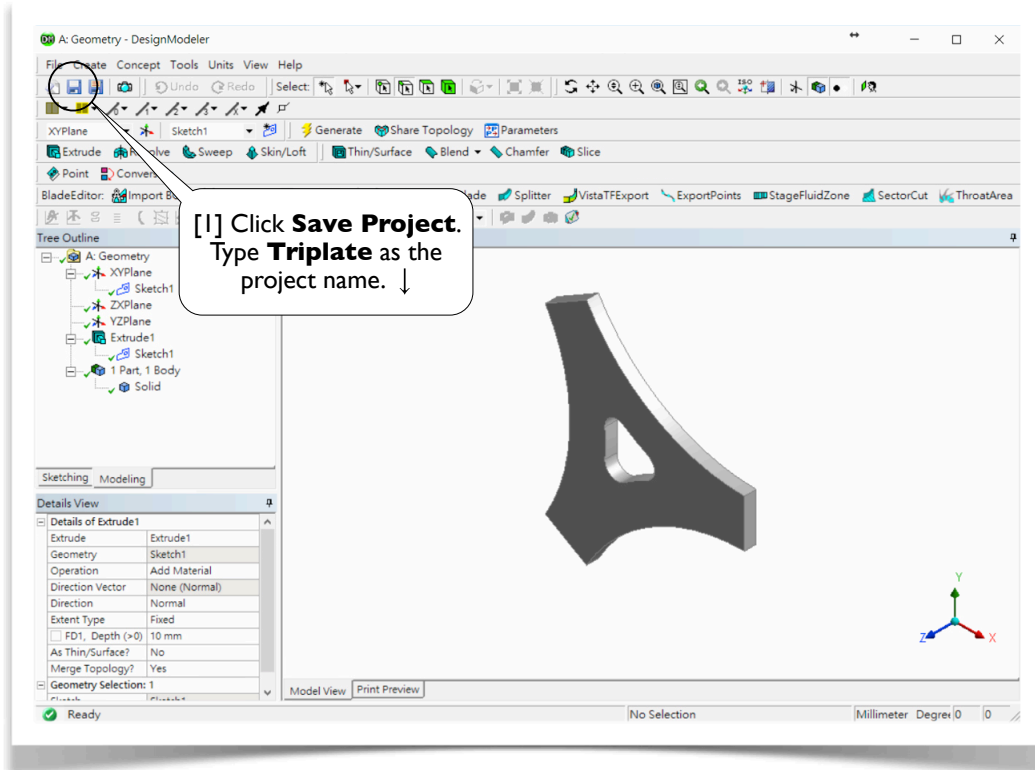

[2] In **Workbench GUI**, pull-down-select **File/Exit** to exit Workbench. We will resume this project in Section 3.1. #

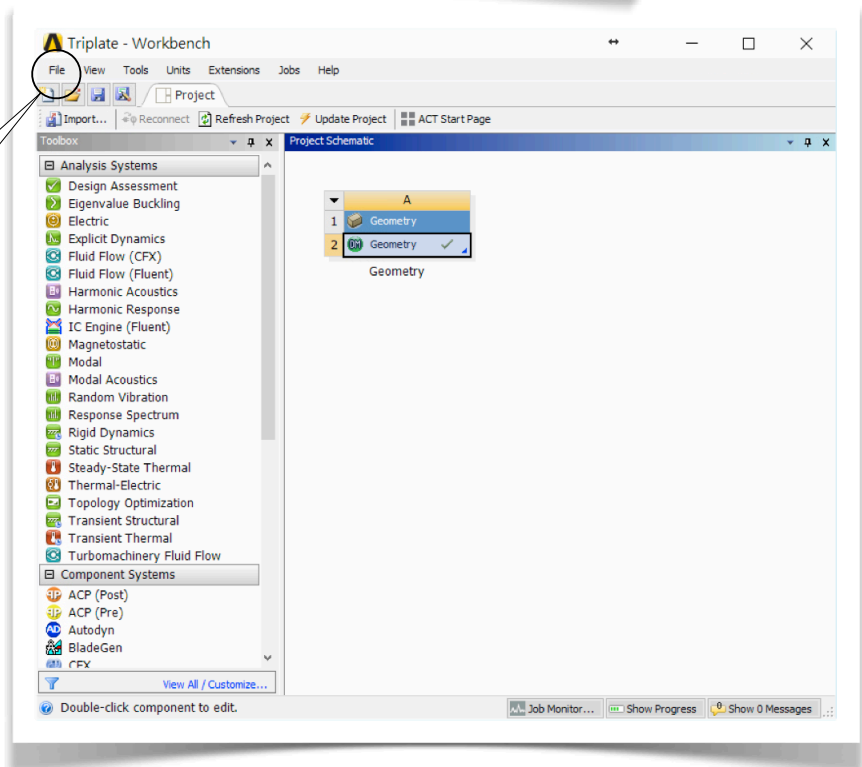

Section 2.3

More Details

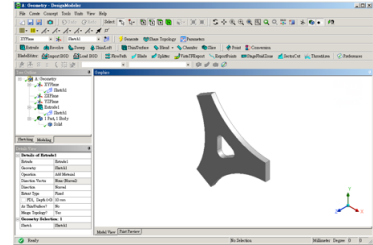

2.3.1 DesignModeler GUI

[1] **DesignModeler GUI** consists of several areas [2-8]. On the top are **pull-down menus** and **toolbars** [2]. On the bottom is a **status bar** [8]. In-between are several **window panes**. **Separators** [9] between window panes can be dragged to resize the window panes. You can make a window pane "float" by dragging or double-clicking its title bar. To return to its original position, simply double-click its title bar again.

Tree Outline [4] shares the same area with **Sketching Toolboxes** [5]. To switch between the **Modeling** mode and the **Sketching** mode, simply click a **mode tab** [3]. **Details View** [7] shows the detail information of the objects highlighted in **Tree Outline** [4] or **Graphics Window** [6]; the former displays a **Model Tree** (see [10], next page) while the latter displays a geometric model. Note that we discuss only the 2D functions of DesignModeler in this chapter and will discuss the 3D functions in Chapter 4. ↓

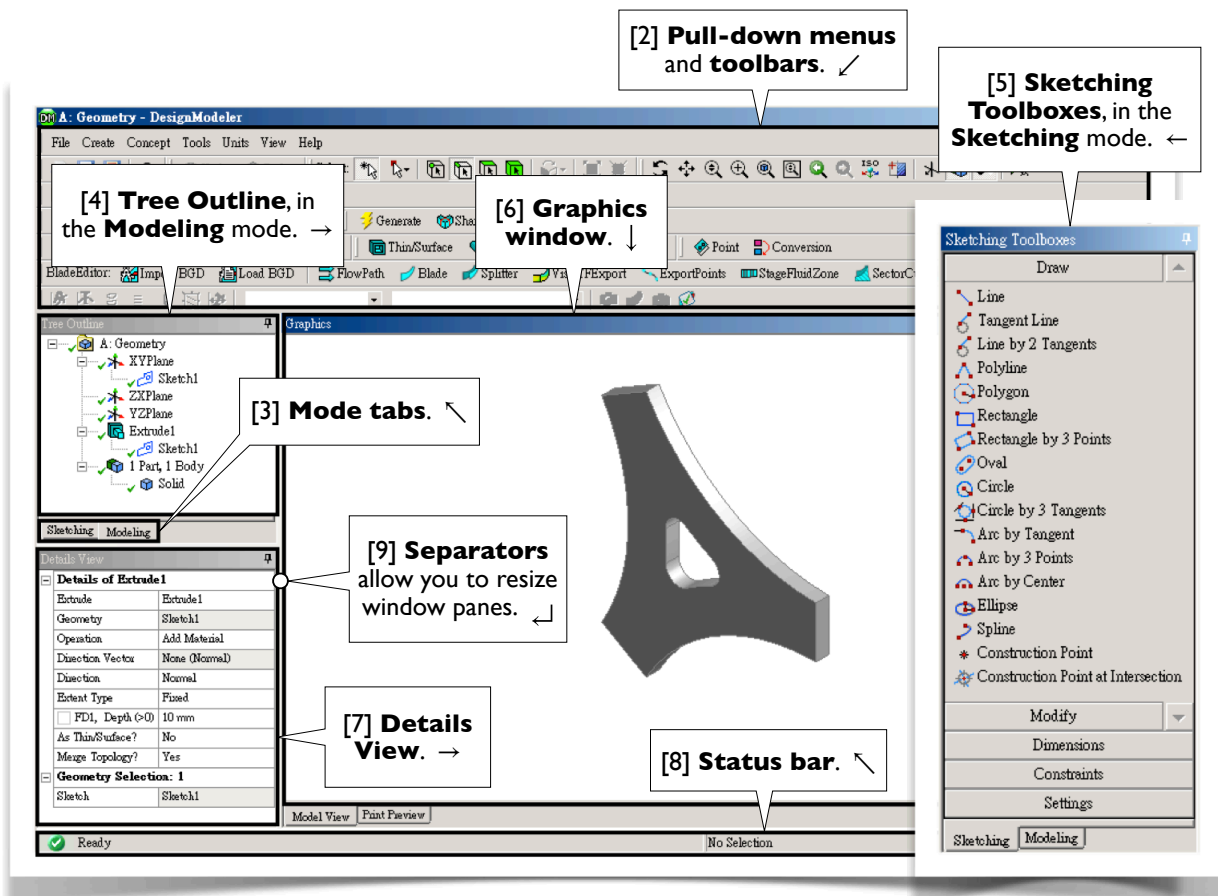

Model Tree

[10] **Tree Outline** [4] contains an outline of a **model tree**, the data structure of the geometric model. Each *branch* of the tree is called an *object*, which may contain one or more objects. At the bottom of the model tree is a **part** branch, which is the only object that will be exported to **Mechanical** for simulations. By right-clicking an object and selecting a tool from the *context menu*, you can operate on the object, such as delete, rename, duplicate, etc.

The order of the objects is relevant. DesignModeler renders the geometry according to the order of the objects in the model tree. New objects are normally added one after another. If you want to insert a new object **BEFORE** an existing object, right-click the existing object and select **Insert/...** from the context menu. After insertion, DesignModeler will re-render the geometry. #

2.3.2 Sketching Planes

[1] A sketch must be created on a *sketching plane*, or simply called a *plane*; each plane may contain multiple sketches. In the beginning of a DesignModeler session, three planes preexist: **XYPlane**, **YZPlane**, and **ZXPlane**. The currently active plane is shown on the toolbar [2]. You can create as many new planes as needed [3]. There are several ways to create a new plane [4]. In this chapter, since we always sketch on **XYPlane**, we will not discuss the creation of sketching planes now and will discuss it in Chapter 4. ✓

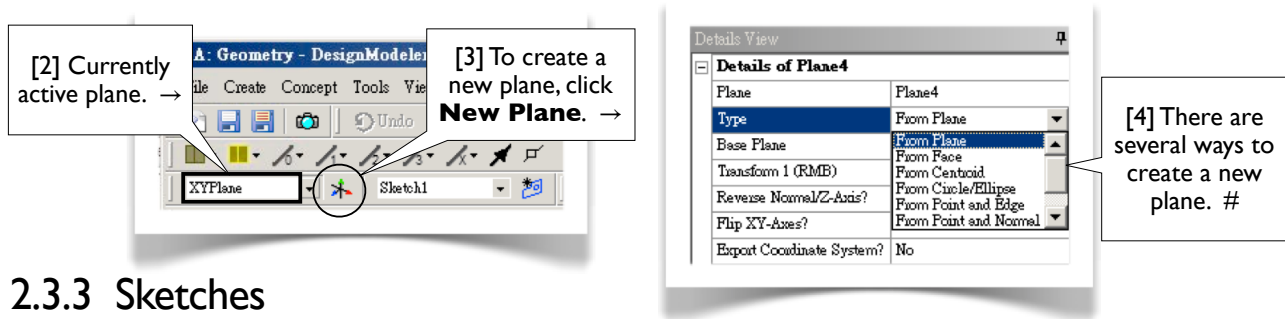

2.3.3 Sketches

[1] A sketch consists of *points* and *edges*; an edge may be straight or curved. Dimensions and constraints may be imposed on points and edges. As mentioned (2.3.2[1]), multiple sketches may be created on a plane. To create a new sketch on an empty plane, you simply switch to **Sketching** mode and draw any geometric entities on it. Later, if you want to add a new sketch on that plane, you have to click **New Sketch** [2]. Exactly one plane and one sketch is active at a time [3-6]; newly created points and edges are added to the active sketch, and newly created sketches are added to the active plane. In this chapter, we almost exclusively work with a single sketch; the only exception is Section 2.6, in which a second sketch is created (2.6.4[3], page 106). When a new sketch is created, it becomes the active sketch. More on creating sketches will be discussed in Chapter 4. ↘

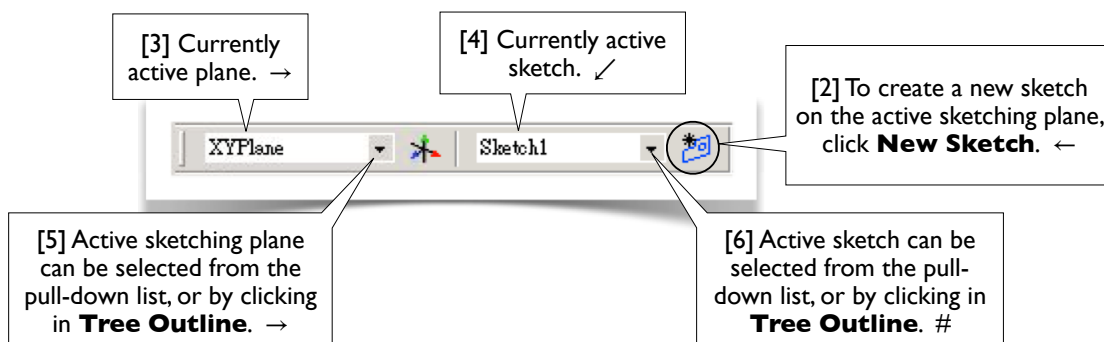

2.3.4 Sketching Toolboxes

[1] In the **Sketching** mode, five **Sketching Toolboxes** (2.3.1 [5], page 81) are available: **Draw**, **Modify**, **Dimensions**, **Constraints**, and **Settings** [2-6]. Most of the tools in the toolboxes are self-explained. The best way to learn these tools is to try them out individually. During the tryout, whenever you want to clean up the graphics window, pull-down-select **File/Start Over**. These sketching tools will be briefly discussed, starting from 2.3.6. Before we discuss these sketching tools, let's reiterate some useful tips about sketching as follows.

Pan, Zoom, and Box Zoom

Besides the **Pan** tool in 2.2.5[4], page 72, a sketch can also be panned by dragging your mouse while holding down both the control key and the middle mouse button (2.1.7[7], page 64). Besides the **Zoom** tool in 2.2.5[6], page 72, a sketch can also be zoomed in/out by simply rolling your mouse wheel (2.1.7[6], page 64); the cursor position is the "zoom center." Besides the **Box Zoom** tool in 2.2.5[5], page 72, box zoom can also be done by dragging a rectangle in the graphics window using the right mouse button (2.1.7[5], page 64). After you are familiar with these mouse shortcuts, you usually don't need the **Pan**, **Zoom**, and **Box Zoom** tools in 2.2.5[4-6], page 72.

Context Menu

While most of the operations can be done by commands in pull-down menus or toolbars, many operations either require or are more efficient using a context menu. The context menu can be popped-up by right-clicking an entity in the graphics window or an object in the model tree. Try to explore whatever is available in the context menu.

Status Bar

The status bar (2.3.1 [8], page 81) contains instructions on each operation. Look at the instructions whenever helpful. When a draw tool is in use, the coordinates of your mouse pointer are shown in the status bar. ✓

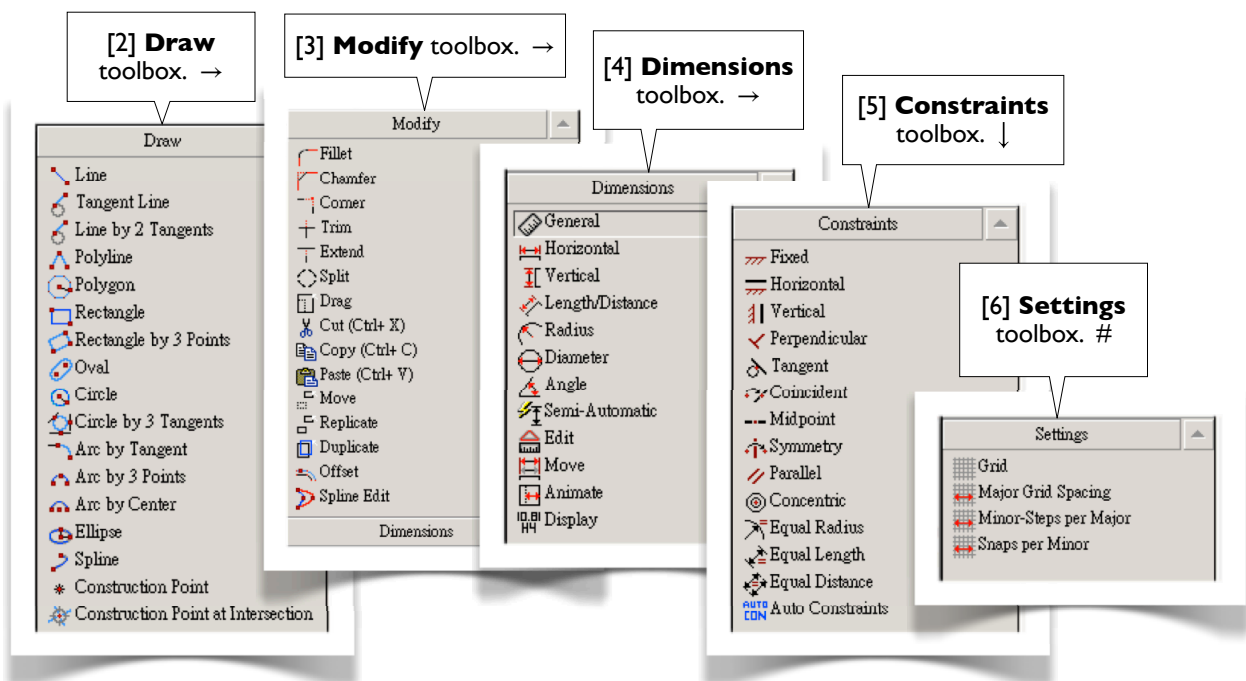

2.3.5 Auto Constraints^[Refs 1,2]

[1] By default, DesignModeler is in the **Auto Constraints** mode, both globally and locally. DesignModeler attempts to detect the user's intentions and tries to automatically impose constraints on sketching entities. The following cursor symbols indicate the kind of constraints that are applied:

- C - The cursor is coincident with a line.
- P - The cursor is coincident with a point.
- T - The cursor is a tangent point.
- ⊥ - The cursor is a perpendicular foot.
- H - The line is horizontal.
- V - The line is vertical.
- // - The line is parallel to another line.
- R - The radius is equal to another radius.

Both **Global** and **Cursor** modes are based on all entities of the active plane (not just the active sketch). The difference is that **Cursor** mode only examines the entities nearby the cursor, while **Global** mode examines all the entities in the active plane. →

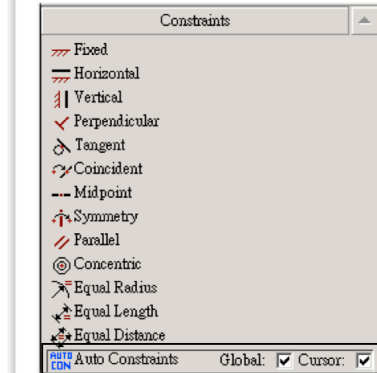

[2] By default, DesignModeler is in the **Auto Constraints** mode, both globally and locally. #

2.3.6 Draw Tools^[Ref 3]

Line

[2] Draws a line by two clicks.

Tangent Line

Click a point on a curve (e.g., circle, arc, ellipse, or spline) to create a line tangent to the curve at that point.

Line by 2 Tangents

Click two curves to create a line tangent to these two curves. Click a curve and a point to create a line tangent to the curve and connecting to the point.

Polyline

A polyline consists of multiple straight lines. A polyline must be completed by choosing either **Open End** or **Closed End** from the context menu ([3], next page).

Polygon

Draws a regular polygon. The first click defines the center and the second click defines the radius of the circumscribing circle. ↵

[1] The **Draw** toolbox. ←

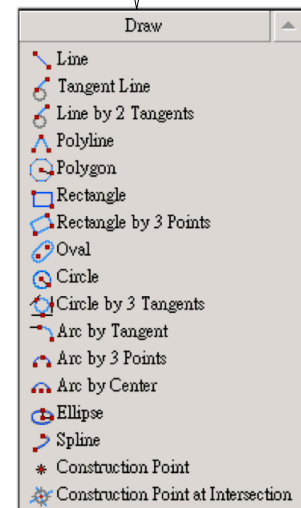

Rectangle by 3 Points

[4] The first two points define one side and the third point defines the other side.

Oval

The first two clicks define two centers, and the third click defines the radius.

Circle

The first click defines the center, and the second click defines the radius.

Circle by 3 Tangents

Select three edges (lines or curves) to create a circle tangent to these three edges.

Arc by Tangent

Click a point (usually an end point) on an edge to create an arc starting from that point and tangent to that edge; click a second point to define the other end and the radius of the arc.

Arc by 3 Points

The first two clicks define the two ends of the arc, and the third click defines a point between the ends.

Arc by Center

The first click defines the center, and two additional clicks define two ends.

Ellipse

The first click defines the center, the second click defines the major radius, and the third click defines the minor radius.

Spline

A spline is either rigid or flexible. A flexible spline can be edited or changed by imposing constraints, while a rigid spline cannot. After defining the last point, you must specify an ending condition [5]: either open end or closed end; either with fit points or without fit points.

Construction Point at Intersection

Select two edges; a construction point will be created at the intersection. ↗

[3] A polyline must be completed by choosing either **Open End** or **Closed End** from the context menu. ←

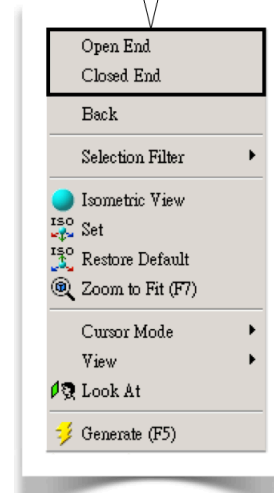

> Open End
 > Open End with Fit Points
 > Open End with Control Points
 > Open End with Fit and Control Points
 > Closed End
 > Closed End with Fit Points

[5] A spline must be complete by specifying an ending condition from the context menu. ↓

How to delete edges?

[6] To delete edges, select them and choose **Delete** or **Cut** from the context menu. Multiple selection methods (e.g., control-selection or sweep-selection) can be used to select the edges. To clean up the graphics window entirely, pull-down-select **File/Start Over**. A general way of deleting any sketching entities (edges, dimensions, or constraints) is to right-click the entity in **Details View** and issue **Delete**. Also see 2.3.8[8-10], page 89, and 2.3.9[5-7], page 90.

How to abort a tool?

Simply press **ESC**. #

2.3.7 Modify Tools^[Ref 4]

Fillet

[2] Select two edges or a vertex to create a fillet. The radius of the fillet can be specified in the toolbox [3]. Note that this radius value is a weak dimension; i.e., it can be changed by other dimensions or constraints.

Chamfer

Select two edges or a vertex to create an equal-length chamfer. The sizes of the chamfer can be specified in the toolbox.

Corner

Select two edges, and the edges will be trimmed or extended up to the intersection point and form a sharp corner. The clicking points decide which sides to be trimmed.

Trim

Select an edge, and the portion of the edge will be removed up to its intersection with another edge, axis, or point.

Extend

Select an edge, and the edge will be extended up to an edge or axis.

Split

This tool splits an edge into several segments depending on the options from the context menu [4]. **Split Edge at Selection:** Click an edge, and the edge will be split at the clicking point. **Split Edges at Point:** Click a point, and all the edges passing through that point will be split at that point. **Split Edge at All Points:** Click an edge, and the edge will be split at all points on the edge. **Split Edge into n Equal Segments:** Click an edge and specify a value n , and the edge will be split equally into n segments.

Drag

Drags a point or an edge to a new position. All the constraints and dimensions are preserved.

Copy

Copies the selected entities to a "clipboard." A **Paste Handle** must be specified using one of the methods in the context menu [5]. After completing this tool, **Paste** tool is automatically activated. ↗

[1] The **Modify** toolbox. ←

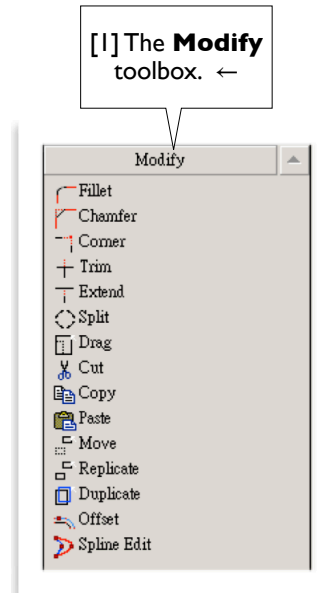

[3] The radius of fillets can be suggested; it is a "weak" dimension. ↓

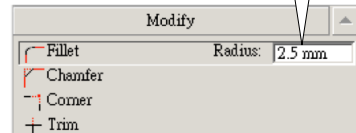

[4] Options of **Split** in the context menu. ↓

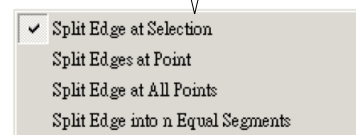

[5] Options of **Copy** in the context menu. ↵

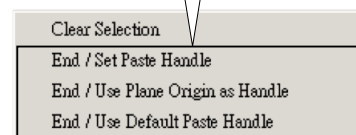

Cut

[6] Similar to **Copy**, except that the copied entities are removed.

Paste

Pastes the entities in the "clipboard" to the graphics window. The click defines the point at which the **Paste Handle** positions. Many options can be chosen from the context menu [7], where the rotating angle **r** and the scaling factor **f** can be specified in the toolbox.

Move

Equivalent to a **Cut** followed by a **Paste**. (The original is removed.)

Replicate

Equivalent to a **Copy** followed by a **Paste**. (The original is preserved.)

Duplicate

Similar to **Replicate**. However, **Duplicate** copies entities to the same position in the active plane. **Duplicate** can be used to copy features of a solid body or plane boundaries.

Offset

Creates a set of edges that are offset by a distance from an existing set of edges.

Spline Edit

Used to modify flexible splines. You can insert, delete, drag the fit points, etc [8]. For details, see the reference^[Ref 4]. ↗

[7] Options of **Paste** in the context menu. ↓

Rotate by r Degrees
 Rotate by -r Degrees
 Flip Horizontal
 Flip Vertical
 Scale by factor f
 Scale by factor 1/f
 Paste at Plane Origin
 Change Paste Handle

[8] Options of **Spline Edit** in the context menu. #

Select New Spline
 Re-fit Spline
 Create Missing Fit Points
 Delete New Fit Points
 Create Missing Control Points
 Drag Fit Point
 Drag Control Point
 Insert Fit Point
 Delete Fit Point

[1] The **Dimension** toolbox. ✓

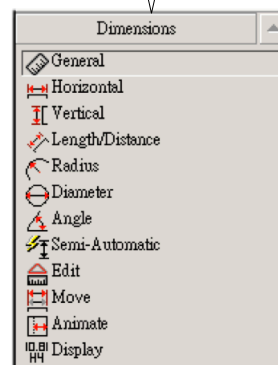

2.3.8 Dimensions Tools^[Ref 5] [1]

General

[2] Allows creation of any of the dimension types, depending on what edge and context-menu options are selected. If the selected edge is a straight line, the default dimension is its length ([3], next page.) If the selected edge is a circle or arc, the default dimension is its radius ([4], next page). ↵

Horizontal

[5] Select two points to specify a horizontal. If you select an edge (instead of a point), the end point near the click will be picked.

Vertical

Similar to **Horizontal**.

Length/Distance

Select two points to specify a distance dimension. You also can select a point and a line to specify the distance between the point and the line.

Radius

Select a circle or arc to specify a radius dimension. If you select an ellipse, the major (or minor) radius will be specified.

Diameter

Select a circle or arc to specify a diameter dimension.

Angle

Select two lines to specify an angle. By varying the selection order and location, you can control which angle you are dimensioning. The end of the lines that you select will be the arrow point of the hands, and the angle is measured counterclockwise from the first hand to the second. If the angle is not what you want, repeatedly choose **Alternate Angle** from the context menu until a correct angle is selected [6].

Semi-Automatic

This tool displays a series of dimensions automatically to help you fully dimension the sketch.

Edit

Click a dimension and this tool allows you to change its name or values.

Move

Click a dimension and move it to a new position.

Animate

Click a dimension to show the animated effects.

Display

Allows you to decide whether to display dimension names, values, or both. In this book, we always choose to display dimension values [7] rather than dimension names. ↗

[3] Options of **General** in the context menu if you select a line. ↓



[4] Options of **General** in the context menu if you select a circle or arc. ←

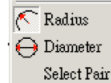

[6] You may repeatedly choose **Alternate Angle** from the context menu until the correct angle is selected. ↓

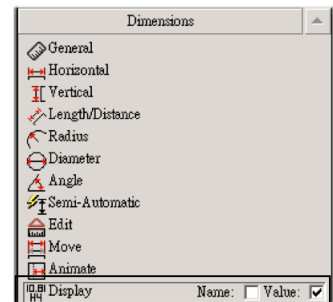
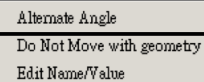

[7] In this book, we always display dimension values. ←

How to delete dimensions?

[8] To delete a dimension, select the dimension in **Details View**, and choose **Delete** from the context menu [9]. You can delete ALL the dimensions by right-clicking **Dimensions** in **Details View** [10]. →

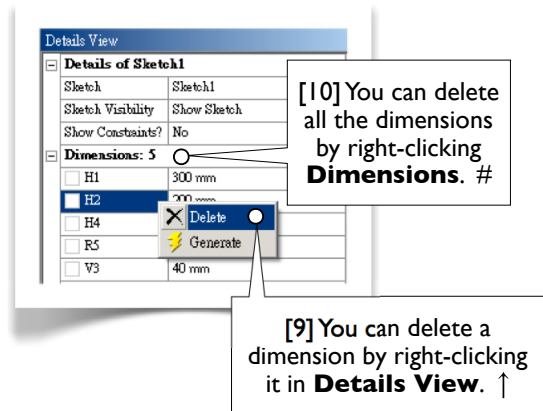

2.3.9 Constraints Tools^[Ref 6]

Fixed

[2] Applies on an edge to make it fully constrained if **Fix Endpoints** is selected [3]. If **Fix Endpoints** is not selected, then the edge's endpoints can be changed, but not the edge's position and slope.

Horizontal

Applies to a line to make it horizontal.

Vertical

Applies to a line to make it vertical.

Perpendicular

Applies to two edges to make them perpendicular to each other.

Tangent

Applies to two edges, one of which must be a curve, to make them tangent to each other.

Coincident

Select two points to make them coincident. Or, select a point and an edge to make the edge or its extension pass through the point. There are other possibilities, depending on how you select the entities.

Midpoint

Select a line and a point to make the midpoint of the line coincide with the point.

Symmetry

Select a line or an axis, as the line of symmetry, and then select two entities to make them symmetric about the line of symmetry. →

[1] The **Constraints** toolbox. ←

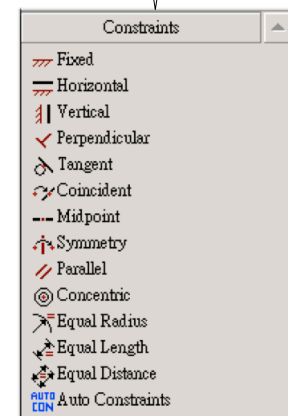

[3] If **Fix Endpoints** is selected, the edge will be fully constrained. ↵

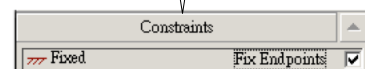

Parallel

[4] Applies to two lines to make them parallel to each other.

Concentric

Applies to two curves, which may be circle, arc, or ellipse, to make their centers coincident.

Equal Radius

Applies to two curves, which must be circle or arc, to make their radii equal.

Equal Length

Applies to two lines to make their lengths equal.

Equal Distance

Applies to two distances to make them equal. A distance can be defined by selecting two points, two parallel lines, or one point and one line.

Auto Constraints

Allows you to turn on/off **Auto Constraints** (2.3.5, page 84). ↓

How to delete constraints?

[5] By default, constraints are not displayed in **Details View**. To display constraints, select **Yes** for **Show Constraints?** in **Details View** [6]. To delete a constraint, right-click the constraint and issue **Delete** [7]. ↓

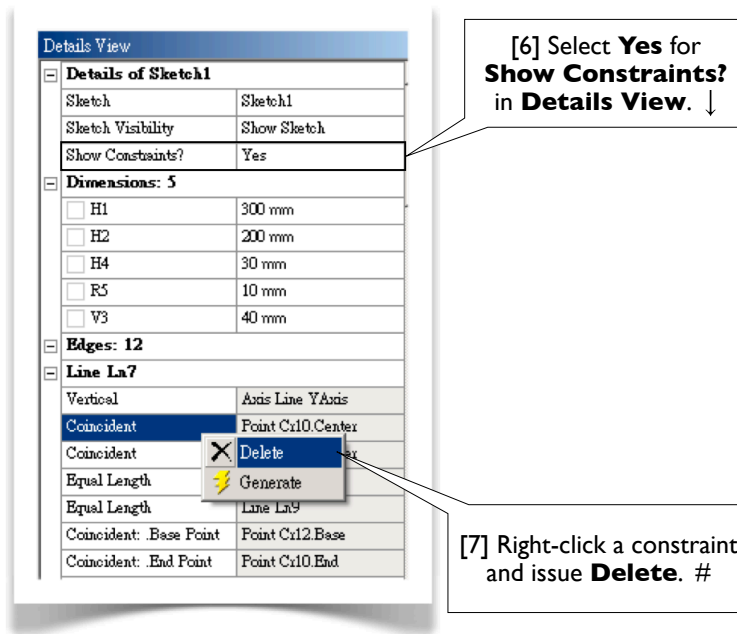

2.3.10 Settings Tools^[Ref 7]

Grid

[2] Allows you to turn on/off grid visibility and snap capability [3-4]. The grid is not required to enable snapping.

Major Grid Spacing

Allows you to specify **Major Grid Spacing** [5-6] if **Show in 2D** is turned on.

Minor-Steps per Major

Allows you to specify **Minor-Steps per Major** [7-8] if **Show in 2D** is turned on.

Snaps per Minor

Allows you to specify **Snaps per Minor** [9] if **Snap** is turned on. ↗

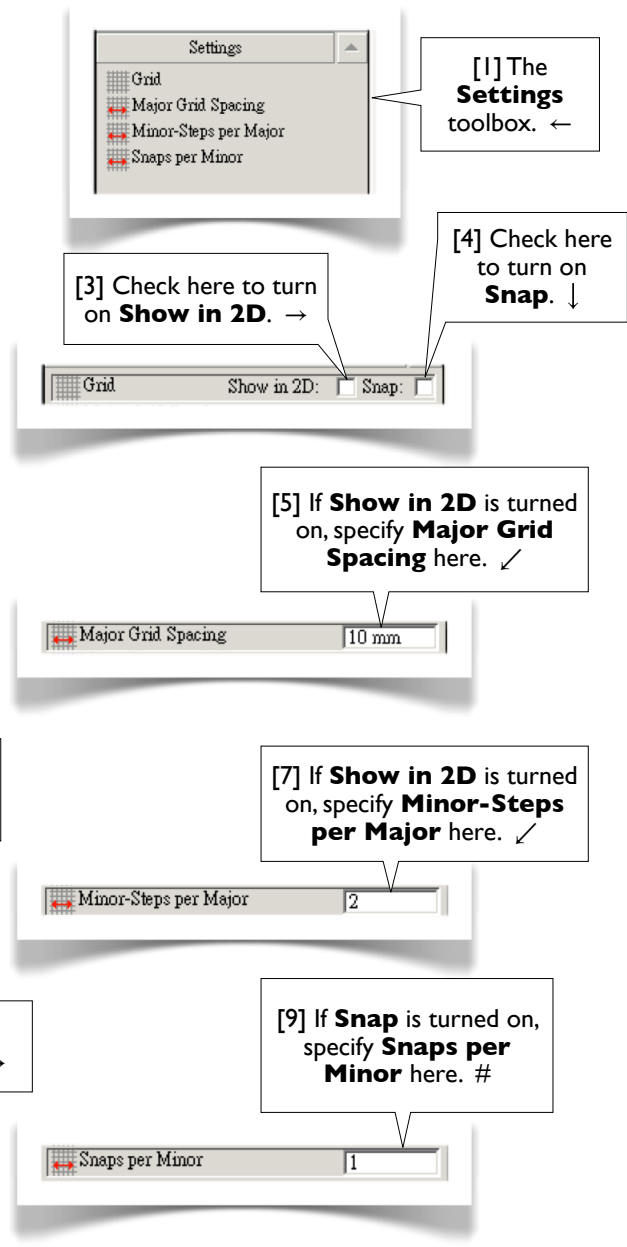

References

1. All Help>DesignModeler>ANSYS DesignModeler User's Guide>2D Sketching>Auto Constraints
2. All Help>DesignModeler>ANSYS DesignModeler User's Guide>2D Sketching>Constraints Toolbox//Auto Constraints
3. All Help>DesignModeler>ANSYS DesignModeler User's Guide>2D Sketching>Draw Toolbox
4. All Help>DesignModeler>ANSYS DesignModeler User's Guide>2D Sketching>Modify Toolbox
5. All Help>DesignModeler>ANSYS DesignModeler User's Guide>2D Sketching>Dimensions Toolbox
6. All Help>DesignModeler>ANSYS DesignModeler User's Guide>2D Sketching>Constraints Toolbox
7. All Help>DesignModeler>ANSYS DesignModeler User's Guide>2D Sketching>Settings Toolbox

Section 2.4

M20x2.5 Threaded Bolt

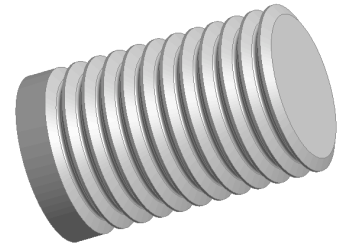

2.4.1 About the M20x2.5 Threaded Bolt^[Refs 1,2]

[1] In this section, we'll create a sketch and revolve the sketch 360° to generate a 3D solid body, a body representing a portion of an M20x2.5 threaded bolt as shown in [2-7]. We will use this sketch in Section 3.2 again to generate a 2D solid body, which is then used for a static structural simulation. ↓

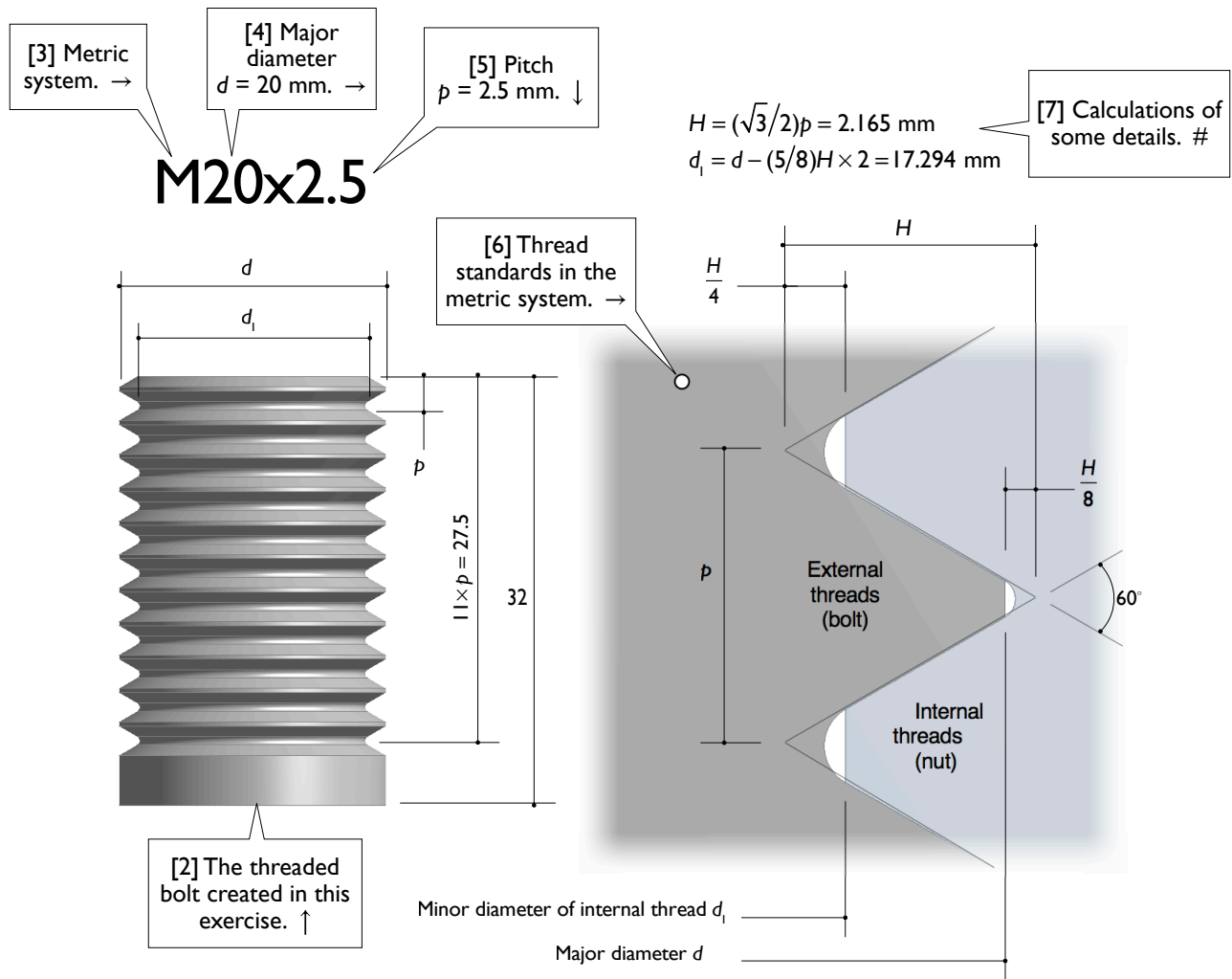

2.4.2 Draw a Horizontal Line

[1] Launch Workbench and create a **Geometry** system. Save the project as **Threads**. Start up DesignModeler. Select **Millimeter** as the length unit and make sure that **Degree** is the angle unit.

On **XYPlane**, draw a horizontal line and specify the dimensions (8.647 mm and 27.5 mm) as shown in [2]. →

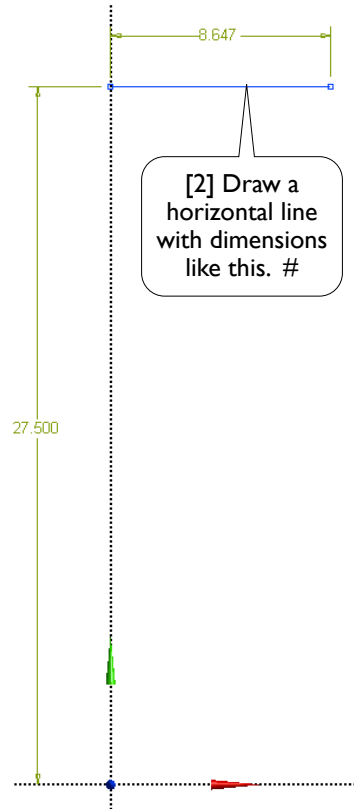

2.4.3 Draw a Polyline

[1] Draw a polyline of 3 segments [2-3] and specify the dimensions (30°, 60°, 60°, 0.541 mm, and 2.165 mm) as shown. To specify angle dimensions, please see **Angle**, 2.3.8[5], page 88. ↓

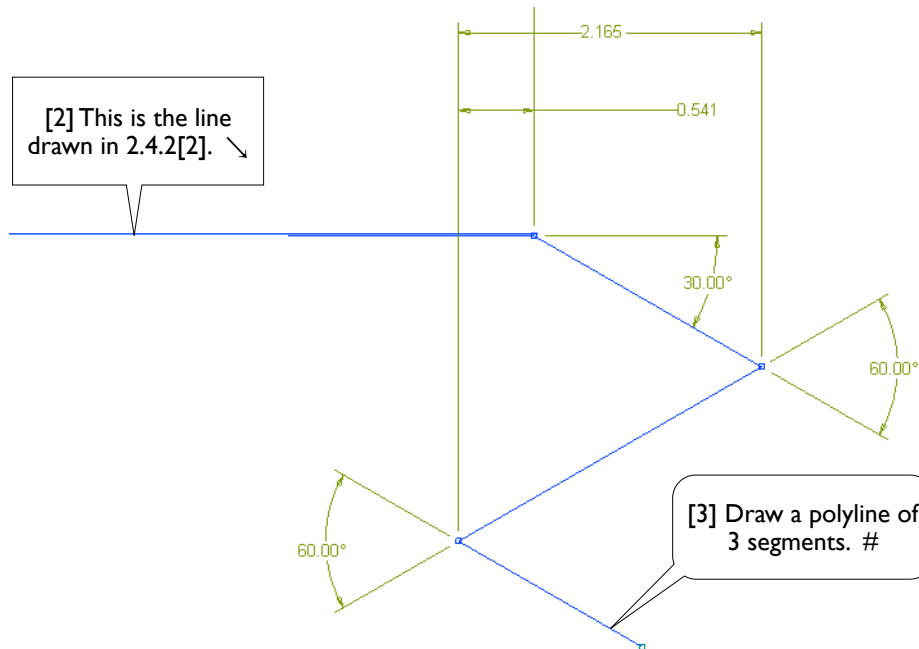

2.4.4 Draw a Line and a Fillet

[1] Draw a vertical line and specify its position [2].
 Create a fillet and specify its position [3-4]. ↘

[2] Draw a vertical line and specify its position (0.271 mm). ←

[3] Create a fillet (also see [4]) and specify its position (0.541 mm). →

[4] Before creating fillets, specify an approximate radius value, say 0.5 mm. #

2.4.5 Trim Away Unwanted Segments

[1] Trim away these three segments. →

[2] The sketch after trimming. #

2.4.6 Replicate 10 Times

[1] Select the **Replicate** tool and select all segments except the horizontal line (4 segments in total), and replicate 10 times. Set the **Paste Handle** as shown in [2]. You may need to use **Selection Filter: Points** [3] (also see 2.2.8[7-8], page 74). ↓

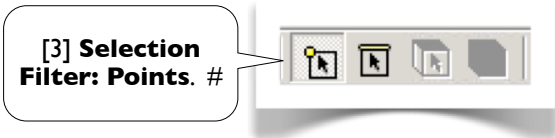

[2] Set **Paste Handle** at this point (also see [3]). ←

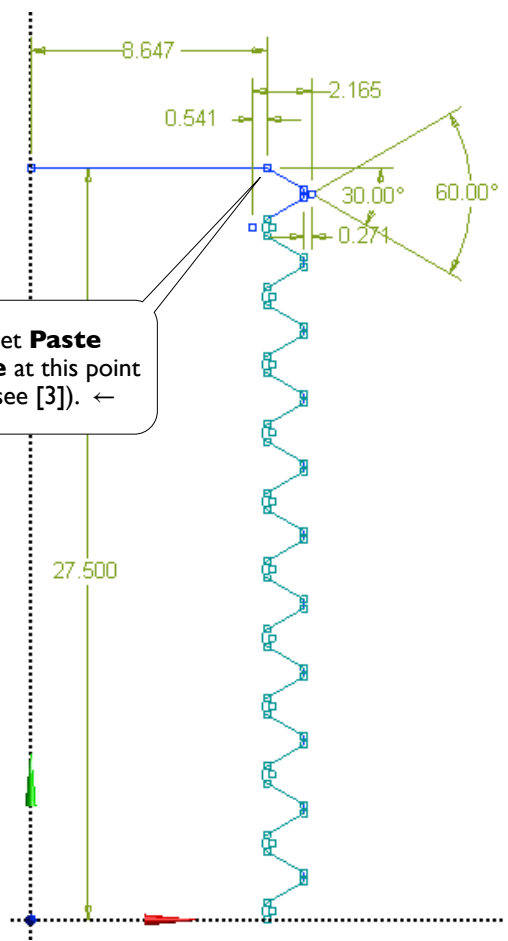

2.4.7 Complete the Sketch

[2] Draw this vertical line, which passes through the origin. ↓

[5] Draw this horizontal line. #

[3] Specify this dimension (4.5 mm). →

[1] Create this segment, using **Replicate**. ←

[4] Draw this vertical line. You may need to trim away extra length later after the next step. ←

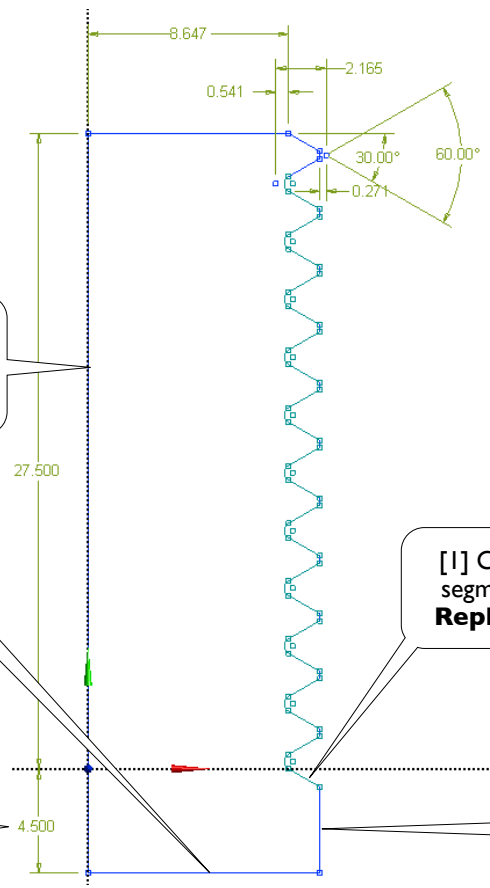

2.4.8 Revolve to Create 3D Solid

[1] Click **Revolve** to generate a solid of revolution. Select the Y-axis as the axis of revolution [2]. Remember to click **Generate**. Save the project and exit Workbench. We will resume this project in Section 3.2. ↓

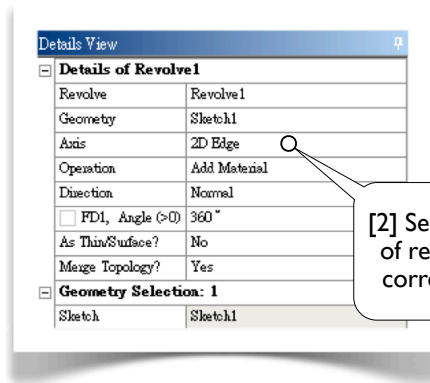
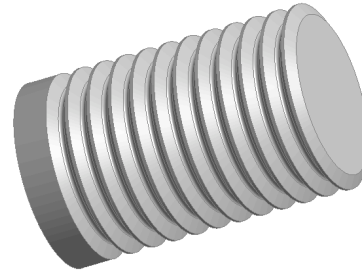

[2] Select the Y-axis as the **Axis** of revolution. (Make sure you correctly select the Y-axis.) #

References

1. Zahavi, E., *The Finite Element Method in Machine Design*, Prentice-Hall, 1992; Chapter 7. Threaded Fasteners.
2. Deutschman, A. D., Michels, W. J., and Wilson, C. E., *Machine Design: Theory and Practice*, Macmillan Publishing Co., Inc., 1975; Section 16-6. Standard Screw Threads.

Section 2.5

Spur Gears

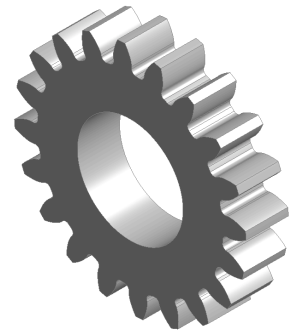

2.5.1 and 2.5.2 give the geometry of the spur gear used in this section. If you are not interested in these geometric details for now, you may skip them and jump directly to 2.5.3 (page 99).

2.5.1 About the Spur Gears^[Refs 1, 2]

[1] The figure below shows a pair of identical spur gears in mesh [2-5]. Spur gears have their teeth cut parallel to the axis of the shaft on which the gears are mounted, transmitting power between the parallel shafts. To maintain a constant angular velocity ratio, two meshing gears must satisfy a fundamental law of gearing: the shape of the teeth must be such that the common normal [9] at the point of contact between two teeth must always pass through a fixed point on the line of centers^[Ref 1] [6]. The contact point is called the *pitch point* [7].

The angle between the line of action [9] and the common tangent of the pitch circles [8] is known as the *pressure angle*. The spur gear is defined by its pitch radius ($r_p = 2.5$ in) [4], pressure angle ($\alpha = 20^\circ$) [9], and number of teeth ($N = 20$). The teeth are cut with a radius of addendum $r_a = 2.75$ in [10] and a radius of dedendum $r_d = 2.2$ in [11]. The shaft has a radius of 1.25 in [12]. All fillets have a radius of 0.1 in [13]. The thickness of the gear is 1.0 in. ✓

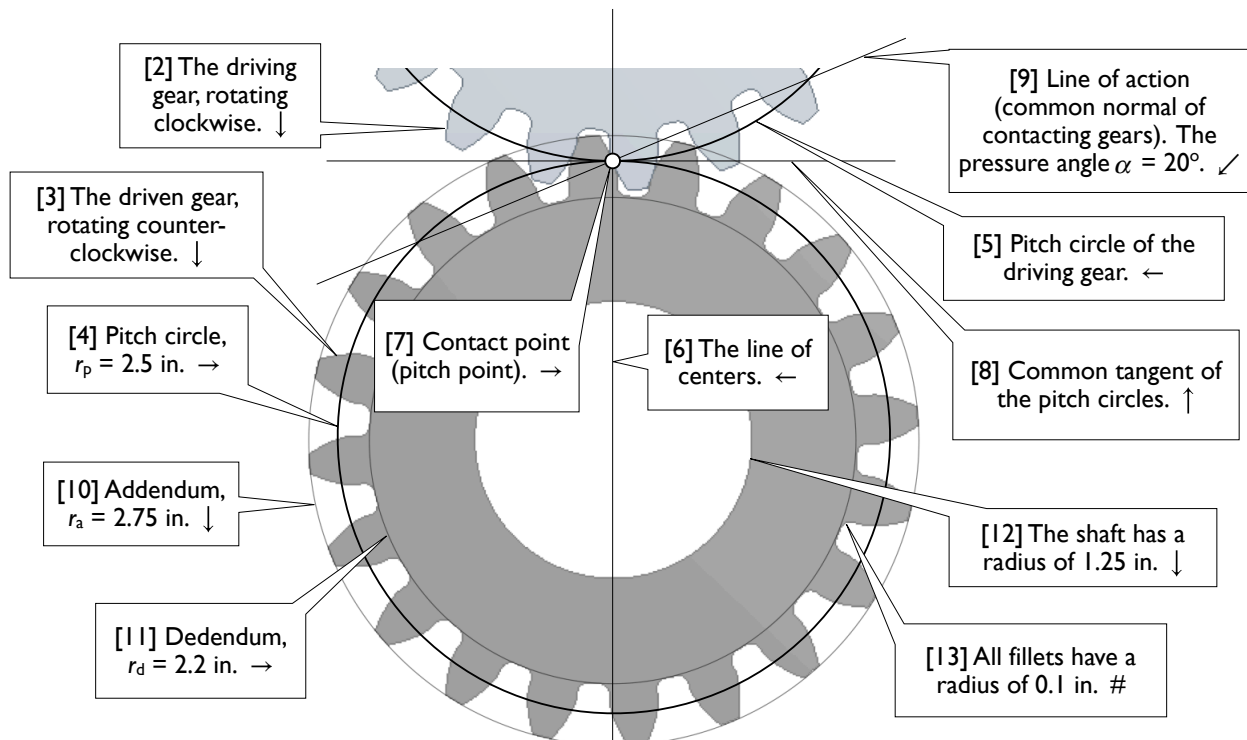

2.5.2 About Involute Curves^[Refs 1, 2]

[1] To satisfy the fundamental law of gearing, gear profiles are usually cut to an *involute curve* [2], which may be constructed by wrapping a string (*BA*) around a *base circle* [3], and then tracing the path (*A-P-F*) of a point (*A*) on the string. Given the gear's pitch radius r_p and pressure angle α , we can calculate the coordinates of each point on the involute curve. ↘

[4] For example, let's calculate the polar coordinates (r, θ) of an arbitrary point *A* [5] on the involute curve. Note that *BA* and *CP* are tangent lines of the base circle, and *F* is a foot of perpendicular.

Since *APF* is an involute curve and *BCDEF* is the base circle, by the definition of involute curve,

$$\overline{BA} = \overline{BCDEF} \quad (1)$$

$$\overline{CP} = \overline{CDEF} \quad (2)$$

In $\triangle OCP$,

$$r_b = r_p \cos \alpha \quad (3)$$

In $\triangle OBA$,

$$r = \frac{r_b}{\cos \phi} \quad (4)$$

Or,

$$\phi = \cos^{-1} \frac{r_b}{r} \quad (5) \nearrow$$

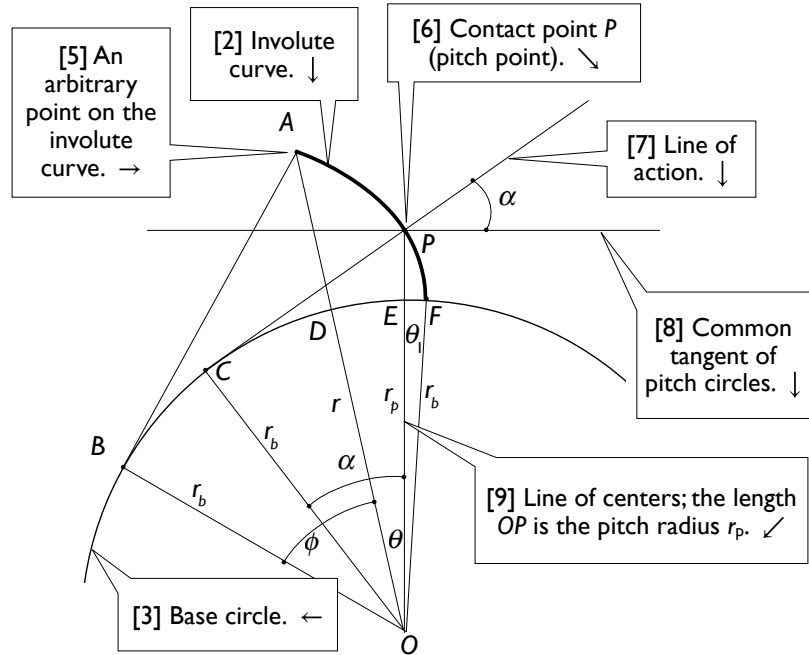

[10] To calculate θ , we notice that

$$\widehat{DE} = \widehat{BCDEF} - \widehat{BCD} - \widehat{EF}$$

Dividing the equation with r_b and using Eq. (1),

$$\frac{\widehat{DE}}{r_b} = \frac{\overline{BA}}{r_b} - \frac{\widehat{BCD}}{r_b} - \frac{\widehat{EF}}{r_b}$$

If radian is used, then the above equation can be written as

$$\theta = (\tan \phi) - \phi - \theta_1 \quad (6)$$

The last term θ_1 is the angle $\angle EOF$, which can be calculated by dividing Eq. (2) with r_b ,

$$\frac{\overline{CP}}{r_b} = \frac{\widehat{CDEF}}{r_b}, \text{ or } \tan \alpha = \alpha + \theta_1, \text{ or}$$

$$\theta_1 = (\tan \alpha) - \alpha \quad (7)$$

We'll show how to calculate polar coordinates (r, θ) using Eqs. (3-7). The polar coordinates then can be easily transformed to rectangular coordinates, using *O* as origin and *OP* as *y*-axis,

$$x = -r \sin \theta, \quad y = r \cos \theta \quad (8) \swarrow$$

Numerical Calculations of Coordinates

[1] In our case, the pitch radius $r_p = 2.5$ in, and pressure angle $\alpha = 20^\circ$; from Eqs. (3) and (7) respectively,

$$r_b = 2.5 \cos 20^\circ = 2.349232 \text{ in}$$

$$\theta_1 = \tan 20^\circ - \frac{20^\circ}{180^\circ} \pi = 0.01490438 \text{ (rad)}$$

The table below lists the calculated coordinates. The values in the first column (r) are chosen such that, except the pitch point ($r = 2.5$ in), the intermediate points are at the quarter points between r_b ($r = 2.349232$ in) and r_o ($r = 2.75$ in). Also note that, when using Eqs. (6) and (7), radians are used as the unit of angles; in the table below, however, degrees are used. #

r in.	ϕ Eq. (5), degrees	θ Eq. (6), degrees	$x = -r \sin \theta$ in.	$y = r \cos \theta$ in.
2.349232	0.000000	-0.853958	-0.03501	2.3490
2.449424	16.444249	-0.387049	-0.01655	2.4494
2.500000	20.000000	0.000000	0.00000	2.5000
2.549616	22.867481	0.442933	0.01971	2.5495
2.649808	27.555054	1.487291	0.06878	2.6489
2.750000	31.321258	2.690287	0.12908	2.7470

2.5.3 Draw an Involute Curve

[1] Launch Workbench. Create a **Geometry** system. Save the project as **Gear**. Start up DesignModeler. Select **Inch** as the length unit.

From the **Draw** toolbox, select the **Construction Point** tool, draw 6 points on **XYPlane** and specify dimensions as shown, where the vertical dimensions are measured from the X-axis and the horizontal dimensions are measured from the Y-axis. The pitch point [2] is coincident with the Y-axis.

Connect these six points using the **Spline** tool in the **Draw** toolbox, leaving **Flexible** option on, finishing the spline with **Open End**. →

[3] It is equally good that you draw the spline by using the **Spline** tool directly without first creating construction points. To do so, at the end of the **Spline** tool, select **Open End with Fit Points** from the context menu. After dimensioning each point, use the **Spline Edit** tool to edit the spline and select **Re-fit Spline** [4] from the context menu to smooth out the spline. ↗

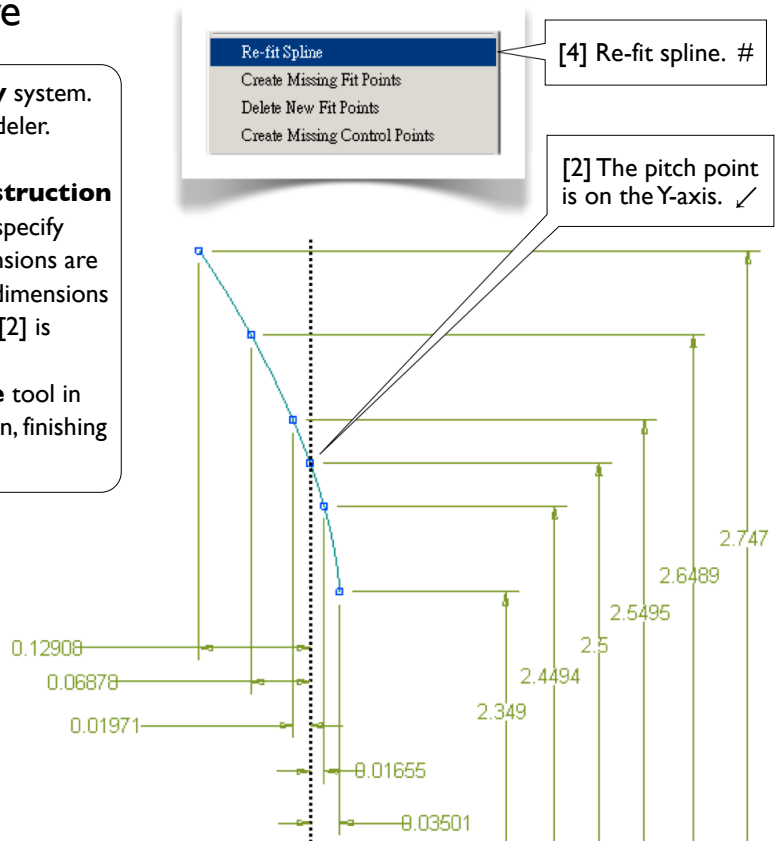

2.5.4 Draw Circles

[1] Using the **Circle** tool in the **Draw** toolbox, draw three circles as shown in [2-4]. Note that the radius of the addendum circle [4] is defined by clicking the outermost construction point. Specify radii for the shaft circle (1.25 in) and the dedendum circle (2.2 in). ↓

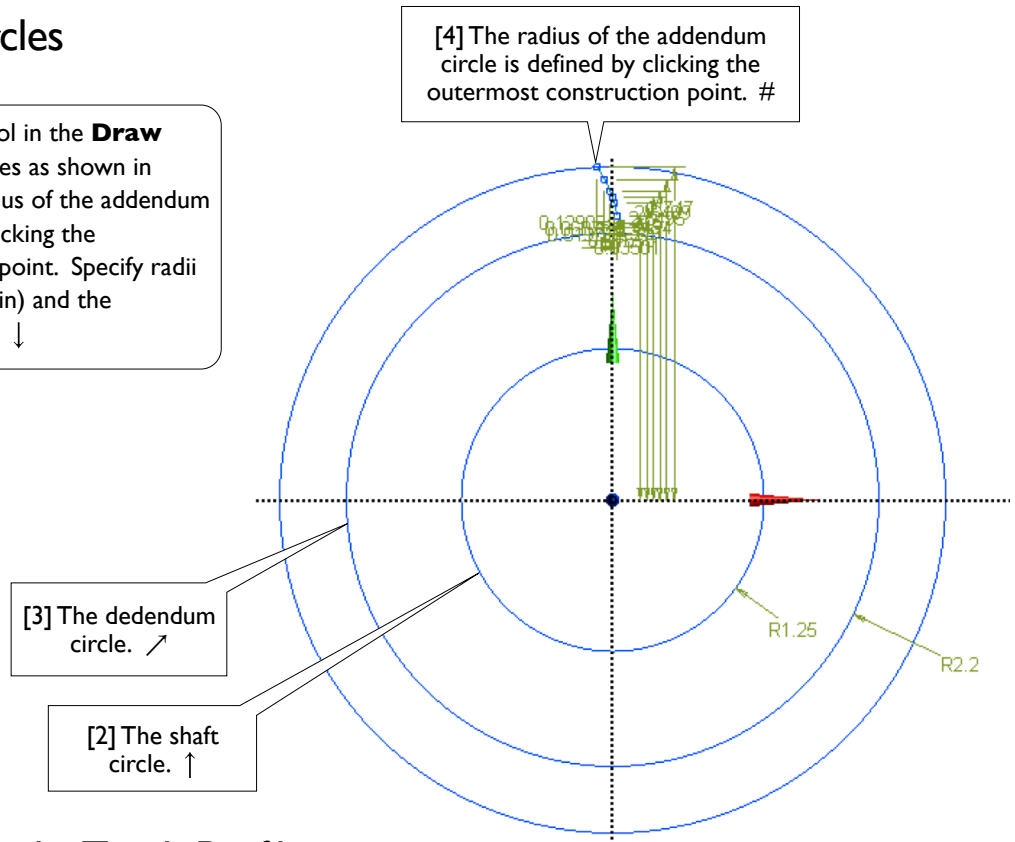

2.5.5 Complete the Tooth Profile

[1] Draw a line from the lowest construction point [2] to the dedendum circle [3], and make it perpendicular to the dedendum circle by using the **Perpendicular** tool in the **Constraints** toolbox [4]. When drawing the line, avoid a **V** auto-constraint (since this line is NOT vertical). Create a fillet of radius 0.1 inches as shown in [5]. This completes the profile of a tooth. →

[6] Sometimes, turning off **Display Plane** may be helpful when working on the graphics window [7]. In this case, all the dimensions referring to the plane axes disappear. ↓

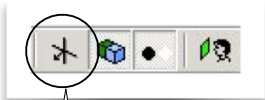

[7] Turn off **Display Plane** to clear up the graphics window. #

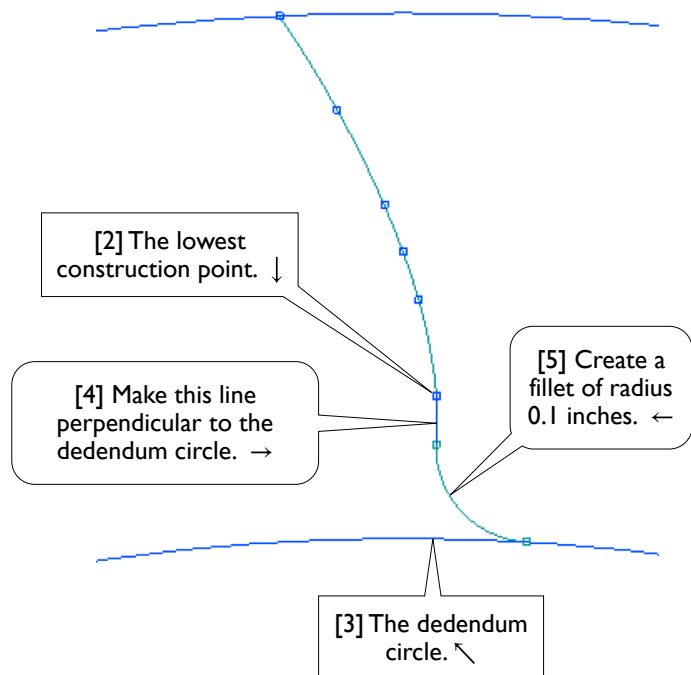

2.5.6 Replicate the Tooth Profile

[1] Select the **Replicate** tool, type 9 (degrees) for **r**. Select the tooth profile (3 segments in total), **End/Use Plane Origin as Handle, Flip Horizontal, Rotate by r**, and **Paste at Plane Origin** [2]. End the **Replicate** tool by pressing **ESC**.

Note that the gear has 20 teeth, each spanning 18 degrees. The angle between the two pitch points [3] is 9 degrees. →

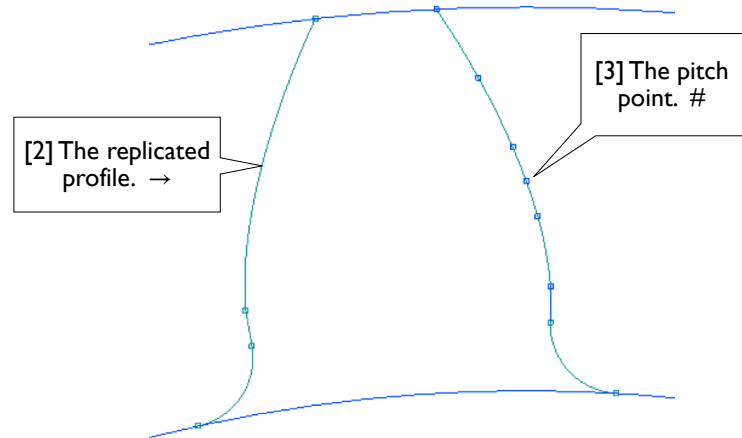

2.5.7 Replicate the Tooth 19 Times

[1] Click the **Replicate** tool again, type 18 (degrees) for **r**. Select both left and right profiles (6 segments in total), **End/Use Plane Origin as Handle, Rotate by r**, and **Paste at Plane Origin**. Repeat the last two steps (rotate and paste) until completing a full circle (20 teeth in total). #

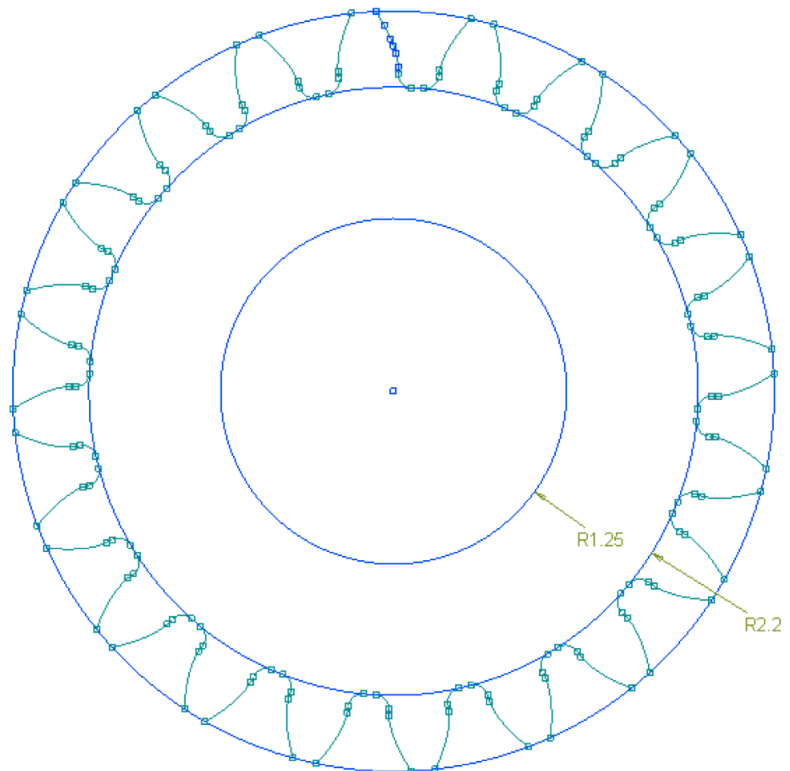

2.5.8 Trim Away Unwanted Segments

[1] Trim away unwanted segments in the addendum circle and the dedendum circle, as shown. #

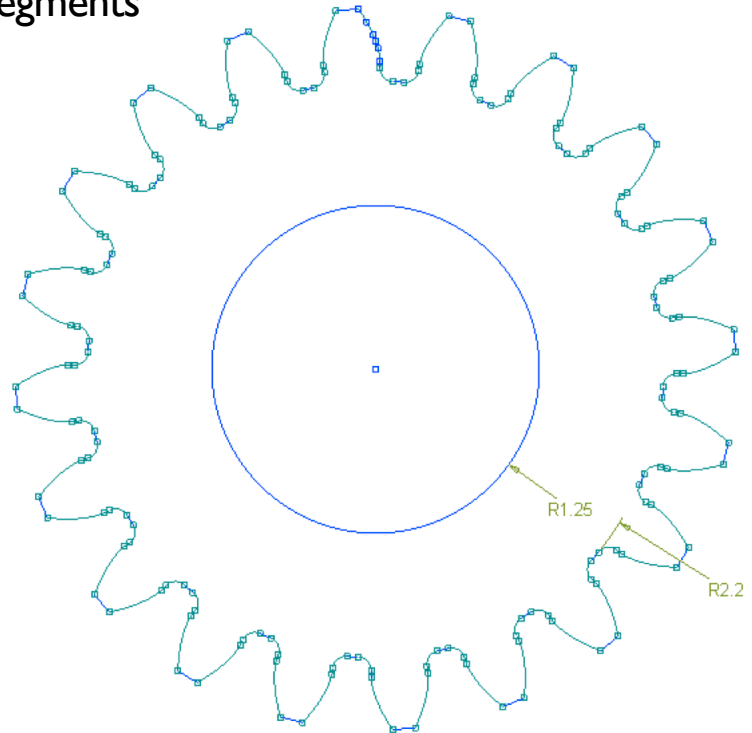

2.5.9 Extrude to Create 3D Solid

[1] Extrude the sketch 1.0 inch to create a 3D solid. Save the project and exit from Workbench. We will resume this project in Section 3.4. ↓

[2] It is equally good that you create a single tooth (a 3D solid body) and then duplicate it by using **Create/Pattern** in the **Modeling** mode. In this exercise, however, we use **Replicate** in **Sketching** mode because our focus in this chapter is to practice sketching techniques. #

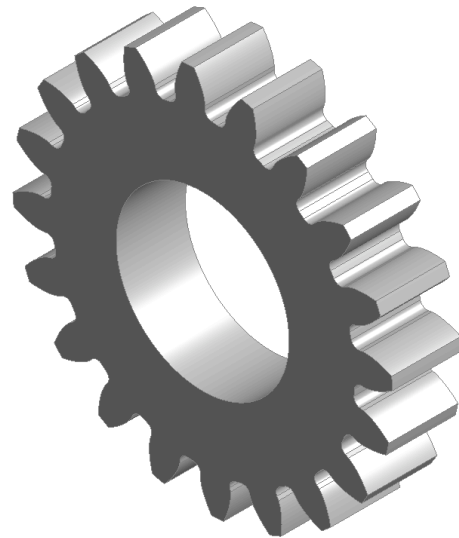

References

1. Deutschman, A. D., Michels, W. J., and Wilson, C. E., *Machine Design: Theory and Practice*, Macmillan Publishing Co., Inc., 1975; Chapter 10. Spur Gears.
2. Zahavi, E., *The Finite Element Method in Machine Design*, Prentice-Hall, 1992; Chapter 9. Spur Gears.

Section 2.6

Microgripper

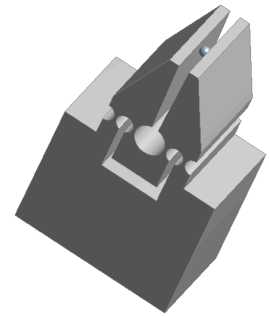

2.6.1 About the Microgripper^[Refs 1, 2]

[1] The microgripper is made of a rubber-like polymer material and actuated by a shape memory alloy (SMA) actuator [2-4]. The motion of the SMA is caused by temperature change, which is controlled by electric current. In the lab, the microgripper is tested by gripping a steel bead of a diameter of 30 micrometers [5].

In this section, we will create a solid model for the microgripper. The model will be used for simulation in Section 13.3 to assess the gripping forces on the bead with an actuation force of the SMA actuator. ↓

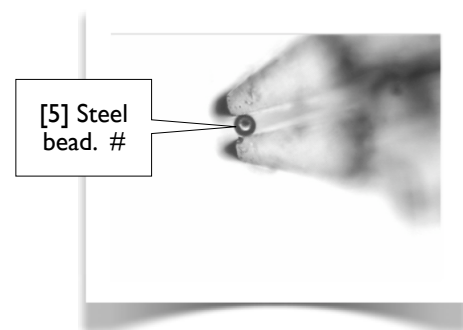
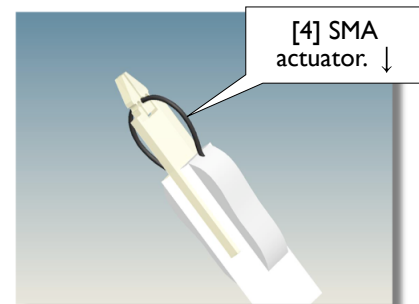
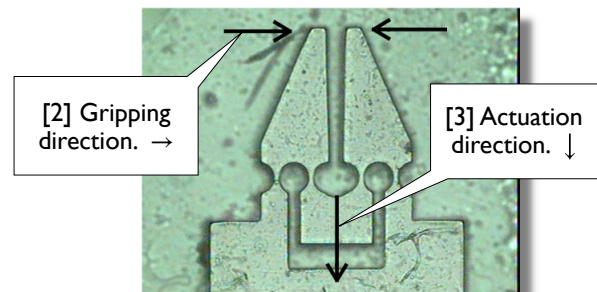
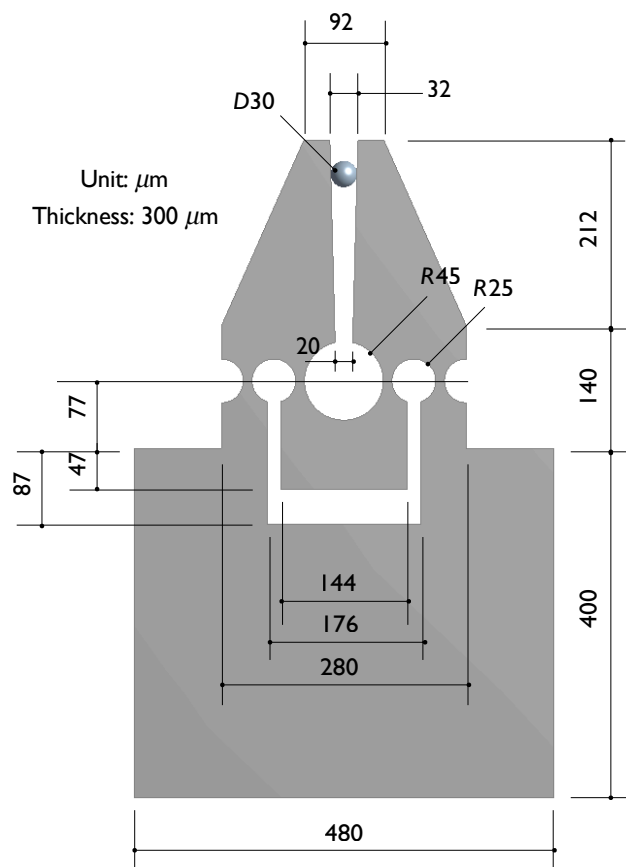

2.6.2 Create Half of the Gripper

[1] Launch Workbench. Create a **Geometry** system. Save the project as **Microgripper**. Start up DesignModeler. Select **Micrometer** as the length unit.

Draw a sketch on **XYPlane** as shown in [2]. Trim away unwanted segments [3]. Note that we drew only half of the model, due to the symmetry. Extrude the sketch 150 μm both sides symmetrically (the total depth is 300 μm) [4]. We now have a half of the gripper [5]. ↓

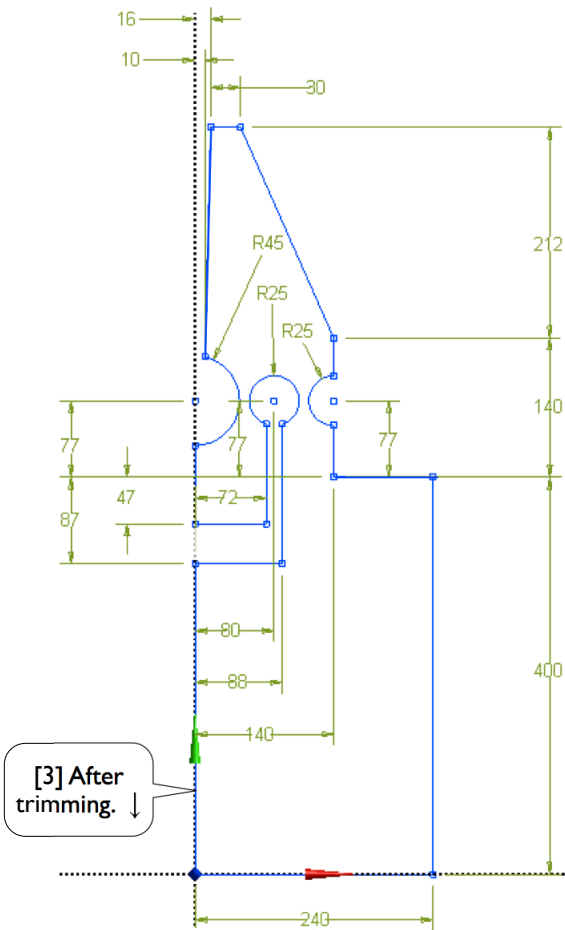

[3] After trimming. ↓

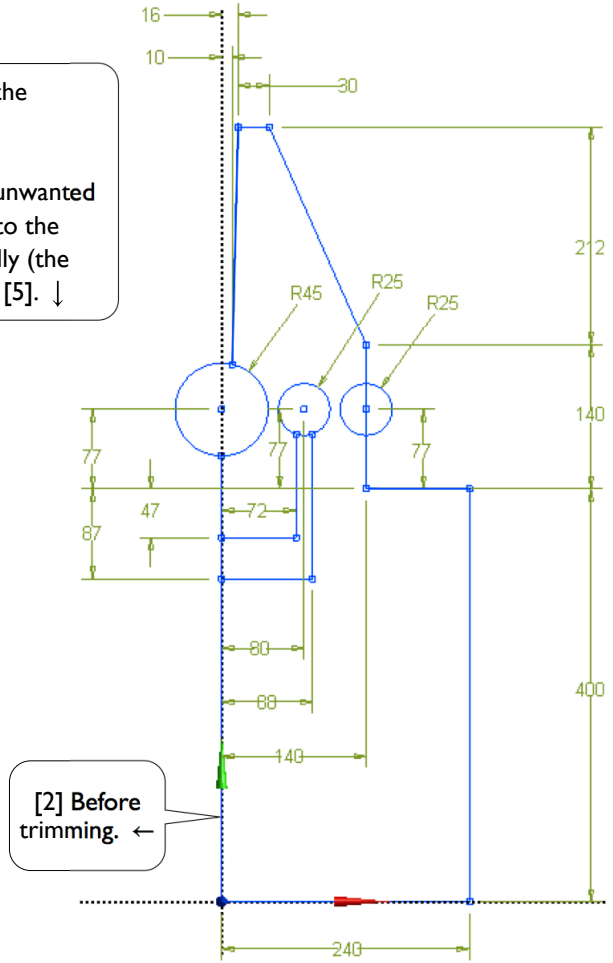

[2] Before trimming. ←

Details View	
Details of Extrude1	
Extrude	Extrude1
Geometry	Sketch1
Operation	Add Material
Direction Vector	None (Normal)
Direction	Both - Symmetric
Extent Type	Fixed
<input type="checkbox"/> FD1, Depth (>0)	150 μm
As Thin/Surface?	No
Merge Topology?	Yes

[4] Extrude the sketch both sides symmetrically. →

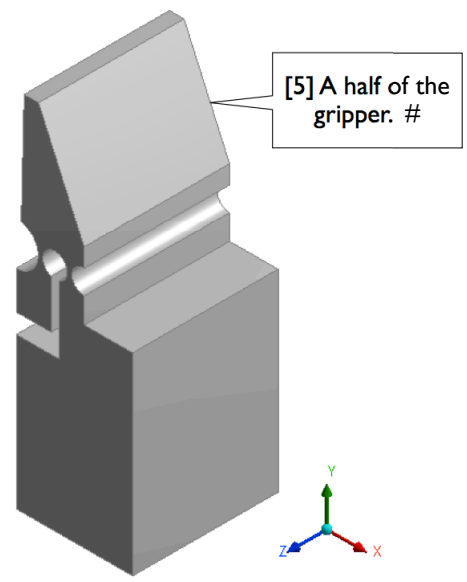

[5] A half of the gripper. #

2.6.3 Mirror Copy the Solid Body

[1] Pull-down-select **Create/Body Transformation/Mirror**. ↗

[2] In the graphics window, select the solid body and click **Apply**. ↑

Details of Mirror1	
Mirror	Mirror1
Preserve Bodies?	Yes
Mirror Plane	Not selected
Bodies	1

[3] Click this yellow area to bring up the **Apply/Cancel** buttons. ↓

Details of Mirror1	
Mirror	Mirror1
Preserve Bodies?	Yes
Mirror Plane	YZPlane
Bodies	1

[4] In **Tree Outline**, select **YZPlane** and click **Apply**. ✓

[5] Click **Generate**. #

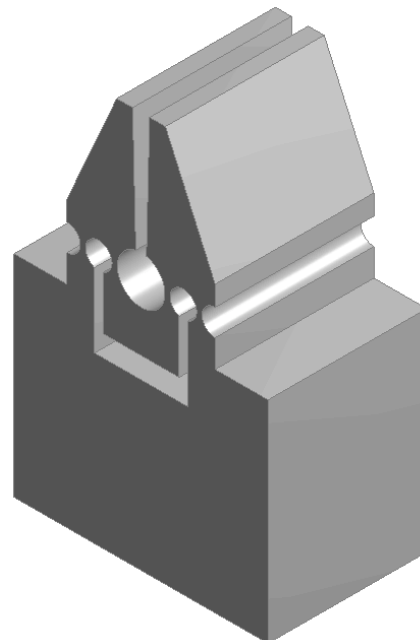

2.6.4 Create the Bead

[1] Create a new sketch on **XYPlane** as shown in [2-3] and draw a semicircle as shown in [4-7]. Revolve the sketch 360° about the Y-axis to create the bead [8]. Note that the two bodies are treated as two parts [9]. Rename the two bodies as **Gripper** and **Bead** respectively [10]. →

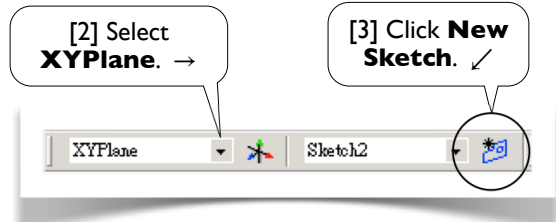

[4] The semicircle can be created by creating a full circle and then trimming it using the axis. ↓

[5] Close the sketch by drawing a vertical line. ↓

[8] **Revolve** the sketch about the Y-axis to create a sphere. ↓

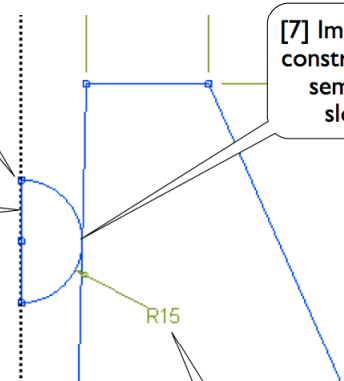
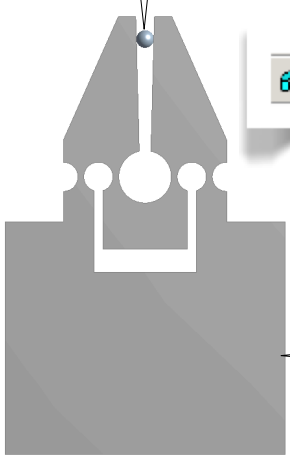

[9] The two bodies are treated as two parts (see [10]). ↗

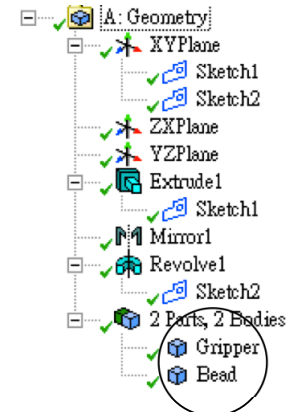

[10] Right-click to rename each body like this. ✓

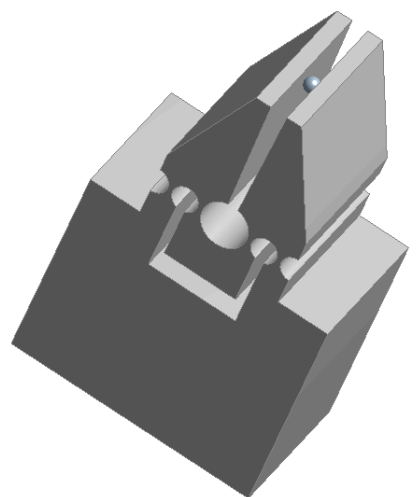

Wrap Up

[11] Close DesignModeler, save the project and exit Workbench. We will resume this project in Section 13.3. #

References

1. Chang, R. J., Lin, Y. C., Shiu, C. C., and Hsieh, Y. T., "Development of SMA-Actuated Microgripper in Micro Assembly Applications," IECON, IEEE, Taiwan, 2007.
2. Shih, P. W., *Applications of SMA on Driving Micro-gripper*, MS Thesis, NCKU, ME, Taiwan, 2005.

Section 2.7

Review

2.7.1 Keywords

Choose a letter for each keyword, from the list of descriptions

- | | |
|--------------------------|--------------------------|
| 1. () Auto Constraints | 8. () Object |
| 2. () Branch | 9. () Paste Handle |
| 3. () Constraint Status | 10. () Sketching Mode |
| 4. () Context Menu | 11. () Sketching Plane |
| 5. () Edge | 12. () Sketch |
| 6. () Modeling Mode | 13. () Selection Filter |
| 7. () Model Tree | |

Answers:

1. (J) 2. (G) 3. (M) 4. (I) 5. (D) 6. (B) 7. (F) 8. (H)
 9. (L) 10. (A) 11. (C) 12. (E) 13. (K)

List of Descriptions

- (A) An environment under DesignModeler; its function is to draw sketches on a plane.
- (B) An environment under DesignModeler; its function is to create 3D or 2D bodies.
- (C) The plane on which a sketch is created. Each sketch must be associated with a plane; each plane may have multiple sketches on it. Usage of planes is not limited for storing sketches.
- (D) In **Sketching** mode, it may be a (straight) line or a curve. A curve may be a circle, ellipse, arc, or spline.
- (E) It consists of points and edges. Dimensions and constraints may be imposed on these entities.
- (F) It is the structured representation of a geometry and displayed on **Tree Outline** in **DesignModeler**. It consists of features and a part branch; their order is important. The parts are the only objects exported to **Mechanical**.

- (G) An object of a model tree and consists of one or more objects under itself.
- (H) A leaf or branch of a model tree.
- (I) The menu that pops up when you right-click your mouse. The contents of the menu depend on what you click.
- (J) While drawing in **Sketching** mode, by default, DesignModeler attempts to detect the user's intentions and tries to automatically impose constraints on points or edges. Detection is performed over entities on the active plane, not just active sketch. It can be switched on/off in the **Constraints** toolbox.
- (K) It filters one type of geometric entity. When it is turned on/off, the corresponding type of entity becomes selectable/unselectable. In **Sketching** mode, there are two selection filters, namely points and edges filters. Along with these two filters, face and body selection filters are available in **Modeling** mode.
- (L) A reference point used in a copy/paste operation. The point is defined during copying and will coincide with a specified location when pasting.
- (M) In **Sketching** mode, entities are color coded to indicate their constraint status: greenish-blue for under-constrained; blue and black for well constrained (i.e., fixed in the space); red for over-constrained; gray for inconsistent.

2.7.2 Additional Workbench Exercises

Create Geometric Models with Your Own Way

After so many exercises, you should be able to figure out many alternative ways of creating the geometric models in this chapter. Try to re-create the models in this chapter using your own way.