

Parametric Modeling with SOLIDWORKS® 2021

Covers materials found on the CSWA exam

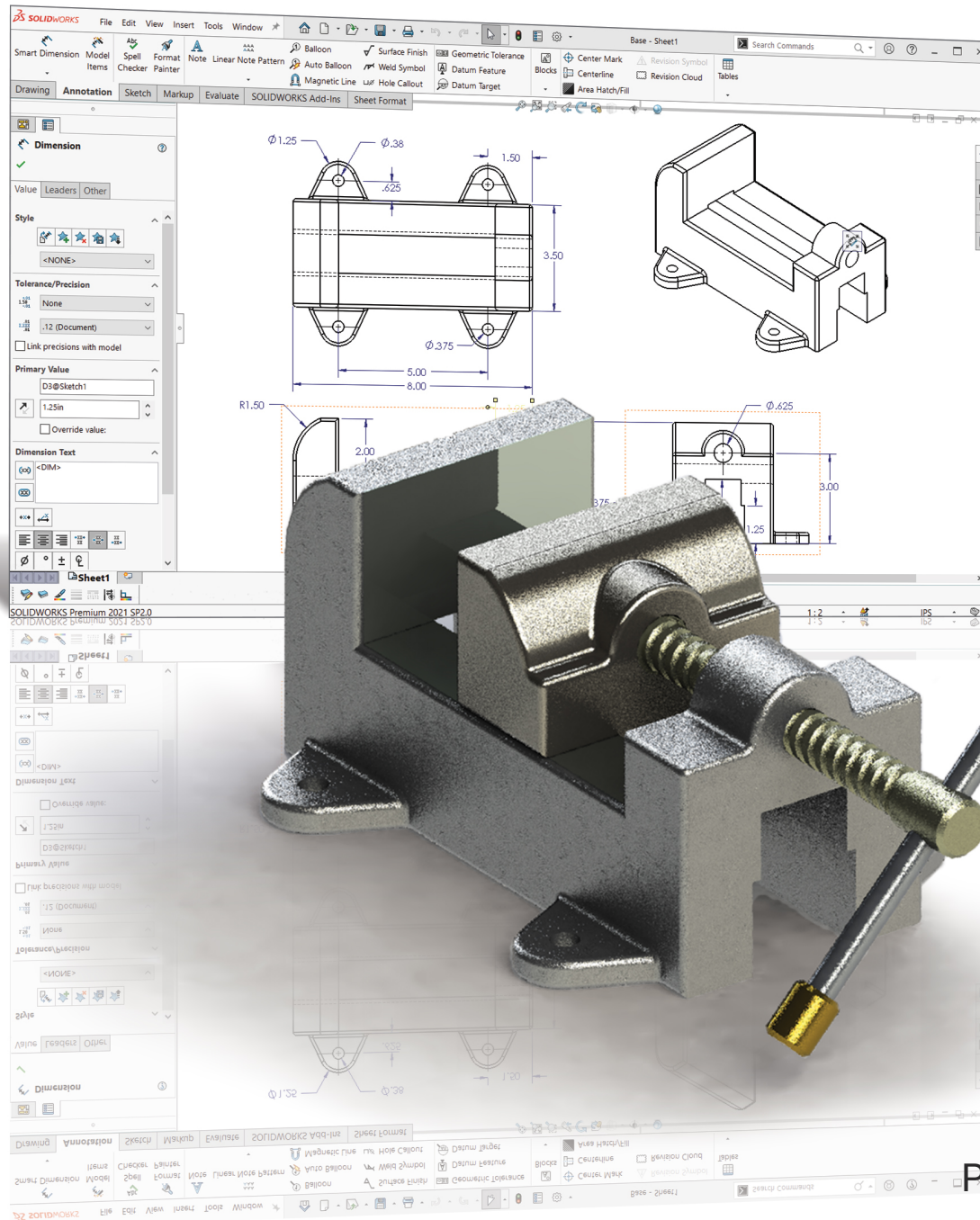

Randy H. Shih

Paul J. Schilling

Visit the following websites to learn more about this book:



[amazon.com](https://www.amazon.com)

[Google books](https://books.google.com)

[BARNES & NOBLE](https://www.barnesandnoble.com)

Chapter 2

Parametric Modeling Fundamentals

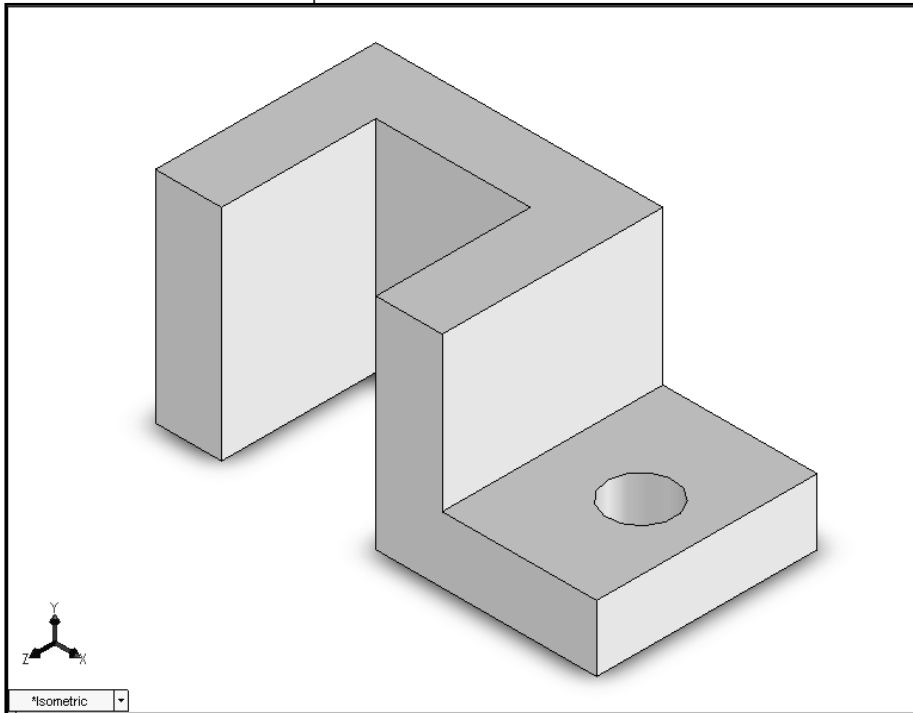

Learning Objectives

- ◆ Create Simple Extruded Solid Models
- ◆ Understand the Basic Parametric Modeling Procedure
- ◆ Create 2-D Sketches
- ◆ Understand the “Shape before Size” Approach
- ◆ Use the Dynamic Viewing Commands
- ◆ Create and Edit Parametric Dimensions

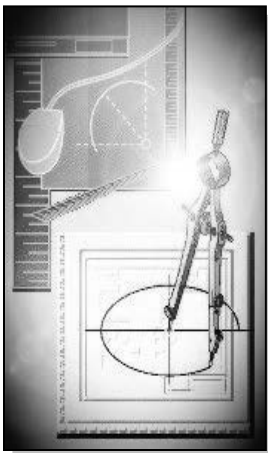

Certified SOLIDWORKS Associate Exam Objectives Coverage

Sketch Entities – Lines, Rectangles, Circles, Arcs, Ellipses, Centerlines

Objectives: Creating Sketch Entities.

| | |
|---|------|
| Sketch Command | 2-8 |
| Line Command..... | 2-8 |
| Exit Sketch | 2-14 |
| Circle Command, Center Point Circle | 2-29 |

Sketch Relations

Objectives: Using Geometric Relations.

| | |
|--|------|
| Horizontal Relation..... | 2-9 |
| Geometric Relation Symbols | 2-10 |
| Preventing Relations with [Ctrl] Key | 2-11 |
| View Sketch Relations..... | 2-17 |

Boss and Cut Features – Extrudes, Revolves, Sweeps, Lofts

Objectives: Creating Basic Swept Features.

| | |
|---------------------------------|------|
| Extruded Boss/Base, Blind | 2-15 |
| Merge Result Option..... | 2-28 |
| Extruded Cut | 2-30 |
| Extruded Cut, Through All | 2-30 |

Dimensions

Objectives: Applying and Editing Smart Dimensions.

| | |
|---------------------------------|------|
| Dimension, Smart Dimension..... | 2-11 |
| Dimension Standard..... | 2-12 |
| Dimension, Modify | 2-14 |

Feature Conditions – Start and End

Objectives: Controlling Feature Start and End Conditions.

| | |
|---------------------------------|------|
| Extruded Boss/Base, Blind | 2-15 |
| Extruded Cut, Through All | 2-30 |

Introduction

The **feature-based parametric modeling** technique enables the designer to incorporate the original **design intent** into the construction of the model. The word *parametric* means the geometric definitions of the design, such as dimensions, can be varied at any time in the design process. Parametric modeling is accomplished by identifying and creating the key features of the design with the aid of computer software. The design variables, described in the sketches as parametric relations, can then be used to quickly modify/update the design.

In SOLIDWORKS, the parametric part modeling process involves the following steps:

1. **Create a rough two-dimensional sketch of the basic shape of the base feature of the design.**
2. **Apply/modify geometric relations and dimensions to the two-dimensional sketch.**
3. **Extrude, revolve, or sweep the parametric two-dimensional sketch to create the base solid feature of the design.**
4. **Add additional parametric features by identifying feature relations and complete the design.**
5. **Perform analyses on the computer model and refine the design as needed.**
6. **Create the desired drawing views to document the design.**

The approach of creating two-dimensional sketches of the three-dimensional features is an effective way to construct solid models. Many designs are in fact the same shape in one direction. Computer input and output devices we use today are largely two-dimensional in nature, which makes this modeling technique quite practical. This method also conforms to the design process that helps the designer with conceptual design along with the capability to capture the *design intent*. Most engineers and designers can relate to the experience of making rough sketches on restaurant napkins to convey conceptual design ideas. SOLIDWORKS provides many powerful modeling and design-tools, and there are many different approaches to accomplishing modeling tasks. The basic principle of **feature-based modeling** is to build models by adding simple features one at a time. In this chapter, the general parametric part modeling procedure is illustrated; a very simple solid model with extruded features is used to introduce the SOLIDWORKS user interface. The display viewing functions, and the basic two-dimensional sketching tools are also demonstrated.

The Adjuster Design

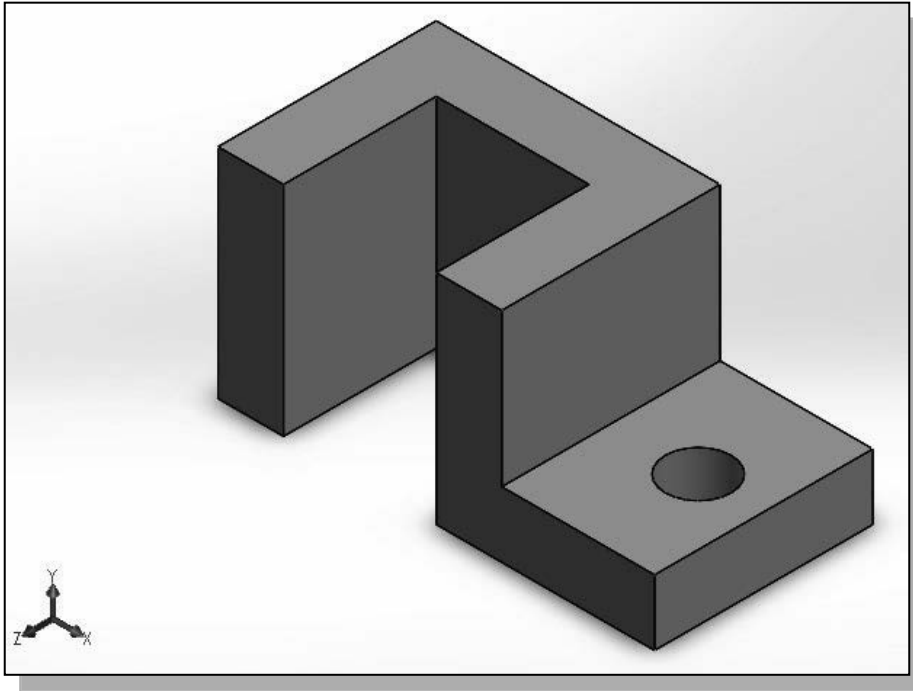

Starting SOLIDWORKS



1. Select the **SOLIDWORKS** option on the *Start* menu or select the **SOLIDWORKS** icon on the desktop to start SOLIDWORKS. The SOLIDWORKS main window will appear on the screen.

➤ We will start a new SOLIDWORKS part file using the *Welcome* dialog box.



2. If the *Welcome* dialog box does not appear automatically upon opening SOLIDWORKS, it can be opened by clicking the *Welcome to SolidWorks* icon in the *Task Pane* or on the *Menu Bar*.

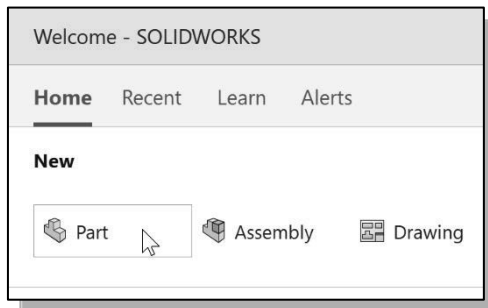

3. Select the **Part** icon with a single click of the left-mouse-button in the *Welcome* dialog box to open a new part document.

SOLIDWORKS Screen Layout

The default SOLIDWORKS drawing screen contains the *Menu Bar*, the *Heads-up View* toolbar, the *FeatureManager Design Tree*, the *Features* toolbar (at the left of the window by default), the *Sketch* toolbar (at the right of the window by default), the graphics area, the *task pane* (collapsed to the right of the graphics area in the figure below), and the *Status Bar*. A line of quick text appears next to the icon as you move the *mouse cursor* over different icons. You may resize the SOLIDWORKS drawing window by clicking and dragging at the edges of the window, or relocate the window by clicking and dragging at the *window title* area.

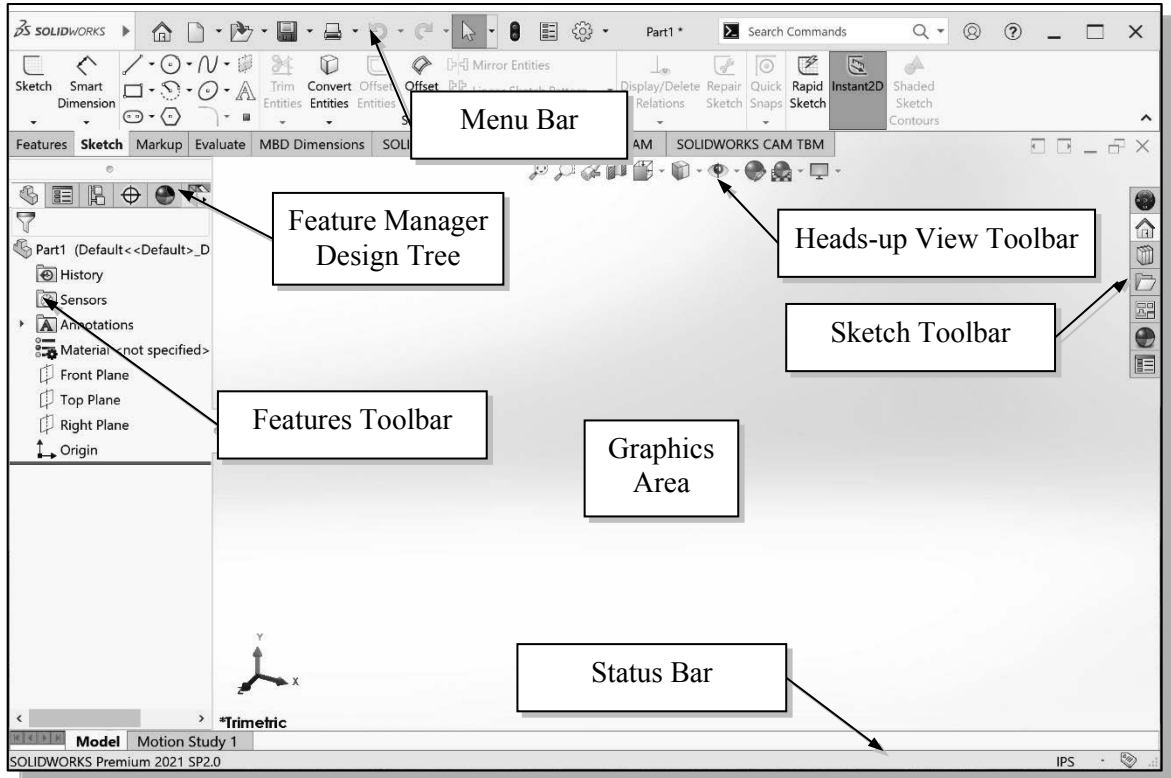

IMPORTANT NOTE: The SOLIDWORKS *CommandManager* provides an alternate method for displaying the most commonly used toolbars. If the *CommandManager* is active, the display will appear as shown on page 1-11. In this lesson, we will use the standard display of toolbars shown above. If a user prefers to use the *CommandManager*, the only change is that it may be necessary to select the appropriate tab prior to selecting a command. For example, if the instruction is to “select the Extruded Boss command from the *Features* toolbar,” it may be necessary to first select the *Features* tab on the *CommandManager* to display the *Features* toolbar.

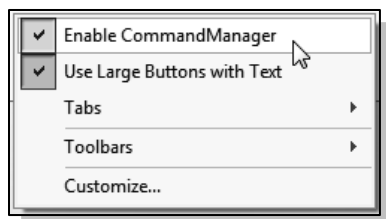

1. To turn **OFF** the *CommandManager* and use the standard display of toolbars, right click on the *CommandManager* (or any other toolbar) and toggle the *CommandManager OFF* by selecting it at the top of the pop-up menu.

Units Setup

When starting a new CAD file, the first thing we should do is choose the units we would like to use. The *Unit system* for the active document can be changed or customized using the **System Units** option on the *Status Bar* at the bottom of the SOLIDWORKS window. We will use English units (inches, pounds) for this example.

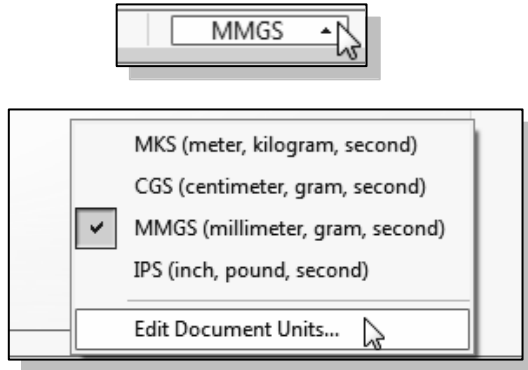

1. If the default *Unit system* is set to millimeter, gram, second, the *System Units* icon on the *Status Bar* displays **MMGS**. Click on the *System Units* icon to reveal additional options.
2. Select the **Edit Document Units** option as shown. This will open the **Document Properties - Units** dialog box.

3. Select **IPS (inch, pound, second)** under the *Unit system* options.
4. Select **.123** in the *Decimals* spin box for the *Length units* as shown to define the degree of accuracy with which the units will be displayed to 3 decimal places.

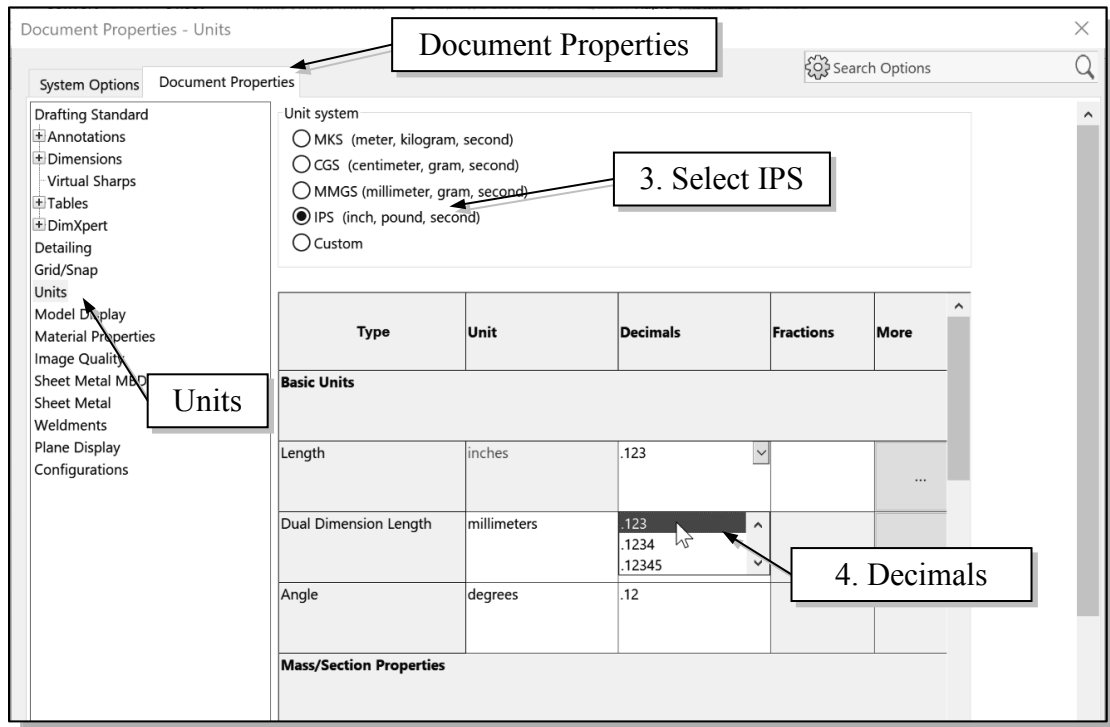

5. Click **OK** in the *Options* dialog box to accept the selected settings.

Creating Rough Sketches

Quite often during the early design stage, the shape of a design may not have any precise dimensions. Most conventional CAD systems require the user to input the precise lengths and locations of all geometric entities defining the design, which are not available during the early design stage. With *parametric modeling*, we can use the computer to elaborate and formulate the design idea further during the initial design stage. With SOLIDWORKS, we can use the computer as an electronic sketchpad to help us concentrate on the formulation of forms and shapes for the design. This approach is the main advantage of *parametric modeling* over conventional solid-modeling techniques.

As the name implies, a **rough sketch** is not precise at all. When sketching, we simply sketch the geometry so that it closely resembles the desired shape. Precise scale or lengths are not needed. SOLIDWORKS provides us with many tools to assist us in finalizing sketches. For example, geometric entities such as horizontal and vertical lines are set automatically. However, if the rough sketches are poor, it will require much more work to generate the desired parametric sketches. Here are some general guidelines for creating sketches in SOLIDWORKS:

- **Create a sketch that is proportional to the desired shape.** Concentrate on the shapes and forms of the design.
 - **Keep the sketches simple.** Leave out small geometry features such as fillets, rounds and chamfers. They can easily be placed using the **Fillet** and **Chamfer** commands after the parametric sketches have been established.
 - **Exaggerate the geometric features of the desired shape.** For example, if the desired angle is 85 degrees, create an angle that is 50 or 60 degrees. Otherwise, SOLIDWORKS might assume the intended angle to be a 90-degree angle.
 - **Draw the geometry so that it does not overlap.** The geometry should eventually form a closed region. *Self-intersecting* geometry shapes are not allowed.
 - **The sketched geometric entities should form a closed region.** To create a solid feature, such as an extruded solid, a closed region is required so that the extruded solid forms a 3D volume.
- **NOTE:** The concepts and principles involved in *parametric modeling* are very different from, and sometimes they are totally opposite to, those of conventional computer aided drafting. In order to understand and fully utilize SOLIDWORKS' functionality, it will be helpful to take a *Zen* approach to learning the topics presented in this text: **Temporarily forget your knowledge and experiences of using conventional Computer Aided Drafting systems.**

Step 1: Creating a Rough Sketch

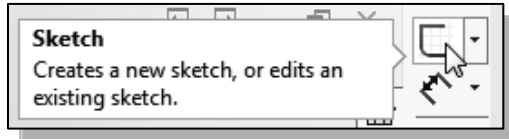

1. Select the **Sketch** button at the top of the *Sketch* toolbar to create a new sketch.

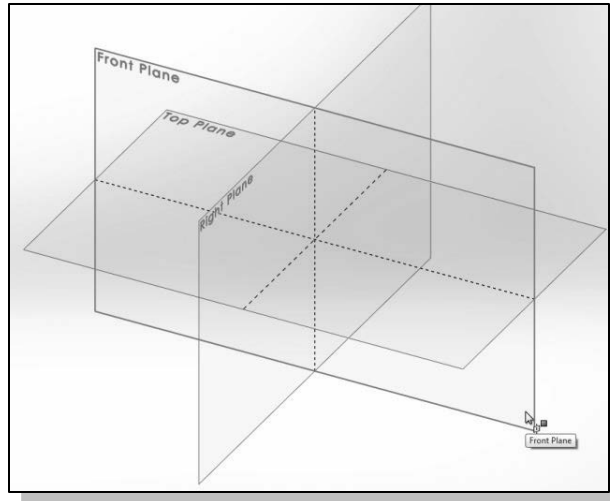

2. Notice the left panel displays the *Edit Sketch PropertyManager* with the instruction “*Select a plane on which to create a sketch for the entity.*” Move the cursor over the edge of the *Front Plane* in the graphics area. When the *Front Plane* is highlighted, click once with the **left-mouse-button** to select the *Front Plane* as the sketch plane for the new sketch.

3. Move the cursor over the **Line** icon on the *Sketch* toolbar, but do not click. Notice that a description of the Line command appears along with an animation of the execution of the command.

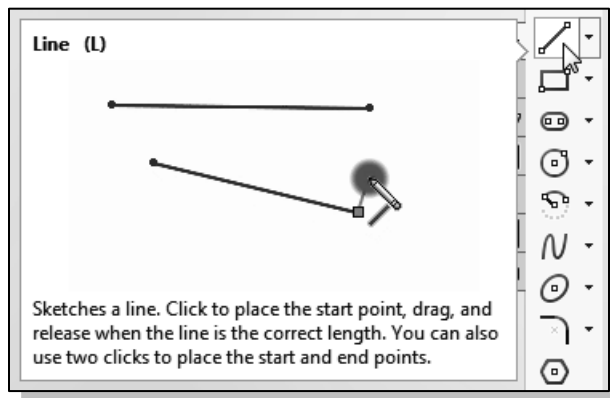

4. Select the **Line** icon on the *Sketch* toolbar by clicking once with the **left-mouse-button**; this will activate the Line command. The *Line Properties PropertyManager* is displayed in the left panel.

Graphics Cursors

Notice the cursor changes from an arrow to a pencil when a sketch entity is active.

1. Left-click a starting point for the shape, roughly near the lower center of the graphics window.
2. As you move the graphics cursor, you will see a digital readout next to the cursor. This readout gives you the line length. In the *Status Bar* area at the bottom of the window, the readout gives you the cursor location. Move the cursor around and you will notice different symbols appear at different locations.

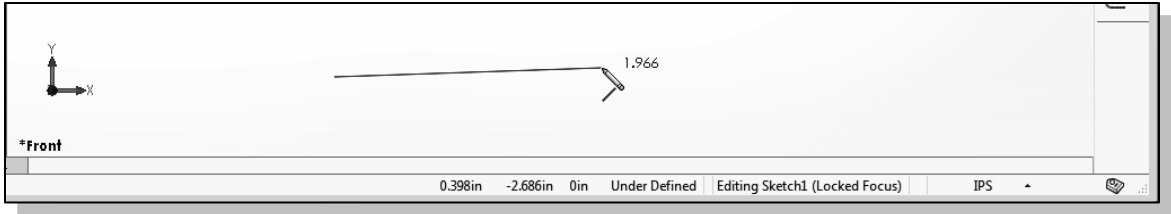

3. Move the graphics cursor toward the right side of the graphics window to create a horizontal line as shown below. Notice the geometric relation symbol displayed. When the **Horizontal** relation symbol is displayed, left-click to select **Point 2**.

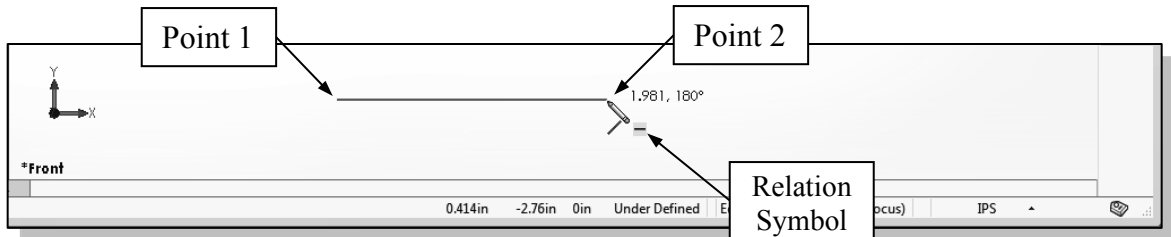

4. Complete the sketch as shown below, creating a closed region **ending at the starting point** (Point 1). Do not be overly concerned with the actual size of the sketch. Note that all line segments are sketched horizontally or vertically.

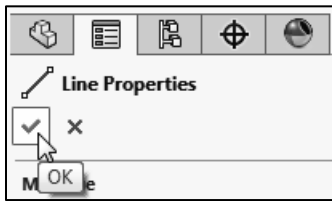
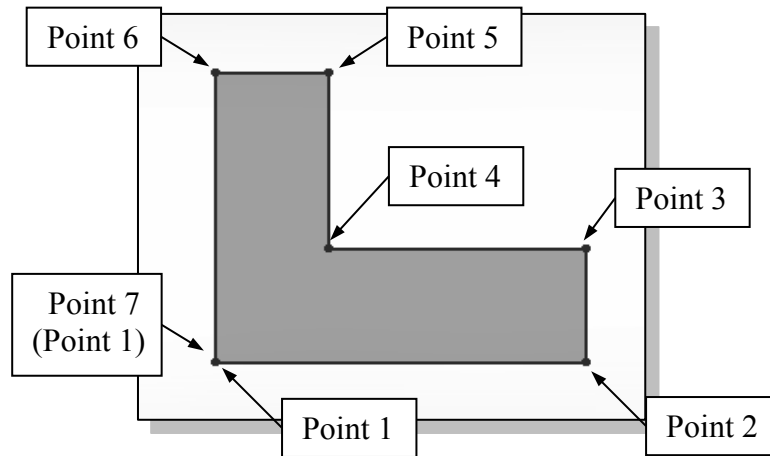

5. Click the **OK** icon (green check mark) in the *PropertyManager* to end editing of the current line, then click the **OK** icon again to end the **Sketch Line** command, or hit the **[Esc]** key once to end the **Sketch Line** command.

Geometric Relation Symbols

SOLIDWORKS displays different visual clues, or symbols, to show you alignments, perpendicularities, tangencies, etc. These relations are used to capture the *design intent* by creating relations where they are recognized. SOLIDWORKS displays the governing geometric rules as models are built. To prevent relations from forming, hold down the [Ctrl] key while creating an individual sketch curve. For example, while sketching line segments with the Line command, endpoints are joined with a *Coincident relation*, but when the [Ctrl] key is pressed and held, the inferred relation will not be created.

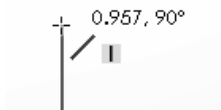

Vertical

indicates a line is vertical

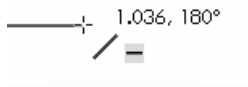

Horizontal

indicates a line is horizontal

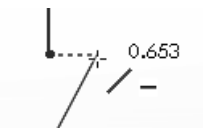

Dashed line

indicates the alignment is to the center point or endpoint of an entity

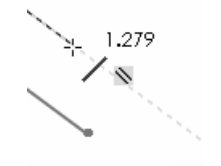

Parallel

indicates a line is parallel to other entities

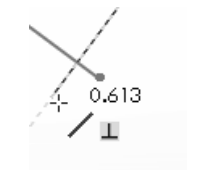

Perpendicular

indicates a line is perpendicular to other entities

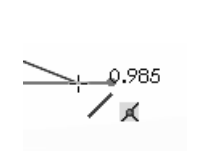

Coincident

indicates the endpoint will be coincident with another entity



Concentric

indicates the cursor is at the center of an entity

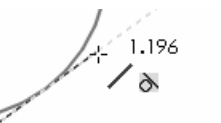

Tangent

indicates the cursor is at tangency points to curves

Step 2: Apply/Modify Relations and Dimensions

As the sketch is made, SOLIDWORKS automatically applies some of the geometric relations (such as Horizontal, Parallel, and Perpendicular) to the sketched geometry. We can continue to modify the geometry, apply additional relations, and/or define the size of the existing geometry. In this example, we will illustrate adding dimensions to describe the sketched entities.



1. Move the cursor on top of the Smart Dimension icon on the *Sketch* toolbar. The **Smart Dimension** command allows us to quickly create and modify dimensions. Left-click once on the icon to activate the **Smart Dimension** command.

2. The message “*Select one or two edges/vertices and then a text location*” is displayed in the *Status Bar* area at the bottom of the SOLIDWORKS window. Select the bottom horizontal line by left-clicking once on the line.

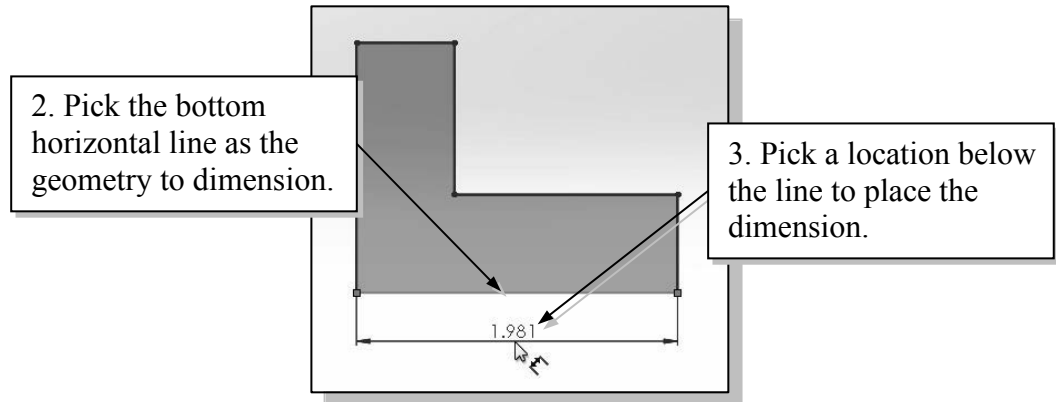

3. Move the graphics cursor below the selected line and left-click to place the dimension. (Note that the value displayed on your screen might be different than what is shown in the figure above.)

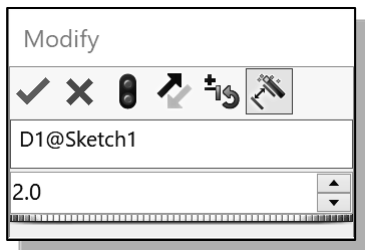

4. Enter **2.0** in the *Modify* dialog box.
5. Left click the **OK** (green check mark) in the *Modify* dialog box to save the current value and exit the dialog.
6. **On your own**, select the lower right-vertical line.

7. Pick a location toward the right of the sketch to place the dimension.
8. Enter **0.75** in the *Modify* dialog box.
9. Click **OK** in the *Modify* dialog box.

❖ The Smart Dimension command will create a length dimension if a single line is selected.

10. Select the top-horizontal line as shown below.
11. Select the bottom-horizontal line as shown below.

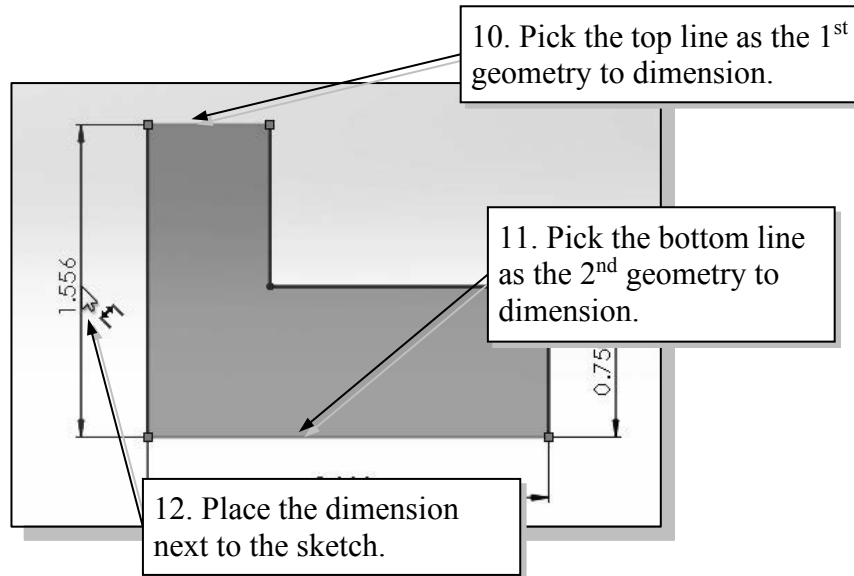

12. Pick a location to the left of the sketch to place the dimension.
13. Enter **2.0** in the *Modify* dialog box.
14. Click **OK** in the *Modify* dialog box.

❖ When two parallel lines are selected, the Smart Dimension command will create a dimension measuring the distance between them.

15. **On your own**, repeat the above steps and create an additional dimension for the top line. Make the dimension **0.75**.

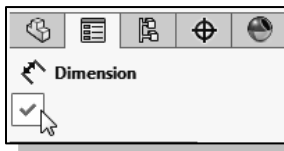

16. Click the **OK** icon in the *PropertyManager* as shown, or hit the **[Esc]** key once, to end the Smart Dimension command.

Changing the Dimension Standard



1. Select the **Options** icon from the *Menu Bar* to open the *Options* dialog box.

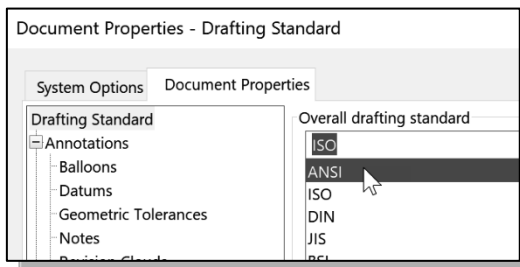

2. Select the **Document Properties** tab, then select **Drafting Standard** at the left.
3. Select **ANSI** in the pull-down selection window under the *Overall drafting standard* panel as shown.

4. Left-click **OK** in the *Options* dialog box to accept the settings.
- The sketch should now look as shown below. Notice the change in appearance of the dimensions.

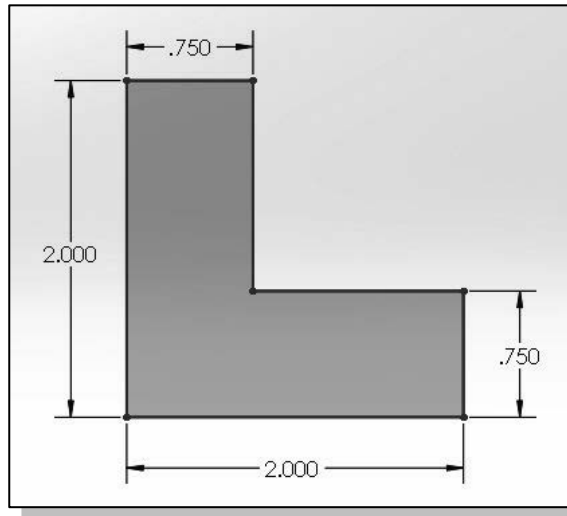

Viewing Functions – Zoom and Pan

SOLIDWORKS provides a special user interface that enables convenient viewing of the entities in the graphics window. There are many ways to perform the **Zoom** and **Pan** operations.

1. Hold the **Ctrl** function key down. While holding the **Ctrl** function key down, press the mouse wheel down and drag the mouse to **pan** the display. This allows you to reposition the display while maintaining the same scale factor of the display.
2. Hold the **Shift** function key down. While holding the **Shift** function key down, press the mouse wheel down and drag the mouse to **zoom** the display. Moving downward will reduce the scale of the display, making the entities display smaller on the screen. Moving upward will magnify the scale of the display.
3. Turning the mouse wheel can also adjust the scale of the display. Turn the mouse wheel forward. Notice the scale of the display is reduced, making the entities display smaller on the screen.
4. Turn the mouse wheel backward. Notice scale of the display is magnified. (**NOTE:** Turning the mouse wheel allows zooming to the position of the cursor.)
5. On your own, use the options above to change the scale and position of the display.
6. Press the **F** key on the keyboard to automatically fit the model to the screen.

Modifying the Dimensions of the Sketch

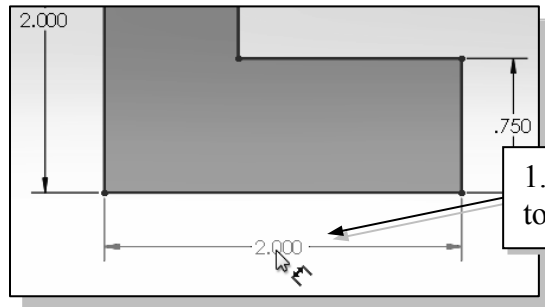

1. Select the dimension that is at the bottom of the sketch by **double-clicking** with the **left-mouse-button** on the dimension text.

1. Select this dimension to modify.

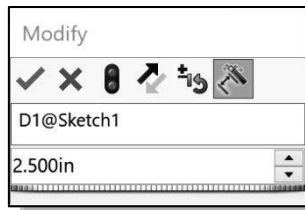

2. In the *Modify* window, the current length of the line is displayed. Enter **2.5** to reset the length of the line.
3. Click on the **OK** icon to accept the entered value.

➤ SOLIDWORKS will now update the profile with the new dimension value.

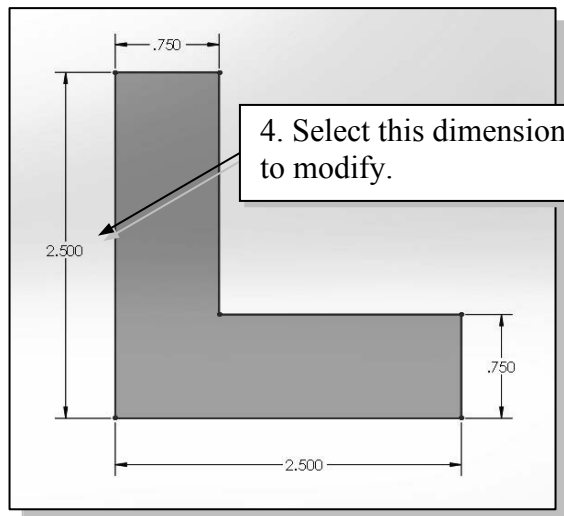

4. Select this dimension to modify.

4. **On your own**, repeat the above steps and adjust the left vertical dimension to **2.5** so that the sketch appears as shown.
5. Press the [**Esc**] key once to exit the Dimension command.

6. Click once with the **left-mouse-button** on the **Sketch** icon on the *Sketch* toolbar to exit the sketch.

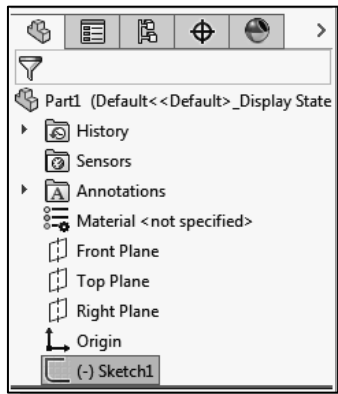
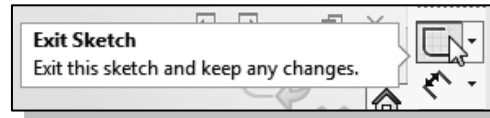

- Notice the newly created sketch is listed on the *Feature-Manager Design Tree* as **Sketch1**. Also notice that **Sketch1** is highlighted in the *Design Tree*, indicating that the sketch is currently 'selected'.

Step 3: Completing the Base Solid Feature

Now that the 2D sketch is completed, we will proceed to the next step: creating a 3D part from the 2D profile. Extruding a 2D profile is one of the common methods that can be used to create 3D parts. We can extrude planar faces along a path. We can also specify a height value and a tapered angle.

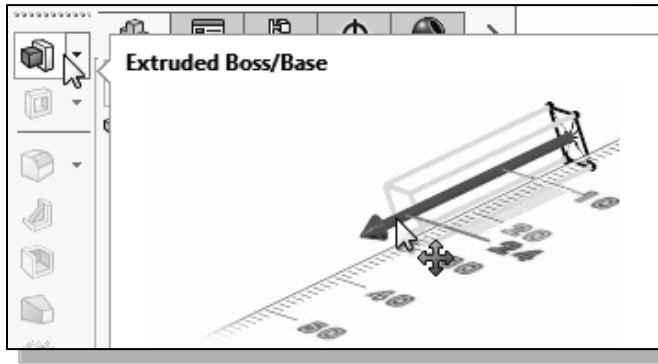

1. In the *Features* toolbar (located at the left of the window), select the **Extruded Boss/Base** command by clicking once with the left-mouse-button on the icon. The *Boss Extrude Property-Manager* is displayed in the left panel.

2. In the *Boss Extrude PropertyManager* panel, enter **2.5** as the extrusion distance. Notice that the sketch region is automatically selected as the extrusion profile.

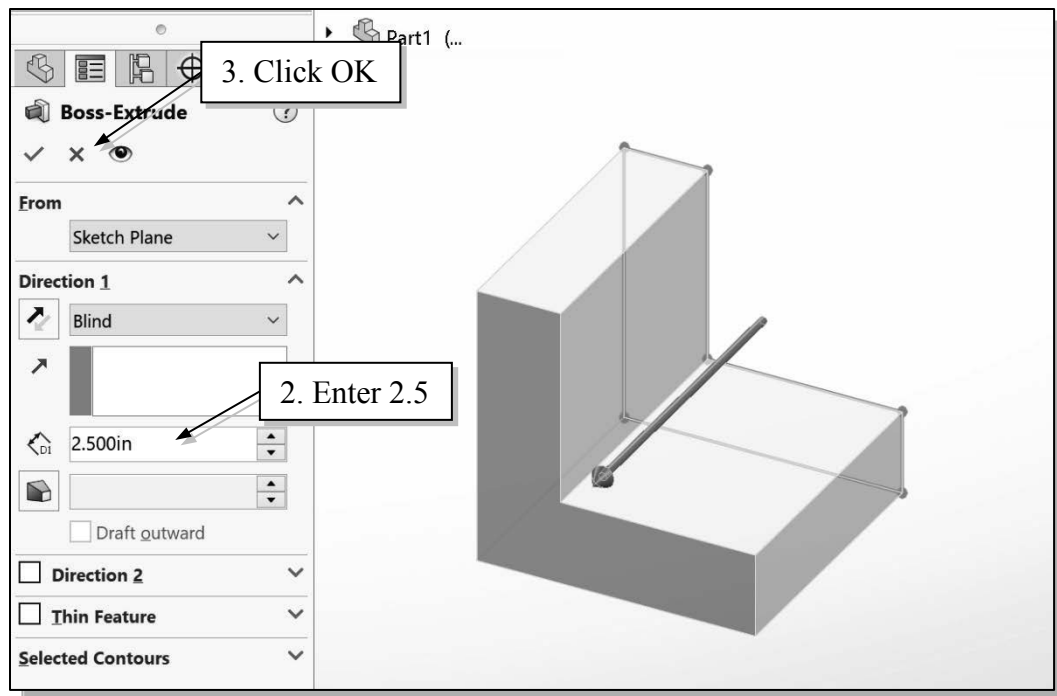

3. Click on the **OK** button to proceed with creating the 3D part.
- Note that all dimensions disappeared from the screen. All parametric definitions are stored in the **SOLIDWORKS database** and any of the parametric definitions can be displayed and edited at any time.

Isometric View

SOLIDWORKS provides many ways to display views of the three-dimensional design. We will first orient the model to display in the *isometric view*, by using the *View Orientation* pull-down menu on the *Heads-up View* toolbar.

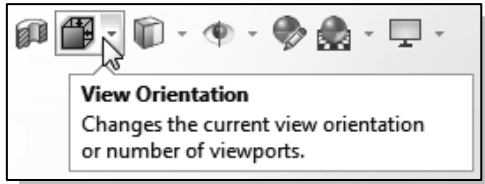

1. Select the **View Orientation** button on the *Heads-up View* toolbar by clicking once with the left-mouse-button.

2. Select the **Isometric** icon in the *View Orientation* pull-down menu.

- ❖ Notice the other view-related commands that are available under the pull-down menu.

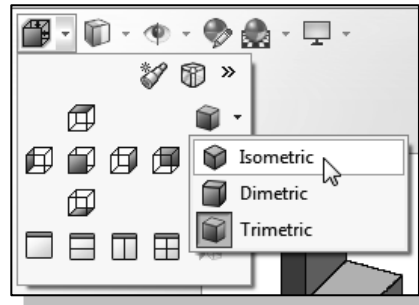

Rotation of the 3D Model – Rotate View

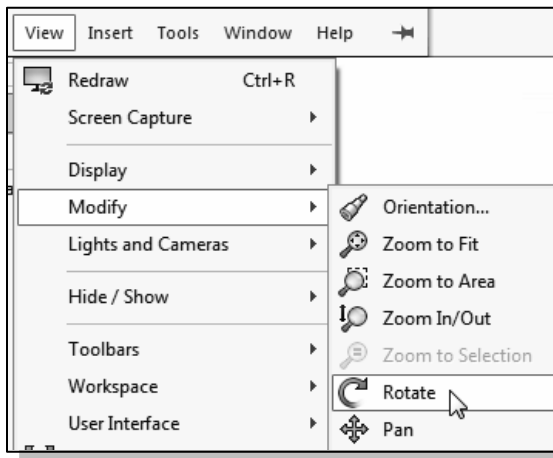

The Rotate View command allows us to rotate a part or assembly in the graphics window. Rotation can be around the center mark, free in all directions, or around a selected entity (vertex, edge, or face) on the model.

1. Move the cursor over the SOLIDWORKS logo to display the pull-down menus. Select **View** → **Modify** → **Rotate** from the pull-down menu as shown.

2. Move the cursor inside the graphics area. Press down the left-mouse-button and drag in an arbitrary direction; the Rotate View command allows us to freely rotate the solid model.

- The model will rotate about an axis normal to the direction of cursor movement. For example, drag the cursor horizontally across the screen and the model will rotate about a vertical axis.
3. Press the [**Esc**] key once to exit the Rotate View command.

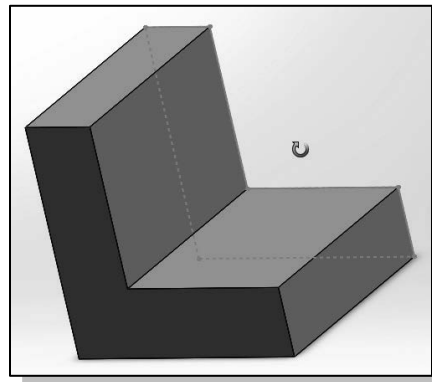

4. Select the **Isometric** icon in the *View Orientation* pull-down menu (see steps 1 and 2 in the previous section) to reset the display to the isometric view.
5. Execute the **Rotate View** option from the *View* pull-down menu (see step 1).

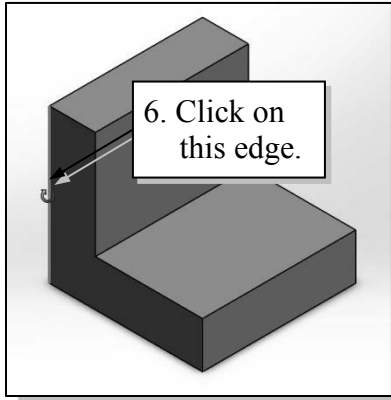

6. Move the cursor over the left edge of the solid model as shown. When the edge is highlighted, click the **left-mouse-button** once to select the edge.

7. Press down the left-mouse-button and drag. The model will rotate about this edge.

8. Left-click in the graphics area, outside the model, to unselect the edge.

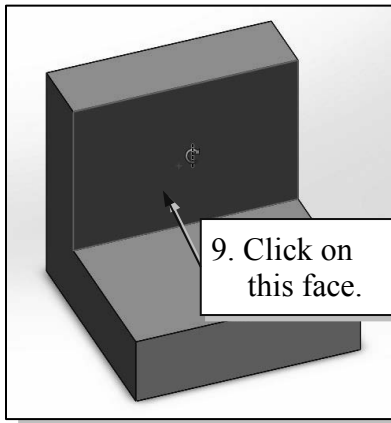

9. Move the cursor over the upper front face of the solid model as shown. When the face is highlighted, click the **left-mouse-button** once to select the face.

10. Press down the left-mouse-button and drag. The model will rotate about the direction normal to this face.

11. Left-click in the graphics area, outside the model, to unselect the face.

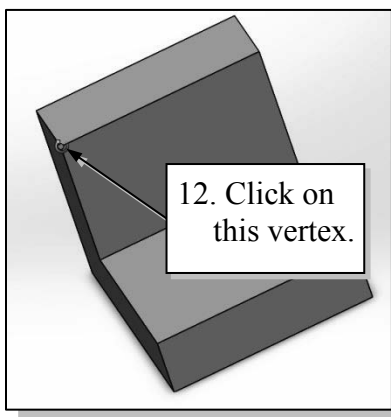

12. Move the cursor over the upper front vertex as shown. When the vertex is highlighted, click the left-mouse-button once to select the vertex.

13. Press down the left-mouse-button and drag. The model will rotate about the vertex.

14. Left-click in the graphics area, outside the model, to unselect the vertex.

15. Press the [**Esc**] key once to exit the **Rotate View** command.

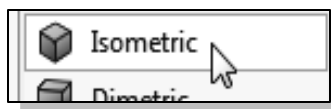

16. **On your own**, reset the display to the isometric view.

Rotation and Panning – Arrow Keys

SOLIDWORKS allows us to easily rotate a part or assembly in the graphics window using the arrow keys on the keyboard.

- Use the **arrow** keys to rotate the view horizontally or vertically. The **left-right** arrow keys rotate the model about a vertical axis. The **up-down** keys rotate the model about a horizontal axis.
- Hold down the **Alt** key and use the **left-right** arrow keys to rotate the model about an axis normal to the screen, i.e., to rotate clockwise and counterclockwise.

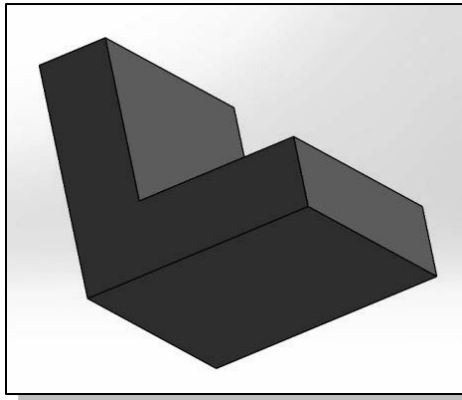

1. Hit the **left arrow** key. The model view rotates by a pre-determined increment. The default increment is 15° . (This increment can be set in the *Options* dialog box.) On your own use the **left-right** and **up-down** arrow keys to rotate the view.
2. Hold down the [**Alt**] key and hit the **left arrow** key. The model view rotates in the clockwise direction. On your own use the **left-right** and **up-down** arrow keys, and the **Alt** key plus the **left-right** arrow keys, to rotate the view.
3. Reset the display to the **Isometric** view.
 - Hold down the [**Shift**] key and use the **left-right** and **up-down** arrow keys to rotate the model in 90° increments.
4. Hold down the [**Shift**] key and hit the **right arrow** key. The view will rotate by 90° . On your own use the [**Shift**] key plus the **left-right** arrow keys to rotate the view.
5. Select the **Front** icon in the *View Orientation* pull-down menu as shown to display the **Front** view of the model.

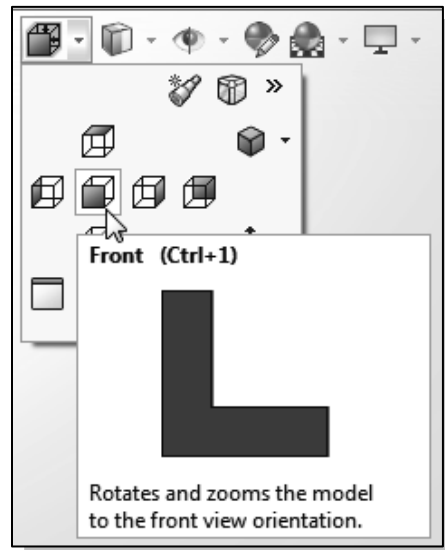

6. Hold down the [**Shift**] key and hit the **left arrow** key. The view rotates to the **Right side** view.
7. Hold down the [**Shift**] key and hit the **down arrow** key. The view rotates to the **Top** view.

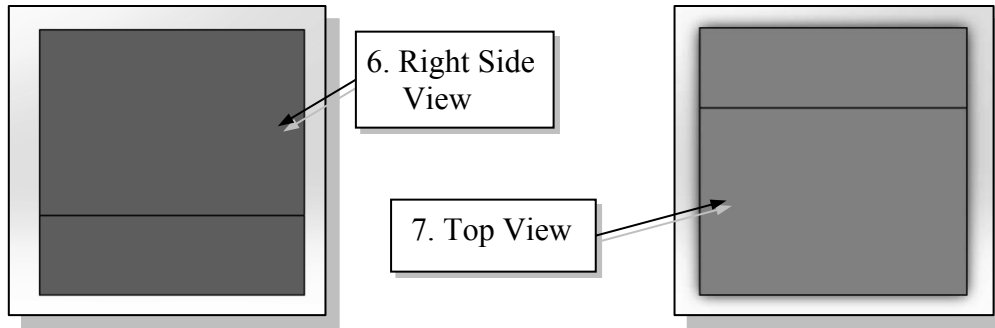

8. Reset the display to the **Isometric** view.
 - Hold down the [**Ctrl**] key and use the **left-right** and **up-down** arrow keys to pan the model in increments.
9. Hold down the [**Ctrl**] key and hit the **left arrow** key. The view pans, moving the model toward the left side of the screen. On your own use [**Ctrl**] key plus the **left-right** and **up-down** arrow keys to pan the view.

Viewing – Quick Keys

We can also use the function keys on the keyboard and the mouse to access the *Viewing* functions.

❖ Panning

(1) Hold Ctrl key, press and drag the mouse wheel

Hold the [**Ctrl**] function key down, and press and drag with the mouse wheel to pan the display. This allows you to reposition the display while maintaining the same scale factor of the display.

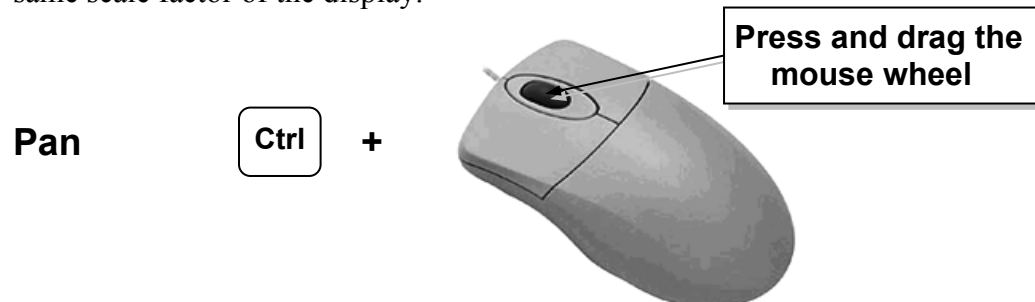

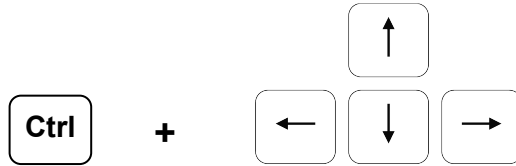
(2) Hold Ctrl key, use arrow keys**❖ Zooming****(1) Hold Shift key, press and drag the mouse wheel**

Hold the [**Shift**] function key down and press and drag with the mouse wheel to zoom the display. Moving downward will reduce the scale of the display, making the entities display smaller on the screen. Moving upward will magnify the scale of the display.

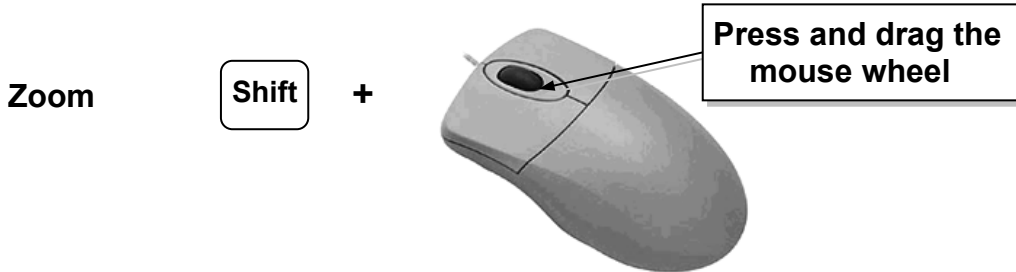
**(2) Turning the mouse wheel**

Turning the mouse wheel can also adjust the scale of the display. Turning forward will reduce the scale of the display, making the entities display smaller on the screen. Turning backward will magnify the scale of the display.

- Turning the mouse wheel allows zooming to the position of the cursor.
- If the cursor is outside the graphics area, the wheel will allow zooming to the center of the graphics area.

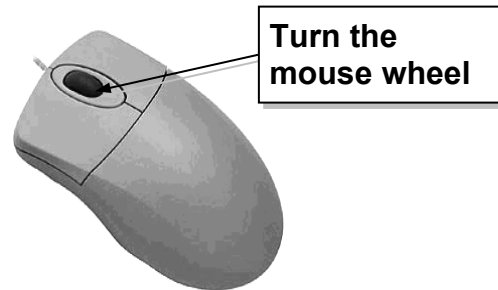
**(3) Z key or Shift + Z key**

Pressing the [**Z**] key on the keyboard will zoom out. Holding the [**Shift**] function key and pressing the [**Z**] key will zoom in.

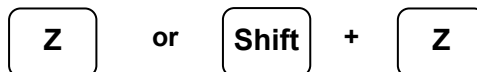

❖ **3D Rotation**

(1) Press and drag the mouse wheel

Press and drag with the mouse wheel to rotate the display.

Rotation

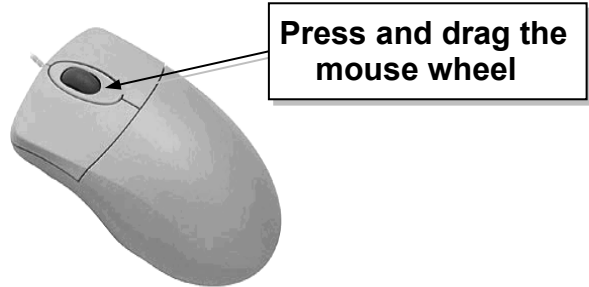

(2) Use arrow keys

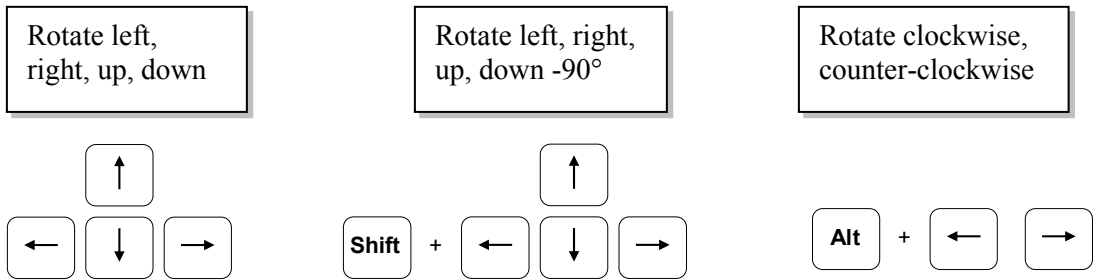

Viewing Tools – Heads-up View Toolbar

The *Heads-up View* toolbar is a transparent toolbar which appears in each viewport and provides easy access to commonly used tools for manipulating the view. The default toolbar is described below.

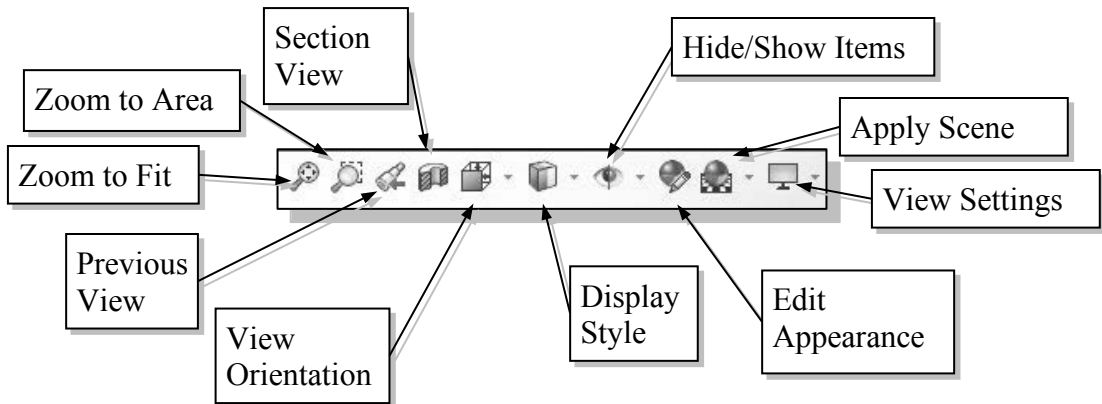

Zoom to Fit – Adjusts the view so that all items on the screen fit inside the graphics window.

Zoom to Area – Use the cursor to define a region for the view; the defined region is zoomed to fill the graphics window.

Previous View – Returns to the previous view.

Section View – Displays a cutaway of a part or assembly using one or more section planes.

View Orientation – This allows you to change the current view orientation or number of viewports.

Display Style – This can be used to change the display style (shaded, wireframe, etc.) for the active view.

Hide/Show Items – The pull-down menu is used to control the visibility of items (axes, sketches, relations, etc.) in the graphics area.

Edit Appearance – Edits the appearance of entities (e.g., parts, faces, features) in the model.

Apply Scene – Cycles through or applies a specific scene.

View Settings – Allows you to toggle various view settings (e.g., shadows, perspective).

View Orientation

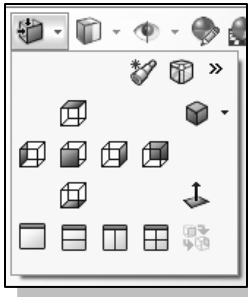

Click on the **View Orientation** icon on the *Heads-up View* toolbar to reveal the view orientation and number of viewports options.

Standard view orientation options – **Front, Back, Left, Right, Top, Bottom, Isometric, Trimetric, or Dimetric** – icons can be selected to display the corresponding standard view. In the figure to the left, the *Isometric* view is selected.



Normal to – In a part or assembly, zooms and rotates the model to display the selected plane or face. You can select the element either before or after clicking the **Normal to** icon.



The icons across the bottom of the pull-down menu allow you to display a single viewport (the default) or multiple viewports.



The **View Selector** provides an in-context method to select standard and non-standard views.



The **Add View** option allows you to add a custom view to the *Orientation* menu.

Display Style

Click on the **Display Style** icon on the *Heads-up View* toolbar to reveal the display style options.

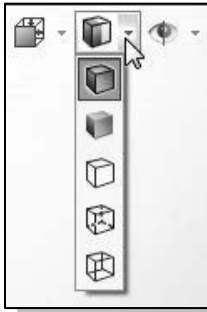

Shaded with Edges – Allows the display of a shaded view of a 3D model with its edges.

Shaded – Allows the display of a shaded view of a 3D model.

Hidden Lines Removed – Allows the display of the 3D objects using the basic wireframe representation scheme. Only those edges which are visible in the current view are displayed.

Hidden Lines Visible – Allows the display of the 3D objects using the basic wireframe representation scheme in which all the edges of the model are displayed, but edges that are hidden in the current view are displayed as dashed lines (or in a different color).

Wireframe – Allows the display of the 3D objects using the basic wireframe representation scheme in which all the edges of the model are displayed.

Orthographic vs. Perspective

Besides the basic display modes, we can also choose orthographic view or perspective view of the display. Clicking on the **View Settings** icon on the *Heads-up View* toolbar will reveal the **Perspective** icon. Clicking on the **Perspective** icon toggles the perspective view *ON* and *OFF*.

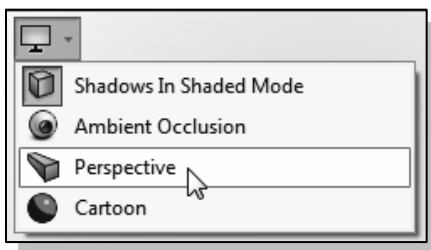

- On your own, use the different options described in the above sections to familiarize yourself with the 3D viewing/display commands. Reset the display to the standard **isometric view** before continuing to the next section.

Sketch Plane

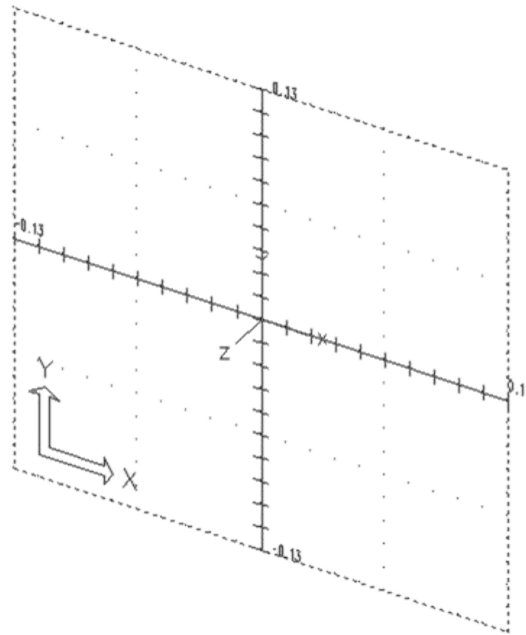

Design modeling software is becoming more powerful and user friendly, yet the system still does only what the user tells it to do. When using a geometric modeler, we therefore need to have a good understanding of what its inherent limitations are. We should also have a good understanding of what we want to do and what to expect, as the results are based on what is available.

In most 3D geometric modelers, 3D objects are located and defined in what is usually called **world space** or **global space**. Although a number of different coordinate systems can be used to create and manipulate objects in a 3D modeling system, the objects are typically defined and stored using the world space. The world space is usually a **3D Cartesian coordinate system** that the user cannot change or manipulate.

In most engineering designs, models can be very complex, and it would be tedious and confusing if only the world coordinate system were available. Practical 3D modeling systems allow the user to define **Local Coordinate Systems** relative to the world coordinate system. Once a local coordinate system is defined, we can then create geometry in terms of this more convenient system.

Although objects are created and stored in 3D space coordinates, most of the geometry entities can be referenced using 2D Cartesian coordinate systems. Typical input devices such as a mouse or digitizers are two-dimensional by nature; the movement of the input device is interpreted by the system in a planar sense. The same limitation is true of common output devices, such as screen displays and plotters. The modeling software performs a series of three-dimensional to two-dimensional transformations to correctly project 3D objects onto a 2D picture plane.

The SOLIDWORKS *sketch plane* is a special construction tool that enables the planar nature of 2D input devices to be directly mapped into the 3D coordinate system. The *sketch plane* is a local coordinate system that can be aligned to the world coordinate system, an existing face of a part, or a reference plane. By default, the *sketch plane* is aligned to the world coordinate system.

Think of a sketch plane as the surface on which we can sketch the 2D profiles of the parts. It is similar to a piece of paper, a white board, or a chalkboard that can be attached to any planar surface. The first profile we create is usually drawn on a sketch plane attached to a coordinate system such as the **Front (XY)**, **Top (XZ)**, and **Right (YZ)** sketch planes. Subsequent profiles can then be drawn on sketch planes that are defined on **planar faces of a part**, **work planes attached to part geometry**, or **sketch planes attached to a coordinate system**. The model we have created so far used the SOLIDWORKS **Front Plane**, which is aligned to the XY plane of the world coordinate system.



1. Select the **Sketch** button at the top of the *Sketch* toolbar to create a new sketch.

2. In the *Edit Sketch PropertyManager*, the message “*Select: 1) a plane, a planar face, or an edge on which to create a sketch for the entity*” is displayed. SOLIDWORKS expects us to identify a planar surface where the 2D sketch of the next feature is to be created. Move the graphics cursor on the 3D part and notice that SOLIDWORKS will automatically highlight feasible planes and surfaces as the cursor is on top of the different surfaces. Pick the top horizontal face of the 3D solid object.

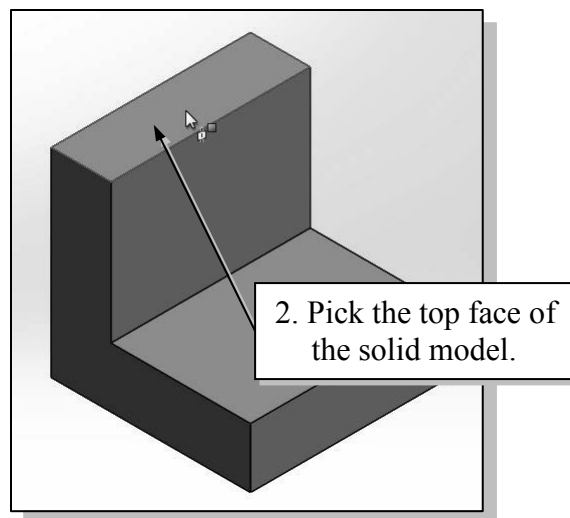

- Note that the sketch plane is aligned to the selected face. SOLIDWORKS automatically establishes a local coordinate system, and records its location with respect to the part on which it was created.

Step 4-1: Adding an Extruded Boss Feature

Next, we will create and profile another sketch, a rectangle, which will be used to create another extrusion feature that will be added to the existing solid object.



1. Select the **Line** command by clicking once with the **left-mouse-button** on the icon in the *Sketch* toolbar.

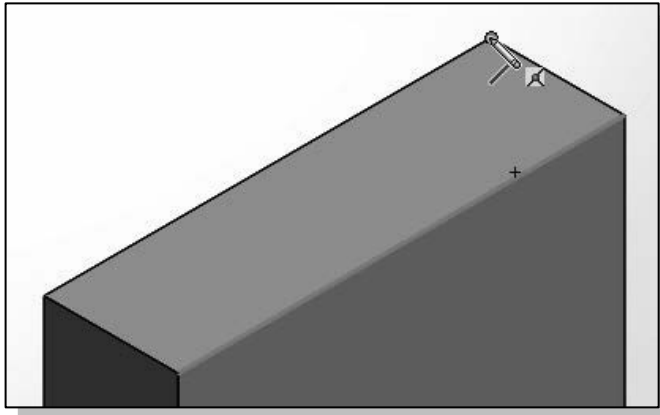

2. Move the cursor over the rear top vertex of the model. When the **Coincident** relation symbol appears as shown, click once with the **left-mouse-button**. This will start the first line, constraining its endpoint to be coincident with the vertex.

3. Create a sketch with segments perpendicular/parallel to the existing edges of the solid model as shown below. **Close the sketch by ending at Point 1.** **NOTE:** Use the **Pan** and **Zoom** options discussed earlier to control the view as needed.

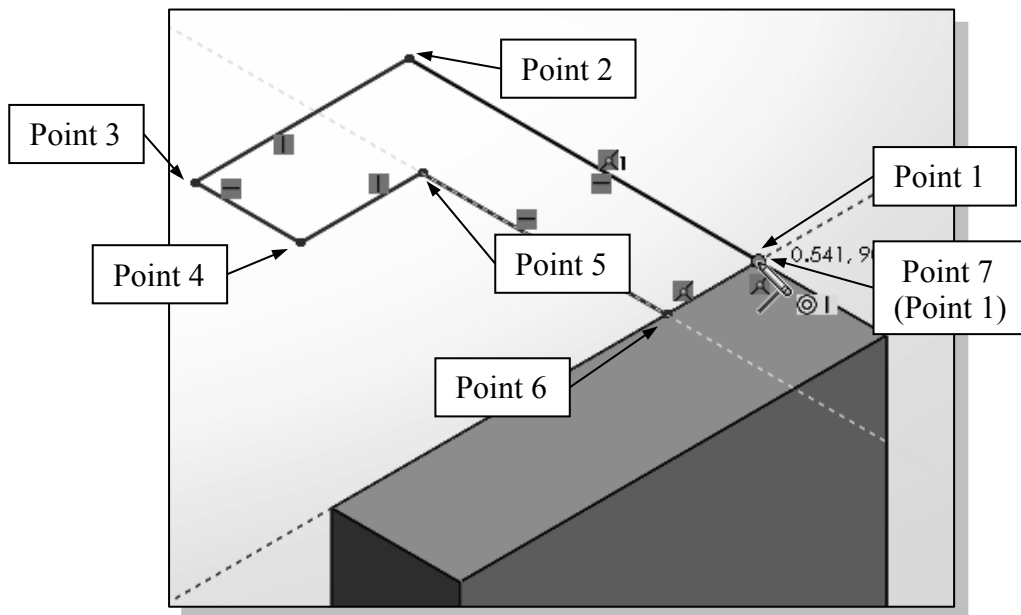

4. Click the **OK** icon (green check mark) in the *PropertyManager* twice, or hit the **[Esc]** key once, to end the **Sketch Line** command.

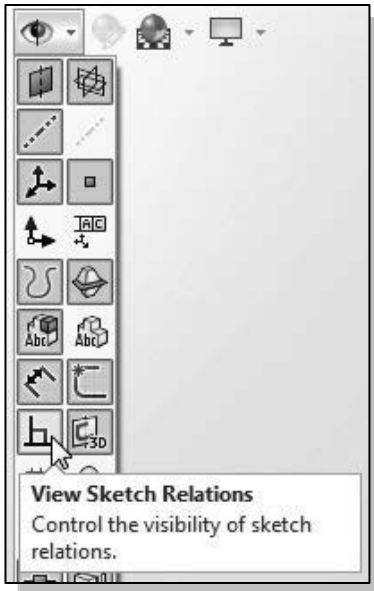

- We will hide the *Sketch Relation* icons in the sketch. The visibility of these and other items is controlled using the *Hide/Show Items* option on the *Heads-up View* toolbar.
- 5. Click on the **Hide/Show Items** icon on the *Heads-up View* toolbar to reveal the pull-down menu.
- 6. Click on the **View Sketch Relations** icon on the pull-down menu to toggle the sketch relation icon visibility *OFF*.
- 7. Click away from the pull-down menu to accept the settings.



- 8. Select the **Smart Dimension** command in the *Sketch* toolbar. The **Smart Dimension** command allows us to quickly create and modify dimensions. Left-click once on the icon to activate the **Smart Dimension** command.
- 9. The message “*Select one or two edges/vertices and then a text location*” is displayed in the *Status Bar* area, at the bottom of the SOLIDWORKS window. Create the four dimensions to describe the size of the sketch as shown in the figure, entering the values shown (**2.5**, **2.5**, **0.75** and **0.75**).

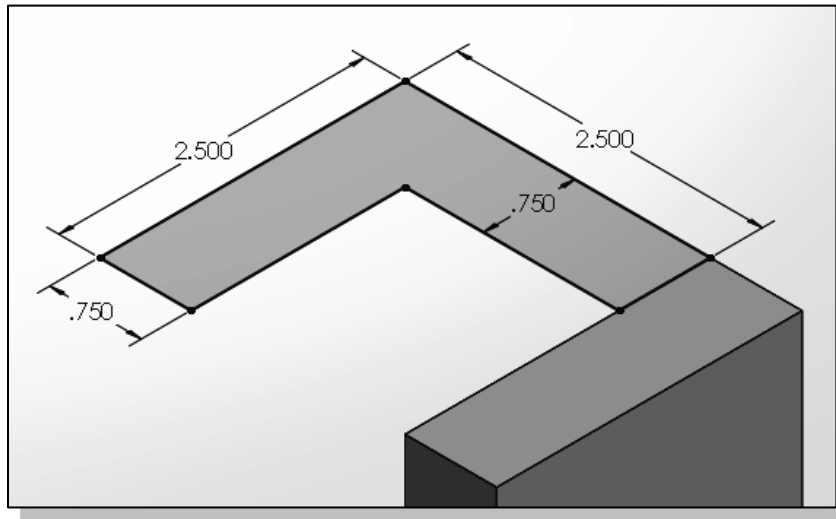

- 10. Click the **OK** icon in the *PropertyManager* as shown, or hit the [**Esc**] key once, to end the **Smart Dimension** command.

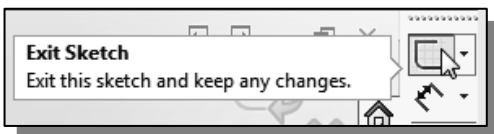

- 11. Click once with the **left-mouse-button** on the **Sketch** icon on the *Sketch* toolbar to exit the sketch.



12. In the *Features* toolbar (located at the left of the window), select the **Extruded Boss/Base** command by clicking once with the left-mouse-button on the icon.

13. In the *Boss Extrude PropertyManager* panel, enter **2.5** as the extrusion distance. Notice that the sketch region is automatically selected as the extrusion profile. (Note: If the *Selected Contours* window is highlighted, left-click inside the contour to select the area to be extruded.)

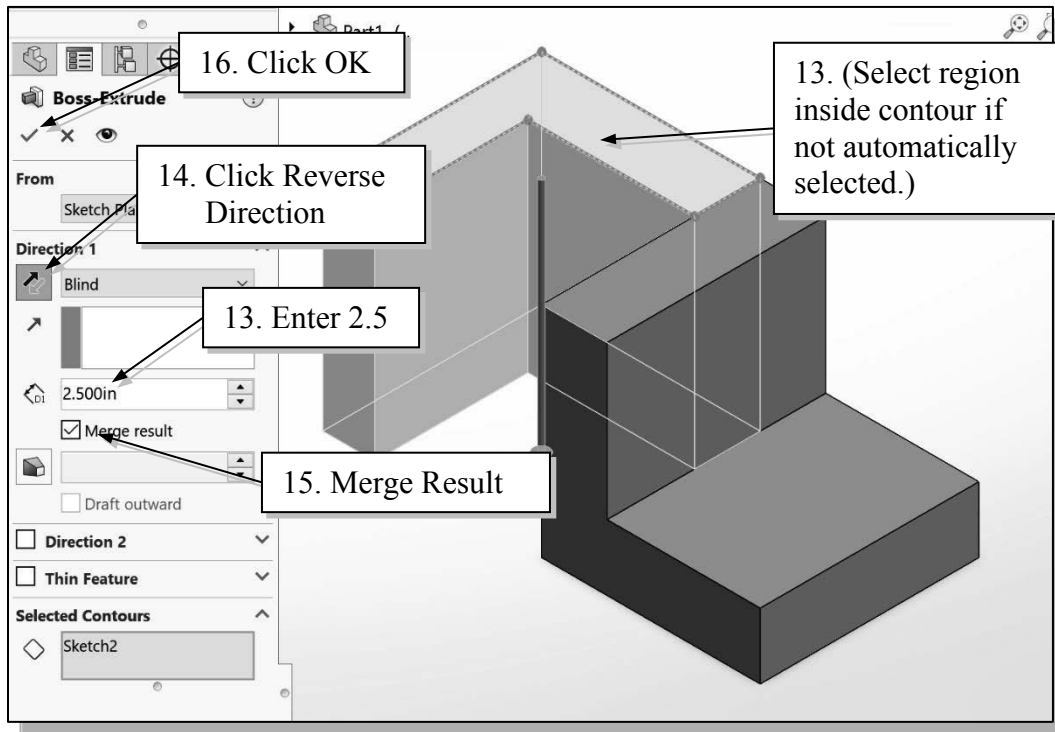

14. Click the **Reverse Direction** button in the *PropertyManager* if necessary. The extrude preview should appear as shown above.

15. Make sure the **Merge Result** option is selected (checkbox is checked).

- ❖ With the **Merge Result** option selected, the resultant body is merged into the existing body (if possible). If the **Merge Result** option is not selected, the *Extruded Boss/Base* feature creates a distinct solid body.

16. Click on the **OK** button to proceed with creating the extruded feature.

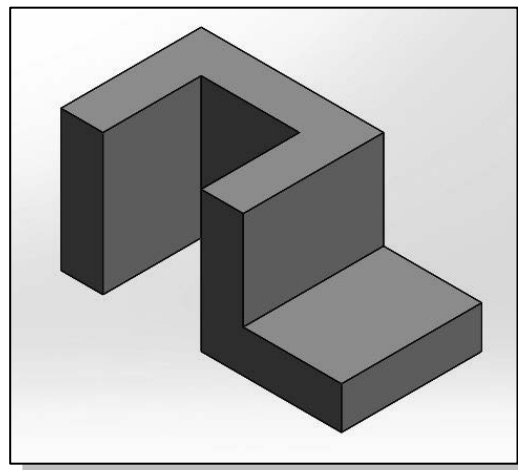

Step 4-2: Adding an Extruded Cut Feature

Next, we will create and profile a circle, which will be used to create a **cut** feature that will be added to the existing solid object.

1. Click in the graphics area, away from the model, to ensure no items are selected.



2. Select the **Sketch** button at the top of the *Sketch* toolbar to create a new sketch.

3. In the *Edit Sketch PropertyManager*, the message “Select: 1) a plane, a planar face, or an edge on which to create a sketch for the entity” is displayed. SOLIDWORKS expects us to identify a planar surface where the 2D sketch of the next feature is to be created. Move the graphics cursor on the 3D part and notice that SOLIDWORKS will automatically highlight feasible planes and surfaces as the cursor is on top of the different surfaces. **Pick the horizontal face of the 3D solid object.**

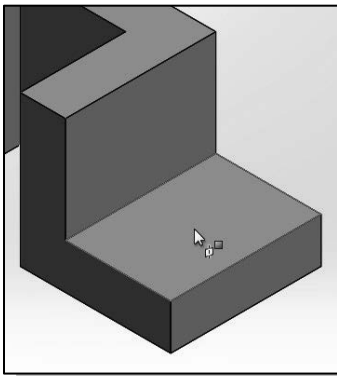

- Note that the sketch plane is aligned to the selected face.

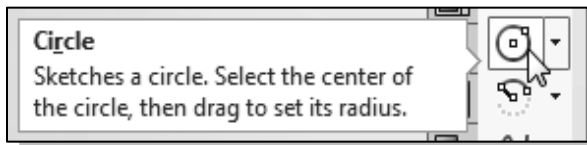

4. Select the **Circle** command by clicking once with the **left-mouse-button** on the icon in the *Sketch* toolbar.

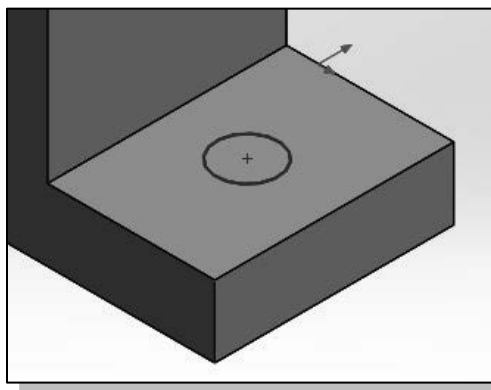

5. Create a circle of arbitrary size on the top face of the solid model as shown. Click once with the left-mouse-button to select the center of the circle, move and click again to set the radius. Press the [**Esc**] key once to end the **Circle** command.

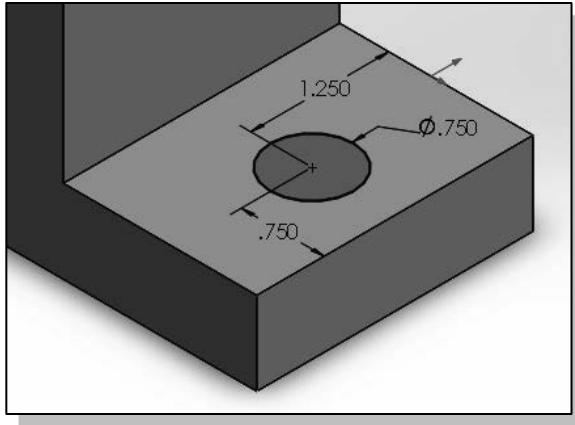

- On your own, create and modify the dimensions of the sketch as shown in the figure. **NOTE:** Select the center of the circle, then the appropriate edge to apply the linear dimensions. Select any point on the circle to apply the diameter dimension.

- Click the **OK** icon in the *PropertyManager*, or hit the [**Esc**] key once, to end the Smart Dimension command.

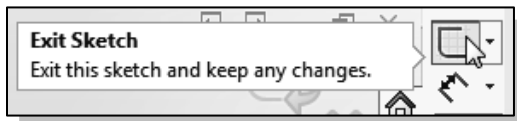

- Click once with the **left-mouse-button** on the **Sketch** icon on the *Sketch* toolbar to exit the sketch.

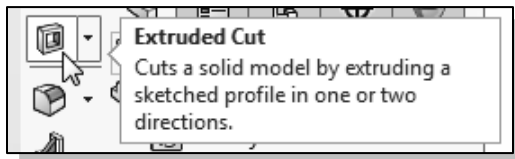

- In the *Features* toolbar (located at the left of the window), select the **Extruded Cut** command by clicking once with the left-mouse-button on the icon. The *Extrude PropertyManager* is displayed in the left panel. Notice that the sketch region (the circle) is automatically selected as the extrusion profile.

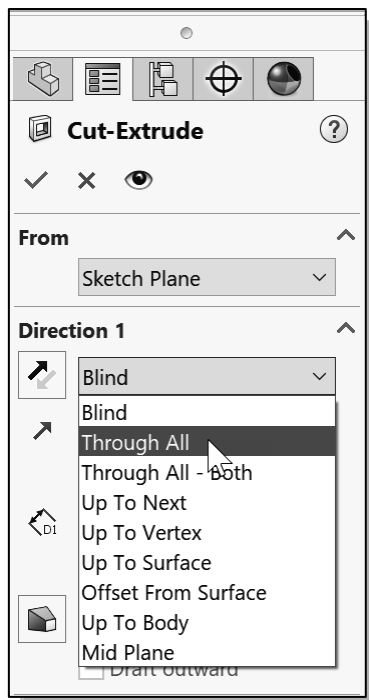

- In the *Cut-Extrude PropertyManager* panel, click the arrow to reveal the pull-down options for the *End Condition* (the default end condition is 'Blind'), and select **Through All** as shown.

- Click the **OK** button (green check mark) in the *Cut-Extrude PropertyManager* panel.

- Click in the graphics area, away from the model, to ensure no items are selected.

- Press the **F** key on the keyboard to fit the model to the screen.

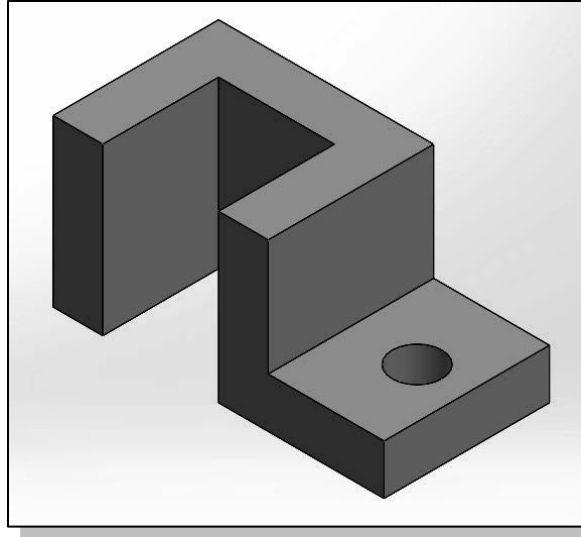

Save the Part File

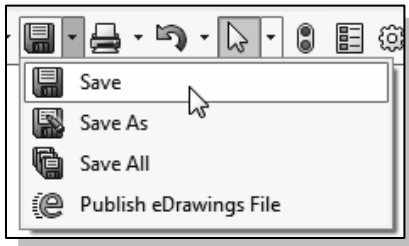

1. Select **Save** in the *Menu Bar* pull-down menu, or you can also use the “**Ctrl-S**” combination (hold down the “Ctrl” key and hit the “S” key once) to save the part.

2. In the pop-up window, select the directory to store the model in and enter **Adjuster** as the name of the file.

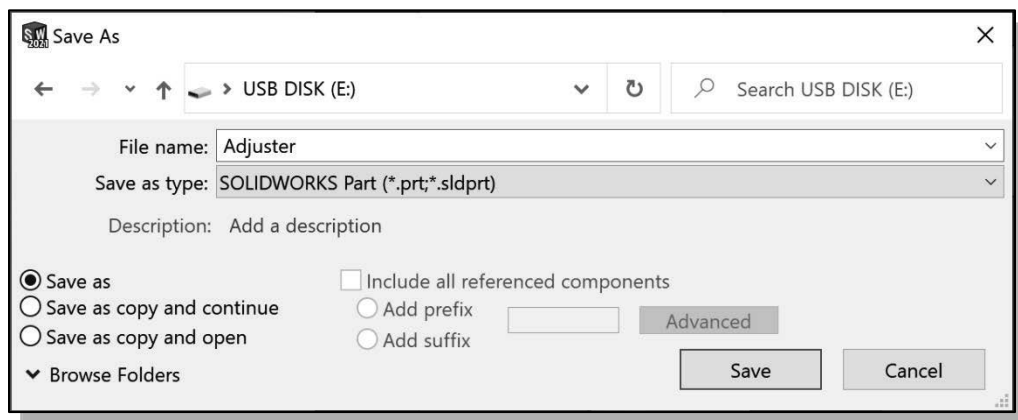

3. Click on the **Save** button to save the file.

- ❖ You should form a habit of saving your work periodically, just in case something might go wrong while you are working on it. In general, one should save one’s work at an interval of every 15 to 20 minutes. One should also save before making any major modifications to the model.

Questions:

1. What is the first thing we should set up in SOLIDWORKS when creating a new model?
2. What is the main difference between a rough sketch and a *profile*?
3. List two of the geometric relation symbols used by SOLIDWORKS.
4. What was the first feature we created in this lesson?
5. Identify the following commands:

(a)



(b)

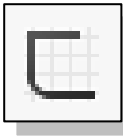

(c)

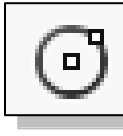

(d)

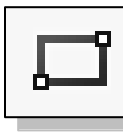

Exercises: (All dimensions are in inches.)

1. Inclined Support (Thickness: .5)

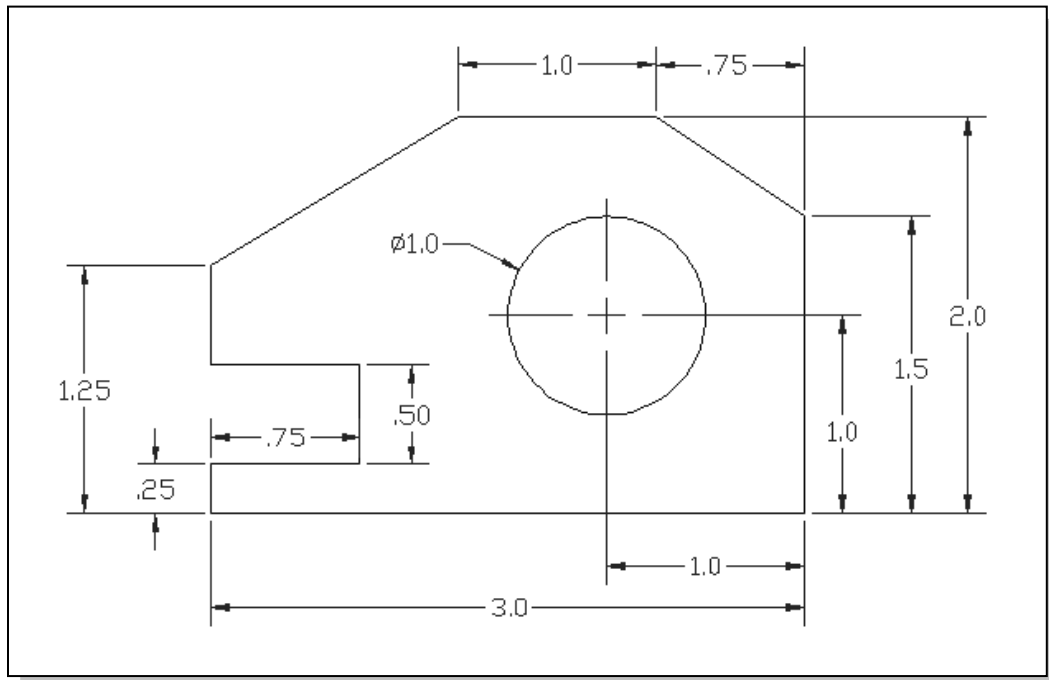

2. Spacer Plate (Thickness: .125)

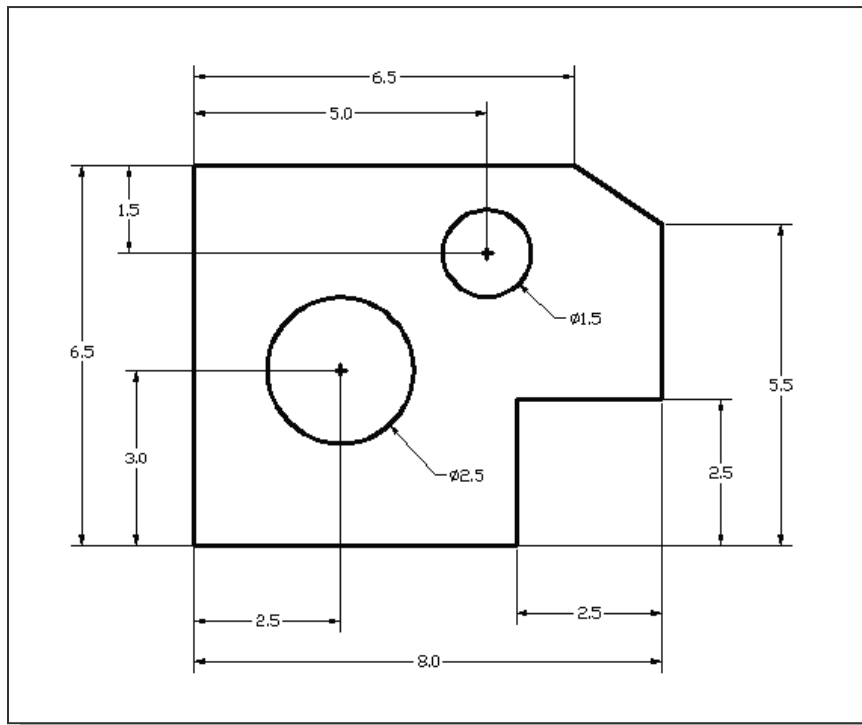

3. Positioning Stop

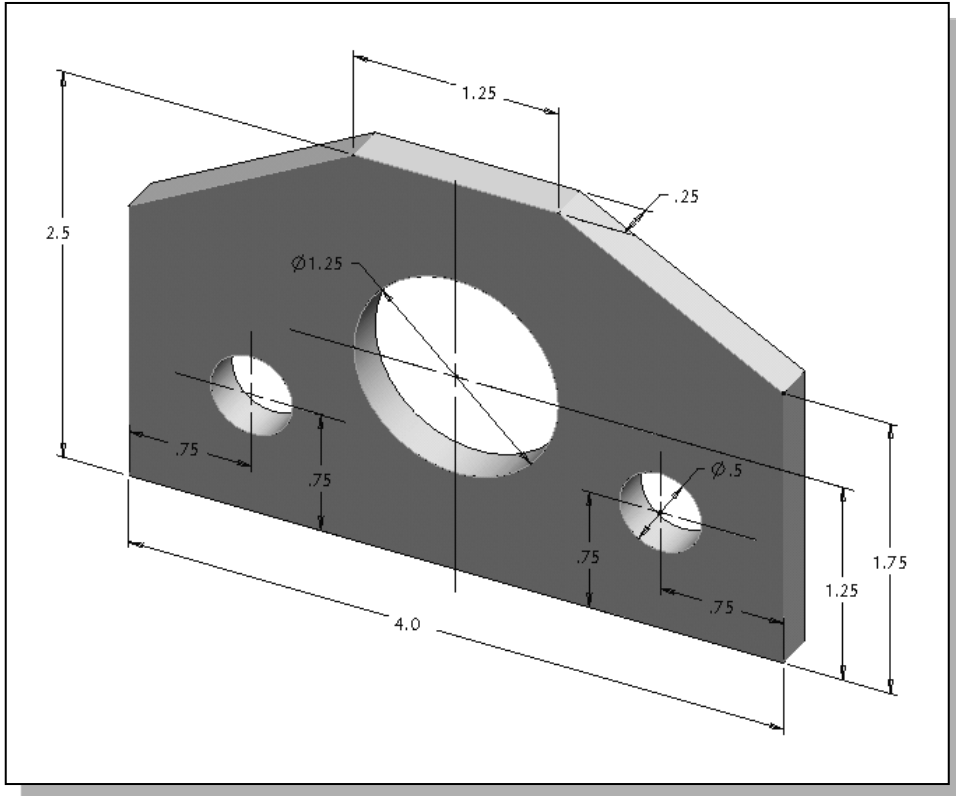

4. Guide Block

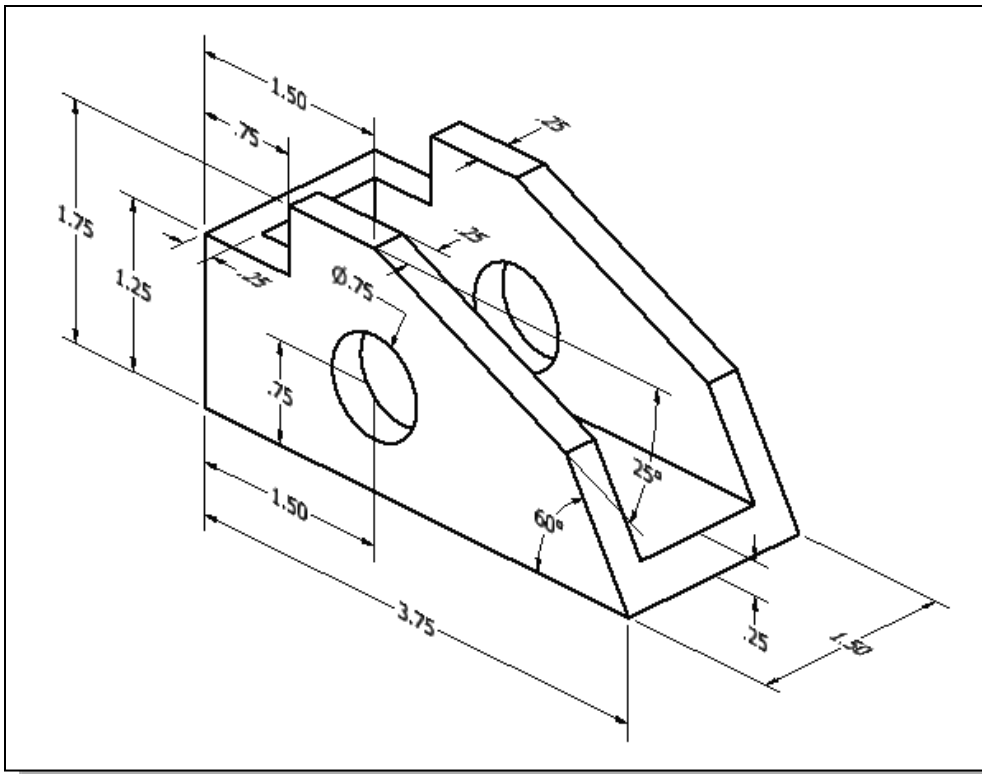

NOTES: