

AutoCAD[®] 2022 INSTRUCTOR

James A. Leach
Shawna Lockhart



Better Textbooks. Lower Prices.
www.SDCpublications.com



ACCESS CODE
UNIQUE CODE INSIDE

Visit the following websites to learn more about this book:



[amazon.com](https://www.amazon.com)

[Google books](https://books.google.com)

[BARNES & NOBLE](https://www.barnesandnoble.com)

CHAPTER

1

Getting Started

Chapter Objectives

After completing this chapter you should:

1. understand how the X, Y, Z coordinate system is used to define the location of drawing elements in digital format in a CAD drawing file;
2. understand why you should create drawings full size in the actual units with CAD;
3. be able to start AutoCAD to begin drawing;
4. recognize the areas of the AutoCAD Drawing Editor and know the function of each;
5. be able to use the many methods of entering commands;
6. be able to turn on and off the *Snap*, *Grid*, *Ortho*, *Polar*, and *Dynamic Input* drawing aids;
7. know how to customize the AutoCAD for Windows screen to your preferences.

CONCEPTS

Coordinate Systems

Any location in a drawing, such as the endpoint of a line, can be described in X, Y, and Z coordinate values (Cartesian coordinates). If a line is drawn on a sheet of paper, for example, its endpoints can be charted by giving the distance over and up from the lower-left corner of the sheet (Fig. 1-1).

These distances, or values, can be expressed as X and Y coordinates; X is the horizontal distance from the lower-left corner (origin) and Y is the vertical distance from that origin. In a three-dimensional coordinate system, the third dimension, Z, is measured from the origin in a direction perpendicular to the plane defined by X and Y.

Two-dimensional (2D) and three-dimensional (3D) CAD systems use coordinate values to define the location of drawing elements such as lines and circles (called objects in AutoCAD).

In a 2D drawing, a line is defined by the X and Y coordinate values for its two endpoints (Fig. 1-2).

In a 3D drawing, a line can be created and defined by specifying X, Y, and Z coordinate values (Fig. 1-3). Coordinate values are always expressed by the X value first separated by a comma, then Y, then Z.

FIGURE 1-1

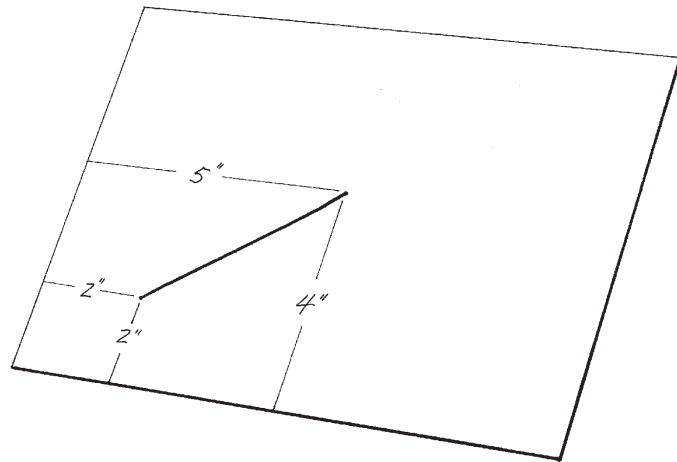

FIGURE 1-2

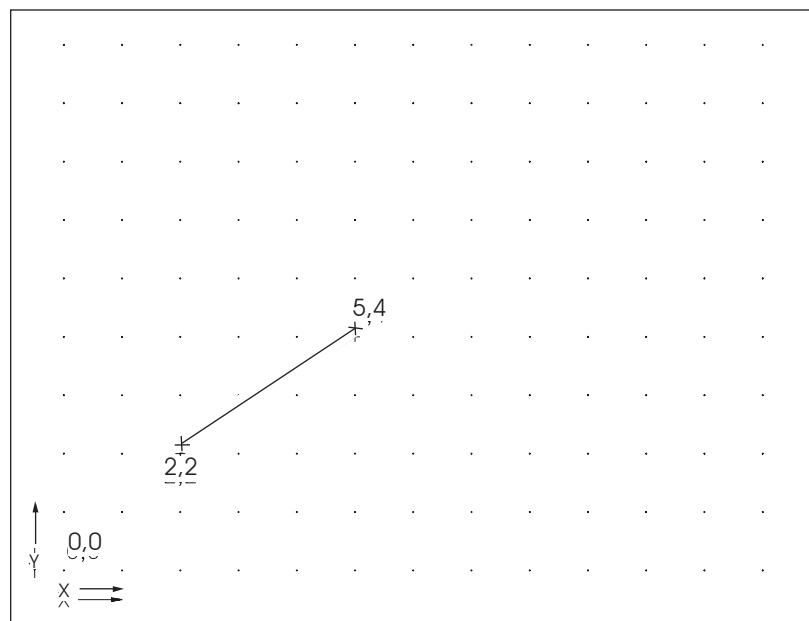
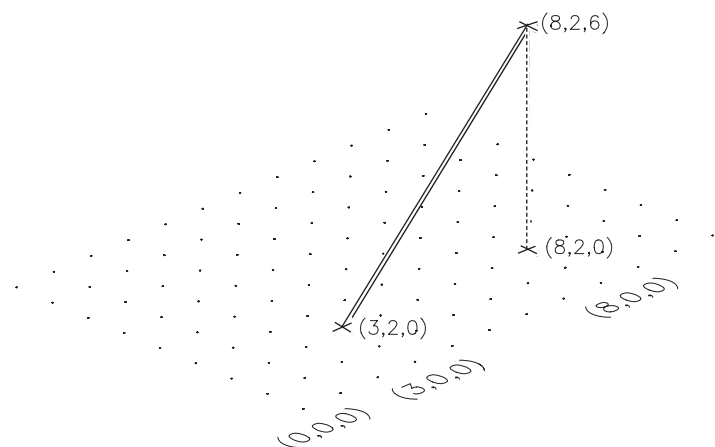

FIGURE 1-3



The CAD Database

A CAD (Computer-Aided Design) file, which is the electronically stored version of the drawing, keeps data in binary digital form. These digits describe coordinate values for all of the endpoints, center points, radii, vertices, etc. for all the objects composing the drawing, along with another code that describes the kinds of objects (line, circle, arc, ellipse, etc.). Figure 1-4 shows part of an AutoCAD DXF (Drawing Interchange Format) file giving numeric data defining lines and other objects. Knowing that a CAD system stores drawings by keeping coordinate data helps you understand the input that is required to create objects and how to translate the meaning of prompts on the screen.

FIGURE 1-4

```

LINE
 8
0
 62
 8
 10
15.0
 20
8.105789
 30
0.0
 11
15.644291
 21
 8.75
 31
0.0
 0
LINE
 8
0
 62
 8
 18

```

Angles in AutoCAD

Angles in AutoCAD are measured in a counterclockwise direction. Angle 0 is positioned in a positive X direction, that is, horizontally from left to right. Therefore, 90 degrees is in a positive Y direction, or straight up; 180 degrees is in a negative X direction, or to the left; and 270 degrees is in a negative Y direction, or straight down (Fig. 1-5).

The position and direction of measuring angles in AutoCAD can be changed; however, the defaults listed here are used in most cases.

FIGURE 1-5

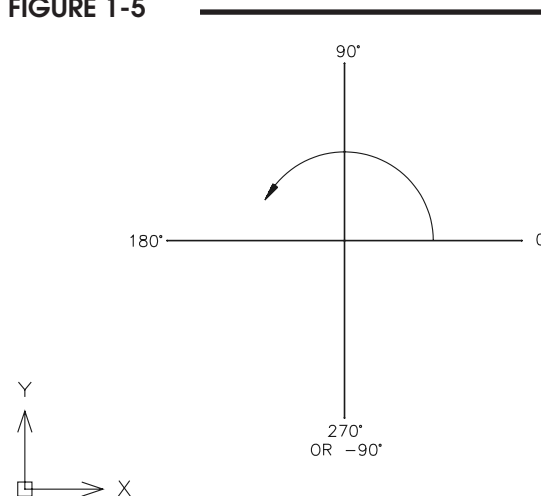

Draw True Size

When creating a drawing with pencil and paper tools, you must first determine a scale to use so the drawing will be proportional to the actual object and will fit on the sheet (Fig. 1-6). However, when creating a drawing on a CAD system, there is no fixed size drawing area. The number of drawing units that appear on the screen is variable and is assigned to fit the application.

The CAD drawing is not scaled until it is physically transferred to a fixed size sheet of paper by plotter or printer.

FIGURE 1-6

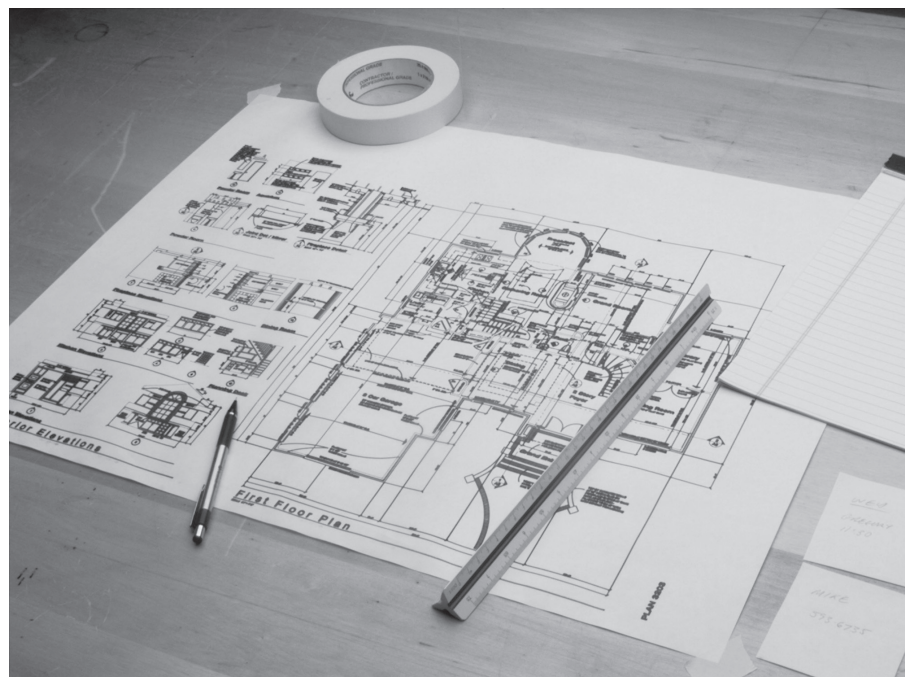



The rule for creating CAD drawings is that the drawing should be created true size using real-world units. The user specifies what units are to be used (architectural, engineering, etc.) and then specifies what size drawing area is needed (in X and Y values) to draw the necessary geometry (Fig. 1-7).

FIGURE 1-7

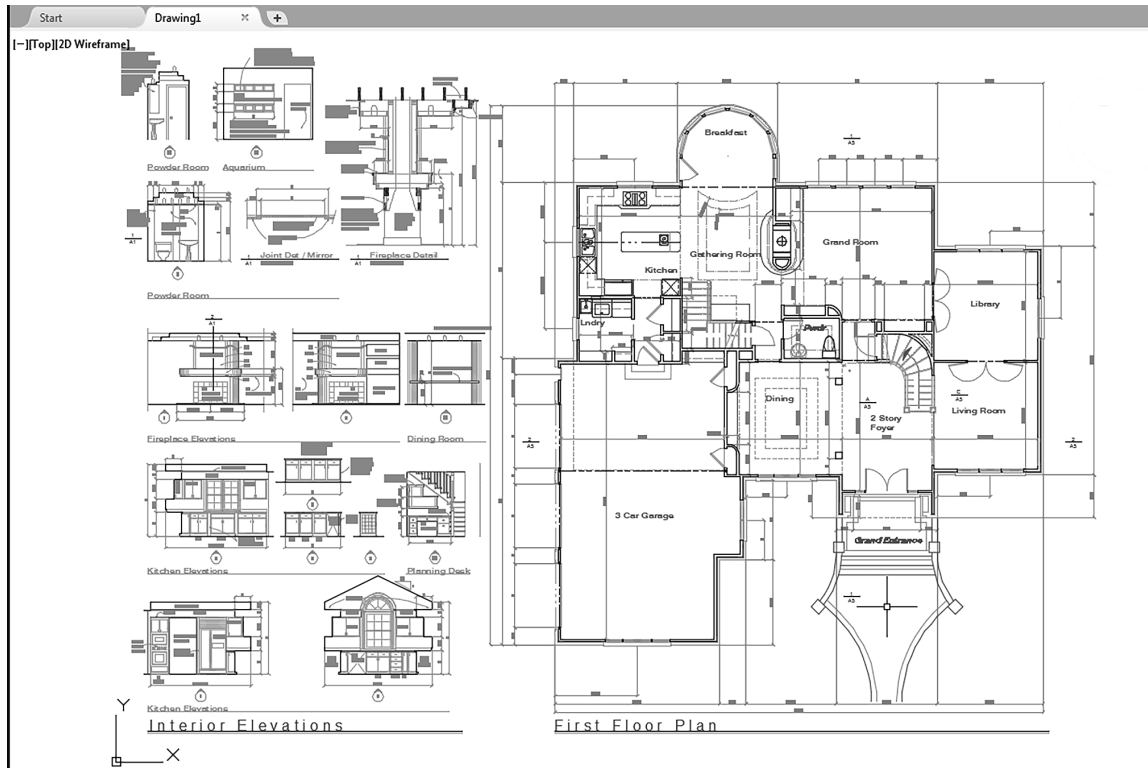

Whatever the specified size of the drawing area, it can be displayed on the screen in its entirety (Fig. 1-7) or as only a portion of the drawing area (Fig. 1-8).

FIGURE 1-8

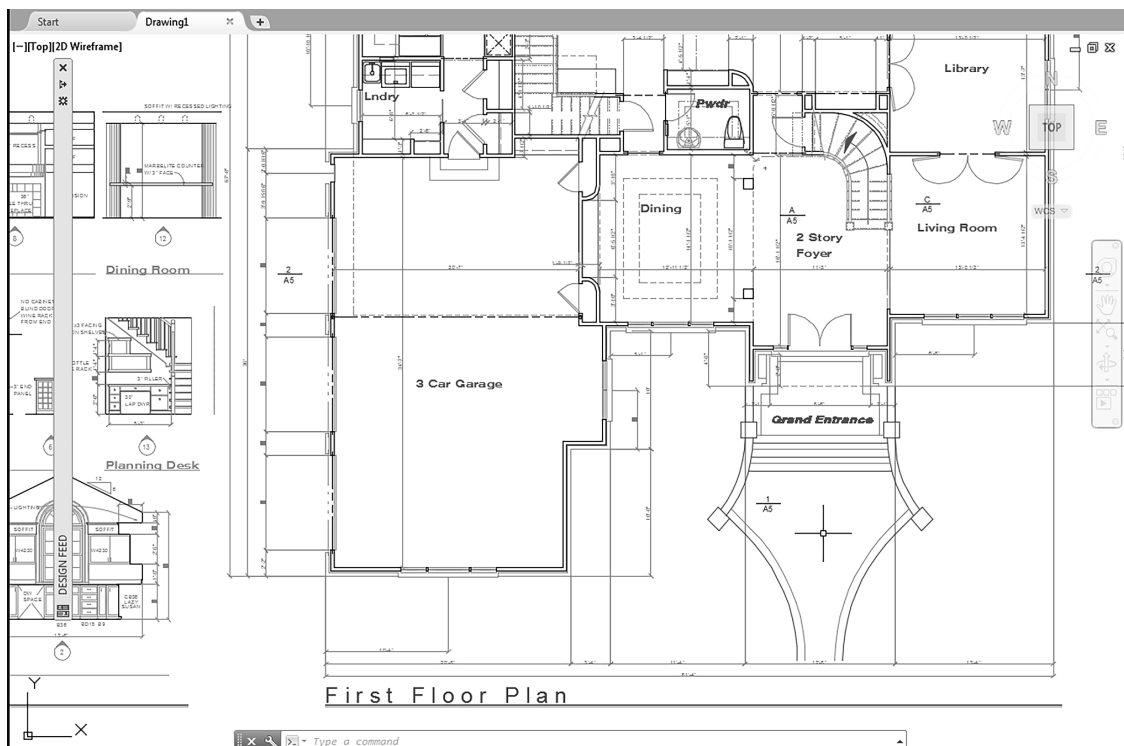

Plot to Scale

As long as a drawing exists as a CAD file or is visible on the screen, it is considered a virtual, full-sized object. Only when the CAD drawing is transferred to paper by a plotter or printer is it converted (usually reduced) to a size that will fit on a sheet. A CAD drawing can be automatically scaled to fit on the sheet regardless of sheet size; however, this action results in a plotted drawing that is not to an accepted scale (not to a regular proportion of the real object). Usually it is desirable to plot a drawing so that the resulting drawing is a proportion of the actual object size. The scale to enter as the plot scale (Fig. 1-9) is simply the proportion of the plotted drawing size to the actual object.

FIGURE 1-9

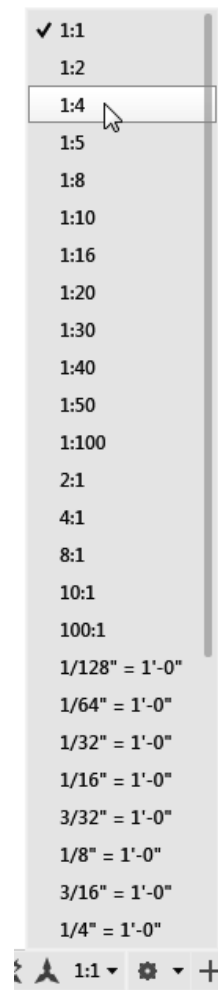

STARTING AutoCAD

Assuming that AutoCAD has been installed and configured properly for your system, you are ready to begin using AutoCAD.

To start AutoCAD 2022, locate the “AutoCAD 2022” shortcut icon on the desktop (Fig. 1-10). Double-clicking on the icon launches AutoCAD 2022.

If you cannot locate the AutoCAD 2022 shortcut icon on the desktop, select the “Windows” button and search for “AutoCAD 2022” in the Programs list (Fig. 1-11).

FIGURE 1-10



FIGURE 1-11

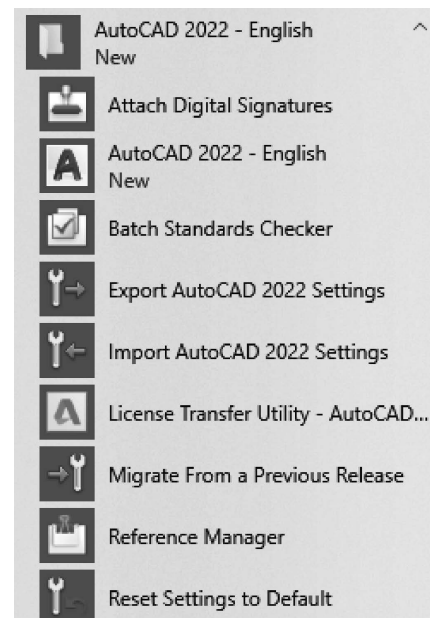

THE AutoCAD DRAWING EDITOR

When you start AutoCAD, you see the Start Screen (Figure 1-12) that allows you to launch the Drawing Editor or other resources. The Drawing Editor is composed of a central drawing area, called the “graphics” area, and an array of toolbars, menus, a command line, and other elements, depending on the workspace and other settings that you can change.

Beginning a Drawing

Start tab

When you open an AutoCAD session, the *Start* tab appears for you to choose what drawing you want to work with (Fig. 1-12).

Once you choose to start a new drawing or work with an existing drawing, your screen changes to the Drawing Editor (see Figure 1-13).

NOTE: For clarity, this book displays a white background for the Drawing Editor, whereas the default color for the background is black. It also uses the light color scheme for the ribbon and other tools.

NOTE: AutoCAD adjusts its display to the size of its window. This can result in minimized panels (such as *Utilities* and *Groups* in Figure 1-13) and hidden tool captions in other panels.

Your AutoCAD environment can be customized, as discussed later in the chapter. So, don't worry if what you see on the screen does not precisely match the illustrations in every detail.

2022

FIGURE 1-12

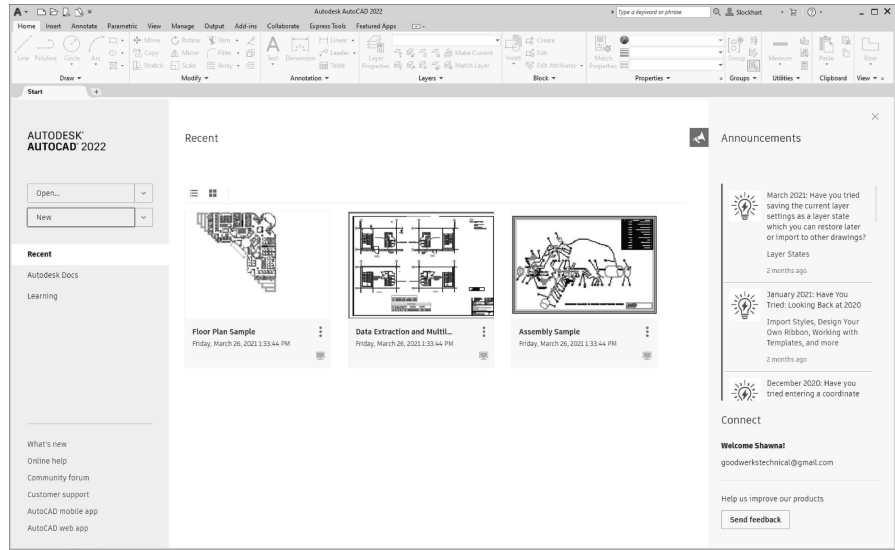
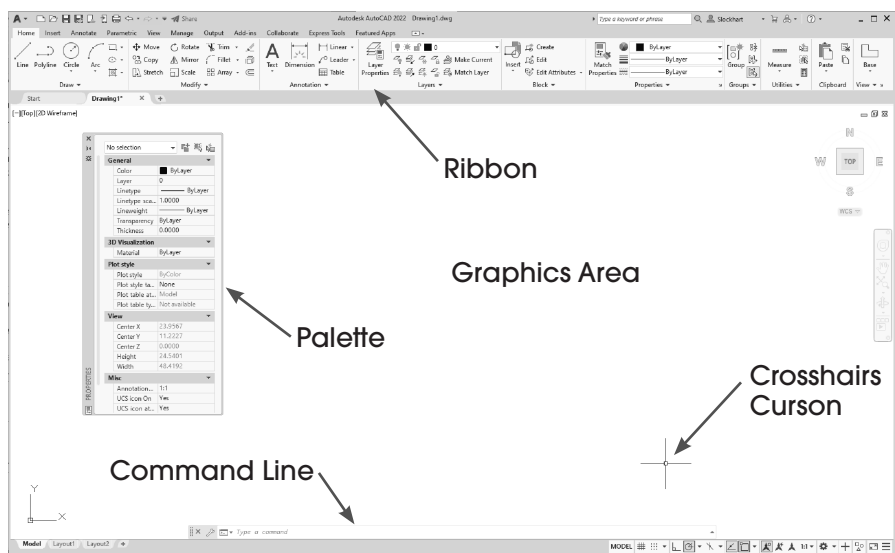

FIGURE 1-13



In the *Start* tab under *Get Started*, you can create a new drawing by selecting the *New* option. The new drawing is based on the most recently used template. You could also select from other templates using the drop-down list using the small arrow at the right of the *New* selection. Normally a template drawing contains no geometry (lines, arcs, circles, etc.) but has specific settings based on what and how you intend to draw. For example, if you intend to use inch units, use the *ACAD.DWT* template drawing; if you intend to use metric units, use the *ACADISO.DWT*.

Alternately, you can select *Open...* to locate and open an existing drawing, *Open a Sheet Set* or *Explore Sample Drawings* that are installed when you install AutoCAD. You can also select from *Recent Documents* (drawings) shown in the list in the center of the *Create* screen.

The center section of the opening screen (*Start* tab) lists the *Recent Documents* that were opened (Fig. 1-12, center). Here you can select from a list rather than browsing for files using the *Open Files* option on the left. The *Recent Documents* list can be changed to large thumbnail images (as shown in Figure 1-12), or to details with no image (file name, date, time).

Drafting & Annotation Workspace

The workspace that appears in the Drawing Editor when you begin drawing for the first time is called the *Drafting & Annotation* workspace. This workspace offers functions for creating 2-dimensional (2D) drawings. Two other workspaces are available for working with 3-dimensional (3D) drawings (see Chapter 33). The basic organization of all workspaces is the same—changing the workspace simply provides different command options from the “Ribbon” near the top of the screen.

Ribbon

The Ribbon is located along the top of the screen (Fig. 1-13) and consists of tabs, panels and tools. Panels are the groups of related tools (commands) between the vertical separators with titles such as *Draw*, *Modify*, and *Layers*. The panels that appear are based on the active tab that is selected (above the panels) such as *Home*, *Insert*, *Annotate*, and so on. For example, selecting the *Home* tab produces the *Draw*, *Modify*, *Annotation*, *Layers*, *Block* and other panels.

Graphics Area

The large central area of the screen is the Graphics Area. It displays the lines, circles, and other objects you create to make up the drawing. The cursor is the intersection of the crosshairs cursor (crossing vertical and horizontal lines that follow the mouse movements). The default size of the graphics area for English settings is 12 units (X or horizontal) by 9 units (Y or vertical). This usable drawing area (12 x 9) is called the drawing Limits and can be changed to any size to fit the application. To see the display of coordinates in the AutoCAD screen, turn on the *Coordinate Display* on the Status Bar. See “Status Bar, Coordinates,” in the next section.

Palettes

When you activate the *Drafting & Annotation* workspace, one or more palettes can be activated as needed on your screen. Figure 1-13 displays the *Properties* palette. Each palette serves a particular function as explained in later chapters. You can close the palettes by clicking on the “X” in the upper corner of the palette.

Command Line

The Command line consists of the one to three text lines (by default) at the bottom of the screen (see Fig. 1-13). Any command that is entered as well as the prompts that AutoCAD issues normally appear here. The Command line gives the current state of drawing activity. It is very important to keep aware of the Command line as you draw while you are learning AutoCAD. You should develop the habit of glancing at the Command line while you work in AutoCAD. The Command line can be set to display any number of lines and it can be moved to another location (see “Customizing the AutoCAD Screen” later in this chapter).

Application Menu and Quick Access Toolbar

All workspaces provide the Application Menu and Quick Access toolbar (Fig. 1-14). The Application Menu is accessed by selecting the large, red letter “A” in the upper-left corner of the AutoCAD window. Selecting this button produces a list of options that allow you to manage drawing files. For example, you can create new drawings, open existing drawings, or save, export, and print drawings. You can also use the search box above the list to search for commands. The Quick Access toolbar, just to the right of the letter “A”, contains frequently used commands such as *Qnew*, *Open*, *Save*, *Undo*, and *Plot*.

FIGURE 1-14

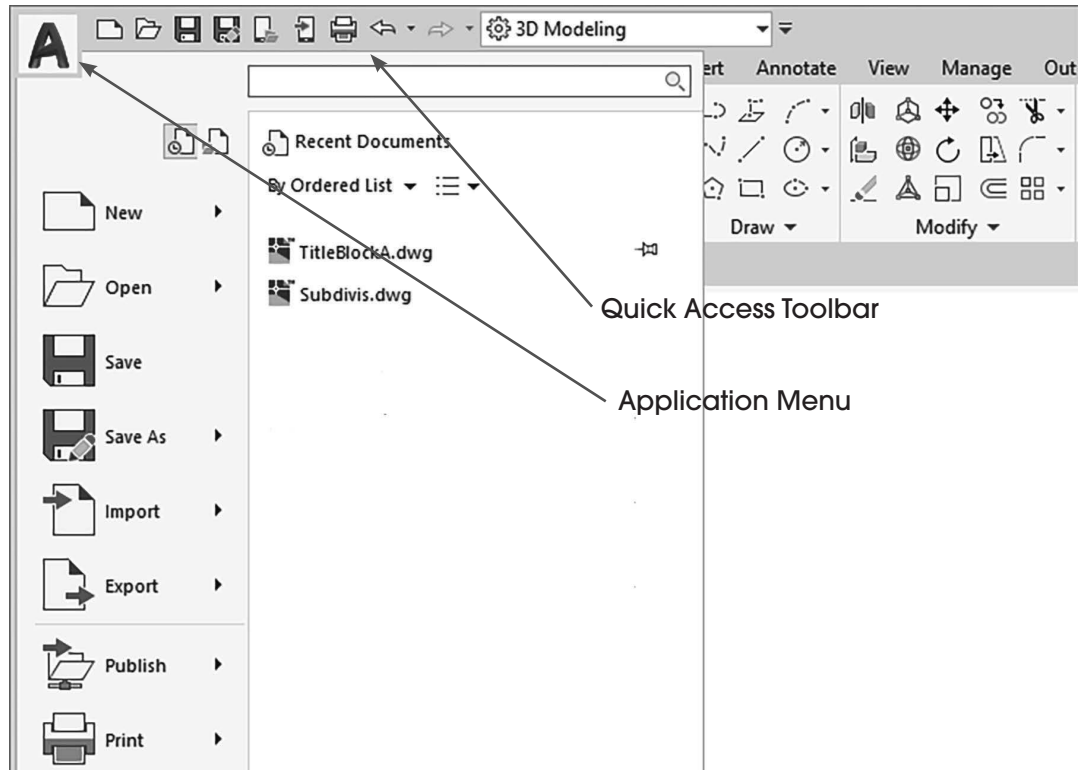
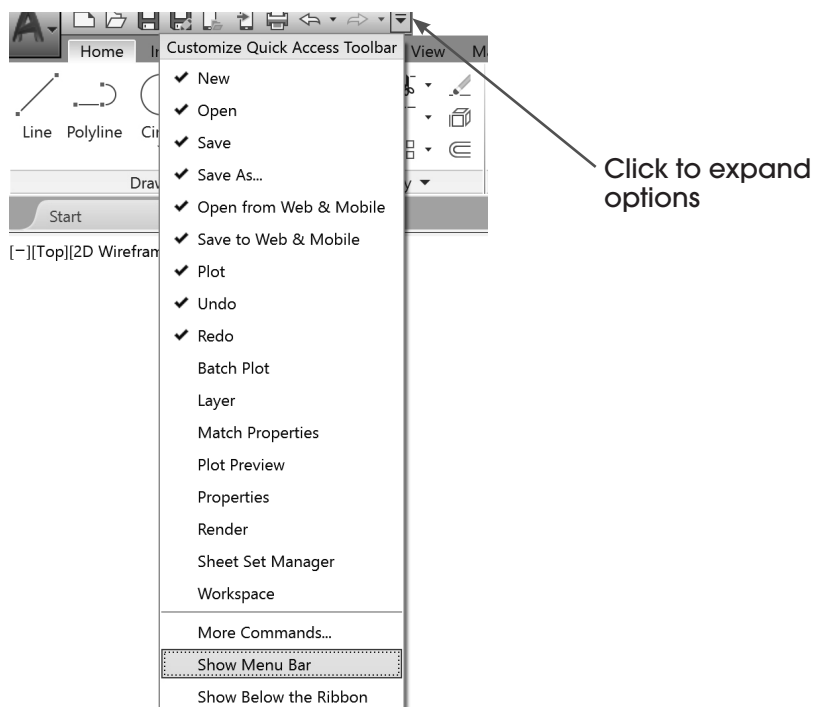

FIGURE 1-15



Menu Bar

A Menu Bar is available that provides a series of pull-down menus along the top of the Drawing Editor just above the Ribbon. The Menu Bar is useful for learning AutoCAD because the command names are listed beside each icon. If you are looking for a particular command, searching the pull-down menus is faster and easier than searching the Ribbon. You can enable the Menu Bar by selecting the *Show Menu Bar* option from the Quick Access toolbar drop-down arrow (Fig. 1-15).



Selecting any of the words in the Menu Bar activates, or pulls down, the respective menu (Fig. 1-16). Selecting a word appearing with an arrow activates a cascading menu with other options. Selecting a word with an ellipsis (. . .) activates a dialog box (see “Dialog Boxes and Palettes”). Words in the pull-down menus are not necessarily the same as the formal command names used when typing commands. Menus can be canceled by pressing Escape or picking in the graphics area.

FIGURE 1-16

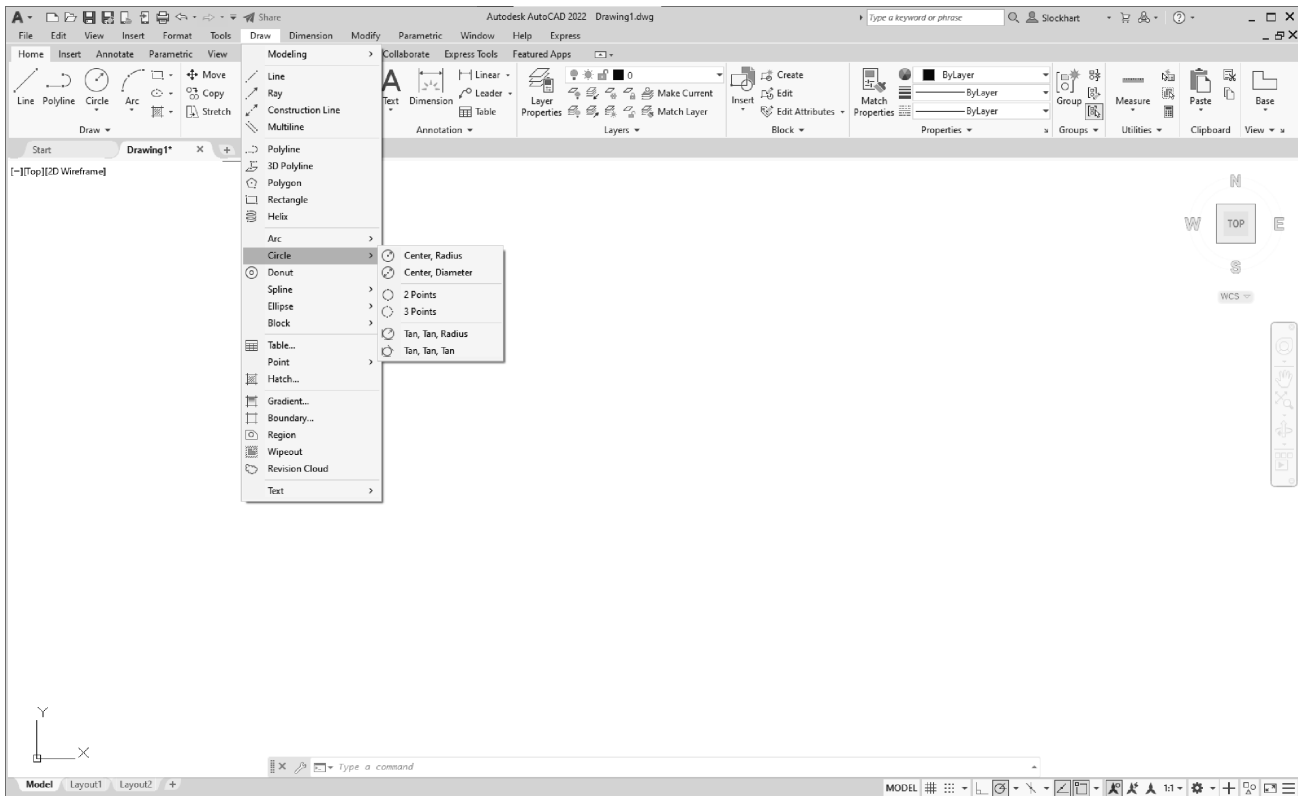

Dialog Boxes and Palettes

Dialog boxes and Palettes provide interfaces for controlling complex commands or a group of related commands. Depending on the command, dialog boxes and palettes allow you to select among multiple options and sometimes give a preview of the effect of selections. The *Layer Properties Manager* palette (Fig. 1-17) gives complete control of layer colors, line-types, and visibility.

FIGURE 1-17

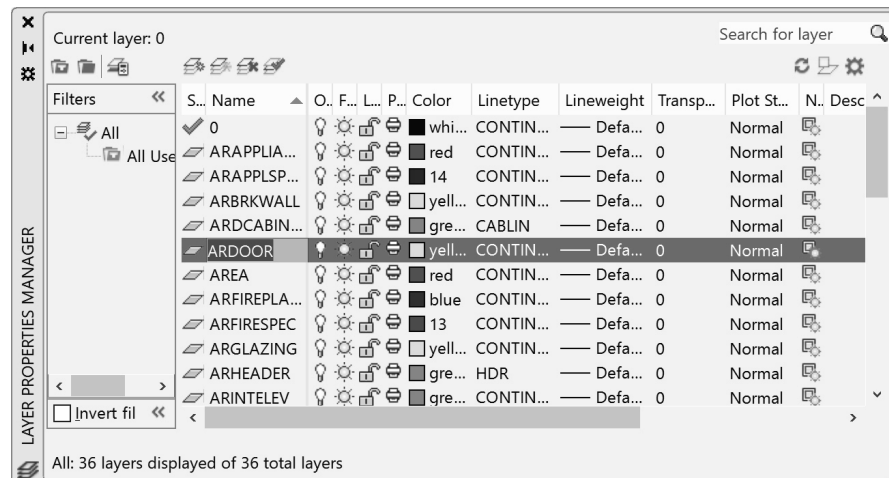

Dialog boxes and palettes can be invoked by typing a command, selecting an icon button, or PICKing from the menus. For example, typing *Layer*, PICKing the *Layer Properties Manager* button, or selecting *Layer* from the *Format* pull-down menu causes the *Layer Properties Manager* to appear. Palettes and dialog boxes can be resized to display more or less information. The basic elements of a dialog box are listed below.

Button	Resembles a push button and triggers some type of action.
Edit box	Allows typing or editing of a single line of text.
Image tile	A button that displays a graphical image.
List box	A list of text strings from which one or more can be selected.
Drop-down list	A text string that drops down to display a list of selections.
Radio button	A group of buttons, only one of which can be turned on at a time.
Checkbox	A checkbox for turning a feature on or off (displays a check mark when on).

Shortcut Menus

AutoCAD makes use of shortcut menus that are activated by pressing the right mouse button (sometimes called right-click menus). Shortcut menus give quick access to command options. There are many shortcut menus to list since they are based on the active command or dialog box. The menus fall into five basic categories listed here.

Default Menu

The default menu appears when you right-click in the drawing area and no command is in progress. Using this menu, you can repeat the last command, select from recent input (like using the up and down arrows), use the Windows Cut, Copy, Paste functions, and select from other viewing and utility commands (Fig. 1-18).

FIGURE 1-18

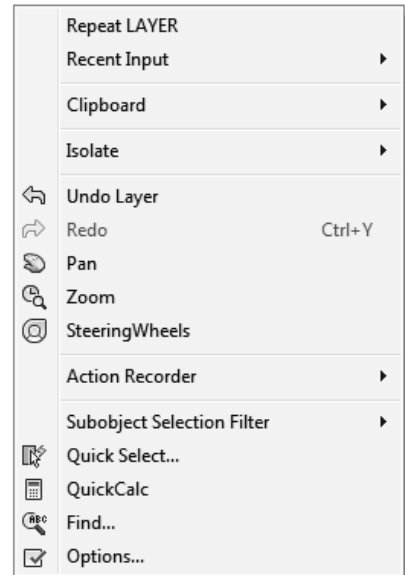

Edit-Mode Menu

This menu appears when you right-click when objects have been selected but no command is in progress. Note that several of AutoCAD's *Modify* commands are available on the menu such as *Erase*, *Move*, *Copy*, *Scale*, and *Rotate* (Fig. 1-19).

FIGURE 1-19

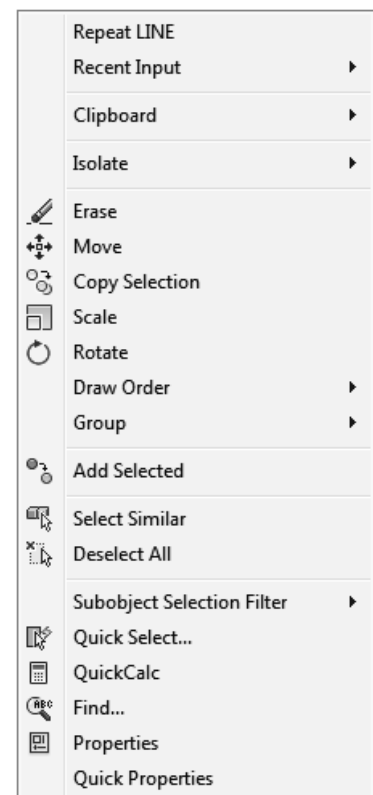

NOTE: Edit mode shortcut menus do not appear if the *PICKFIRST* system variable is set to 0 (see "*PICKFIRST*" in Chapter 20).

Command-Mode Menu

These menus appear when you right-click when a command is in progress. This menu changes since the options are specific to the command (Fig. 1-20).

FIGURE 1-20

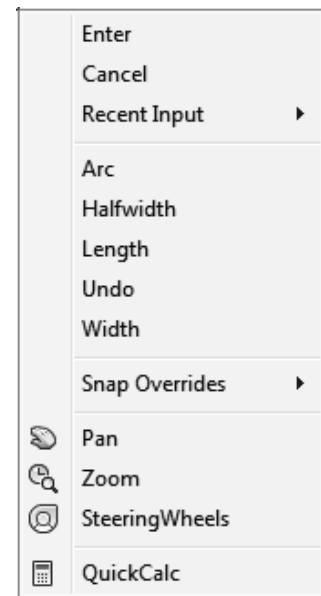

Dialog-Mode Menu

When the pointer is in a dialog box or tab and you right-click, this menu appears. The options on this menu can change based on the current dialog box (Fig. 1-21).

FIGURE 1-21

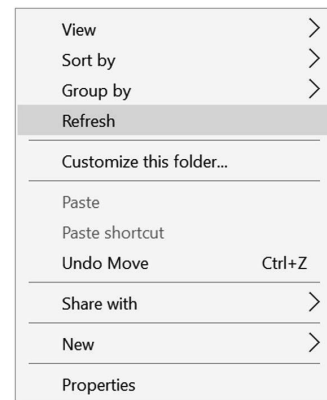

Other Menus

There are other menus that can be invoked. For example, a menu appears if you right-click in the Command line area.

Because there are so many shortcut menus, don't be too concerned about learning these until you have had some experience. The best advice at this time is just remember to experiment by right-clicking often to display the possible options.

Command Entry Using the Keyboard

Although commands are accessible using toolbars, the dashboard, pull-down menus, and shortcut menus, you can enter the command using the keyboard. As you type the letters, they appear on the Command line (near the bottom of the screen) or in the *Dynamic Input* box near the cursor (see "Drawing Aids," "Dynamic Input"). Using the keyboard to type in commands offers several features:

Command name	Type in the full command name.
Command alias	Type the one- or two-letter shortcut for the command (see App. A).
Accelerator keys	Type a Ctrl key plus another key to invoke the command (see App. B).
Up and down arrows	Use the up and down arrows to cycle through the most recent input.
Tab key	Type in a few letters and press the Tab key to "AutoComplete" the command.

Accelerator Keys (Control Key Sequences)

Several control key sequences (holding down the Ctrl key or Alt key and pressing another key simultaneously) invoke regular AutoCAD commands or produce special functions (see App. B).

Special Key Functions

Esc	The Esc (escape) key cancels a command, menu, or dialog box or interrupts some processes.
Space bar	In AutoCAD, the space bar performs the same action as the Enter key. Only when you are entering text into a drawing does the space bar create a space.
Enter	If Enter or the space bar is pressed when no command is in use (the open Command: prompt is visible), the last command used is invoked again.

Mouse Buttons

Depending on the type of mouse used for cursor control, a different number of buttons is available. In any case, the buttons normally perform the following tasks:

left button	PICK	Used to select commands or pick locations on the screen.
right button	Enter or shortcut menu	Depending on the status of the drawing or command, this button either performs the same function as the Enter key or produces a shortcut menu.
wheel	<i>Pan</i>	If you press and drag, you can pan the drawing about on the screen.
	<i>Zoom</i>	If you turn the wheel, you can zoom in and out centered on the location of the cursor.

COMMAND ENTRY

Methods for Entering Commands

There are many possible methods for entering commands in AutoCAD depending on your system configuration. Generally, most of the methods can be used to invoke a particular commonly used command or dialog box.

1. Keyboard Type the command name, command alias, or accelerator keys at the keyboard.
2. Menu Bar Select the command or dialog box from a pull-down menu.
3. Tools (icon buttons) Select the command or dialog box by PICKing a tool (icon button) from a toolbar, palette, or Ribbon.
4. Shortcut menus Select the command from the right-click shortcut menu. Right-clicking produces a shortcut menu depending on whether a command is active, objects are selected, or the pointer is in a dialog box.

Understanding the “Command Tables” in this Book

Command tables, like the one below, are used throughout this book to show the possible methods for entering a particular command. The table shows the icon used in the toolbars, the palettes, and the Ribbon, indicates the tab and panel on the Ribbon for locating the icon, gives the selections to make for the pull-down menu, gives the correct spelling for entering commands and command aliases at the keyboard, and gives the shortcut menu and option. This example uses the *Line* command.

Line



Ribbon	Menu Bar	Command (Type)	Alias (Type)	Shortcut
<i>Home</i> <i>Draw</i> <i>Line</i>	<i>Draw</i> <i>Line</i>	<i>Line</i>	<i>L</i>	...

Command Entry Methods Practice

Start AutoCAD. Use the **ACAD.DWT** template. Invoke the *Line* command using each of the command entry methods as follows.

1. Type the command

Steps	Command Prompt	Perform Action	Comments
1.		press Escape if another command is in use	
2.	Command:	type <i>Line</i> and press Enter	
3.	LINE Specify first point:	PICK any point	a “rubberband” line appears
4.	Specify next point or [Undo]:	PICK any point	another “rubberband” line appears
5.	Specify next point or [Undo]:	press Enter	to complete command

2. Type the command alias

Steps	Command Prompt	Perform Action	Comments
1.		press Escape if another command is in use	
2.	Command:	type <i>L</i> and press Enter	
3.	LINE Specify first point:	PICK any point	a “rubberband” line appears
4.	Specify next point or [Undo]:	PICK any point	another “rubberband” line appears
5.	Specify next point or [Undo]:	press Enter	to complete command

3. Menu Bar

Steps	Command Prompt	Perform Action	Comments
1.	Command:	select the <i>Draw</i> menu from the menu bar	
2.	Command:	select <i>Line</i>	menu disappears
3.	LINE Specify first point:	PICK any point	a “rubberband” line appears
4.	Specify next point or [Undo]:	PICK any point	another “rubberband” line appears
5.	Specify next point or [Undo]:	press Enter	to complete command

4. Ribbon (*Drafting & Annotation* workspace)

Steps	Command Prompt	Perform Action	Comments
1.	Command:	select the <i>Line</i> icon from the <i>Draw</i> panel on the <i>Home</i> tab	the <i>Line</i> tool is the first icon in the <i>Draw</i> panel
2.	LINE Specify first point:	PICK any point	a “rubberband” line appears
3.	Specify next point or [Undo]:	PICK any point	another “rubberband” line appears
4.	Specify next point or [Undo]:	press Enter	to complete command

5. Shortcut menu

Steps	Command Prompt	Perform Action	Comments
1.	Command:	right-click in the drawing area and select <i>Repeat LINE</i> from menu	<i>Repeat LINE</i> should be first in the list
2.	LINE Specify first point:	PICK any point	a “rubberband” line appears
3.	Specify next point or [Undo]:	PICK any point	another “rubberband” line appears
4.	Specify next point or [Undo]:	press Enter	to complete command

When you are finished practicing, use the Application Menu or the *File* menu and select *Exit* to exit AutoCAD. You do not have to “Save Changes.”

DRAWING AIDS

This section explains several features that appear near the bottom of the Drawing Editor including the Status Bar drawing aids, Model and Layout tabs, and the Text window.

Status Bar

The Status Bar appears at the bottom of the AutoCAD window and contains a set of icons that allow you to turn on or off drawing aids such as *Grid*, *Snap*, *Dynamic Input*, and *Polar Tracking* (Fig. 1-22, bottom). Gray icons indicate the feature is off and blue icons indicate the feature is on. You can turn some features on or off using a function key as an alternative to clicking the icons, such as F7 to turn *Grid* on or off (see “Function Keys” later in this chapter).

FIGURE 1-22

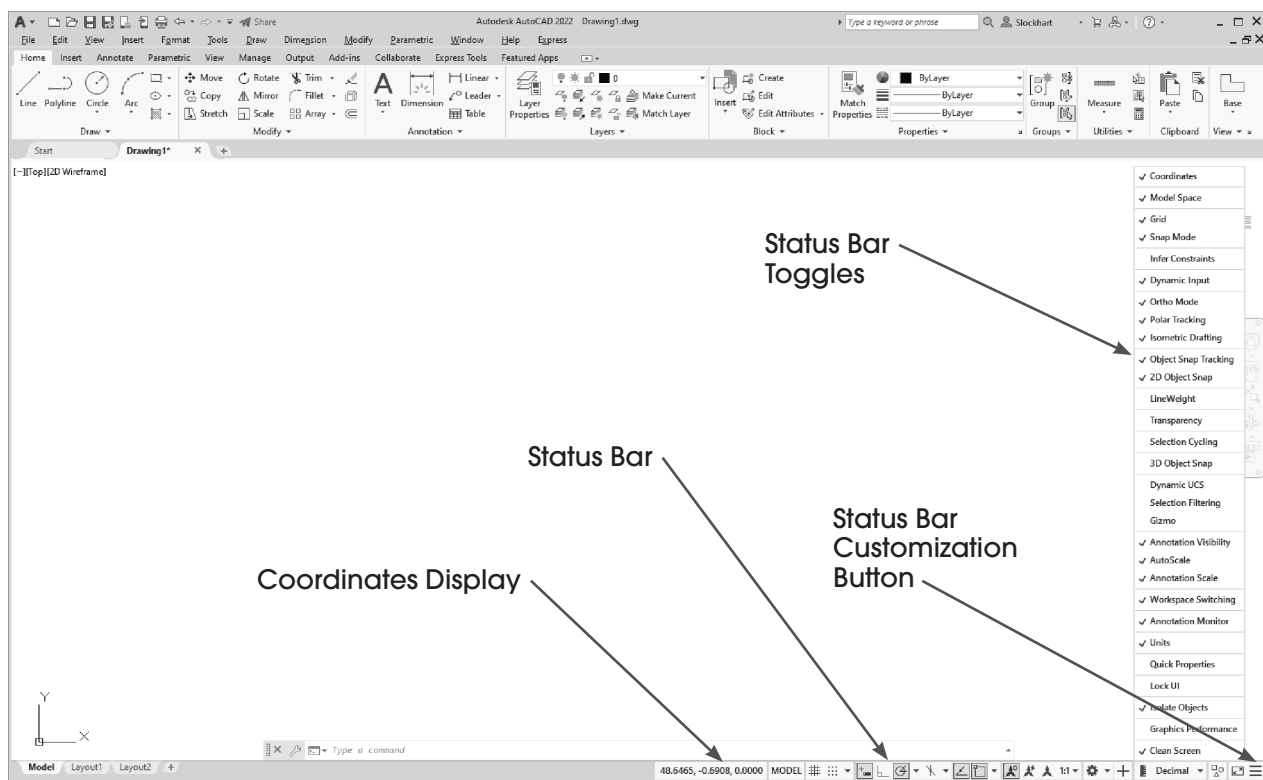

You can determine which drawing aid icons appear on the Status Bar by using the *Customization* button (Fig. 1-22, bottom-right corner). This button produces a list of drawing aids that you check or uncheck (Fig. 1-22, right). Therefore, checking or unchecking a word in the list determines if that icon appears on the Status Bar.

Coordinates

The Coordinate display (sometimes referred to as “Coords”) displays the position of the cursor (cross-hairs) in X, Y, and Z coordinates. The coordinate display is located at the left end of the Status Bar (see Fig. 1-22). This can be very helpful when you draw because the current coordinate position of the cursor is displayed as the cursor moves, sometimes called “cursor tracking.” It is recommended to turn the coordinates on while you begin learning AutoCAD. You can click on the numbers to turn this feature on or off. The default setting (in the acad.dwt template) displays decimal format with four places to the right of the decimal. Although this format can be changed, AutoCAD always records 14 significant places for every ordinate!



When the coordinate display is turned on, there are four possible formats: *Absolute*, *Relative*, *Geographic*, and *Specific*. Access these options by right-clicking on the coordinate display.

- Absolute* This option tracks the current cursor location in absolute coordinates (relative to 0,0,0).
- Relative* This option tracks the current cursor location in coordinates relative to the last point established but in a polar format (distance and angle). This option appears only if a point has been established, such as when the first point of a Line has been designated.
- Geographic* Use this option when you have set a geographic location in the drawing (*Geographiclocation* command).
- Specific* This option displays the coordinates only when you click to select a point rather than continuously tracking the current location of the cursor.

MODEL/PAPER (Model Space or Paper Space)

Next to the Coordinate display the word *PAPER* or *MODEL* appears by default. There are two spaces in AutoCAD—Model Space, where you draw, and Paper Space, where you prepare to print a drawing. See Chapter 13 for an introduction to Paper Space and Model Space.

Grid (Grid Mode, F7)

This drawing aid can be used to give a visual reference of units of length. The *Grid* default value for English settings (acad.dwt template) is .5 units. The *Grid* command or *Drawing Aids* dialog box allows you to change the interval to any value. The *Grid* is not part of the geometry and is not plotted. Figure 1-23 displays a *Grid* of .5. *Snap* and *Grid* are independent functions—they can be turned on or off independently.

FIGURE 1-23

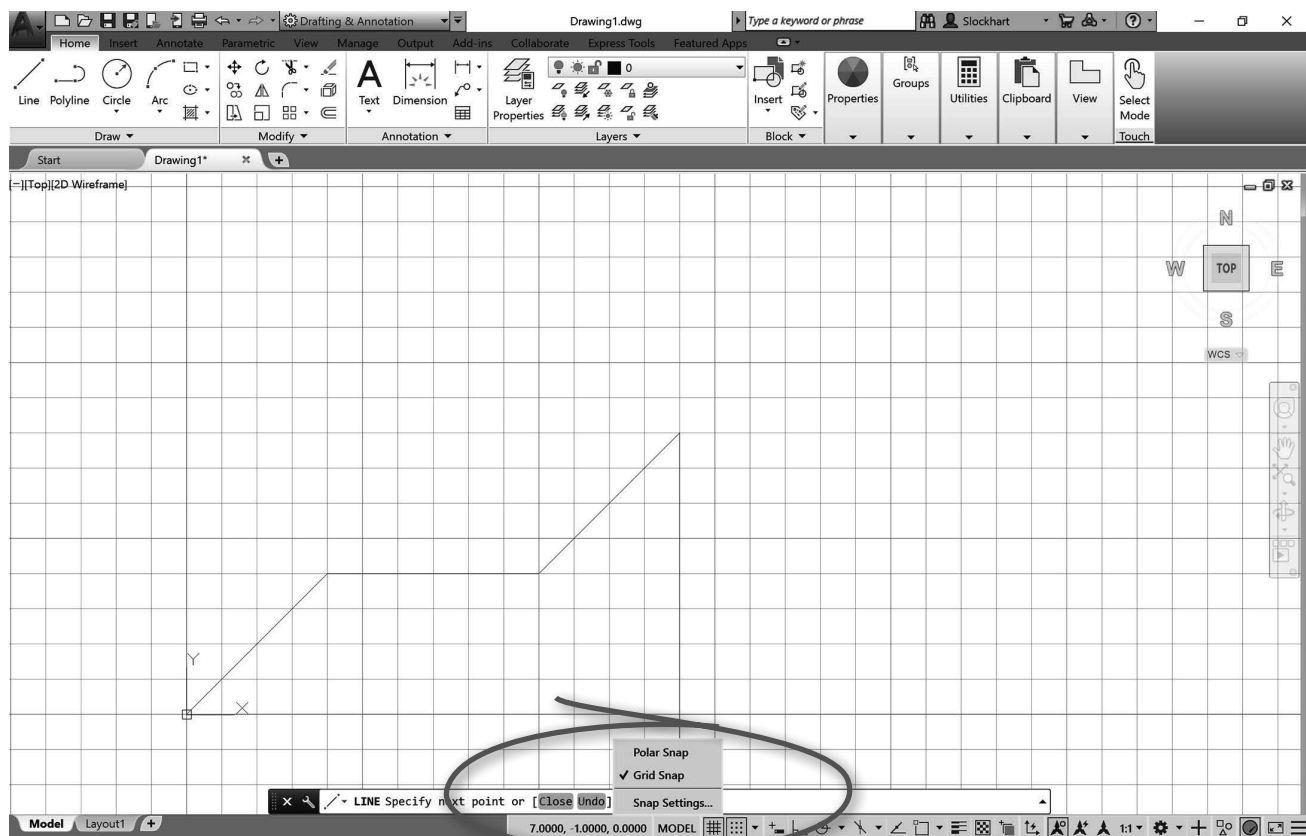

Snap Mode (F9)

Snap has two modes in AutoCAD: *Grid Snap* and *Polar Snap*. Only one of the two modes can be active at one time. *Grid Snap* is a function that forces the cursor to “snap” to regular intervals (.5 units is the default setting), which aids in creating geometry accurate to interval lengths. You can use the *Snap* command or the *Drafting Settings* dialog box to specify any value for the *Snap* increment. Figure 1-23 displays a *Snap* setting of .5 (note the values in the coordinate display).

The other mode of *Snap* is *Polar Snap*. *Polar Snap* forces the cursor to snap to regular intervals along angular lines. *Polar Snap* is functional only when *Polar Tracking* is also toggled on since it works in conjunction with *Polar Tracking*. The *Polar Snap* interval uses the *Grid Snap* setting by default but can be changed to any value using the *Snap* command or the *Drafting Settings* dialog box. *Polar Snap* is discussed in detail in Chapter 3.

Since you can have only one *Snap* mode on at a time (*Grid Snap* or *Polar Snap*), you can select which of the two is on by right-clicking on the icon on the Status Bar. You can also access the *Drafting Settings* dialog box by selecting *Snap Settings...* from the pop-up menu (see Figure 1-23).

Infer Constraints

Enabling *Infer Constraints* mode automatically applies constraints between the object you are creating or editing and the object or points associated with object snaps. For most drawings, turn this feature off.

Dynamic Input (F12)

Dynamic Input is a feature that helps you visualize and specify coordinate values and angular values when drawing lines, arcs, circles, etc. *Dynamic Input* may display absolute Cartesian coordinates (X and Y values) or relative polar coordinates (distance and angle) depending on the current command prompt and the settings you prefer (Fig. 1-24).

FIGURE 1-24

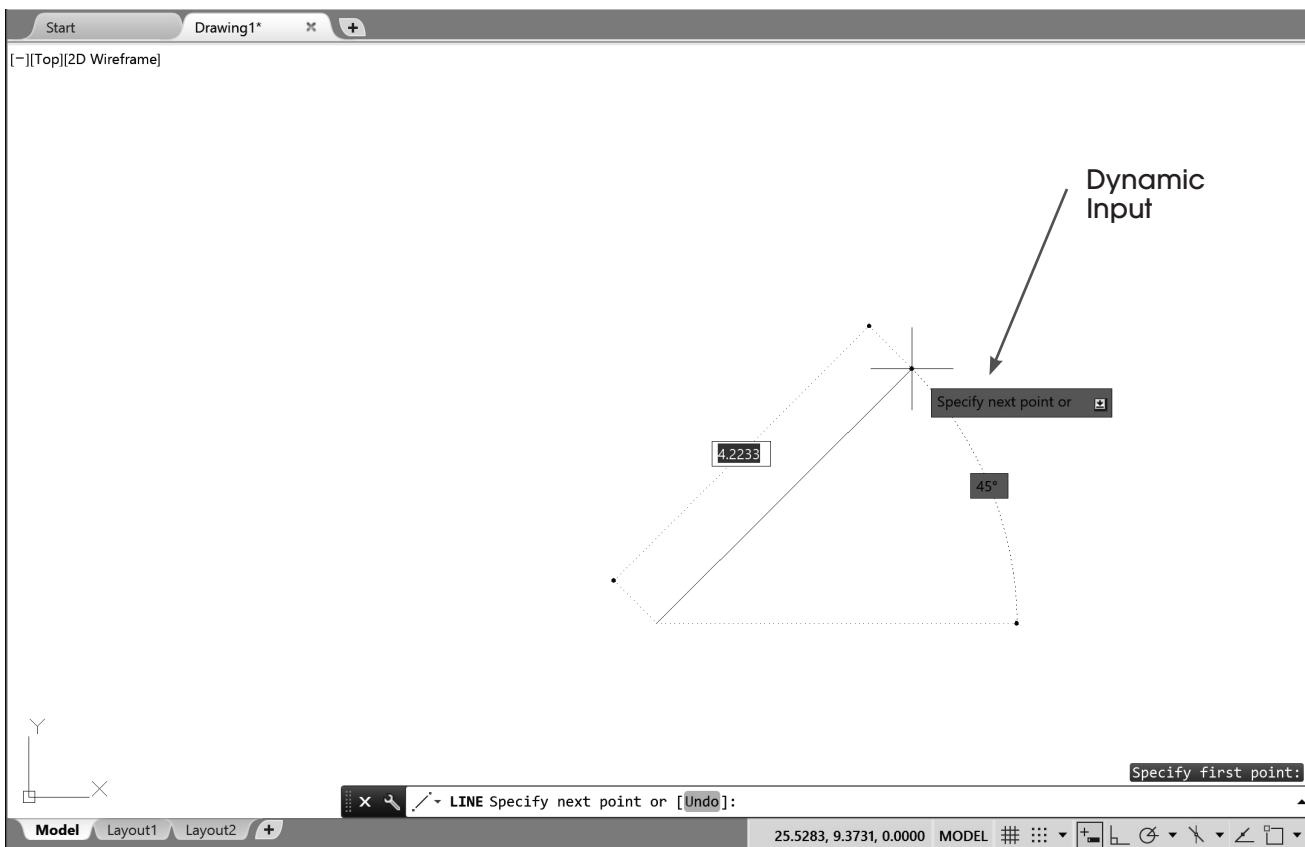

Dynamic Input is explained further in Chapter 3. You can toggle *Dynamic Input* on or off by using the icon or the F12 key. You can change the format of the display during input by right-clicking on the icon and selecting *Dynamic Input Settings* from the menu. For example, you can set *Dynamic Input* to display a “tool tip” that gives the current coordinate location of the cursor (cursor tracking mode) when no commands are in use.

Ortho Mode (F8)

If *Ortho Mode* is on, lines are forced to an orthogonal alignment (horizontal or vertical) when drawing. *Ortho* is often helpful since so many drawings are composed mainly of horizontal and vertical lines.

Polar Tracking (F10)

Polar Tracking makes it easy to draw lines at regular angular increments, such as 30, 45, or 90 degrees. The F10 key or the icon button toggles *Polar Tracking* on or off. When *Polar Tracking* is on, a polar tracking vector (a faint dotted line) appears when the “rubber band” line approaches the desired angular increment as shown in Figure 1-25. By default, *Polar Tracking* is set to 90 degrees, but can be set to any angular increment by right-clicking on the icon and selecting an angle option (bottom-right, Figure 1-25).

FIGURE 1-25

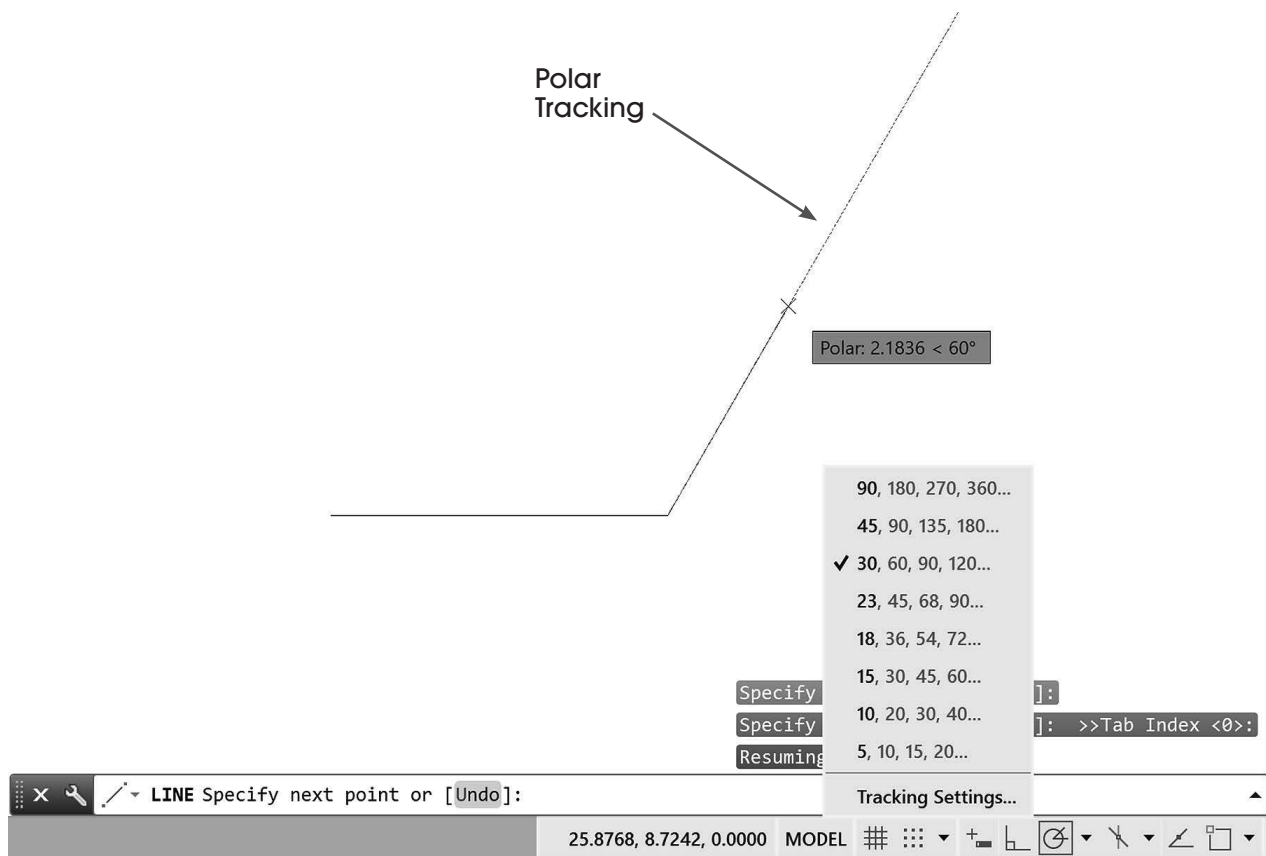

Isometric Drafting

This drawing aid helps you draw an isometric drawing by setting the *Snap Mode* and the *Grid Mode* to a 30-degree orientation. See Chapter 25, *Pictorial Drawings*, for more information.

Object Snap Tracking

The *Object Snap Tracking* feature is discussed in Chapter 7, *Object Snap and Object Snap Tracking*.

2D Object Snap

Object Snap allows you to easily “snap,” or attach, to object endpoints, midpoints, centers, etc. The *Object Snap* feature is discussed in detail in Chapter 7.

LineWeight

Use this aid to display line thicknesses that may be applied to objects. See Chapter 11.

Transparency

Imported images can have a transparency quality applied. Use this icon to display or not display transparency. See Chapter 11 for a full explanation.

Selection Cycling

Chapter 4 explains how to use *Selection Cycling*.

3D Object Snap

You can snap to vertices, midpoints, faces, etc. of 3D objects. This icon is used to turn this feature on or off.

Dynamic UCS

You can use *Dynamic User Coordinate Systems* when creating or editing 3D objects. See Chapter 35 for more information.

Selection Filtering

Discussed in Chapter 20, *Advanced Selection Sets*, this feature assists when selecting objects for editing.

Gizmo

A *Gizmo* can be used to create and edit 3D objects. This feature is discussed with the solid modeling information.

Annotation Visibility

Dimensions and text objects can be made to change size automatically. This option allows you to see changes made by scale changes to the current viewport.

AutoScale

This feature toggles the automatic scaling of annotation objects on or off.

Annotation Scale

This pop-up list of standard scales allows you to set the desired scale for annotation in the current viewport.

Workspace Switching

Use this list to select from the three workspaces (*Drafting & Annotation*, *3D Basics*, and *3D Modeling*) as well as control the customization of your workspaces.

Annotation Monitor

Dimensions are associated (attached) to objects. You can use the *Annotation Monitor* to flag dimensions that lose associativity when objects are moved or updated.

Units

When turned on, the current units for the drawing are displayed such as decimal or feet and inches.

Quick Properties

When you select objects to edit, a *Quick Properties* panel (giving properties of the selected objects) may appear based on your setting with this icon. See Chapter 16.

Lock UI

Use *Lock UI* to “lock” in place user interface elements such as windows, palettes, and toolbars from being accidentally or otherwise moved or changed.

Isolate Objects

This icon provides a quick method for using the *Hideobjects*, *Isolateobjects*, and *Unisolateobjects* commands. See Chapter 20 for more information on these features.

Graphics Performance

This icon provides access to the *Graphics Performance* dialog box where you can tune the performance of your graphics display.

Clean Screen

Clean Screen removes the Ribbon so you have more screen area to draw. See the “Customizing the AutoCAD Screen” section next in this chapter.

Function Keys

Several function keys are usable with AutoCAD. They offer a quick method of turning on or off (toggling) drawing aids and other features.

F1	<i>Help</i>	Opens a help window providing written explanations on commands and variables.
F2	<i>Text window</i>	Activates the text window showing the previous command line activity (command history).
F3	<i>Object Snap</i>	Turns Running <i>Object Snaps</i> on or off. If no Running <i>Object Snaps</i> are set, F3 produces the <i>Object Snap Settings</i> dialog box (discussed in Chapter 7).
F4	<i>3D Object Snap</i>	Turns <i>3D Object Snap</i> on or off.
F5	<i>Isoplane</i>	When using an <i>Isometric</i> style <i>Snap</i> and <i>Grid</i> setting, toggles the cursor (with <i>Ortho</i> on) to draw on one of three isometric planes.
F6	<i>Dynamic UCS</i>	Turns <i>Dynamic UCS</i> on or off for 3D modeling (see Chapters 35 and 36).
F7	<i>Grid</i>	Turns the <i>Grid</i> on or off.
F8	<i>Ortho</i>	Turns <i>Ortho</i> on or off.
F9	<i>Snap</i>	Turns <i>Snap</i> on or off.
F10	<i>Polar Tracking</i>	Turns <i>Polar Tracking</i> on or off.
F11	<i>Object Snap Tracking</i>	Turns <i>Object Snap Tracking</i> on or off.
F12	<i>Dynamic Input</i>	Turns <i>Dynamic Input</i> on or off.

AutoCAD Text Window

Pressing the F2 key activates the *Text Window*, sometimes called the *Command History* (Fig. 1-26). Here you can see the text activity that occurred at the Command line—kind of an “expanded” Command line. Press F2 again to close the text window. The right-click menu in this text window provides several options. If you highlight text in the window, you can then *Paste to Command line*, *Copy* it to another program such as a word processor, *Copy History* (entire command history) to another program, or *Paste* text into the window. The *Options* choice invokes the *Options* dialog box (discussed later).

FIGURE 1-26

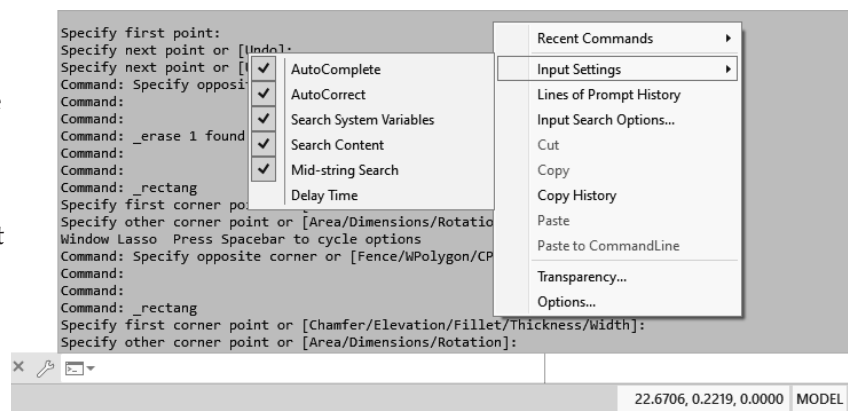

Several options in the right-click menu of the text window allow you to customize how the Command line operates. For example, selecting *Input Settings* provides options for how AutoCAD responds as you type words at the Command line. Here you can toggle *AutoComplete* and *AutoCorrect* as well as what content in the drawing is searched when you begin typing.

Selecting *Input Search Options* from the text window right-click menu invokes the dialog box shown in Figure 1-27. This box provides complete control of how AutoCAD completes, corrects, and searches as you type words into the Command line.

FIGURE 1-27

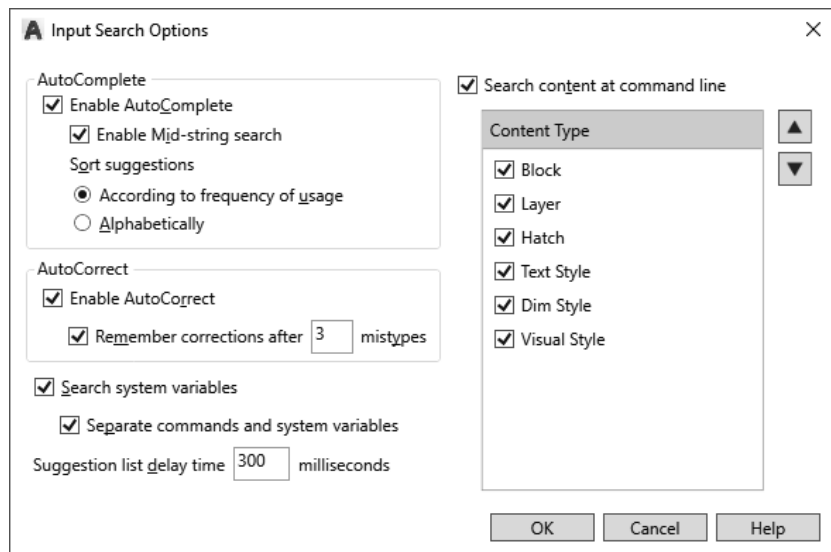

Selecting the *Transparency* option produces a window that controls the percentage of transparency you prefer for the Command line. Use the *Lines of Prompt History* to specify the maximum number of text lines that appear when the Command line automatically expands as you work. The setting is saved in the *CLIPROMPTLINES* system variable and is set to 3 by default.

Model Space and Layouts

Model Space

When you begin a drawing, model space is the current drawing space. This area is also known as the *Model* tab (Fig. 1-28, lower-left). In this area you should create the geometry representing the subject of your drawing, such as a floor plan, a mechanical part, or an electrical schematic. Dimensions are usually created and attached to your objects in model space.

FIGURE 1-28

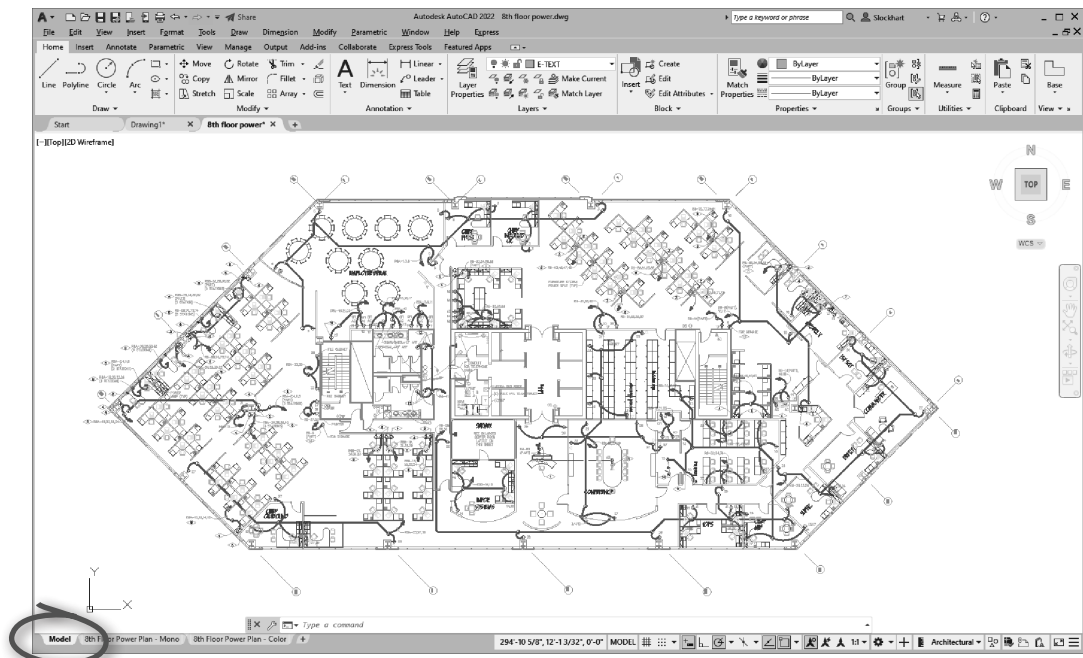

Layouts

When you are finished with your drawing, you can print it directly from model space or switch to a layout (Fig. 1-29). Layouts, sometimes known as paper space, represent sheets of paper that you print on.

You must use several commands to set up the layout to display the geometry and set all the printing options such as scale, paper size, device, and so on. Printing and layouts are discussed in detail in Chapters 13, 14, and 32.

FIGURE 1-29

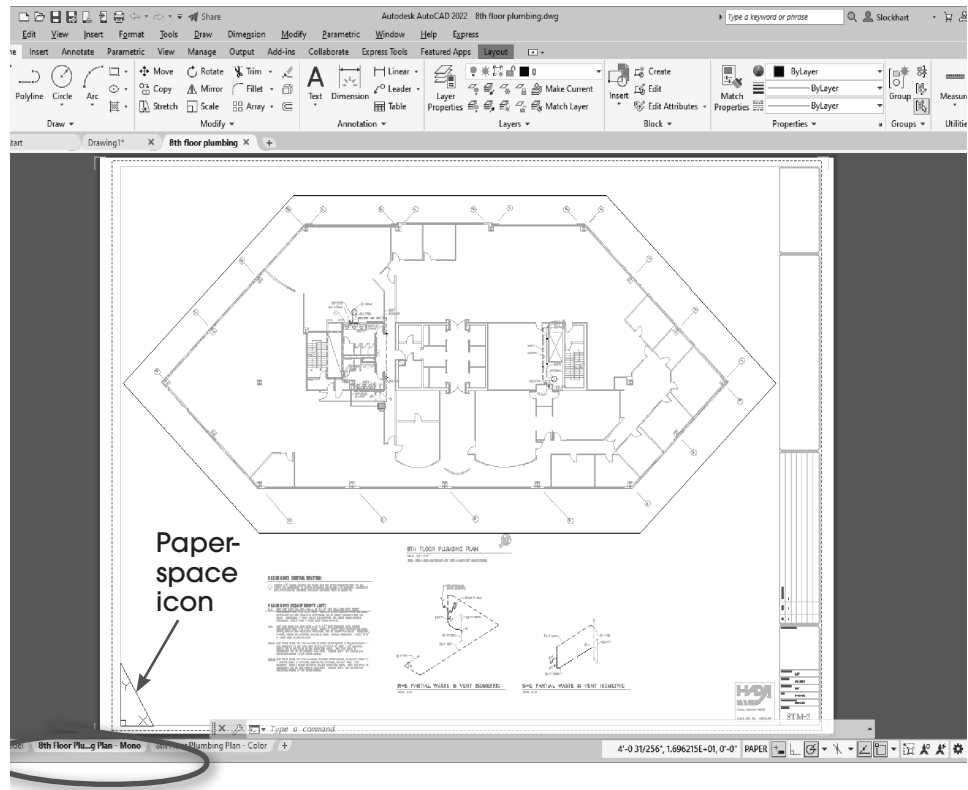

CUSTOMIZING THE AutoCAD SCREEN

Toolbars

Many toolbars are available, each with a group of related commands for specialized functions. For example, when you are ready to dimension a drawing, you can activate the *Dimension* toolbar for efficiency.

To activate toolbars, select *Toolbars* from the *Tools* pull-down menu. Selecting any toolbar name makes that toolbar appear on the screen (Fig. 1-30). If a toolbar is already visible on the screen, you can right-click on it to produce a list of all available toolbars.

FIGURE 1-30

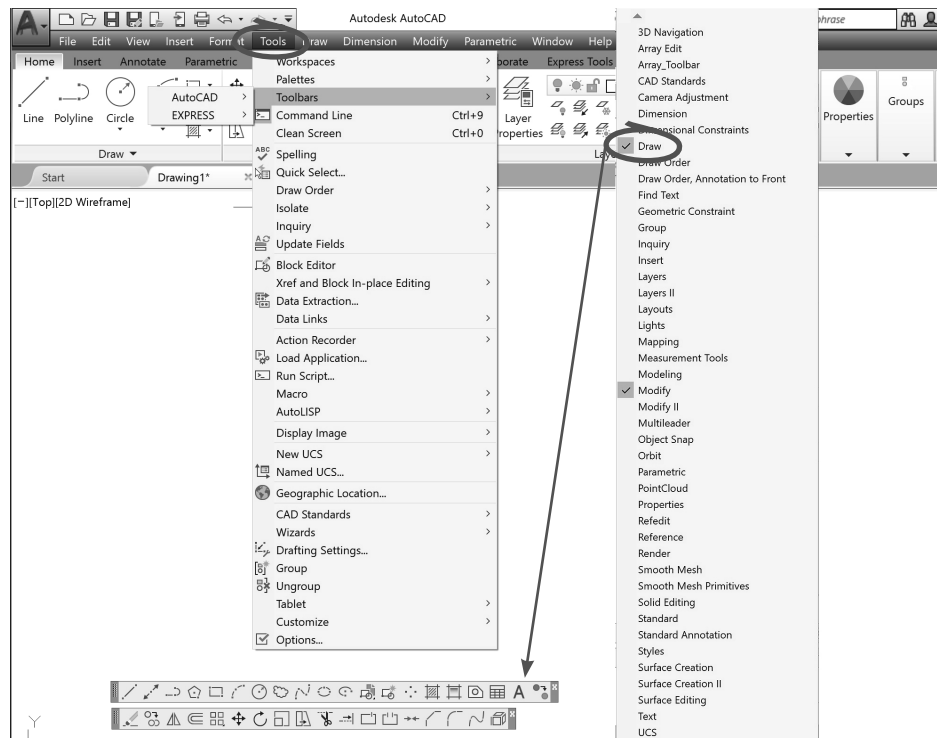

You can also type the *-Toolbar* command (don't forget the hyphen) at the Command line. Next, type the name of the toolbar you want to appear, such as *Draw* or *Dimension*. Use the *Show* option to make the toolbar appear on the screen. (The *Toolbar* command [without the hyphen] produces the *Customize User Interface* dialog box that is used for customizing the Ribbon, menus, toolbars, palettes, and workspaces.)

By default, most toolbars that are newly activated are floating (see Fig. 1-30). A floating toolbar can be easily moved to any location on the screen if it obstructs an important area of a drawing. Placing the pointer in the title background allows you to move the toolbar by holding down the left button and dragging it to a new location (Fig. 1-31). Floating toolbars can also be resized by placing the pointer on the narrow border until a two-way arrow appears, then dragging left, right, up, or down.

A floating toolbar can be docked against any border (right, left, top, bottom) by dragging it to the desired location (Fig. 1-32). Several toolbars can be stacked in a docked position. By the same method, docked toolbars can be dragged back onto the graphics area.

Toolbars can be removed from the screen by clicking once on the "X" symbol in the upper right of a floating toolbar.

FIGURE 1-31

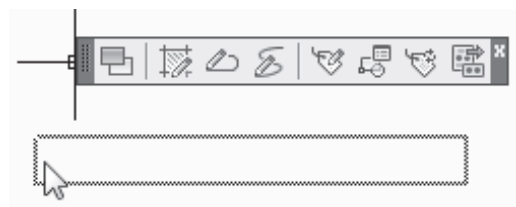

FIGURE 1-32

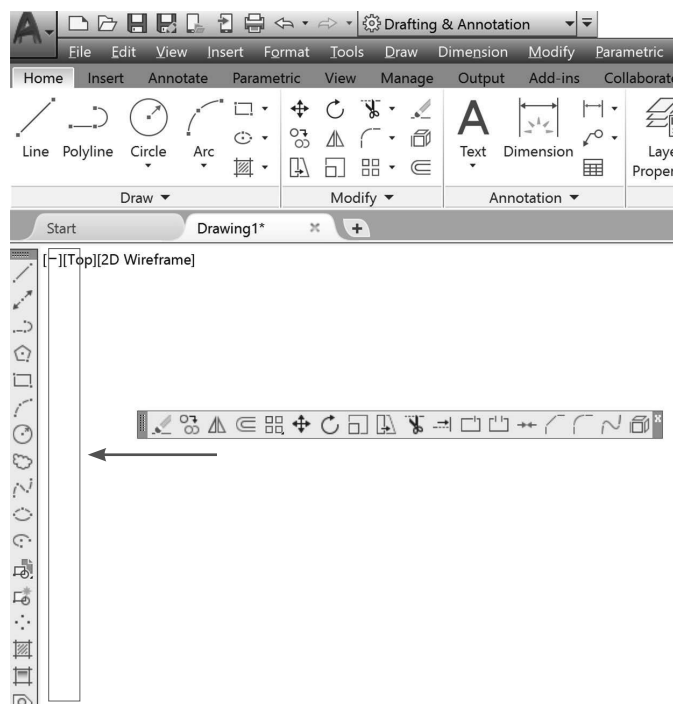
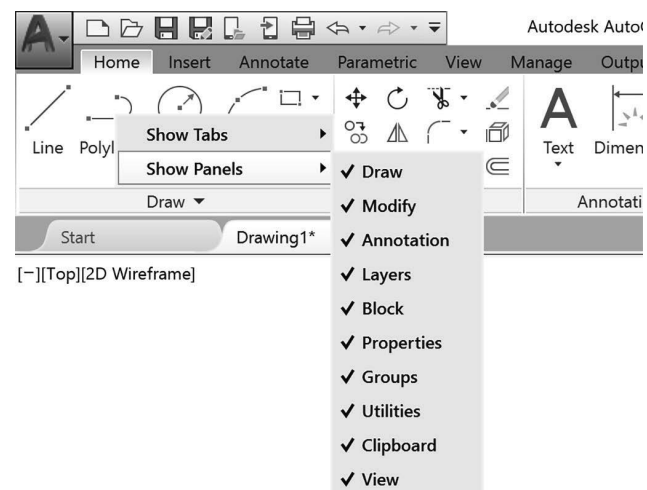

FIGURE 1-33



Ribbon

You can customize the Ribbon to your liking. Right-click on any tab to produce the shortcut menu shown in Figure 1-33. You can select which tabs and panels you want to appear. For example, if you want only certain panels to appear for a specific tab, first click on the tab, then use this menu to produce a list of toggles for all the panels that can appear for that tab, as shown in the figure. If you choose *Undock* from the shortcut menu the Ribbon is converted to a palette. You can drag the Ribbon palette to the right or left side of the screen or back to the top of the screen.

You can further customize how much of the panels appear in the Ribbon. There is a very small drop-down arrow just to the right of the last tab (Figure 1-34, top right). Use this list to choose how you want the panels in each tab to appear. You can choose *Minimize to Panel Titles* to increase space in the graphics area. With this option, only the panel titles appear without the tools (Fig. 1-34). To activate a panel and display the tools contained in the panel, momentarily rest the pointer on the panel title until the full panel pops down to display the full set of tools (Fig. 1-34, top left).

Clean Screen

You can change the AutoCAD window from a normal window to a window with no toolbars or Ribbon (Fig. 1-35). Notice that the Command line, Status Bar, and pull-down menus (if activated) are still visible. This is useful if you want to maximize the drawing area to view a drawing or to make a presentation. Activate *Clean Screen* by toggling the small square in the extreme lower-right corner of the screen, by toggling the Ctrl+0 (Ctrl and zero) key sequence, or by entering the *Cleanscreenon* and *Cleanscreenoff* commands.

FIGURE 1-34

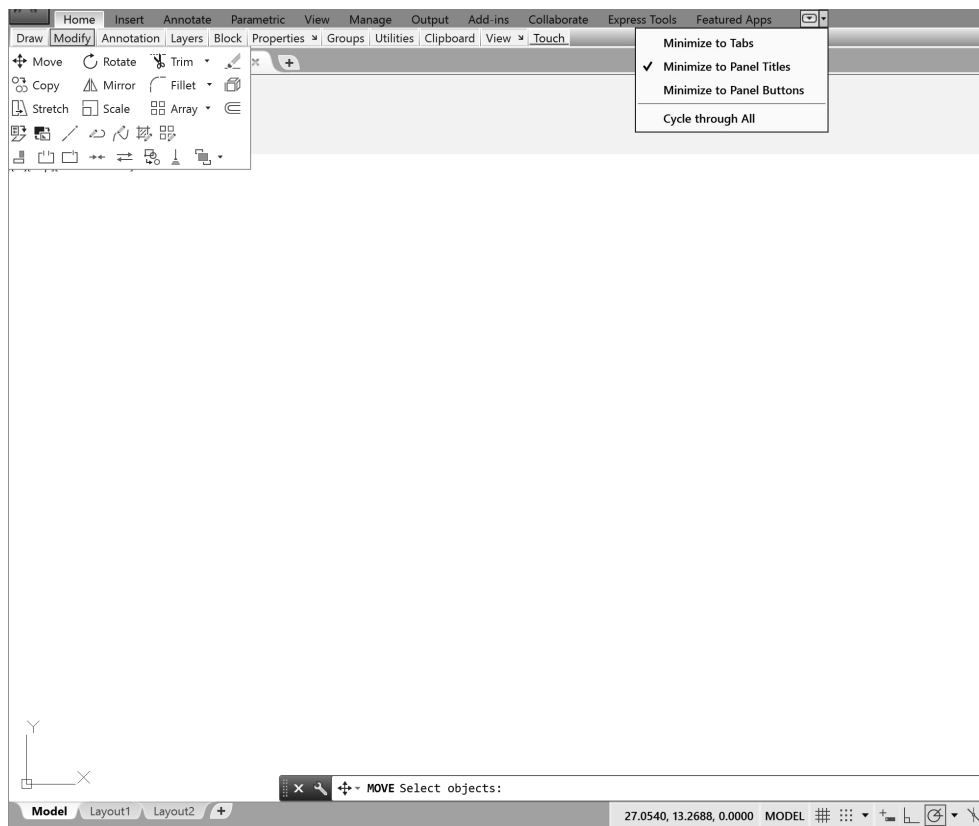
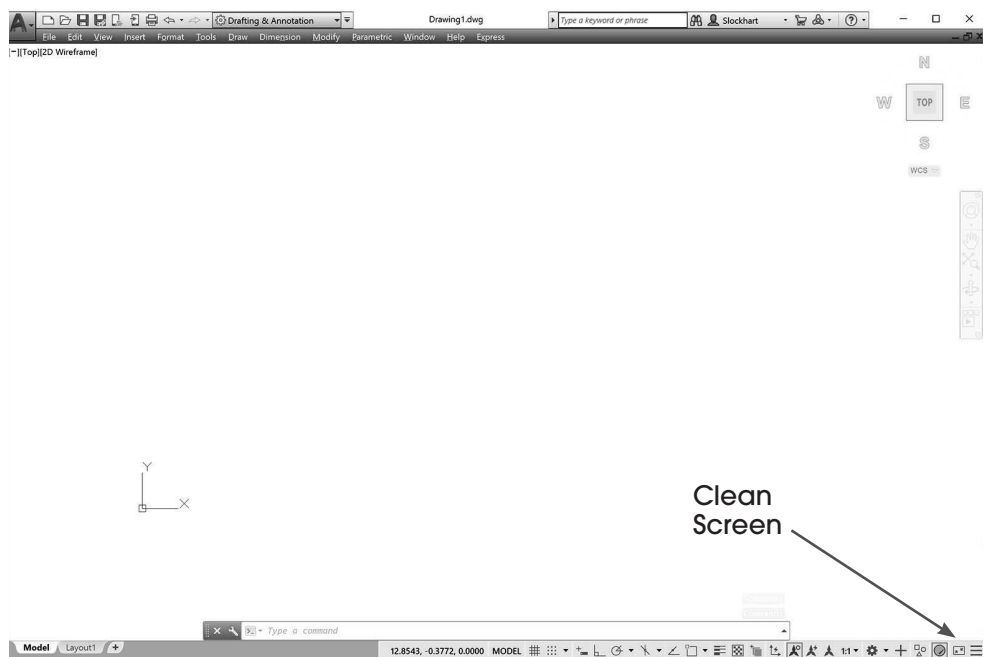

FIGURE 1-35



Options

Fonts, colors, and other features of the AutoCAD drawing editor can be customized to your liking by using the *Options* command and selecting the *Display* tab. Typing *Options* or selecting *Options...* from the *Tools* pull-down menu or default shortcut menu activates the dialog box shown in Figure 1-36. Selecting the *Color...* tile provides a dialog box for customizing the screen colors.

NOTE: All changes made to the Windows screen by any of the options discussed in this section are automatically saved for the next drawing session. The changes are saved as the current profile. However, if you are working in a school laboratory, it is possible that the computer systems are set up to present the same screen defaults each time you start AutoCAD.

FIGURE 1-36

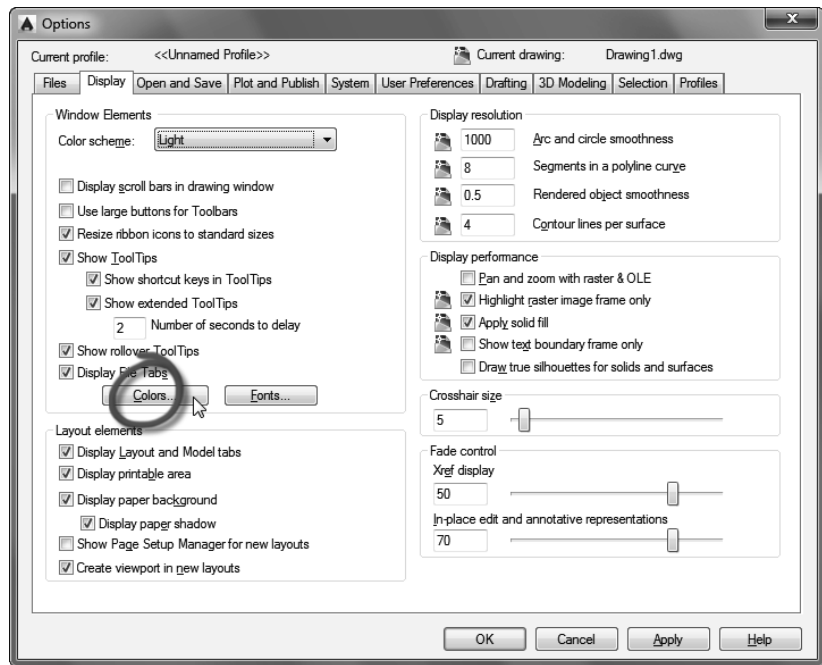

CHAPTER EXERCISES

1. Starting and Exiting AutoCAD

Start AutoCAD by double-clicking the “**AutoCAD 2021**” shortcut icon or selecting “**AutoCAD 2021**” from the Start menu. Select *Start Drawing* in the opening AutoCAD screen. Draw a *Line*. Exit AutoCAD by selecting the *Exit Autodesk AutoCAD 2021* option from the Application Menu (“A” in the upper-left corner). Answer *No* to the “Save changes to Drawing1.dwg?” prompt. Repeat these steps until you are confident with the procedure.

2. Using Drawing Aids

Start AutoCAD. Turn on and off each of the following modes:

Snap, Grid, Ortho, Polar Tracking

3. Understanding Coordinates

Use the Status Bar *Customize* button (lower-right corner) to turn on the display of *Coordinates* and the *Dynamic Input* icon. Start the *Line* command. Begin drawing a *Line* by PICKing a “Specify first point:”. Toggle *Dynamic Input* on and then toggle *Coordinates* to display the *Relative* and *Absolute* formats (HINT: right-click on the coordinate display to access the format options).

PICK several other points at the “Specify next point or [Undo]:” prompt. Pay particular attention to the coordinate values displayed for each point and visualize the relationship between that point and coordinate 0,0 (absolute Cartesian value) or the last point established and the distance and angle (relative polar value). Finish the command by pressing Enter.

4. Using the Text Window

Use the Text Window (F2) to display the text window and the graphics screen.

5. Drawing with Drawing Aids

Draw four *Lines* using each Drawing Aid: *Grid*, *Snap*, *Ortho*, *Polar Tracking*. Toggle on and off each of the drawing aids one at a time for each set of four Lines. Next, draw *Lines* using combinations of the Drawing Aids, particularly *Grid + Snap* and *Grid + Snap + Polar Tracking*.