

ELISE MOSS  
Autodesk Certified Instructor

Autodesk®

# AutoCAD® 2023 Fundamentals

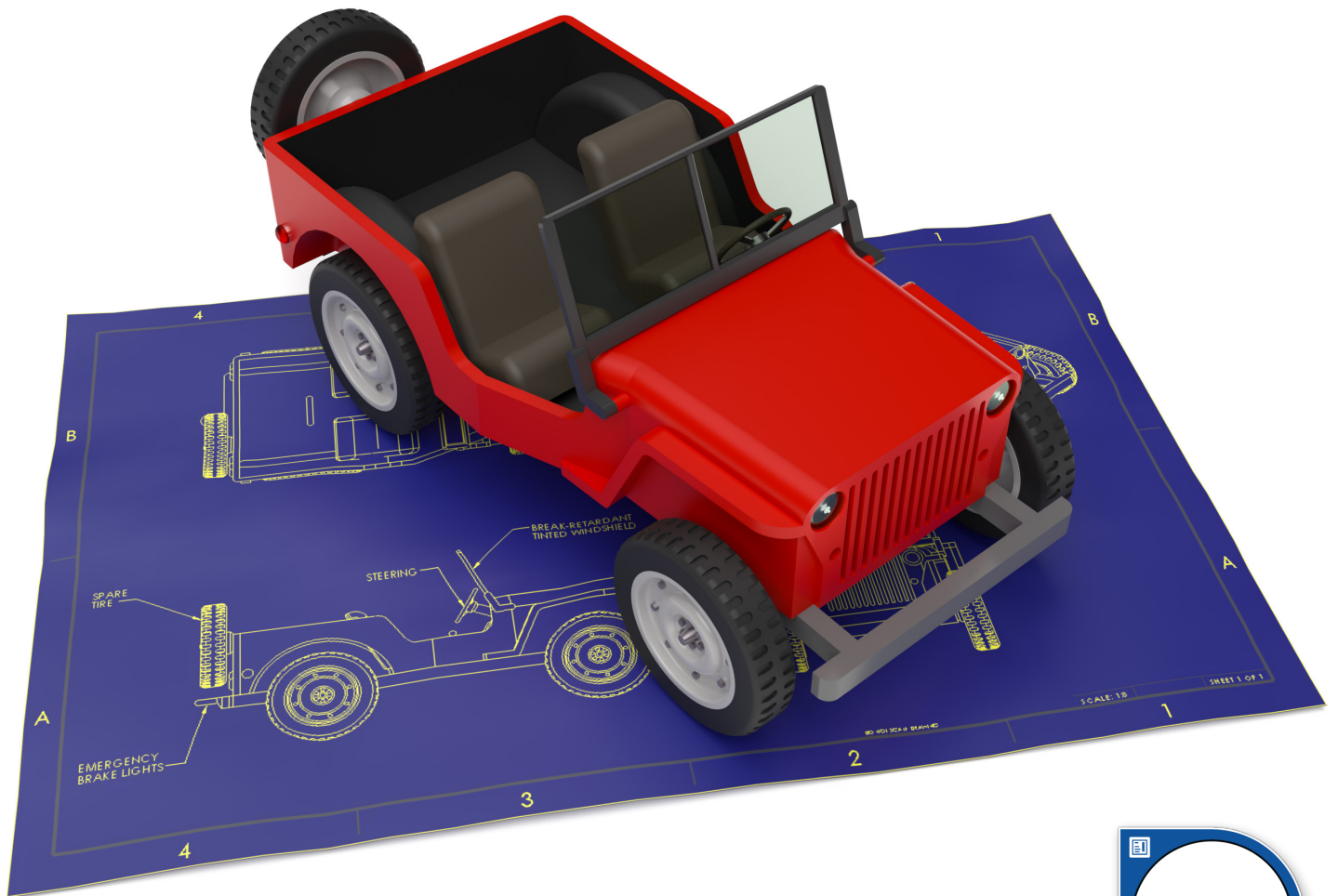

Visit the following websites to learn more about this book:



[amazon.com](https://www.amazon.com)

[Google books](https://books.google.com)

[BARNES & NOBLE](https://www.barnesandnoble.com)

---

## Lesson 3.0 – Drawing Lines

Estimated Class Time: 2 Hours

---

### Objectives

This section introduces AutoCAD commands for creating a simple drawing. Starting with a New drawing, the user will learn to draw lines using different methods.

- **Start From Scratch**
  - Use the New command to begin a new drawing from “scratch.”
- **Line**
  - Draw line segments
  - Using Direct Distance Method
  - Using Polar Tracking
  - Using Cartesian Coordinates
  - Absolute Coordinates
  - Relative Coordinates
  - Polar Coordinates
  - Drag Method
- **Coordinate Entry**
- **Erase**
  - Deleting AutoCAD entities
- **Constraints**
  - Managing Geometric Constraints



- 
- Move the mouse after selecting each endpoint of the line. This will make it easier to see the last line segment created.
  - Double click on ORTHO in the Status Bar (or press F8) to alternate between drawing straight or angled line segments.
  - Typing U for Undo in the middle of the line command will undo the last line segment. Typing U after completing line segments (at the blank command prompt) will Undo the entire line command.
-

## Start a New Drawing

### Command Locator

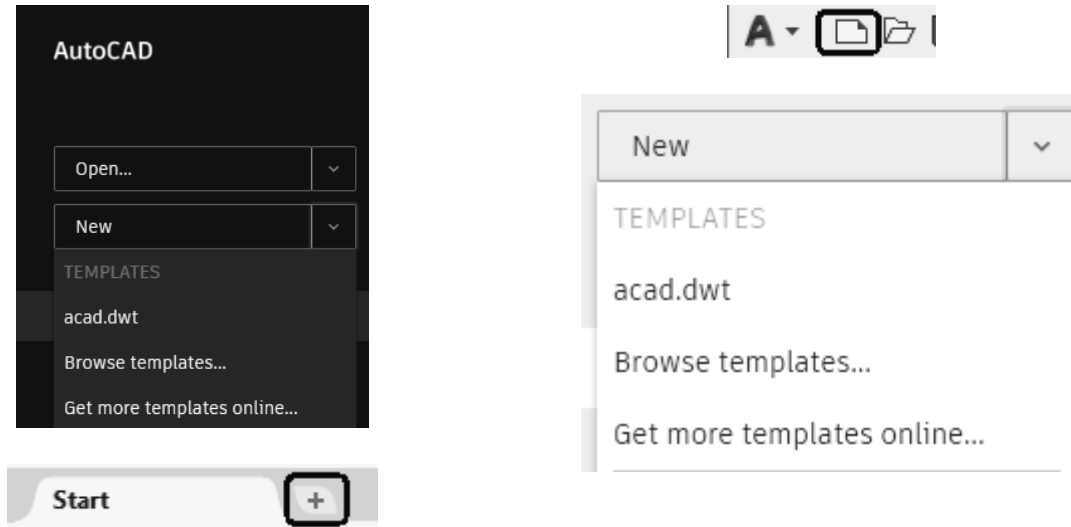

<i>Command</i>	<b>New</b>
<i>Alias</i>	<b>Ctrl+N</b>
<i>Quick Access Toolbar</i>	<b>New</b>
<i>Application Menu</i>	<b>New</b>
<i>Start Tab</i>	<b>New</b>
<i>Folder tab</i>	<b>Click the + tab</b>

For the exercises in this section, we will be using the *acad.dwt* template. This template setting was made when AutoCAD was installed. If you want to set a different default template to be used, go to the **Options** dialog and select the default template you wish to use.

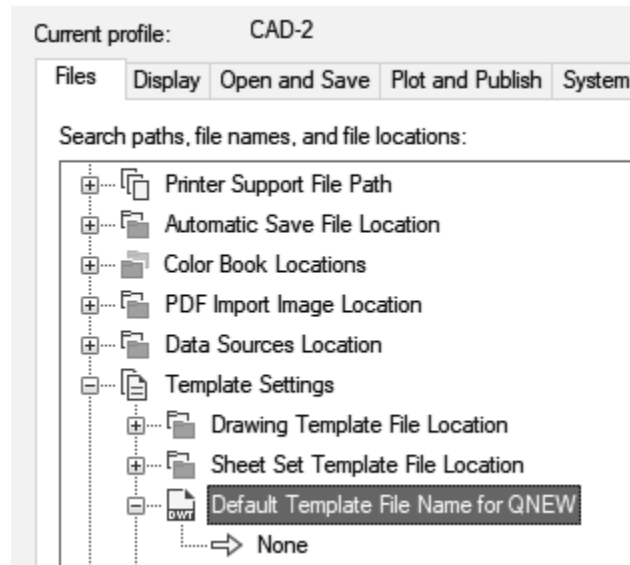

### Command Overview

To Create a New drawing, choose New. Every time the New drawing command is invoked, a new drawing is created with the title Drawing1, Drawing2, Drawing3, etc.

### General Procedures

1. Select the New button from the Standard Toolbar.



- Make it a habit to select the New file icon from the Quick Access Toolbar. This is a quicker way to access the command than from the Applications menu.
- Close drawings that are not being used.
- If you see an asterisk\* next to the file name on the tab, it means there are unsaved changes.

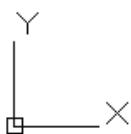
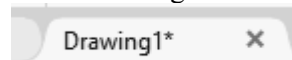

The graphics window uses a Cartesian coordinate system. The lower left corner of the screen shows a UCS (user coordinate system) icon. The icon shows x for horizontal and y for vertical. The z-axis is pointed toward the user. The UCS is located at the 0,0 or origin point.

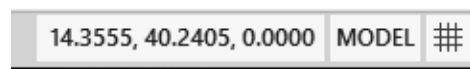

You will see some numbers on the status bar. These numbers reflect the coordinate point (x, y) of your mouse. Move your mouse around and note how the coordinate values change.



- 
- To toggle the display of coordinates on the status bar, left click on the Customize tool in the lower left of the screen and left click on Coordinates in the list.
- 



Your graphics window in AutoCAD emulates a piece of paper. LIMITS controls the size of your piece of paper. When you start a new file, you can specify the size of paper you want to draw on using Wizards or Templates. AutoCAD really doesn't care where you draw in your graphics window. You can draw outside the limits with impunity.

AutoCAD allows you to draw geometry using four methods:

- **Absolute Coordinates**
- **Relative Coordinates**
- **Polar Coordinates**
- **Direct Entry**

Absolute Coordinates use absolute values relative to the origin.

Relative Coordinates use coordinates relative to the last point selected.

Polar Coordinates use a distance and angle relative to the last point selected.

Direct Entry allows the user to set ORTHO on (this is like using a ruler to draw a straight line), move the mouse in the desired direction, and then enter in the desired distance.

## Line

### Command Locator

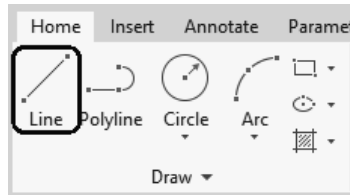

<i>Command</i>	<b>Line</b>
<i>Alias</i>	<b>L</b>
<i>Home/Draw</i>	<b>Line</b>

### Command Overview

A line is defined by two endpoints. A line has 0 width and 0 thickness. When drawing a line, specify the first point, then specify the next point. Press the enter button on the mouse (with the cursor in the drawing window) to access the Line Shortcut menu. Type C to close two or more line segments. Use the LMB to pick the points.

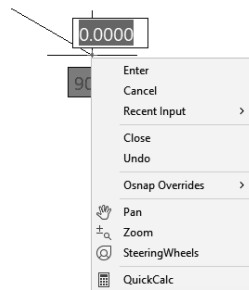

<b>Line Shortcut Menu Option:</b>	<b>Overview</b>
<b>Enter</b>	Select to exit the Line command.
<b>Cancel</b>	Cancel the command.
<b>Recent Input</b>	Lists the most recently entered point coordinates.
<b>Close</b>	Closes the line to form a closed polygon.
<b>Undo</b>	Undoes the last segment of the line.
<b>OSnap Overrides</b>	Allows the user to select an object snap.
<b>Pan</b>	Begins Real-Time Pan.
<b>Zoom</b>	Begins Real-Time Zoom.
<b>Steering Wheels</b>	Launches the Steering Wheel control.
<b>QuickCalc</b>	Launches a calculator.

## **General Procedures**

1. Begin the line command by selecting the line icon in the Draw panel on the ribbon or typing L at the blank command prompt.
2. Select the first point, select the next point, and continue selecting the endpoints of each successive line segment.
3. Press the <ENTER> button on the mouse (with the cursor in the drawing window), then select <ENTER> to end the Line command.
4. Press <ENTER> to Repeat the Line command.



- 
- If you make an error selecting a point, right click and select Undo.
  - If you escape out of a line and want to start at the point where you left off, start the LINE command and then press ENTER – the line will automatically start at the last end point selected.
-



## Command Exercise

### *Exercise 3-1 – Line using Direct Distance Method*

Drawing Name: **Begin a new drawing**  
 Estimated Time to Completion: 10 Minutes

#### Scope

*Start a New drawing. Enable DYN. With ORTHO on, draw the object below. Drag the line in the desired direction and type the distance. Do not add the dimensions.*

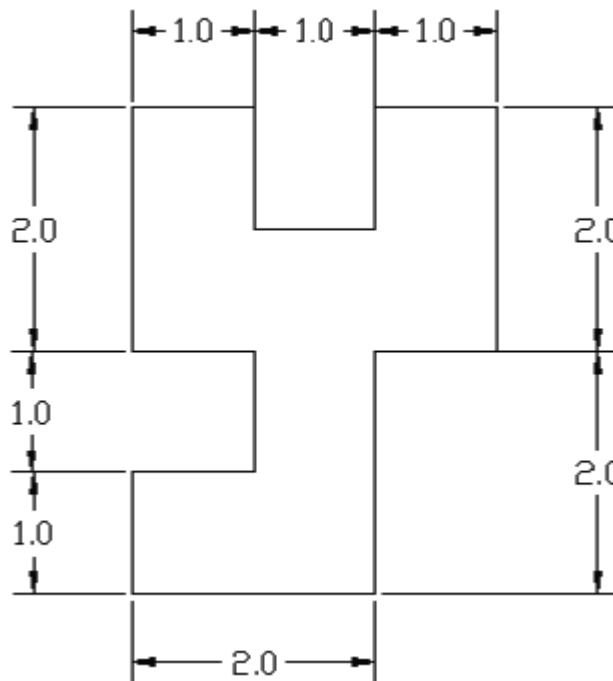

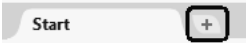
1.  Start a New drawing by pressing the + tab.

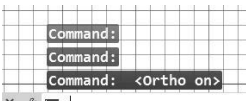
2.  Turn **ORTHO** on by pressing <F8> until the command line says '<Ortho on>'.

3.  To see the geometric constraints as they are added, enable **Infer Constraints** or press **Ctrl+Shift+I**.

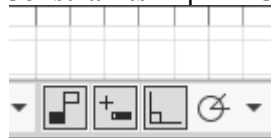

4. Invoke the **Line** command (l or line) on the Home ribbon.

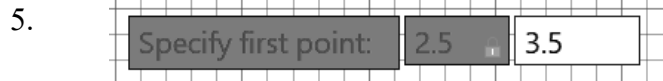
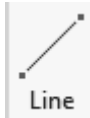

*Specify next point or [Undo]:*  
Type **2.5** for the X-coordinate.  
*Use the TAB key to advance to the Y-coordinate square.*  
Type **3.5** for the Y-coordinate. Press **<ENTER>**.

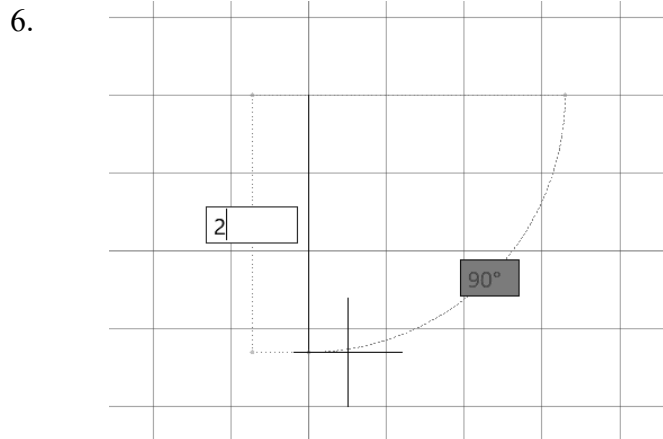

*Specify next point or [Undo]:*  
Drag the cursor downward and type **2.00** and press **<ENTER>**.



*You will see a small icon next to the line. This is a geometric constraint.*

*A geometric constraint controls the geometry of an element. In this case, the symbol indicates that the line is vertical.*

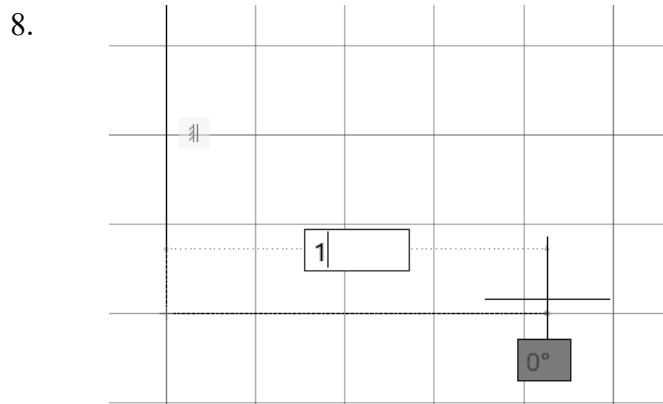

*Specify next point or [Undo]:*  
Drag the cursor to the right and type **1.00** and press **<ENTER>**.



*You should see another geometric constraint. This symbol indicates that the two lines are perpendicular to each other. Perpendicular means two lines form a 90° angle.*

9.

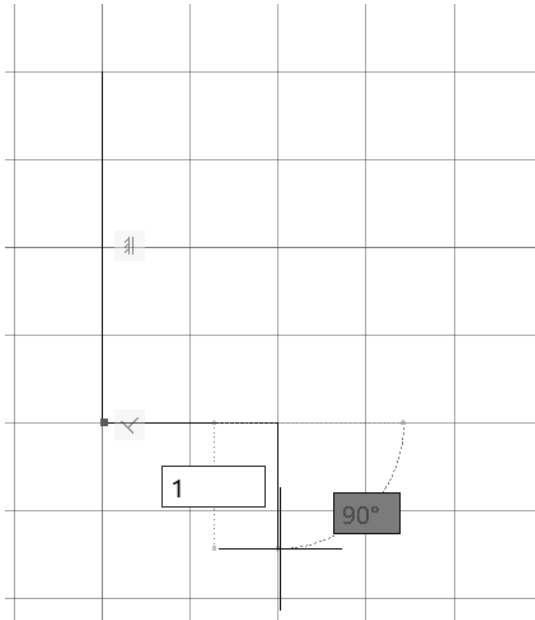

*Specify next point or [Close/Undo]:*  
 Drag the cursor downward and type **1.00** and press <ENTER>.

*Another perpendicular symbol is added.*

10.

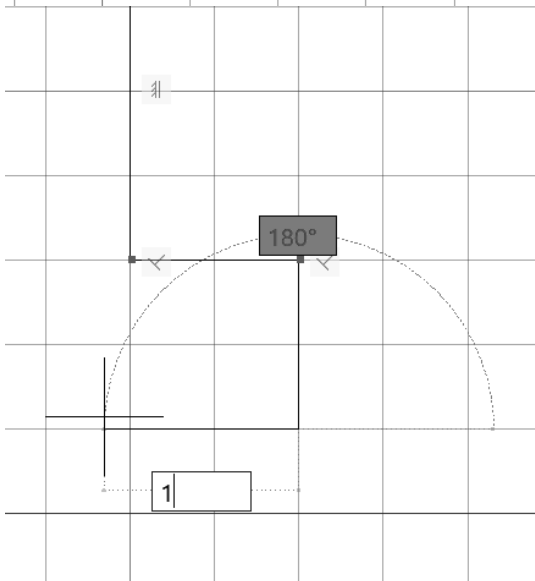

*Specify next point or [Close/Undo]:*  
 Drag the cursor to the left and type **1.00** and press <ENTER>.

11.

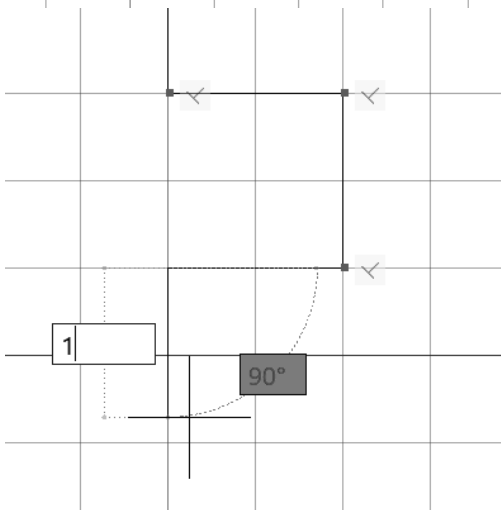

*Specify next point or [Close/Undo]:*  
 Drag the cursor downward and type **1.00** and press <ENTER>.

12.

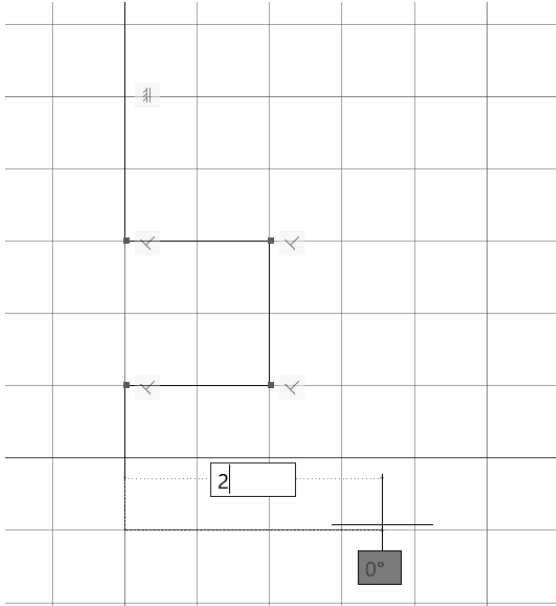

*Specify next point or [Close/Undo]:*  
Drag the cursor to the right and type **2.00** and press <ENTER>.

13.

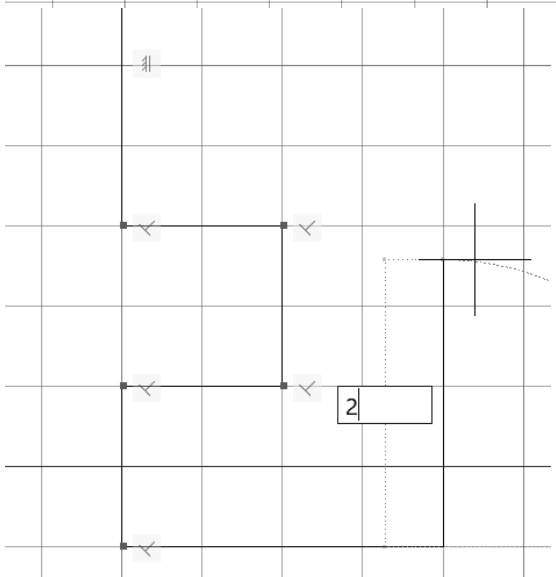

*Specify next point or [Close/Undo]:*  
Drag the cursor up and type **2.00** and press <ENTER>.

14.

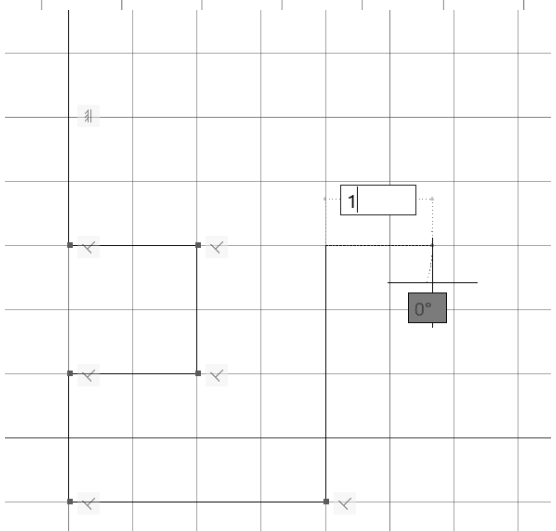

*Specify next point or [Close/Undo]:*  
Drag the cursor to the right and type **1.00** and press <ENTER>.

15.

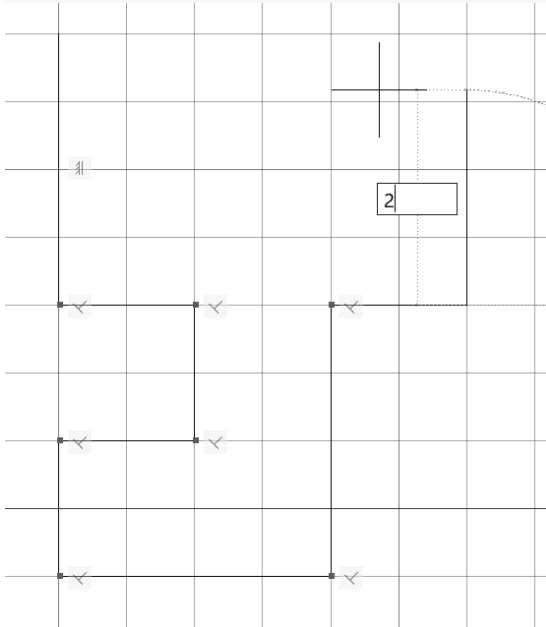

*Specify next point or [Close/Undo]:*  
 Drag the cursor upward and type **2.00**  
 and press <ENTER>.

16.

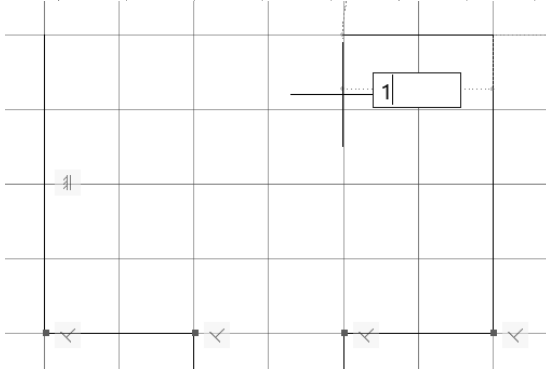

*Specify next point or [Close/Undo]:*  
 Drag the cursor to the left and type **1.00**  
 and press <ENTER>.

17.

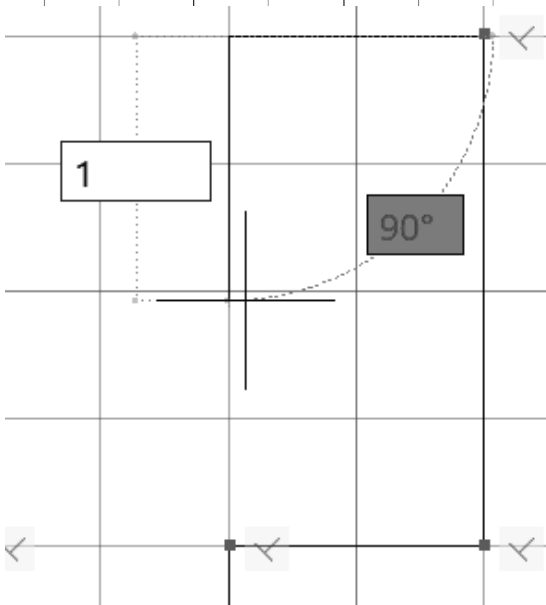

*Specify next point or [Close/Undo]:*  
 Drag the cursor downward and type **1.00**  
 and press <ENTER>.

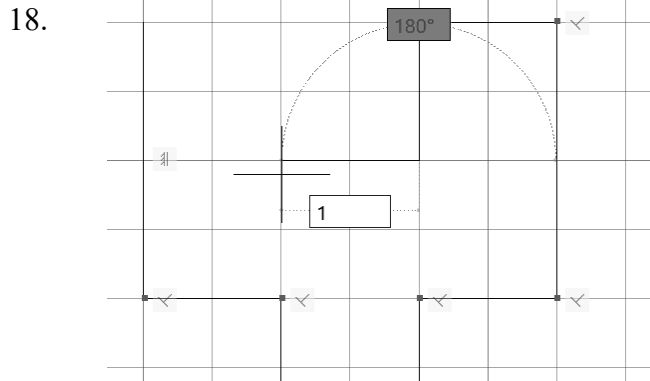

*Specify next point or [Close/Undo]:*  
 Drag the cursor to the left and type **1.00** and press <ENTER>.

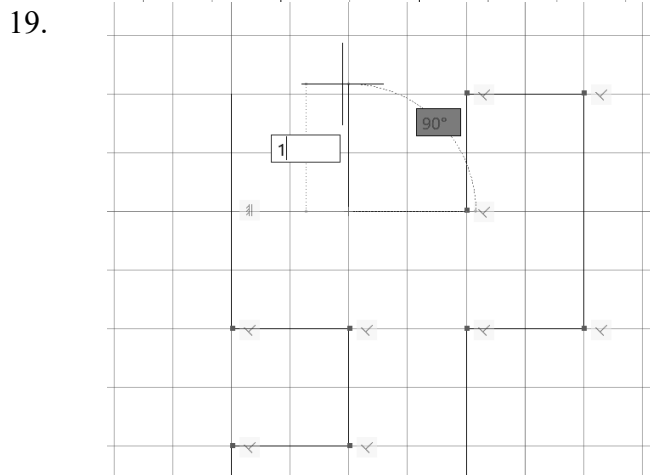

*Specify next point or [Close/Undo]:*  
 Drag the cursor upward and type **1.00** and press <ENTER>.

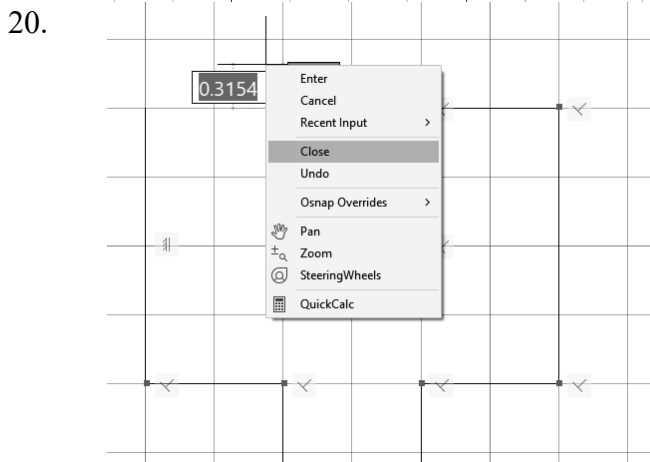

*Specify next point or [Close/Undo]:*  
 Right-click in the drawing area and select 'Close' or type 'C' and press <ENTER>.

*The Close command will only work if you created a continuous line. If you exited the line command and started again, then you have to manually close the figure.*

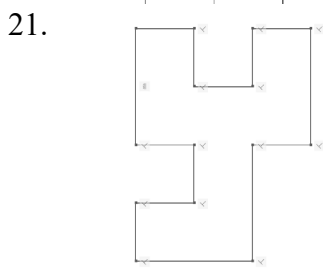

*Your completed figure should look like this.*

*See if you can identify the different geometric constraints. You should see constraint symbols for vertical, horizontal and/or perpendicular.*



To see the figure clearer, turn off the grid.



*If the lines look crooked, then ORTHO is not on. You must begin again. Try to draw all of the line segments without starting and stopping the line command.*

*The Close option only works if you draw in one continuous line. Otherwise, you can simply draw a closing line from endpoint to endpoint.*

## Parametric Constraints

### Command Locator

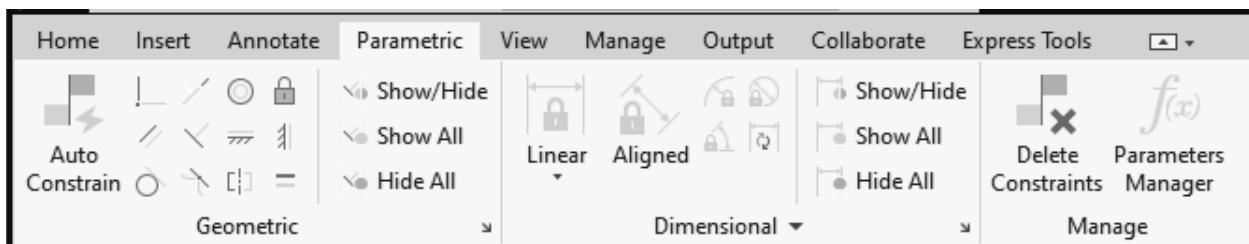

<i>Parametric Ribbon</i>	<b>Parametric</b>
<i>Command</i>	<b>Geomconstraint</b>

### Command Overview

To see the parametric constraints ribbon, you should have the Drafting & Annotation Workspace enabled.

## General Procedures

1. To apply a geometric constraint, select the type of geometric constraint desired, then select the element(s) to be constrained.



- Use inferred constraints - these are constraints which are automatically added as you draw.
- Hide geometric constraints when you are not actively constraining your sketch.
- Typing U for Undo in the middle of the line command will undo the last line segment. Typing U after completing line segments (at the blank command prompt) will Undo the entire line command.
- You can prevent constraints from automatically being applied by toggling OFF inferred constraints on the status bar or using the shortcut Ctl+Shift+I.

## Command Exercise

### Exercise 3-2 – Parametric Constraints

Drawing Name: **constraints1.dwg**

Estimated Time to Completion: 10 Minutes

#### Scope

Open 'constraints1.dwg.' Mouse over a constraint. Show all Constraints. Add a constraint. Delete a constraint. Hide all Constraints.

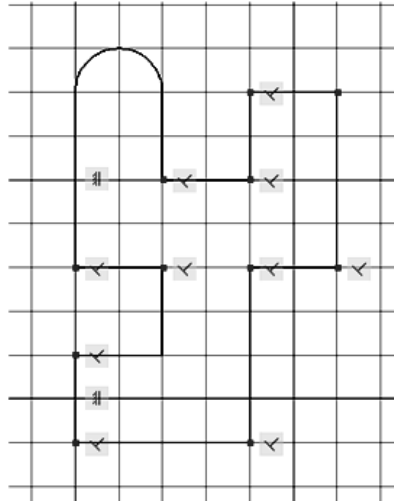

#### Solution

1.

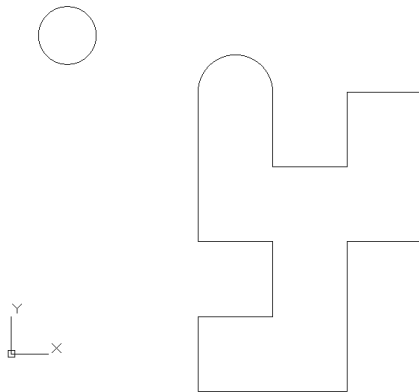



When the drawing is first opened, you should not see any geometric constraints.

The geometric constraints have been hidden. Their display has been turned OFF.

Mouse your cursor over the drawing WITHOUT selecting anything. Don't left click. As you mouse over the lines, you should see a small symbol. The symbol indicates that a geometric constraint exists for that line. If no geometric constraint exists, you will not see the symbol. Mouse over the small circle and notice that no symbol appears.

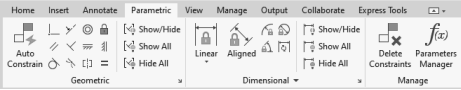

2.  Activate the **Parametric** tab on the ribbon.

3.  Select **Show All** to display all the geometric constraints currently applied.

*Be sure to select from the Geometric panel, not the Dimensional!*

4. Use your left mouse button to rearrange the geometric symbols.  
Hold down the left mouse button and drag the symbol to a new position.

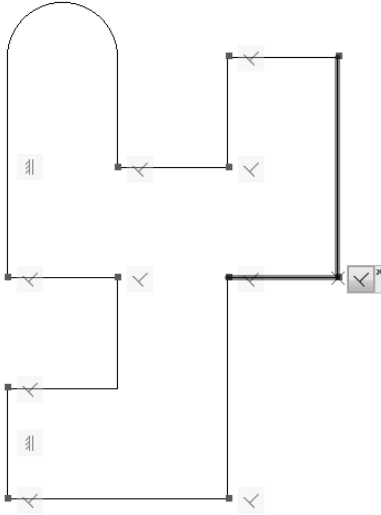

5. Place the left mouse button over one of the perpendicular symbols.

*Notice that it will highlight the two lines that are perpendicular. You do not need to select the symbol. Just hover over it.*

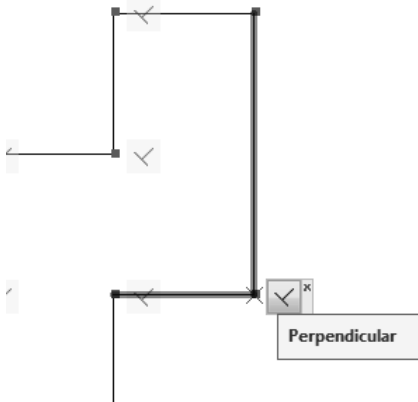

*Let's move the small circle so it is concentric to the arc using a geometric constraint.*

*A concentric constraint means that two or more arcs/circles share the same center point. The elements can have different radii.*

*When you apply a geometric constraint, the FIRST element remains fixed and the SECOND element moves to be constrained.*

6.  Select the **Concentric** constraint.

7.

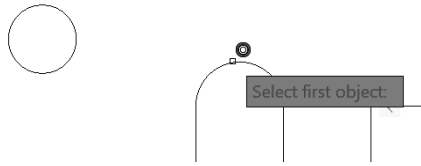

You will see a small Concentric symbol indicating that you are going to be applying that constraint type.

There is a prompt asking you to select the elements to be used for the constraint.

Select the arc first and then the circle.

8.

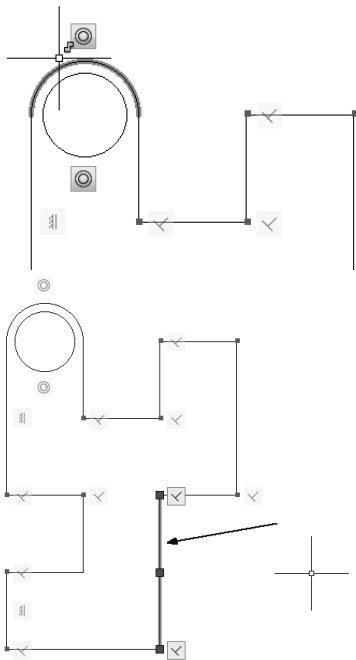

The circle popped into the correct position. You also see the concentric symbol on the arc and the circle.

Select the line indicated.

9.

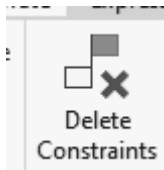

Select **Delete Constraints**.

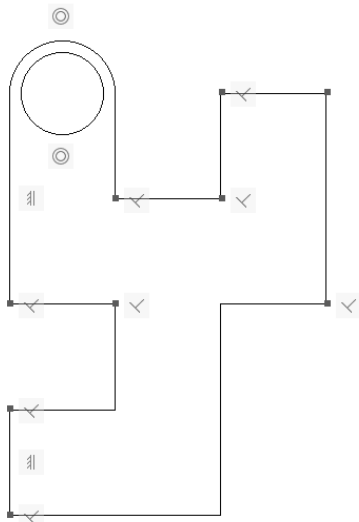

The perpendicular constraints on the selected line are deleted.

10.

Select the same line.

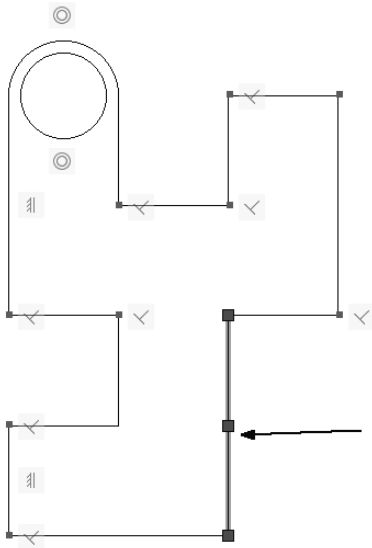

11.

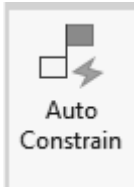

Select **Auto Constrain** from the ribbon.

*This will add constraints to the selected line.  
What constraints do you think will be added?*

A vertical constraint is added.

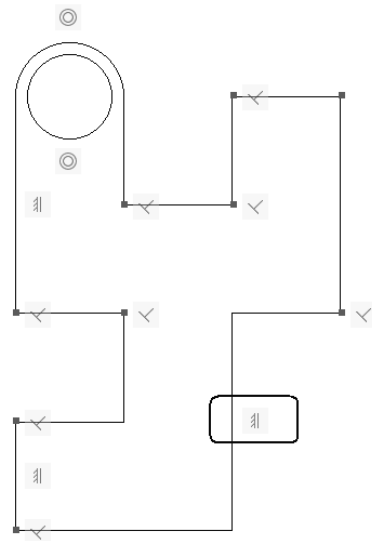

*In order to add a perpendicular constraint - you  
need to select TWO lines.*

12.

Select the vertical constraint.  
Select the small x in the symbol box.

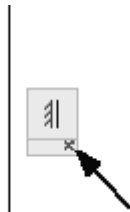

*This hides the constraint.  
It does not delete it.*

13.

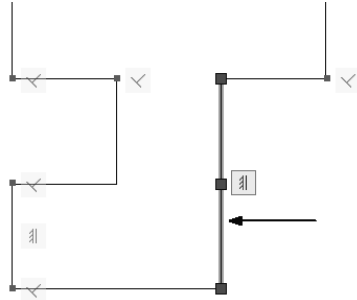

Select the vertical line.

*The vertical symbol will appear while the line is selected.*

14.

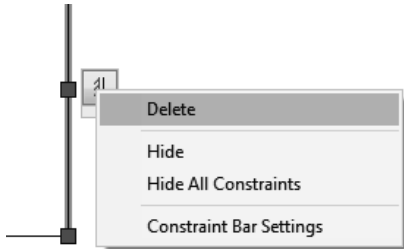

To delete the vertical constraint, select it, right click and select **Delete**.

*Press ESC to release the selection.*

15.

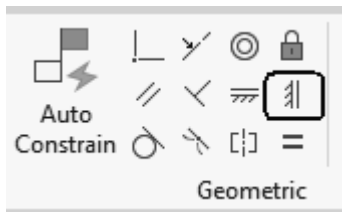

Select the vertical constraint tool on the ribbon.

16.

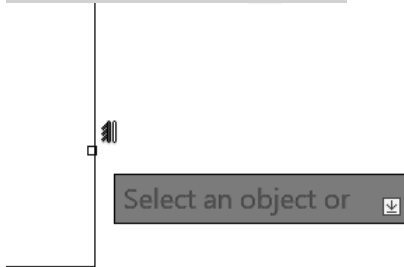

*You will see the Vertical constraint icon and a prompt to select the element where the constraint is to be applied.*

17.

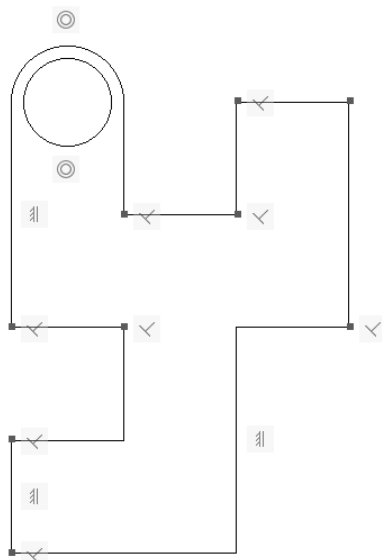

Select the vertical line.

***You can only apply a vertical constraint if the constraint has been removed. Too many geometric constraints on the same element is not allowed.***

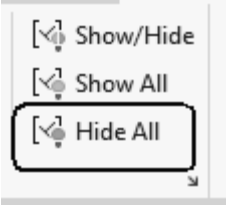
18.  Select **Hide All**.  
*This hides all the geometric constraints.*
19. Close without saving.

---

## **Polar Tracking**

---

Polar tracking restricts cursor movement to specified angles. PolarSnap restricts cursor movement to specified increments along a polar angle.

When you create or modify objects, you can use polar tracking to display temporary alignment paths defined by the polar angles you specify. In 3D views, polar tracking additionally provides an alignment path in the up and down directions. In that case, the tooltip displays a +Z or -Z for the angle.

Polar angles are relative to the orientation of the current user coordinate system (UCS) and the setting for the base angle convention in a drawing, which is set in the Drawing Units dialog box.

Use PolarSnap™ to snap to specified distances along the polar alignment path. For example, in the following illustration you draw a two-unit line from point 1 to point 2, and then draw a two-unit line to point 3 at a 45-degree angle to the line. If you turn on the 45-degree polar angle increment, an alignment path and tooltip are displayed when your cursor crosses the 0 or 45-degree angle. The alignment path and tooltip disappear when you move the cursor away from the angle.

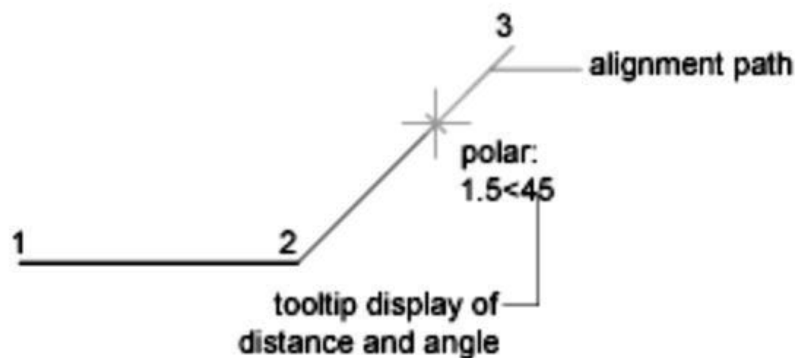

Use polar tracking to track along polar angle increments of 90, 60, 45, 30, 22.5, 18, 15, 10, and 5 degrees, or you can specify different angles. The following illustration shows the alignment paths displayed as you move your cursor 90 degrees with the polar angle increment set to 30 degrees.

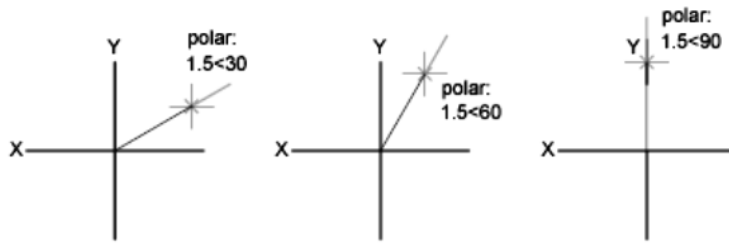

## Command Exercise

### Exercise 3-3 – Line Using Polar Tracking

Drawing Name: **Line2.dwg**

Estimated Time to Completion: 10 Minutes

#### Scope

Open 'line2.dwg' and draw the object shown in the example using the line command with POLAR enabled. Polar settings have already been made to create the necessary angles. When you have completed the third segment, type C to close the object. Press <ENTER> to repeat the line command, press <ENTER> again, and see that the line picks up from the last point selected.

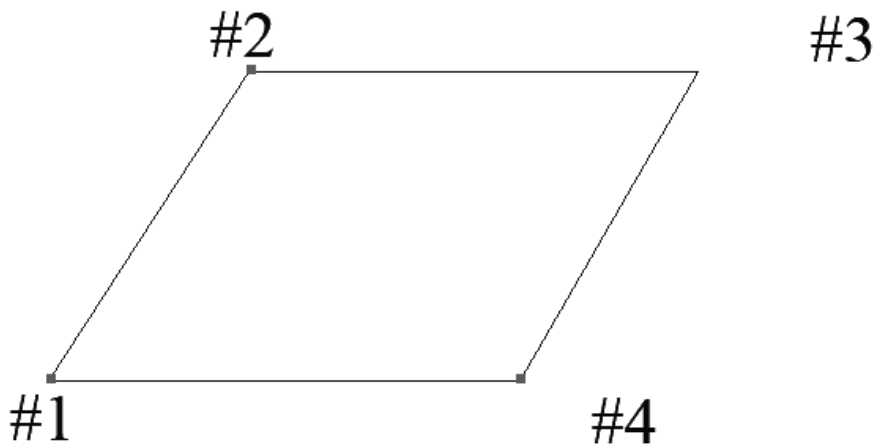

#### Solution

1.



Turn **POLAR TRACKING** on.

2.

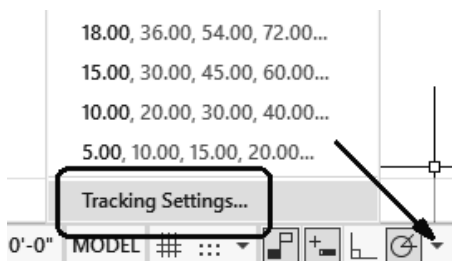

Left click on the down arrow next to the Polar Tracking icon.

Select **Tracking Settings**.

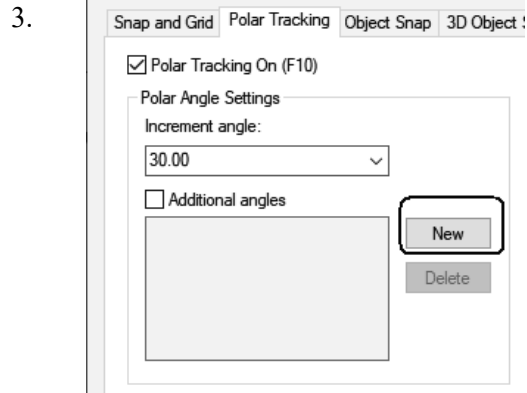

Select the **New** button to add an additional angle setting.

*The increment angle shown may be different depending on your settings.*

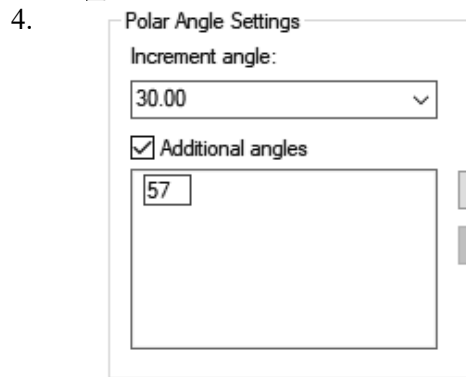

Type in **57.00** for the new angle value.

Click **OK**.

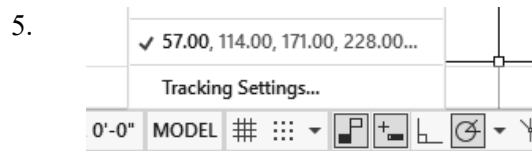

Left click on the down arrow next to the Polar Tracking icon.

Enable the **57.00** polar values.

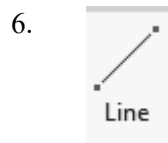

Invoke the **Line** command (l or line) from the Home tab on the ribbon.

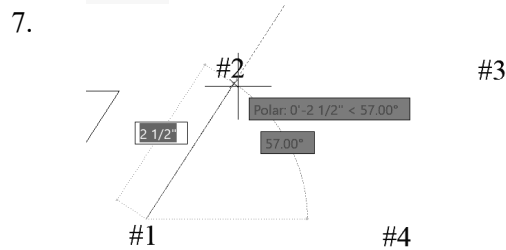

*Specify first point:*

Pick a start point of the line with your left mouse button near the #1 on the drawing.

*Specify next point or [Undo]:*

Pick a second point near the #2 on the drawing.

*As you draw your line up to the #2, look for the Tooltip indicating the 57-degree angle. As you draw your line up to the #3, look for the Tooltip indicating the 0-degree angle.*

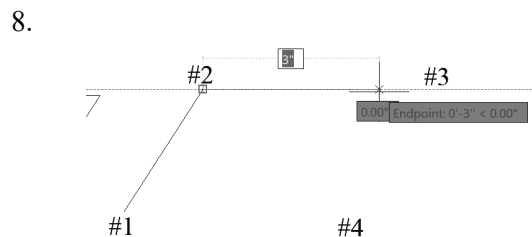

*Specify next point or [Undo]:*

Move your mouse near #3 and click to complete the second line segment.

Press **ESC** to exit the LINE command.



9.

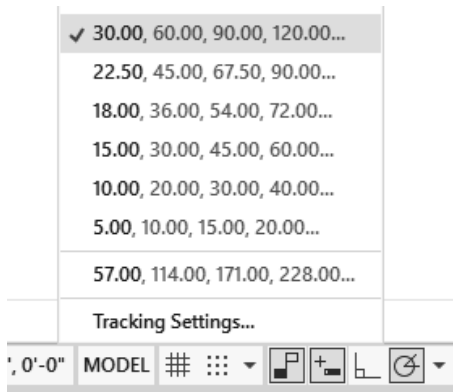

Left click on the down arrow next to the Polar Tracking icon.

Enable the **30.00** polar values.

10.

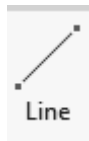

Select the **LINE** tool.

11.

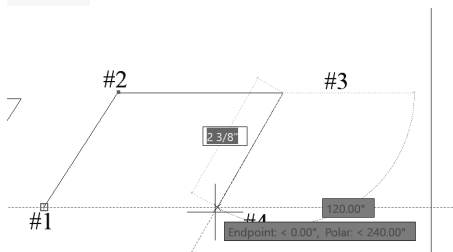

Press **ENTER** and the line will start where you left off at Point #3.

*Specify next point or [Close/Undo]:*

Use Object Tracking to line up your end point and set the Polar Angle to 120-degrees.

12.

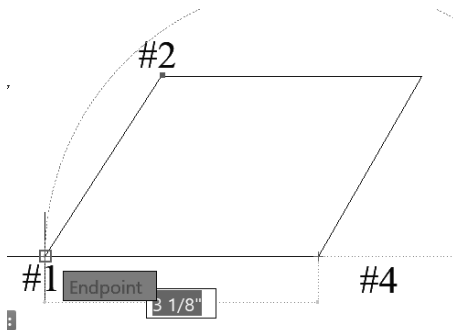

*Specify next point or [Close/Undo]:*

Place the final line segment by selecting the **END**point of the first line near Point #1.

13.

Close without saving.



- When you closed your object did it complete the parallelogram? If not, you may have stopped and restarted the line sequence, in which case the close option will refer to the new start point.
  - Move your mouse as you work to see what line segments you have just completed.
  - Click on ORTHO in the Status bar, or press the <F8> function key, whichever is more convenient at the time to create straight lines.
  - Make a habit of using the <ENTER> key to complete your AutoCAD commands, and to repeat the last command used. Alternately, you may click the right mouse button and select the Repeat option.
  - In order for Polar Tracking to click to specific angle values, you have to have them set. Use Settings in the Polar Tracking dialog to add angles you want to use in your drafting.
- 

---

### **Cartesian Coordinates**

---

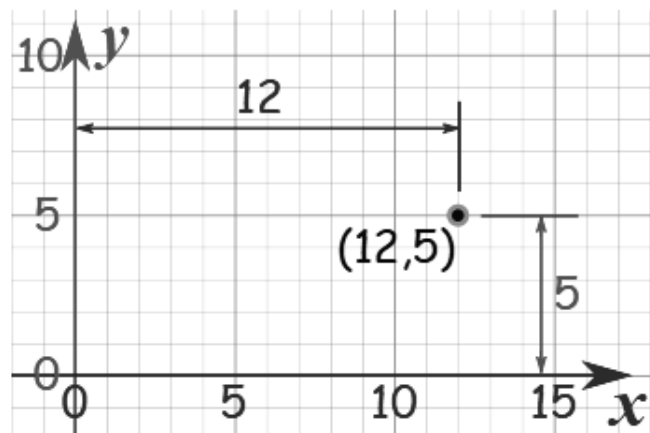

AutoCAD uses a Cartesian coordinate system – where x is the horizontal direction and y is the vertical direction. You can remember the difference between x and y by thinking x is a cross and x is across the page. The positive direction of x is towards the right. The negative direction of x is towards the left. The positive direction of y is up. The negative direction of y is down. Coordinates are always written X, Y with the X value first and the Y value second. So, a coordinate of 3,2 means three units to the right and two units up from the origin.

The status bar displays where the cursor is along the coordinate system. You can enter points using the coordinate system to place lines, circles and other elements. If you are drawing a survey map, the surveyor may provide you with a list of points to use to draw the outline of the building site. Those points are Cartesian coordinates.

There are four basic methods of drawing lines:

- Absolute Coordinates
- Relative Coordinates
- Polar Coordinates
- Drag or Direct Entry Method

Think of your drawing area as a blank piece of paper. The origin is located at 0,0. If you use absolute coordinates, you are selecting points based on their actual value on the grid. If you use relative coordinates, you are entering the distance in the X and Y direction from your current location. If you use polar coordinates, it is similar to a vector—where you enter a length and an angle. Polar coordinates usually use relative coordinates. The drag or direct entry method is the easiest method for most users—simply move your cursor in the direction you want to draw a line and enter in the distance/length of the line.

In order to ensure that you get the results you want, it is important to be cognizant of whether your drafting settings are set to relative or absolute coordinates.

To check your drafting settings, type DSETTINGS or DS.

Select the Dynamic Input tab.

Select the Settings button under Pointer Input.

If you want to use relative coordinates while in absolute coordinate mode, just type an @ before your coordinate entry; i.e. @3,1.



➤ *If your drawing did not turn out properly, make sure you had DYN OFF. To check your data entry, press F2 and the text window will open and you can review your entries.*

## Coordinate Entry

### Command Overview

Once the Units have been established, coordinates can be typed to specify points or distances. Always draw full scale. There are four ways to specify coordinates: absolute, relative, polar, and direct distance.

<b>Coordinate Entry Method</b>	<b>Overview</b>	<b>Examples</b>
<b>Absolute Coordinates</b>	The x and y coordinates are determined by an absolute Origin point of 0,0.	X,Y 1,5
<b>Relative Coordinates</b>	The x and y coordinates reference the last point selected in the drawing.	@x,y @3,5
<b>Polar Coordinates</b>	The distance and angle specified references the last point selected in the drawing.	@distance<angle @5<45
<b>Direct Distance</b>	Select the first point, then drag the cursor in the desired direction and type the distance.	Type the distance 4

## **General Procedures**

### **Using Absolute Coordinates:**

1. When prompted to specify a point, type the Absolute coordinates for x and y (x,y).
2. Type the Absolute Coordinate for each successive point (x,y).  
*Typical Example: Inserting a Title Block or an Externally Referenced Drawing at a specific location.*

### **Using Relative Coordinates:**

1. When prompted to specify a point, select a point in the drawing.
2. Type the Relative Coordinate for each successive point (@x,y).  
*Typical Example: Drawing a Rectangle.*

### **Using Polar Coordinates:**

1. When prompted to specify a point, select a point in the drawing.
2. Type the Polar Coordinate for each successive point (@distance < angle).  
*Typical Example: Drawing lines or moving objects at a specified distance and angle other than orthogonal angles.*

### **Using Direct Distance:**

1. When prompted to specify a point, select a point in the drawing.
2. Turn ORTHO on and drag the cursor in the desired direction.
3. Type the distance and press <ENTER>.  
*Typical Example: Drawing lines or using the Move, Copy or Stretch commands.*



- Always use object snap for selecting specific points in the drawing.
  - Remember to separate the x and y coordinates by a comma. Example: 1,5 means the absolute coordinate where x=1 and y=5.
  - It is not necessary to type the z coordinate when z = 0.
  - Angles are typically measured counterclockwise. Angle 0 is typically East.
  - Precede Relative and Polar coordinate information with an @ sign (over the number 2 on the keyboard) if drafting settings are set to Absolute Coordinates.
  - ORTHO should be on when using the direct distance method.
  - When drawing lines, or moving objects at specific angles (other than with ORTHO on), type the polar coordinate (example: @10<45) or use Polar Tracking Settings.
  - Typing the minimum number of keystrokes is important for drawing efficiently. AutoCAD will fill in leading and trailing zeros and the appropriate Unit endings.
  - AutoCAD will convert decimal equivalents to feet and inches.
  - AutoCAD will assume inches, unless the foot mark ' is typed.
  - The Coordinates Display can be turned on or off from the Status Bar by double clicking on it (LMB). If in the middle of a Draw or Modify command, a third option will display the distance and <angle.
  - The DYN toggle can be used to display and enter coordinates.
  - Use the Drafting Settings dialog to verify the mode of data entry you are using.
-

---

## Command Exercise

### *Exercise 3-4 – Line Using Cartesian Coordinates*

---

Drawing Name: **Begin a new drawing**

Estimated Time to Completion: 10 Minutes

#### Scope

*Start a New Drawing using the acad.dwt template and draw the object shown in the example using the line command with Cartesian Coordinates. When you have completed the third segment, type C to close the object. Press <ENTER> to repeat the line command, press <ENTER> again, and see that the line picks up from the last point selected. Turn DYN off and ORTHO on for this exercise.*

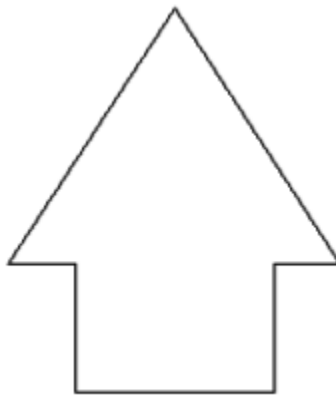

#### Solution

1.  Click the Start tab.

Click **New**→**acad.dwt**.

*This starts a new drawing using the acad.dwt template.*

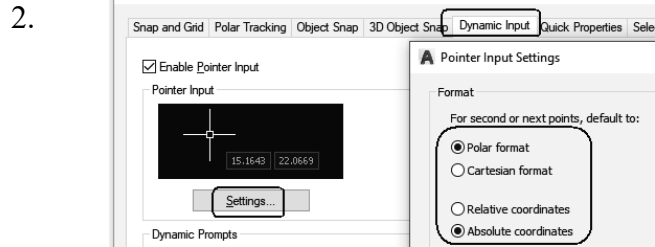

Type **DSETTINGS**.

Select the **Dynamic Input** tab.  
Click **Settings** under Pointer Input.  
Enable **Absolute Coordinates**.  
Click **OK** twice to close the dialog boxes.

3. Invoke the **Line** command (l or line).

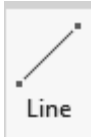

*Specify first point:* Type **0,0** at the command line.



*Specify next point or [Undo]:* Type **3,0**.



*Specify next point or [Undo]:* **3,2**



*Specify next point or [Close/Undo]:* **4,2**

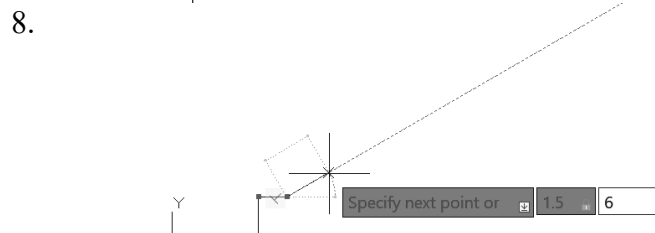

*Specify next point or [Close/Undo]:* **1.5,6**

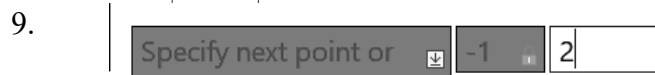

*Specify next point or [Close/Undo]:* **-1,2**

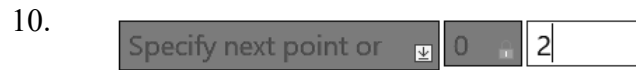

*Specify next point or [Close/Undo]:* **0,2**

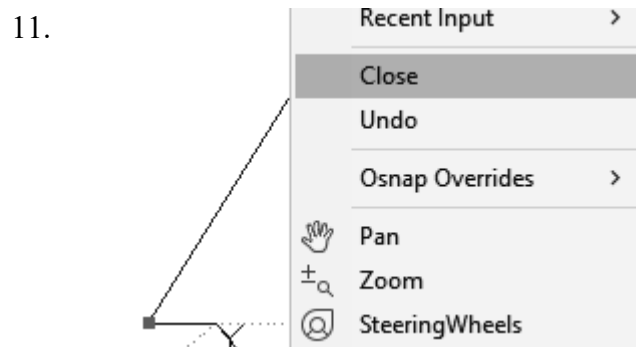

*Specify next point or [Close/Undo]:*  
Right-click in the drawing area and select 'Close' or type 'C' or 'CLOSE' and press <ENTER> at the command line to create the final line segment.  
*You can press U for UNDO if you make an error on any of the lines and restart. If you didn't make a continuous line, you can't use the CLOSE command. Type 0,0 instead.*

## Command Exercise

### Exercise 3-5 – Absolute Coordinates

Drawing Name: **entry1.dwg**

Estimated Time to Completion: 10 Minutes

#### Scope

Start the line command. Draw the objects using the absolute coordinates in the order indicated. Connect the points using only the keyboard. Turn DYN off and ORTHO on.

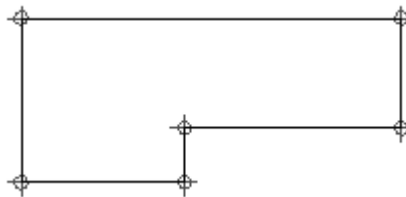

#### Solution

Before you start this exercise, you need to have your drafting settings set up to use absolute coordinates.

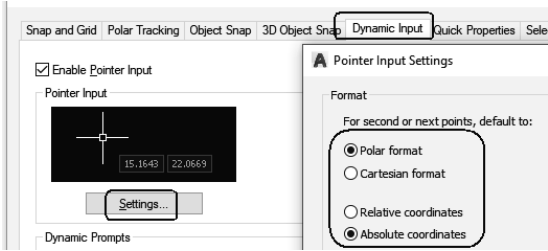
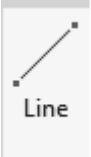
1.  Type **DSETTINGS**.  
Select the **Dynamic Input** tab. Click **Settings** under Pointer Input. Enable **Absolute Coordinates**. Click **OK** twice to close the dialog boxes.
2.  Invoke the **Line** command (l or line).
3. *Specify first point:*  
Type **1,1** at the command line and press <ENTER>. Notice where the first point of the line is created.
4. *Specify next point or [Undo]:*  
Type **4,1** at the command line and press <ENTER>.
5. *Specify next point or [Undo]:*  
Type **4,2** at the command line and press <ENTER>.
6. *Specify next point or [Close/Undo]:*  
Type **8,2** and press <ENTER>.
7. *Specify next point or [Close/Undo]:*  
Type **8,4** and press <ENTER>.

8. *Specify next point or [Close/Undo]:*  
Type **1,4** and press <ENTER>.
9. *Specify next point or [Close/Undo]:*  
Type **1,1** and press <ENTER>.
10. *Specify next point or [Close/Undo]:*  
Press the <ENTER> key to end the command.



➤ *You can also use the close option to complete the exercise rather than typing in the final '1,1'.*

---



---

## Command Exercise

### Exercise 3-6 – Relative Coordinates

---

Drawing Name: **entry2.dwg**

Estimated Time to Completion: 10 Minutes

#### Scope

Start the line command. Draw the objects using the relative coordinates in the order indicated. Connect the points using only the keyboard. Turn *DYN* off and *ORTHO* on.

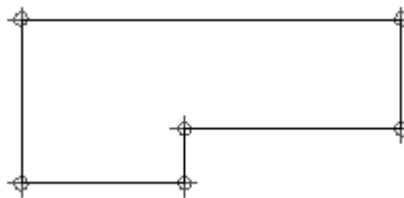

#### Solution

Before you start this exercise, you need to have your drafting settings set up to use relative coordinates.

1.

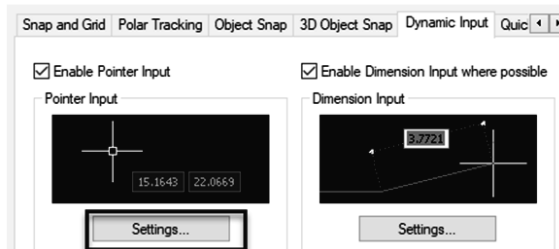

Type **DSETTINGS**.

Select the **Dynamic Input** tab. Click **Settings** under Pointer Input.

2.

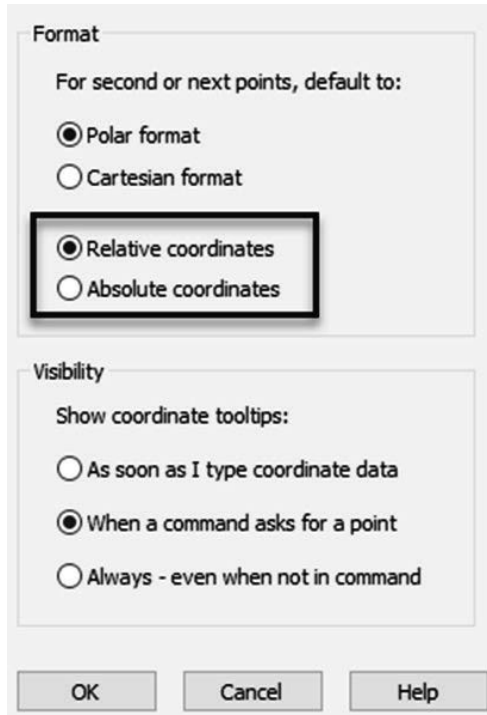

Enable **Relative Coordinates**.  
Click **OK** twice to close the  
dialog boxes.

3.

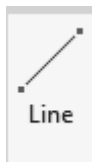

Invoke the **Line** command (l or line).

4.

*Specify first point:*

Type **1,1** at the command line and press <ENTER>. Notice where the first point of the line is created.

5.

*Specify next point or [Undo]:*

Type **3,0** at the command line and press <ENTER>.

6.

*Specify next point or [Undo]:*

Type **0,1** at the command line and press <ENTER>.

7.

*Specify next point or [Close/Undo]:*

Type **4,0** and press <ENTER>.

8.

*Specify next point or [Close/Undo]:*

Type **0,2** and press <ENTER>.

9.

*Specify next point or [Close/Undo]:*

Type **-7,0** and press <ENTER>.

10.

*Specify next point or [Close/Undo]:*

Type **0,-3** and press <ENTER>.

11.

*Specify next point or [Close/Undo]:*

Press the <ENTER> key to end the command.

Notice that absolute coordinates use the absolute values of X and Y. Relative coordinates tell AutoCAD how many units to move in the X or Y direction from the current location of the cursor.

***Extra:** What would you type in to create the shape in a clockwise fashion instead of counterclockwise direction? Try it.*

## Command Exercise

### Exercise 3-7 – Polar Coordinates

Drawing Name: **entry3.dwg**

Estimated Time to Completion: 5 Minutes

#### Scope

Start the line command. Draw the objects using polar coordinates in the order indicated. Connect the points using only the keyboard.

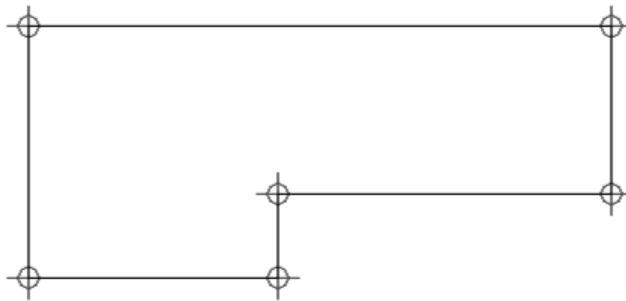

By using the @ symbol before the first number, you are specifying a relative coordinate. The < symbol indicates the angle to be used.

#### Solution

1.

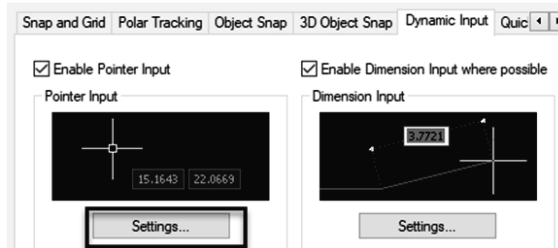

Type **DSETTINGS**.

Select the **Dynamic Input** tab.  
Click **Settings** under Pointer Input.

2.

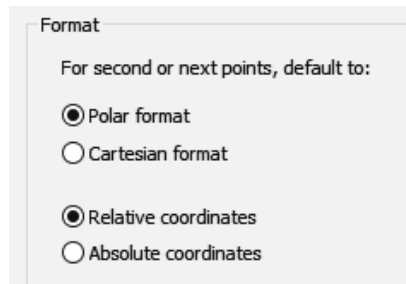

Enable **Relative Coordinates**.

Click **OK** twice to close the dialog boxes.

3. Invoke the **Line** command (l or line).

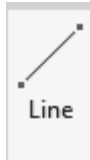

4. *Specify first point:*  
Type **1,1** at the command line and press <ENTER>. Notice where the first point of the line is created.
5. *Specify next point or [Undo]:*  
Type **@3<0** at the command line and press <ENTER>.
6. *Specify next point or [Undo]:*  
Type **@1<90** at the command line and press <ENTER>.
7. *Specify next point or [Close/Undo]:*  
Type **@4<0** and press <ENTER>.
8. *Specify next point or [Close/Undo]:*  
Type **@2<90** and press <ENTER>.
9. *Specify next point or [Close/Undo]:*  
Type **@7<180** and press <ENTER>
10. *Specify next point or [Close/Undo]:*  
Type **@3<270** and press <ENTER>.
11. *Specify next point or [Close/Undo]:*  
Press the <ENTER> key to end the command.

////////////////////////////////////  
**Extra:** What would happen if you typed @-3<180 in step 3 in the exercise? Try it.  
 //////////////////////////////////////

---

## Command Exercise

### Exercise 3-8 – Drag Method

---

Drawing Name: **entry4.dwg**



Estimated Time to Completion: 5 Minutes

#### Scope

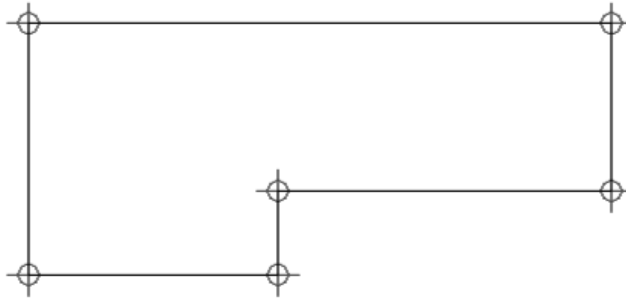
Start the line command. Draw the objects using the direct entry method.

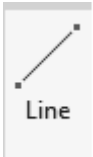

#### Solution

1.  Invoke the **Line** command (l or line).
2. *Specify first point:*  
Type **1,1** at the command line and press <ENTER>. Notice where the first point of the line is created.
3.  *Specify next point or [Undo]:*  
Toggle ORTHO ON at the Status bar.
4. *Specify next point or [Undo]:*  
Drag the mouse to the right, type **3** and press <ENTER>.
5. *Specify next point or [Close/Undo]:*  
Drag the mouse upward, type **1** and press <ENTER>.
6. *Specify next point or [Close/Undo]:*  
Drag the mouse to the right, type **4** and press <ENTER>.
7. *Specify next point or [Close/Undo]:*  
Drag the mouse upward, type **2** and press <ENTER>.
8. *Specify next point or [Close/Undo]:*  
Drag the mouse to the left, type **7** and press <ENTER>.
9. *Specify next point or [Close/Undo]:*  
Drag the mouse downward, type **3** and press <ENTER>.

10. *Specify next point or [Close/Undo]:*  
 Press the <ENTER> key to end the command.

## Erase

### Command Locator

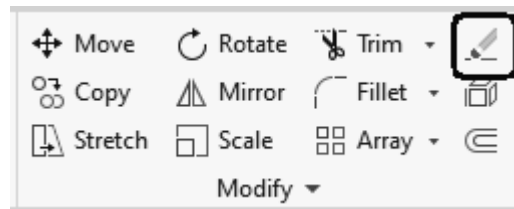

<i>Home/Modify Panel</i>	<b>Erase</b>
<i>Command</i>	<b>Erase</b>
<i>Alias</i>	<b>E</b>

### Command Overview

Erase deletes selected objects. Press <ENTER> after selecting the objects to erase to execute the command. Type OOPS to bring back the last set of erased objects, even if other objects were drawn since the last erase.

### General Procedures

1. Begin the erase command by selecting the Erase icon from the Modify Toolbar/Ribbon or typing E at the blank command prompt.
2. Place the cursor over the objects to erase and pick (LMB).



- If the cursor is not over an object, a selection window will appear. Make the other corner of the selection window.
- A Selection Window made from Left to Right will select only the objects completely in the window. *This is called a selection window.*
- A Selection Window made from Right to Left will select all objects the window crosses. *This is called a selection crossing.*
- Typing All (and pressing <ENTER>) will select all objects in the drawing to erase. Press <ENTER> to execute the command.

---

## Command Exercise

### *Exercise 3-9 – Erase*

---

Drawing Name: **erase1.dwg**

Estimated Time to Completion: 5 Minutes

#### Scope

*Erase the objects in the drawing. Draw some more lines. Type OOPS to bring back the last set of erased objects. OOPS is different from UNDO. UNDO backs up the last set of issued commands. OOPS restores the last set of erased elements even if there was more than one command issued before you typed OOPS.*

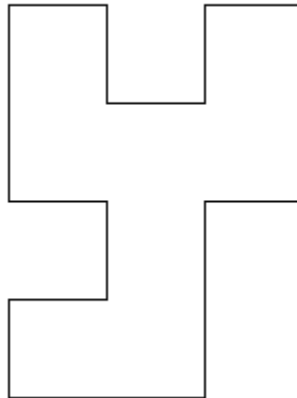

#### Solution

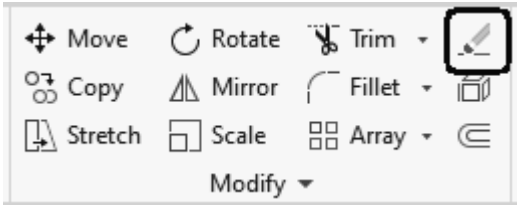
-  Invoke the **Erase** command (e or erase) on the Home ribbon.
- Select objects:*  
Select the objects by typing **ALL** and pressing <ENTER>, picking each line individually, or using the Window method. When all the objects are highlighted, press <ENTER> to execute the Erase command.
- Invoke the **Line** command (l or line).
- Specify first point:*  
Use your LMB to pick the start point of a line segment. Select any location on the drawing.



5. *Specify next point or [Undo]:*  
Continue to use the LMB to create lines on the drawing.
6. *Specify next point or [Close/Undo]:*  
Press the <ENTER> key to end the line command.
7. Type **OOPS** at the command line and press the <ENTER> key.



---

➤ *Select all the objects to erase, then press <ENTER> to execute the command. To remove an object from the selection set, hold down the shift key and select the object again. See that it is removed from the selection set. Then press <ENTER>.*

---

## **Review Questions**

1. How do you turn on the display of the coordinates in the status bar?
2. A user enters LINE 1,1 and then @0,2....what type of coordinates is she using?
3. To make sure you will always draw a straight line, what tray button should be enabled?
4. When using the POLAR method of coordinate entry, which tray button should be enabled?
5. When entering direct coordinates, which tray button should be disabled?
6. What is the difference between OOPS and UNDO?

## **Review Answers**

1. How do you turn on the display of the coordinates in the status bar?  
*Left click on the STATUS bar options icon and enable Coordinates*
2. A user enters LINE 1,1 and then @0,2 ....what type of coordinates is she using?  
*Relative*
3. To make sure you will always draw a straight line, what tray button should be enabled?  
*ORTHO*
4. When using the POLAR method of coordinate entry, which tray button should be enabled?  
*POLAR*
5. When entering direct coordinates, which tray button should be disabled?  
*DYN*
6. What is the difference between OOPS and UNDO?  
*UNDO reverses the last command entered. OOPS restores the last item(s) erased or deleted from the drawing.*