

Introduction to

# Finite Element Analysis Using SOLIDWORKS® Simulation 2023

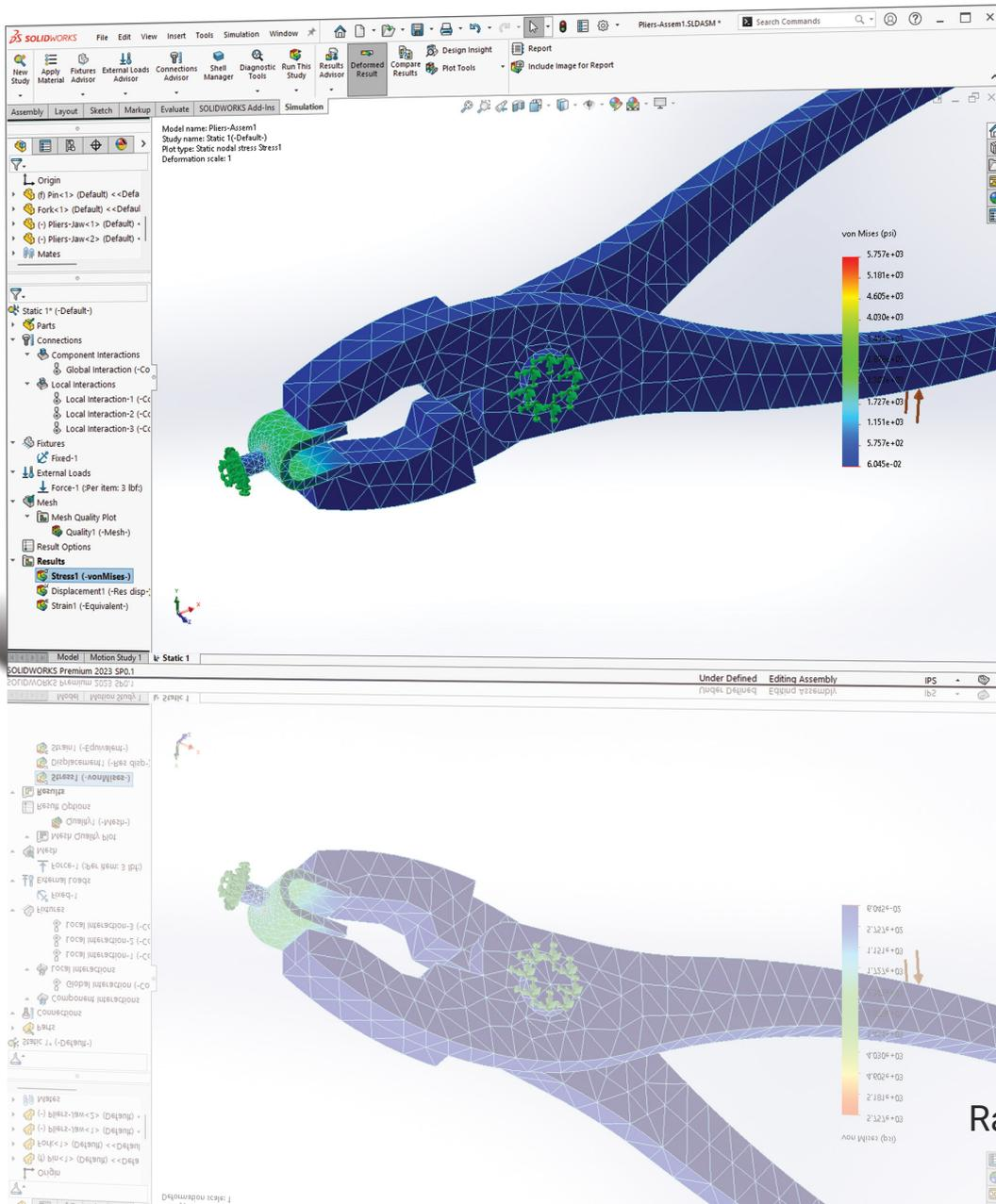

Randy H. Shih

Visit the following websites to learn more about this book:



[amazon.com](https://www.amazon.com)

[Google books](https://books.google.com)

[BARNES & NOBLE](https://www.barnesandnoble.com)

## Chapter 2

# Truss Elements in Two-Dimensional Spaces

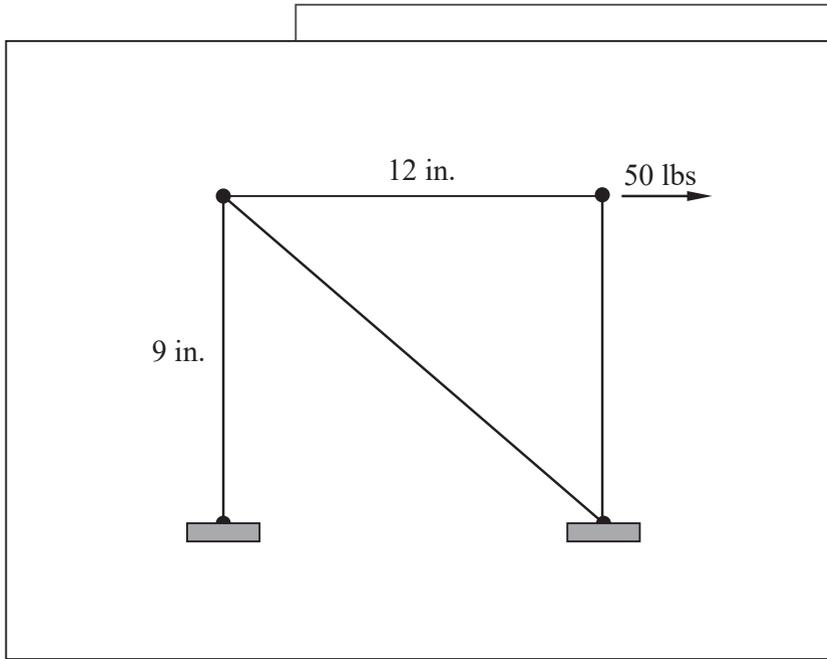

## Learning Objectives

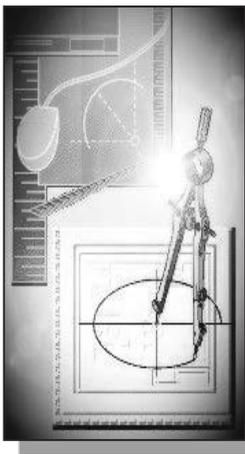

- ◆ Perform 2D Coordinate Transformation.
- ◆ Expand the Direct Stiffness Method to 2D Trusses.
- ◆ Derive the general 2D element Stiffness Matrix.
- ◆ Assemble the Global Stiffness Matrix for 2D Trusses.
- ◆ Solve 2D trusses using the Direct Stiffness Method.

## Introduction

This chapter presents the formulation of the direct stiffness method of truss elements in a two-dimensional space and the general procedure for solving two-dimensional truss structures using the direct stiffness method. The primary focus of this text is on the aspects of finite element analysis that are more important to the user than the programmer. However, for a user to utilize the software correctly and effectively, some understanding of the element formulation and computational aspects are also important. In this chapter, a two-dimensional truss structure consisting of two truss elements (as shown below) is used to illustrate the solution process of the direct stiffness method.

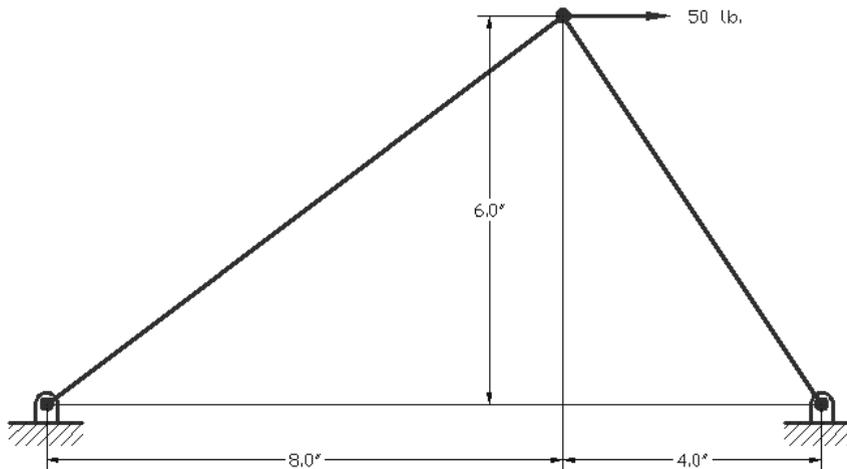

## Truss Elements in Two-Dimensional Spaces

As introduced in the previous chapter, the system equations (stiffness matrix) of a truss element can be represented using the system equations of a linear spring in one-dimensional space.

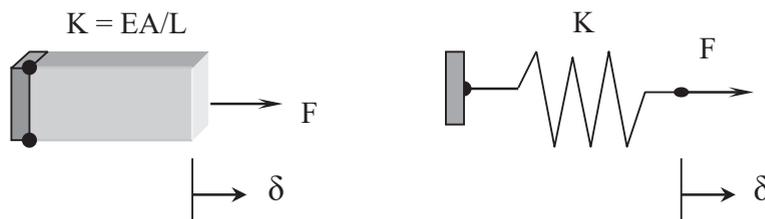

Free Body Diagram:

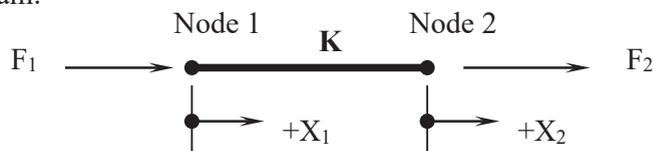

The general force-displacement equations in matrix form:

$$\begin{Bmatrix} F_1 \\ F_2 \end{Bmatrix} = \begin{bmatrix} +K & -K \\ -K & +K \end{bmatrix} \begin{Bmatrix} X_1 \\ X_2 \end{Bmatrix}$$

For a truss element,  $K = EA/L$ :

$$\begin{Bmatrix} F_1 \\ F_2 \end{Bmatrix} = \frac{EA}{L} \begin{bmatrix} +1 & -1 \\ -1 & +1 \end{bmatrix} \begin{Bmatrix} X_1 \\ X_2 \end{Bmatrix}$$

For truss members positioned in two-dimensional space, two coordinate systems are established:

1. The global coordinate system ( $X$  and  $Y$  axes) chosen to represent the entire structure.
2. The local coordinate system ( $X$  and  $Y$  axes) selected to align the  $X$  axis along the length of the element.

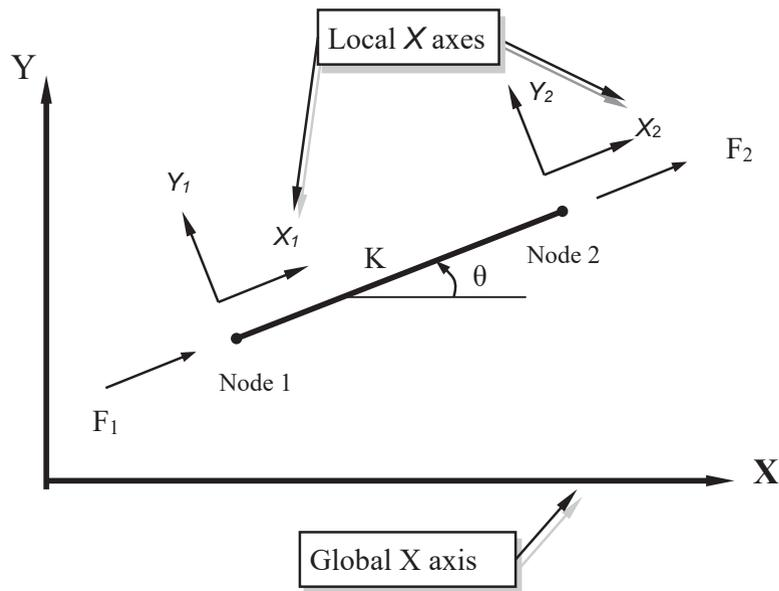

The force-displacement equations expressed in terms of components in the local  $XY$  coordinate system:

$$\begin{Bmatrix} F_{1X} \\ F_{2X} \end{Bmatrix} = \frac{EA}{L} \begin{bmatrix} +1 & -1 \\ -1 & +1 \end{bmatrix} \begin{Bmatrix} X_1 \\ X_2 \end{Bmatrix}$$

The above stiffness matrix (system equations in matrix form) can be expanded to incorporate the two force components at each node and the two displacement components at each node.

$$\begin{Bmatrix} F_{1X} \\ F_{1Y} \\ F_{2X} \\ F_{2Y} \end{Bmatrix} = \frac{\mathbf{EA}}{L} \begin{bmatrix} +1 & 0 & -1 & 0 \\ 0 & 0 & 0 & 0 \\ -1 & 0 & +1 & 0 \\ 0 & 0 & 0 & 0 \end{bmatrix} \begin{Bmatrix} X_1 \\ Y_1 \\ X_2 \\ Y_2 \end{Bmatrix}$$

Force Components  
(Local Coordinate System)
Nodal Displacements  
(Local Coordinate System)

In regard to the expanded local stiffness matrix (system equations in matrix form):

1. It is always a square matrix.
2. It is always symmetrical for linear systems.
3. The diagonal elements are always positive or zero.

The above stiffness matrix, expressed in terms of the established 2D local coordinate system, represents a single truss element in a two-dimensional space. In a general structure, many elements are involved, and they would be oriented with different angles. The above stiffness matrix is a general form of a SINGLE element in a 2D local coordinate system. Imagine the number of coordinate systems involved for a 20-member structure. For the example that will be illustrated in the following sections, two local coordinate systems (one for each element) are needed for the truss structure shown below. The two local coordinate systems ( $X_1Y_1$  and  $X_2Y_2$ ) are aligned to the elements.

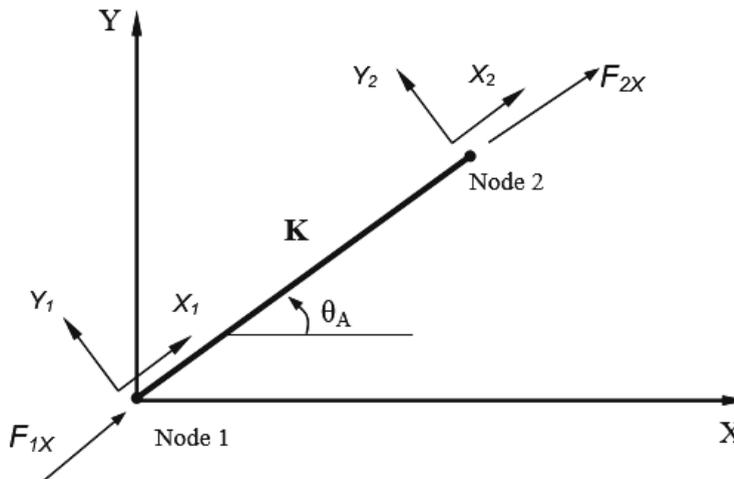

In order to solve the system equations of two-dimensional truss structures, it is necessary to assemble all elements' stiffness matrices into a **global stiffness matrix**, with all the equations of the individual elements referring to a common global coordinate system. This requires the use of *coordinate transformation equations* applied to system equations for all elements in the structure. For a one-dimensional truss structure (illustrated in chapter 2), the local coordinate system coincides with the global coordinate system; therefore, no coordinate transformation is needed to assemble the global stiffness matrix (the stiffness matrix in the global coordinate system). In the next section, the coordinate transformation equations are derived for truss elements in two-dimensional spaces.

## Coordinate Transformation

A vector, in a two-dimensional space, can be expressed in terms of any coordinate system set of unit vectors.

For example,

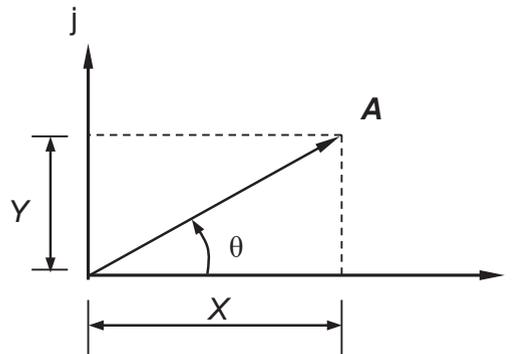

Vector **A** can be expressed as:

$$\mathbf{A} = X \mathbf{i} + Y \mathbf{j}$$

Where  $\mathbf{i}$  and  $\mathbf{j}$  are unit vectors along the  $X$  and  $Y$  axes.

Magnitudes of  $X$  and  $Y$  can also be expressed as:

$$\begin{aligned} X &= A \cos (\theta) \\ Y &= A \sin (\theta) \end{aligned}$$

Where  $X$ ,  $Y$  and  $A$  are scalar quantities.

Therefore,

$$\mathbf{A} = X \mathbf{i} + Y \mathbf{j} = A \cos (\theta) \mathbf{i} + A \sin (\theta) \mathbf{j} \text{ ----- (1)}$$

Next, establish a new unit vector ( $u$ ) in the same direction as vector  $A$ .

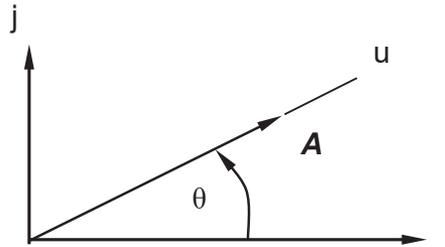

Vector  $A$  can now be expressed as:  $A = A u$  ----- (2)

Both equations, the above (1) and (2), represent vector  $A$ :

$$A = A u = A \cos (\theta) i + A \sin (\theta) j$$

The unit vector  $u$  can now be expressed in terms of the original set of unit vectors  $i$  and  $j$ :

$$u = \cos (\theta) i + \sin (\theta) j$$

Now consider another vector  $B$ :

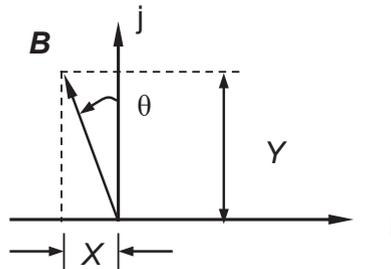

Vector  $B$  can be expressed as:

$$B = -X i + Y j$$

Where  $i$  and  $j$  are unit vectors along the  $X$ - and  $Y$ -axes.

Magnitudes of  $X$  and  $Y$  can also be expressed as components of the magnitude of the vector:

$$X = B \sin (\theta)$$

$$Y = B \cos (\theta)$$

Where  $X$ ,  $Y$  and  $B$  are scalar quantities.

Therefore,

$$B = -X i + Y j = -B \sin (\theta) i + B \cos (\theta) j$$
 ----- (3)

Next, establish a new unit vector ( $v$ ) along vector  $B$ .

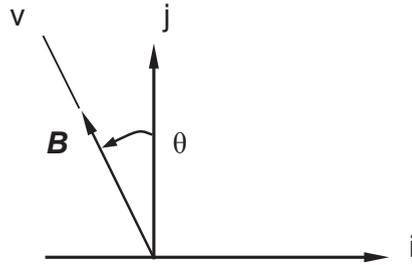

Vector  $B$  can now be expressed as:  $B = B v$  ----- (4)

Equations (3) and (4) represent vector  $B$ :

$$B = B v = - B \sin (\theta) i + B \cos (\theta) j$$

The unit vector  $v$  can now be expressed in terms of the original set of unit vectors  $i$  and  $j$ :

$$v = - \sin (\theta) i + \cos (\theta) j$$

We have established the coordinate transformation equations that can be used to transform vectors from  $ij$  coordinates to the rotated  $uv$  coordinates.

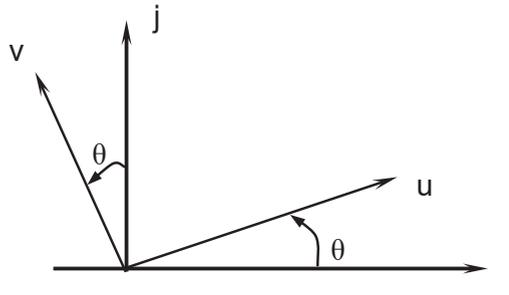

Coordinate Transformation Equations:

$$\begin{aligned} u &= \cos (\theta) i + \sin (\theta) j \\ v &= - \sin (\theta) i + \cos (\theta) j \end{aligned}$$

In matrix form,

$$\begin{Bmatrix} u \\ v \end{Bmatrix} = \begin{bmatrix} \cos (\theta) & \sin (\theta) \\ - \sin (\theta) & \cos (\theta) \end{bmatrix} \begin{Bmatrix} i \\ j \end{Bmatrix}$$

Direction cosines

The above *direction cosines* allow us to transform vectors from the GLOBAL coordinates to the LOCAL coordinates. It is also necessary to be able to transform vectors from the LOCAL coordinates to the GLOBAL coordinates. Although it is possible to derive the LOCAL to GLOBAL transformation equations in a similar manner as demonstrated for the above equations, the *MATRIX operations* provide a slightly more elegant approach.

The above equations can be represented symbolically as:

$$\{\mathbf{a}\} = [\mathbf{l}] \{\mathbf{b}\}$$

Where  $\{\mathbf{a}\}$  and  $\{\mathbf{b}\}$  are direction vectors,  $[\mathbf{l}]$  is the direction cosine.

Perform the matrix operations to derive the reverse transformation equations in terms of the above direction cosines:

$$\{\mathbf{b}\} = [?] \{\mathbf{a}\}$$

First, multiply by  $[\mathbf{l}]^{-1}$  to remove the *direction cosines* from the right hand side of the original equation.

$$\{\mathbf{a}\} = [\mathbf{l}] \{\mathbf{b}\}$$

$$[\mathbf{l}]^{-1} \{\mathbf{a}\} = [\mathbf{l}]^{-1} [\mathbf{l}] \{\mathbf{b}\}$$

From matrix algebra,  $[\mathbf{l}]^{-1} [\mathbf{l}] = [\mathbf{I}]$  and  $[\mathbf{I}] \{\mathbf{b}\} = \{\mathbf{b}\}$

The equation can now be simplified as

$$[\mathbf{l}]^{-1} \{\mathbf{a}\} = \{\mathbf{b}\}$$

For *linear statics analyses*, the *direction cosine* is an *orthogonal matrix* and the *inverse of the matrix* is equal to the *transpose of the matrix*.

$$[\mathbf{l}]^{-1} = [\mathbf{l}]^T$$

Therefore, the transformation equation can be expressed as:

$$[\mathbf{l}]^T \{\mathbf{a}\} = \{\mathbf{b}\}$$

The transformation equations that enable us to transform any vector from a *LOCAL coordinate system* to the *GLOBAL coordinate system* become:

LOCAL coordinates to the GLOBAL coordinates:

$$\begin{Bmatrix} i \\ j \end{Bmatrix} = \begin{bmatrix} \cos(\theta) & -\sin(\theta) \\ \sin(\theta) & \cos(\theta) \end{bmatrix} \begin{Bmatrix} u \\ v \end{Bmatrix}$$

The reverse transformation can also be established by applying the transformation equations that transform any vector from the *GLOBAL coordinate system* to the *LOCAL coordinate system*:

GLOBAL coordinates to the LOCAL coordinates:

$$\begin{Bmatrix} u \\ v \end{Bmatrix} = \begin{bmatrix} \cos(\theta) & \sin(\theta) \\ -\sin(\theta) & \cos(\theta) \end{bmatrix} \begin{Bmatrix} i \\ j \end{Bmatrix}$$

As is the case with many mathematical equations, derivation of the equations usually appears to be much more complex than the actual application and utilization of the equations. The following example illustrates the application of the two-dimensional coordinate transformation equations on a point in between two coordinate systems.

### Example 2.1

**Given:**

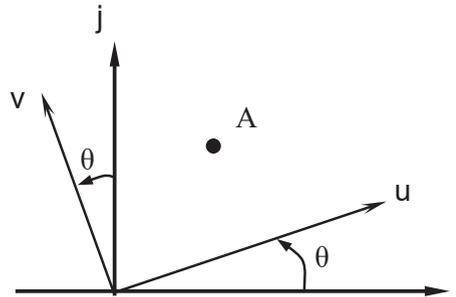

The coordinates of point A: (20 i, 40 j).

**Find:** The coordinates of point A if the local coordinate system is rotated 15 degrees relative to the global coordinate system.

**Solution:**

Using the coordinate transformation equations (GLOBAL coordinates to the LOCAL coordinates):

$$\begin{aligned} \begin{Bmatrix} u \\ v \end{Bmatrix} &= \begin{bmatrix} \cos(\theta) & \sin(\theta) \\ -\sin(\theta) & \cos(\theta) \end{bmatrix} \begin{Bmatrix} i \\ j \end{Bmatrix} \\ &= \begin{bmatrix} \cos(15^\circ) & \sin(15^\circ) \\ -\sin(15^\circ) & \cos(15^\circ) \end{bmatrix} \begin{Bmatrix} 20 \\ 40 \end{Bmatrix} \\ &= \begin{Bmatrix} 29.7 \\ 32.5 \end{Bmatrix} \end{aligned}$$

- On your own, perform a coordinate transformation to determine the global coordinates of point A using the *LOCAL* coordinates of (29.7,32.5) with the 15 degrees angle in between the two coordinate systems.

**Global Stiffness Matrix**

For a single truss element, using the coordinate transformation equations, we can proceed to transform the local stiffness matrix to the global stiffness matrix.

For a single truss element arbitrarily positioned in a two-dimensional space:

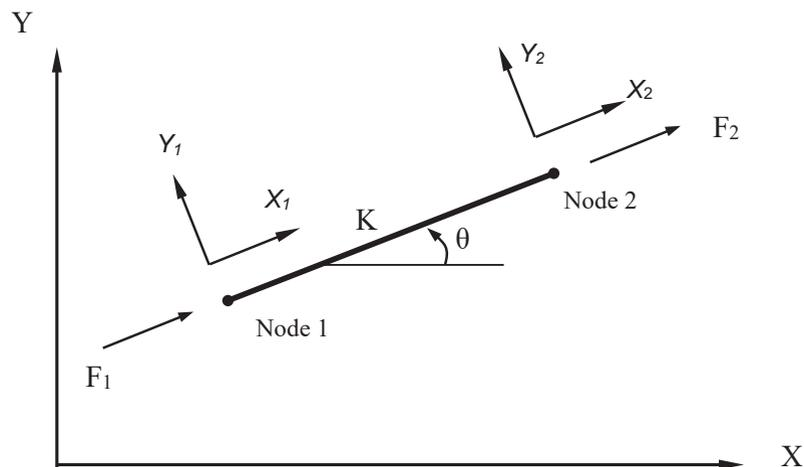

The force-displacement equations (in the local coordinate system) can be expressed as:

$$\begin{Bmatrix} F_{1X} \\ F_{1Y} \\ F_{2X} \\ F_{2Y} \end{Bmatrix} = \frac{EA}{L} \begin{bmatrix} +1 & 0 & -1 & 0 \\ 0 & 0 & 0 & 0 \\ -1 & 0 & +1 & 0 \\ 0 & 0 & 0 & 0 \end{bmatrix} \begin{Bmatrix} X_1 \\ Y_1 \\ X_2 \\ Y_2 \end{Bmatrix}$$

Local Stiffness Matrix

Next, apply the coordinate transformation equations to establish the general GLOBAL STIFFNESS MATRIX of a single truss element in a two-dimensional space.

First, the displacement transformation equations (GLOBAL to LOCAL):

$$\begin{Bmatrix} X_1 \\ Y_1 \\ X_2 \\ Y_2 \end{Bmatrix} = \begin{bmatrix} \cos(\theta) & \sin(\theta) & 0 & 0 \\ -\sin(\theta) & \cos(\theta) & 0 & 0 \\ 0 & 0 & \cos(\theta) & \sin(\theta) \\ 0 & 0 & -\sin(\theta) & \cos(\theta) \end{bmatrix} \begin{Bmatrix} X_1 \\ Y_1 \\ X_2 \\ Y_2 \end{Bmatrix}$$

Local
Global

The force transformation equations (GLOBAL to LOCAL):

$$\begin{Bmatrix} F_{1x} \\ F_{1y} \\ F_{2x} \\ F_{2y} \end{Bmatrix} = \begin{bmatrix} \cos(\theta) & \sin(\theta) & 0 & 0 \\ -\sin(\theta) & \cos(\theta) & 0 & 0 \\ 0 & 0 & \cos(\theta) & \sin(\theta) \\ 0 & 0 & -\sin(\theta) & \cos(\theta) \end{bmatrix} \begin{Bmatrix} F_{1x} \\ F_{1y} \\ F_{2x} \\ F_{2y} \end{Bmatrix}$$

Local
Global

The above three sets of equations can be represented as:

$\{F\} = [K]\{X\}$  ----- Local force-displacement equation

$\{X\} = [l]\{X\}$  ----- Displacement transformation equation

$\{F\} = [l]\{F\}$  ----- Force transformation equation

We will next perform *matrix operations* to obtain the GLOBAL stiffness matrix:  
Starting with the local force-displacement equation

$$\{F\} = [K]\{X\}$$

Next, substituting the transformation equations for  $\{F\}$  and  $\{X\}$ ,

$$[l]\{F\} = [K][l]\{X\}$$

Multiply both sides of the equation with  $[l]^T$ ,

$$[l]^T[l]\{F\} = [l]^T[K][l]\{X\}$$

The equation can be simplified as:

$$\{F\} = [l]^T[K][l]\{X\}$$

or

$$\{F\} = [l]^T[K][l]\{X\}$$

The GLOBAL force-displacement equation is then expressed as:

$$\{F\} = [l]^T[K][l]\{X\}$$

or

$$\{F\} = [K]\{X\}$$

The global stiffness matrix  $[K]$  can now be expressed in terms of the local stiffness matrix.

$$[K] = [l]^T[k][l]$$

For a single truss element in a two-dimensional space, the global stiffness matrix is

$$[K] = \frac{EA}{L} \begin{pmatrix} \cos^2(\theta) & \cos(\theta)\sin(\theta) & -\cos^2(\theta) & -\cos(\theta)\sin(\theta) \\ \cos(\theta)\sin(\theta) & \sin^2(\theta) & -\cos(\theta)\sin(\theta) & -\sin^2(\theta) \\ -\cos^2(\theta) & -\cos(\theta)\sin(\theta) & \cos^2(\theta) & \cos(\theta)\sin(\theta) \\ -\cos(\theta)\sin(\theta) & -\sin^2(\theta) & \sin(\theta)\cos(\theta) & \sin^2(\theta) \end{pmatrix}$$

- The above matrix can be applied to any truss element positioned in a two-dimensional space. We can now assemble the global stiffness matrix and analyze any two-dimensional multiple-elements truss structures. The following example illustrates, using the general global stiffness matrix derived above, the formulation and solution process of a 2D truss structure.

**Example 2.2**

**Given:** A two-dimensional truss structure as shown. (All joints are **Pin Joints**.)

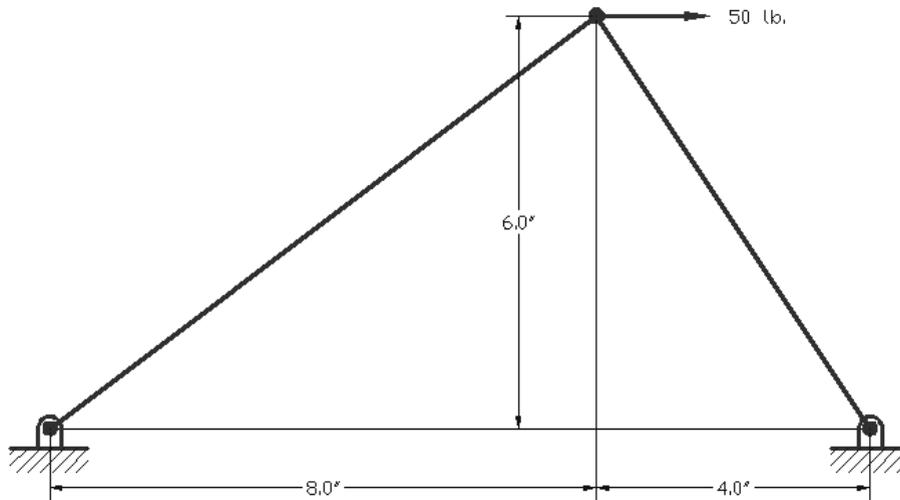

**Material:** Steel rod, diameter  $\frac{1}{4}$  in.

**Find:** Displacements of each node and stresses in each member.

**Solution:**

The system contains two elements and three nodes. The nodes and elements are labeled as shown below.

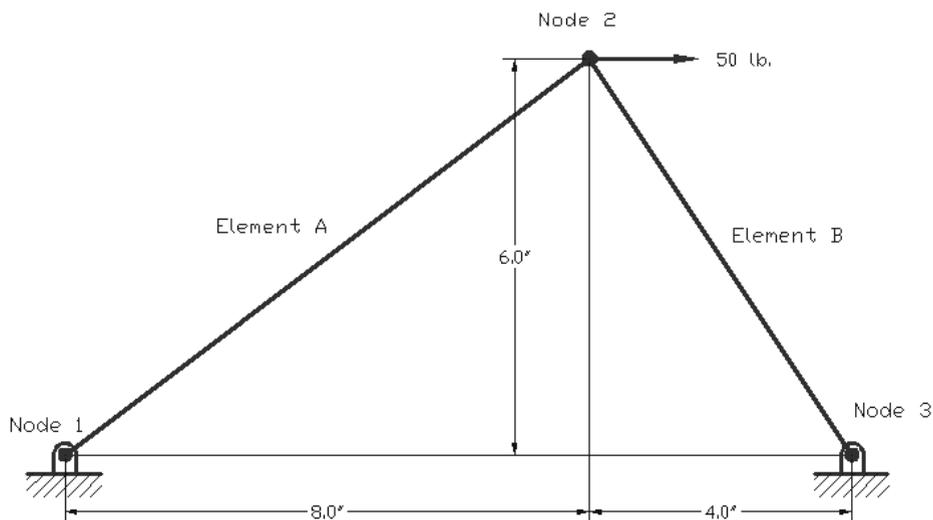

First, establish the GLOBAL stiffness matrix (system equations in matrix form) for each element.

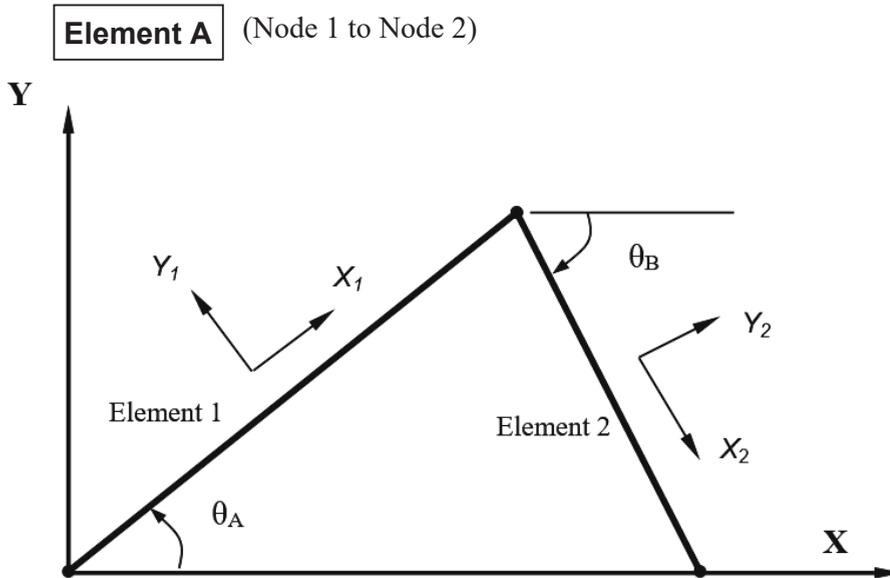

$$\theta_A = \tan^{-1}(6/8) = 36.87^\circ,$$

$$E \text{ (Young's modulus)} = 30 \times 10^6 \text{ psi}$$

$$A \text{ (Cross sectional area)} = \pi r^2 = 0.049 \text{ in}^2$$

$$L \text{ (Length of element)} = (6^2 + 8^2)^{1/2} = 10 \text{ in.}$$

Therefore,  $\frac{EA}{L} = 147262 \text{ lb/in.}$

The LOCAL force-displacement equations:

$$\begin{Bmatrix} F_{1X} \\ F_{1Y} \\ F_{2X} \\ F_{2Y} \end{Bmatrix} = \frac{EA}{L} \begin{bmatrix} +1 & 0 & -1 & 0 \\ 0 & 0 & 0 & 0 \\ -1 & 0 & +1 & 0 \\ 0 & 0 & 0 & 0 \end{bmatrix} \begin{Bmatrix} X_1 \\ Y_1 \\ X_2 \\ Y_2 \end{Bmatrix}$$

Labels in the diagram: "Local coordinate system" (top) points to the displacement vector; "Local coordinate system" (bottom left) points to the force vector; "Local Stiffness Matrix" (bottom right) points to the matrix.

Using the equations we have derived, the GLOBAL system equations for *Element A* can be expressed as:

$$\{ F \} = [ K ] \{ X \}$$

$$[ K ] = \frac{EA}{L} \begin{pmatrix} \cos^2(\theta) & \cos(\theta)\sin(\theta) & -\cos^2(\theta) & -\cos(\theta)\sin(\theta) \\ \cos(\theta)\sin(\theta) & \sin^2(\theta) & -\cos(\theta)\sin(\theta) & -\sin^2(\theta) \\ -\cos^2(\theta) & -\cos(\theta)\sin(\theta) & \cos^2(\theta) & \cos(\theta)\sin(\theta) \\ -\cos(\theta)\sin(\theta) & -\sin^2(\theta) & \sin(\theta)\cos(\theta) & \sin^2(\theta) \end{pmatrix}$$

Therefore,

$$\begin{Bmatrix} F_{1X} \\ F_{1Y} \\ F_{2XA} \\ F_{2YA} \end{Bmatrix} = 147262 \begin{bmatrix} .64 & .48 & -.64 & -.48 \\ .48 & .36 & -.48 & -.36 \\ -.64 & -.48 & .64 & .48 \\ -.48 & -.36 & .48 & .36 \end{bmatrix} \begin{Bmatrix} X_1 \\ Y_1 \\ X_2 \\ Y_2 \end{Bmatrix}$$

Global      Global Stiffness Matrix

**Element B** (Node 2 to Node 3)

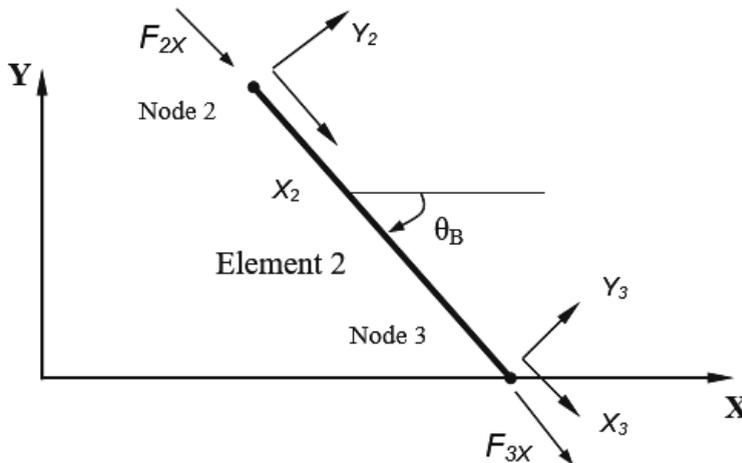

$$\theta_B = -\tan^{-1}(6/4) = -56.31^\circ \text{ (negative angle as shown)}$$

$$E \text{ (Young's modulus)} = 30 \times 10^6 \text{ psi}$$

$$A \text{ (Cross sectional area)} = \pi r^2 = 0.049 \text{ in}^2$$

$$L \text{ (Length of element)} = (4^2 + 6^2)^{1/2} = 7.21 \text{ in.}$$

$$\frac{EA}{L} = 204216 \text{ lb/in.}$$

$$\begin{Bmatrix} F_{2X} \\ F_{2Y} \\ F_{3X} \\ F_{3Y} \end{Bmatrix} = \frac{EA}{L} \begin{bmatrix} +1 & 0 & -1 & 0 \\ 0 & 0 & 0 & 0 \\ -1 & 0 & +1 & 0 \\ 0 & 0 & 0 & 0 \end{bmatrix} \begin{Bmatrix} X_2 \\ Y_2 \\ X_3 \\ Y_3 \end{Bmatrix}$$

Using the equations we derived in the previous sections, the GLOBAL system equation for *Element B* is:

$$\{ F \} = [ K ] \{ X \}$$

$$[ K ] = \frac{EA}{L} \begin{bmatrix} \cos^2(\theta) & \cos(\theta)\sin(\theta) & -\cos^2(\theta) & -\cos(\theta)\sin(\theta) \\ \cos(\theta)\sin(\theta) & \sin^2(\theta) & -\cos(\theta)\sin(\theta) & -\sin^2(\theta) \\ -\cos^2(\theta) & -\cos(\theta)\sin(\theta) & \cos^2(\theta) & \cos(\theta)\sin(\theta) \\ -\cos(\theta)\sin(\theta) & -\sin^2(\theta) & \sin(\theta)\cos(\theta) & \sin^2(\theta) \end{bmatrix}$$

Therefore,

$$\begin{Bmatrix} F_{2XB} \\ F_{2YB} \\ F_{3XB} \\ F_{3YB} \end{Bmatrix} = 204216 \begin{bmatrix} 0.307 & -0.462 & -0.307 & 0.462 \\ -0.462 & 0.692 & 0.462 & -0.692 \\ -0.307 & 0.462 & 0.307 & -0.462 \\ 0.462 & -0.692 & -0.462 & 0.692 \end{bmatrix} \begin{Bmatrix} X_2 \\ Y_2 \\ X_3 \\ Y_3 \end{Bmatrix}$$

Now we are ready to assemble the overall global stiffness matrix of the structure.

Summing the two sets of global force-displacement equations:

$$\begin{Bmatrix} F_{1X} \\ F_{1Y} \\ F_{2X} \\ F_{2Y} \\ F_{3X} \\ F_{3Y} \end{Bmatrix} = \begin{bmatrix} 94248 & 70686 & -94248 & -70686 & 0 & 0 \\ 70686 & 53014 & -70686 & -53014 & 0 & 0 \\ -94248 & -70686 & 157083 & -23568 & -62836 & 94253 \\ -70686 & -53014 & -23568 & 194395 & 94253 & -141380 \\ 0 & 0 & -62836 & 94253 & 62836 & -94253 \\ 0 & 0 & 94253 & -141380 & -94253 & 141380 \end{bmatrix} \begin{Bmatrix} X_1 \\ Y_1 \\ X_2 \\ Y_2 \\ X_3 \\ Y_3 \end{Bmatrix}$$

Next, apply the following known boundary conditions into the system equations:

- (a) Node 1 and Node 3 are fixed-points; therefore, any displacement components of these two node-points are zero ( $X_1, Y_1$  and  $X_3, Y_3$ ).
- (b) The only external load is at Node 2:  $F_{2x} = 50$  lbs.

Therefore,

$$\begin{Bmatrix} F_{1X} \\ F_{1Y} \\ 50 \\ 0 \\ F_{3X} \\ F_{3Y} \end{Bmatrix} = \begin{bmatrix} 94248 & 70686 & -94248 & -70686 & 0 & 0 \\ 70686 & 53014 & -70686 & -53014 & 0 & 0 \\ -94248 & -70686 & 157083 & -23568 & -628360 & 94253 \\ -70686 & -53014 & -23568 & 194395 & 94253 & -141380 \\ 0 & 0 & -62836 & 94253 & 62836 & -94253 \\ 0 & 0 & 94253 & -141380 & -94253 & 141380 \end{bmatrix} \begin{Bmatrix} 0 \\ 0 \\ X_2 \\ Y_2 \\ 0 \\ 0 \end{Bmatrix}$$

The two displacements we need to solve are  $X_2$  and  $Y_2$ . Let's simplify the above matrix by removing the unaffected/unnecessary columns in the matrix.

$$\begin{Bmatrix} F_{1X} \\ F_{1Y} \\ 50 \\ 0 \\ F_{3X} \\ F_{3Y} \end{Bmatrix} = \begin{bmatrix} -94248 & -70686 \\ -70686 & -53014 \\ 157083 & -23568 \\ -23568 & 194395 \\ -62836 & 94253 \\ 94253 & -141380 \end{bmatrix} \begin{Bmatrix} X_2 \\ Y_2 \end{Bmatrix}$$

Solve for nodal displacements  $X_2$  and  $Y_2$ :

$$\begin{Bmatrix} 50 \\ 0 \end{Bmatrix} = \begin{bmatrix} 157083 & -23568 \\ -23568 & 194395 \end{bmatrix} \begin{Bmatrix} X_2 \\ Y_2 \end{Bmatrix}$$

$$\mathbf{X}_2 = 3.24 \mathbf{e}^{-4} \text{ in.}$$

$$\mathbf{Y}_2 = 3.93 \mathbf{e}^{-5} \text{ in.}$$

Substitute the known  $X_2$  and  $Y_2$  values into the matrix and solve for the reaction forces:

$$\begin{Bmatrix} F_{1X} \\ F_{1Y} \\ F_{3X} \\ F_{3Y} \end{Bmatrix} = \begin{bmatrix} -94248 & -70686 \\ -70686 & -53014 \\ -62836 & 94253 \\ 94253 & -141380 \end{bmatrix} \begin{Bmatrix} 3.24 \mathbf{e}^{-4} \\ 3.93 \mathbf{e}^{-5} \end{Bmatrix}$$

Therefore,

$$\begin{aligned} F_{1X} &= -33.33 \text{ lbs.}, & F_{1Y} &= -25 \text{ lbs.} \\ F_{3X} &= -16.67 \text{ lbs.}, & F_{3Y} &= 25 \text{ lbs.} \end{aligned}$$

To determine the normal stress in each truss member, one option is to use the displacement transformation equations to transform the results from the global coordinate system back to the local coordinate system.

**Element A**

$$\{X\} = [l] \{X\} \quad \text{----- Displacement transformation equation}$$

$$\begin{Bmatrix} X_1 \\ Y_1 \\ X_2 \\ Y_2 \end{Bmatrix} = \begin{bmatrix} .8 & .6 & 0 & 0 \\ -.6 & .8 & 0 & 0 \\ 0 & 0 & .8 & .6 \\ 0 & 0 & -.6 & .8 \end{bmatrix} \begin{Bmatrix} 0 \\ 0 \\ X_2 \\ Y_2 \end{Bmatrix}$$

Local
Global

$$\begin{aligned} X_2 &= 2.83 \text{ e}^{-4} \\ Y_2 &= -1.63 \text{ e}^{-4} \end{aligned}$$

The LOCAL force-displacement equations:

$$\begin{Bmatrix} F_{1X} \\ F_{1Y} \\ F_{2X} \\ F_{2Y} \end{Bmatrix} = \frac{EA}{L} \begin{bmatrix} +1 & 0 & -1 & 0 \\ 0 & 0 & 0 & 0 \\ -1 & 0 & +1 & 0 \\ 0 & 0 & 0 & 0 \end{bmatrix} \begin{Bmatrix} X_1 \\ Y_1 \\ X_2 \\ Y_2 \end{Bmatrix}$$

Local system
Local system
Local Stiffness Matrix

$$\begin{aligned} F_{1X} &= -41.67 \text{ lbs.}, & F_{1Y} &= 0 \text{ lb.} \\ F_{2X} &= 41.67 \text{ lbs.}, & F_{2Y} &= 0 \text{ lb.} \end{aligned}$$

Therefore, the normal stress developed in *Element A* can be calculated as  $(41.67/0.049)=850 \text{ psi}$ .

➤ On your own, calculate the normal stress developed in *Element B*.

**Questions:**

1. Determine the coordinates of point A if the local coordinate system is rotated 15 degrees relative to the global coordinate system. The global coordinates of point A: (30,50).

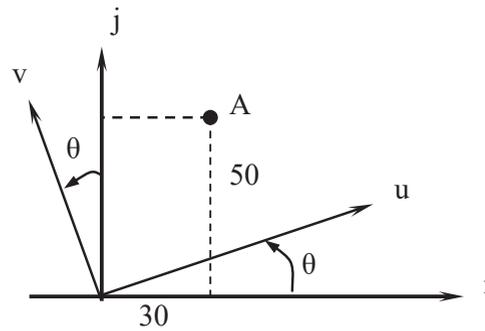

2. Determine the global coordinates of point B if the local coordinate system is rotated 30 degrees relative to the global coordinate system. The local coordinates of point B: (30,15).

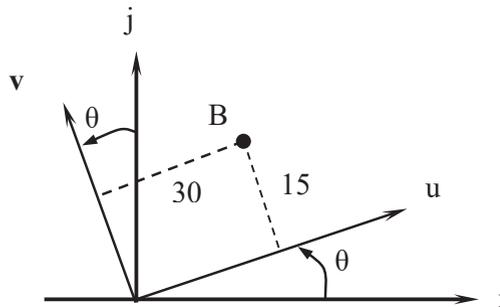

**Exercises:**

1. Given: two-dimensional truss structure as shown. (All joints are pin joints.)

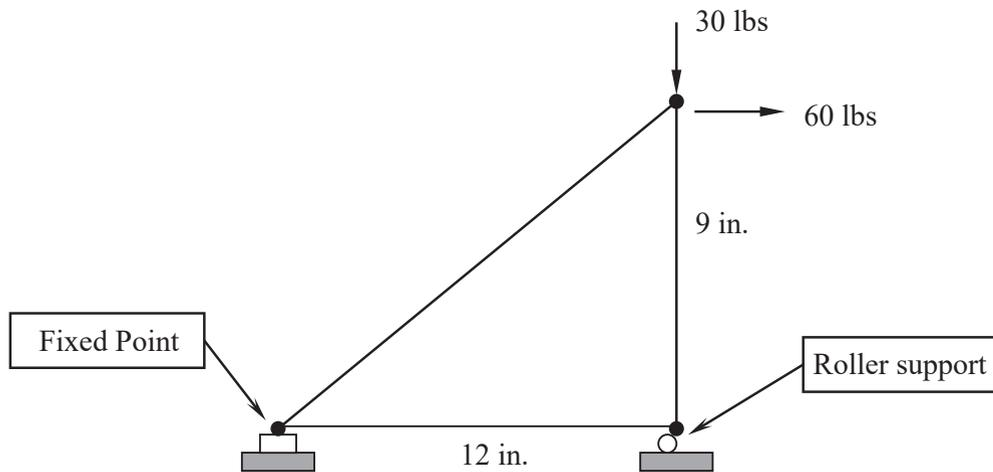

Material: Steel, diameter  $\frac{1}{4}$  in.

- Find: (a) Displacements of the nodes.  
(b) Normal stresses developed in the members.

2. Given: Two-dimensional truss structure as shown. (All joints are pin joints.)

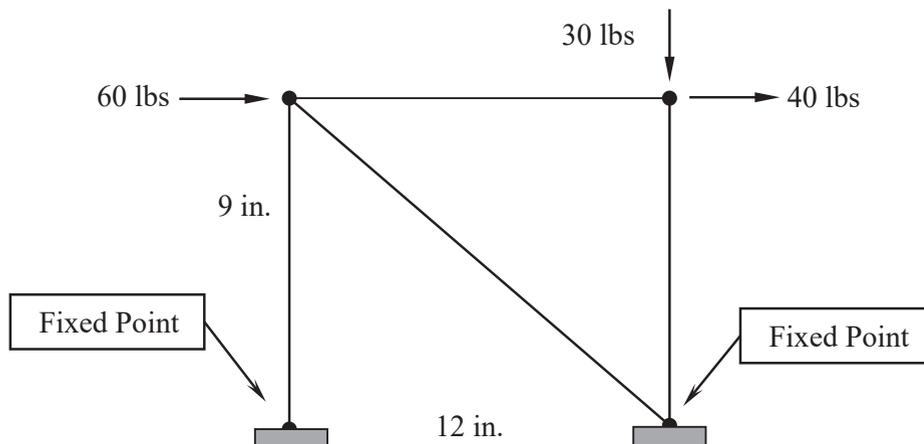

Material: Steel, diameter  $\frac{1}{4}$  in.

- Find: (a) Displacements of the nodes.  
(b) Normal stresses developed in the members.