

Residential Design Using Autodesk® Revit® 2024

Includes video instruction



Daniel John Stine AIA, IES, CSI, CDT, Well AP



Better Textbooks. Lower Prices.
www.SDCpublications.com



ACCESS CODE
UNIQUE CODE INSIDE

Visit the following websites to learn more about this book:



[amazon.com](https://www.amazon.com)

[Google books](https://books.google.com)

[BARNES & NOBLE](https://www.barnesandnoble.com)

Lesson 3

Overview of Linework and Modify Tools:

It may seem odd to you that, in a revolutionary 3D design program, you will begin by learning to draw and edit 2D lines and shapes. However, any 3D object requires, at a minimum, detailed information in at least two of the three dimensions. Once two dimensions are defined, Autodesk® Revit® can begin to automate much of the third dimension for you. Many building components and features will require you to draw the perimeter using 2D lines.

Many of the edit tools that are covered in this lesson are the same tools that are used to edit the 3D building components.

Exercise 3-1:

Lines and Shapes

Drawing Lines:

You will draw many 2D lines in Autodesk Revit, typically in what is called *Sketch* mode. Two dimensional lines in Autodesk Revit are extremely precise drawing elements. This means you can create very accurate drawings. Lines, or any drawn object, can be as precise as 8 decimal places (i.e., 24.99999999) or 1/256.

Autodesk Revit is a vector-based program. That means each drawn object is stored in a numerical database. When geometry needs to be displayed on the screen, Autodesk Revit reads from the project database to determine what to display on the screen. This ensures that the line will be very accurate at any scale or zoom magnification.

A raster-based program, in contrast to vector based, is comprised of dots that infill a grid. The grid can vary in density and is typically referred to as resolution (e.g., 600x800, 1600x1200, etc.). This file type is used by graphics programs that typically deal with photographs, such as Adobe Photoshop. There are two reasons this type of file is not appropriate for Computer Aided Design (CAD) programs:

- A raster-based line, for example, is composed of many dots on a grid, representing the line's width. When you zoom in, magnifying the line, it starts to become pixilated, meaning you actually start to see each dot on the grid. In a vector file you can "infinitely" zoom in on a line and it will never become pixilated because the program recalculates the line each time you zoom in.

- A CAD program, such as Revit, only needs to store the starting point and end point coordinates for each wall. For example, the dots needed to draw the wall are calculated on-the-fly for the current screen resolution, whereas a raster file must store each dot that represents the full length and width of the line, or lines in the wall, for example. This can vary from a few hundred dots to several thousand dots, depending on the resolution, for the same line.

The following graphic illustrates this point:

Vector vs. Raster Lines:

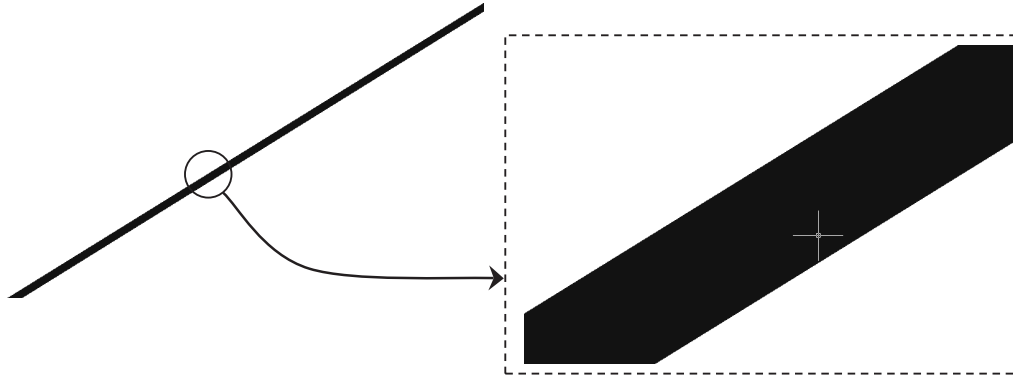

FIGURE 3-1.1 Vector Line Example
File Size: approx. 33kb

FIGURE 3-1.1A Vector Line Enlarged 1600%

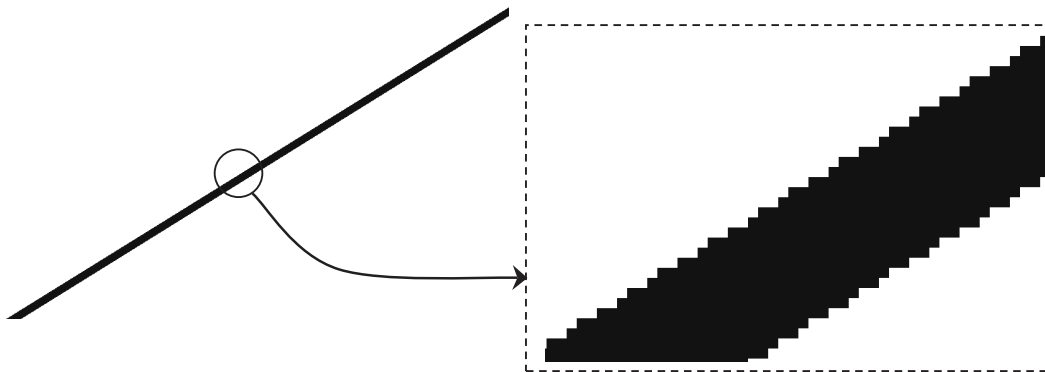

FIGURE 3-1.2 Raster Line Example
File Size: approx. 4.4MB

FIGURE 3-1.2A Raster Line Enlarged 1600%

The Detail Lines Tool:

You will now study the *Detail Lines* tool.

1. **Open** Revit.

Each time you start Revit, you are in the *Recent Files* view. This view is closed automatically when a new or existing project is opened.

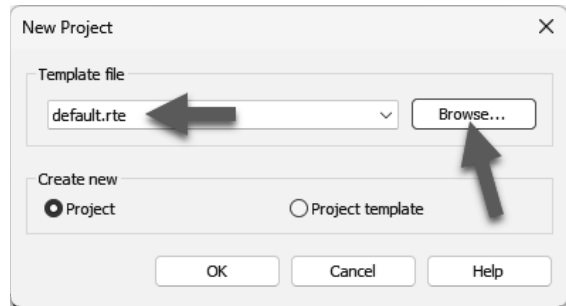

2. Start a new project: select **File Tab** → **New** → **Project** click **Browse**, select **default.rte**, and then click **Open** and then **OK**.
 - a. Or, click **New...** (Models) from the *Home* screen.

The drawing window is set to the *Level 1 Floor Plan* view. The 2D drafting will be done in a drafting view. Next you will learn how to create one of these views.

3. Select **View** → **Create** → **Drafting View**.
(Remember: this means *Tab* → *Panel* → *Icon* on the *Ribbon*.)
4. In the *New Drafting View* dialog box, type **Ex 3-1** for the *Name* and set the *Scale* to **3/4" = 1'-0"** by clicking the down-arrow at the right (Figure 3-1.3).

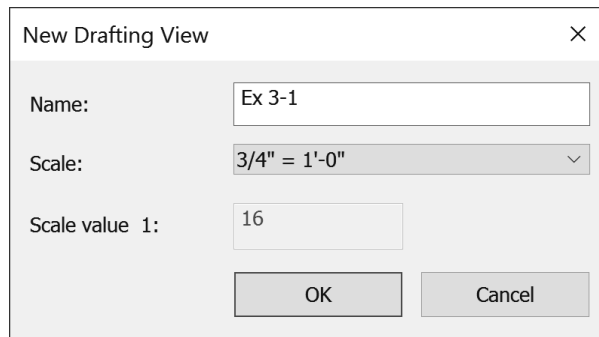

FIGURE 3-1.3 New Drafting View dialog

You are now in the new view and the *Project Browser* will contain a node labeled *Drafting Views (Detail)*. Here, each *Drafting View* created will be listed.

5. In the *Project Browser*, click the plus symbol next to the label **Drafting Views (Detail)**; this will display the *Drafting Views* that exist in the current project (Figure 3-1.4).

You are now ready to start looking at the *Detail Lines* tool:

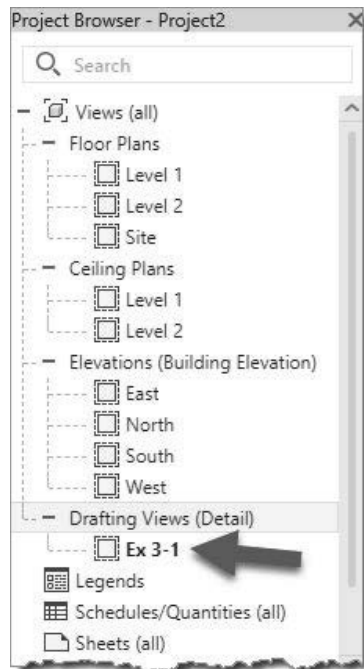

FIGURE 3-1.4 Project Browser: Drafting Views

After clicking your second point, you should notice the length and the angle of the line are graphically displayed; this information is temporary and will disappear when you move your cursor.

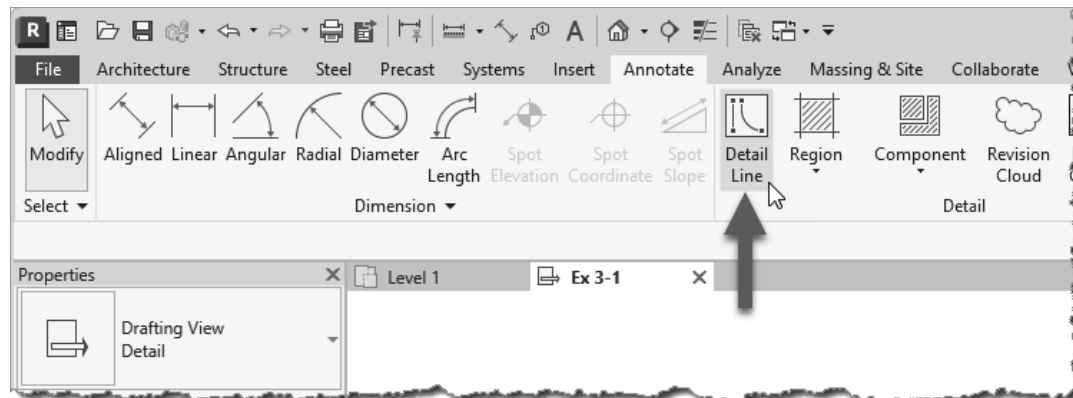

FIGURE 3-1.5 Annotate tab

6. Select the **Annotate** tab on the *Ribbon*.

7. On the *Detail* panel, select **Detail Line** (Figure 3-1.5).
TIP: Do not use the “Model Line” tool on the Architecture tab.



8. **Draw a line** from the lower left corner of the screen to the upper right corner of the screen, by simply clicking two points on the screen within the drawing window (Figure 3-1.6).

NOTE: Do not drag or hold your mouse button down; just click.

You should also notice that the *Detail Line* tool is still active, which means you could continue to draw additional lines on the screen.

9. After clicking your second point, select the **Modify** tool from the left side of the *Ribbon*.



Selecting *Modify* cancels the current tool and allows you to select portions of your drawing for information or editing. Revit conveniently places the *Modify* tool in the same location on each tab so it is always available no matter which tab on the *Ribbon* is active.

TIP: Pressing the *Esc* key twice reverts Revit back to *Modify* mode.

Did You Make a Mistake?



Whenever you make a mistake in Revit you can use the **UNDO** command, via the *QAT*, to revert to a previous drawing state. You can perform multiple UNDOs all the way to your previous *Save*.

Similarly, if you press Undo a few too many times, you can use **REDO**. 

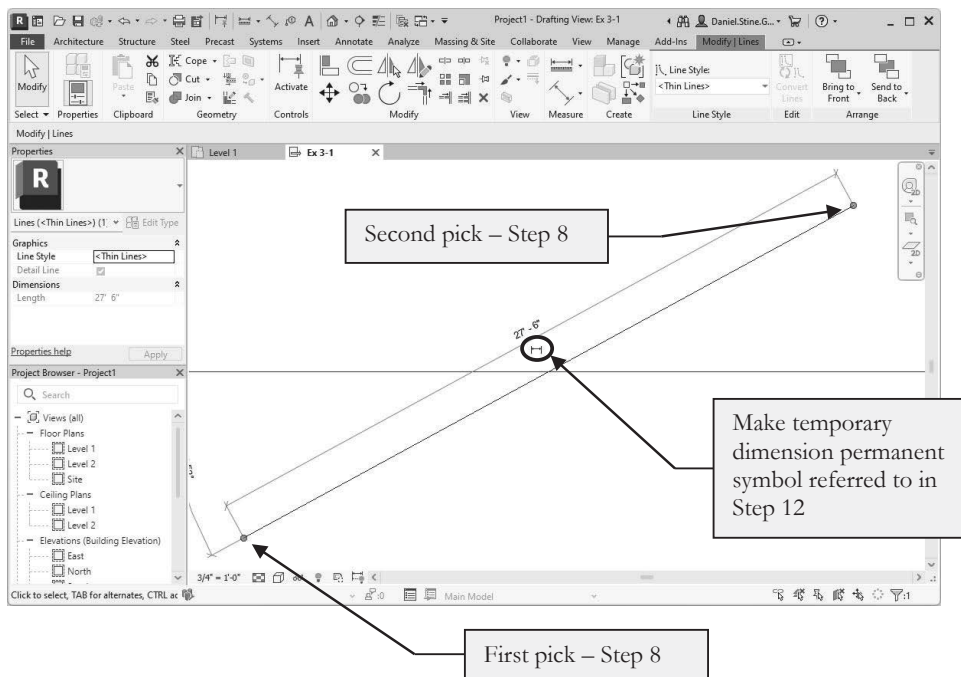

FIGURE 3-1.6 Your first detail line; exact dimensions are not important at this point.

Notice in the image above, that while the *Detail Line* tool is active, the *Modify | Place Detail Line* contextual tab is shown. As soon as you click the *Modify* button or press *Esc*, the tab reverts back to the basic *Modify* tab.

This constitutes your first line! However, as you are probably aware, it is not a very accurate line as far as length and angle are concerned. Your line will likely be a different length due to where you picked your points and the size and resolution of your monitor.

Typically, you need to provide information such as length and angle when drawing a line; you rarely pick arbitrary points on the screen as you did in the previous steps. Revit allows you to get close with the on-screen dimension and angle information. Most of the time you also need to accurately pick your starting point. For example, how far one line is from another or picking the exact middle point on another line.

Having said that, however, the line you just drew still has precise numbers associated with its length and angle; this information is displayed after the line is drawn. The dimension and angle information is displayed until you begin to draw another line or select another tool. You can also select the line. While the dimensions are still visible, they can be used to modify the length and angle of the line; you will try that later.

10. If not already selected, click the **Modify** tool from the *Ribbon*.

Notice that the temporary dimensions have disappeared.

While you are in *Modify* mode, you can select lines and objects in the current view.

11. Now **select the line** by clicking the mouse button with the cursor directly over the line.

FYI: *Always use the left button unless the right button is specifically mentioned.*

Notice that the temporary dimensions have returned.

The following step shows how to make a temporary dimension permanent:

If, at any point, you want to make a temporary dimension permanent, you simply click the “make this temporary dimension permanent” symbol near the dimension. You will try this now.

12. With the diagonal line still selected, click the “make this temporary dimension permanent” symbol near the dimension (Figure 3-1.6).



13. Select **Modify** to unselect the line.

The dimension indicating the length of the line is now permanent (Figure 3-1.7). The value of your dimension will not be the same as the one in this book as the size of your monitor and the exact points picked can vary greatly.

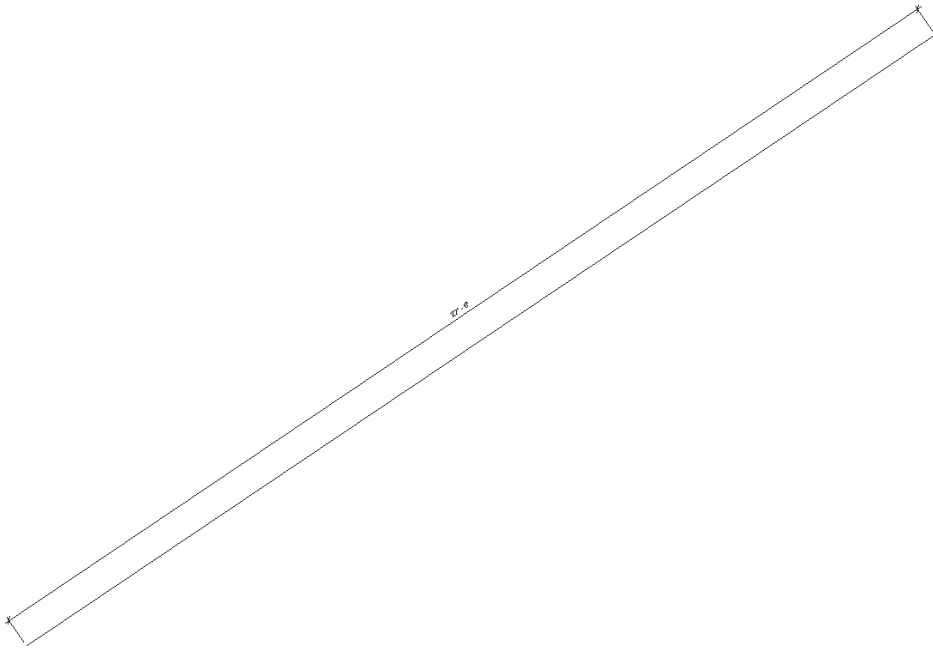

FIGURE 3-1.7 Temp dimension converted to permanent dimension

The following shows how to change the length of the line:

Currently, the line is approximately 20 - 30' long (27'-6" in Figure 3-1.7). If you want to change the length of the line to 22'-6", you select the line and then change the dimension text, which in turn changes the line length. This can also be done with the temporary dimensions; the key is that the line has to be selected. You will try this next.

***FYI:** Your detail line length will vary slightly depending on the size and resolution of your computer monitor, as you will be seeing more or less of the drawing area. This also assumes you have not performed any zooming, including spinning the wheel button on your mouse. If your line is way off, you should Undo or start over so the next several steps work out as intended.*

14. In *Modify* mode, select the diagonal line.
15. With the line currently selected, click on the dimension-text.

A dimension-text edit box appears directly over the dimension, within the drawing window. Whatever you type as a dimension changes the line to match.

16. Type **22 6** (i.e., 22 *space* 6) and press **Enter** (Figure 3-1.8).

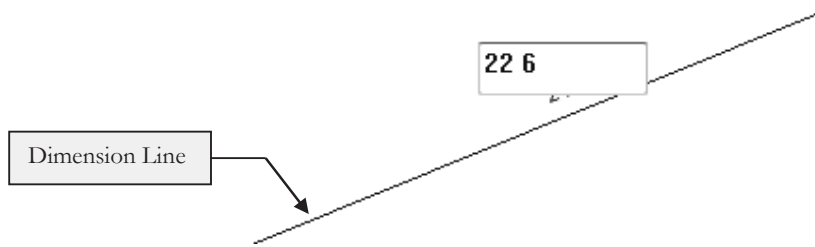

FIGURE 3-1.8 Editing dimension to change line length

You should have noticed the line changed length. Revit assumes that you want the line to change length equally at each end, so the midpoint does not move. Try changing the dimension to 100' and then Undo.

Locking Dimensions:

Revit allows you to *Lock* a dimension, which prevents the dimension and line length from changing. You will investigate this now to help avoid problems later.

17. Make sure the line is *not* selected; to do this press Esc or click *Modify*.
18. Select the dimension, not the line, and note the following about the selected dimension (Figure 3-1.9).

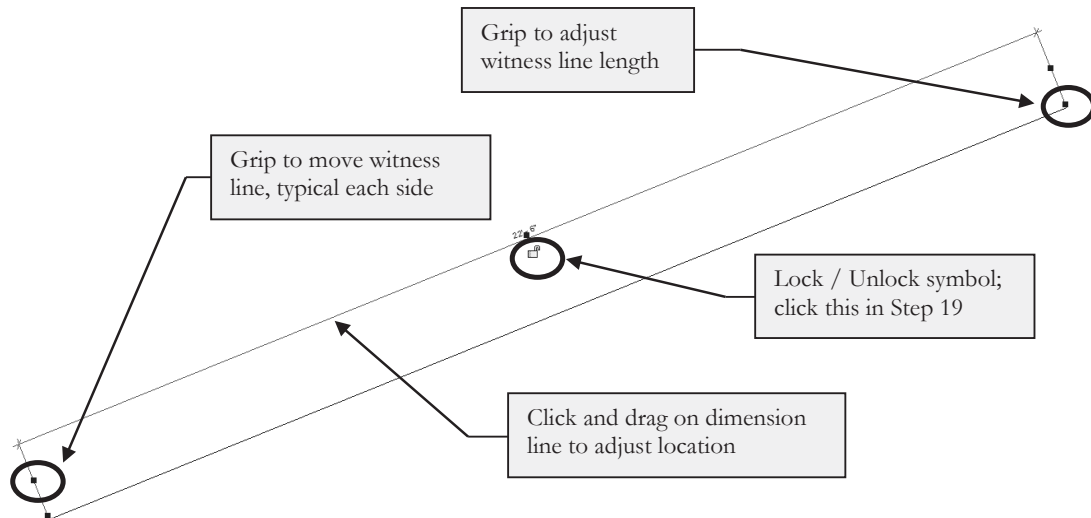

FIGURE 3-1.9 Selected dimension

19. Click on the **Lock/Unlock** padlock symbol to lock the dimension (Figure 3-1.9).



The dimension is now locked. Again, this means that you cannot change the dimension OR the line, though you can move it. The dimension is attached to the line in such a way that changing one affects the other. Next you will see what happens when you try to modify the dimension while it is locked.

Any time the line or dimension is selected you will see the lock or unlock symbol in the locked position.



FYI: Clicking the dimension's padlock icon anytime it is visible will toggle the setting between locked and unlocked.

20. Select **Modify** to unselect the *Dimension*.
21. Select the line (not the dimension).
22. Click on the dimension text and attempt to modify the line length to **21'**.

As you can see, Revit will not let you edit the text.

Even though your current view is showing a relatively small area, i.e., your *Drafting View*, it is actually an infinite drawing board.

In architectural CAD drafting, everything is drawn true to life size, or full-scale, ALWAYS! If you are drawing a building, you might draw an exterior wall that is 600'-0" long. If you are drawing a window detail, you might draw a line that is 8" long. In either case you are entering that line's actual length.

You could, of course, have an 8" line and a 600'-0" line in the same *Drafting View*. Either line would be difficult to see at the current drawing magnification (i.e., approximately 22' x 16' area; also recall that your diagonal line is 22'-6" long). So, you would have to zoom in to see the 8" line and zoom out to see the 600'-0" line. Next you will get to try this.

When the diagonal line is selected, notice the *Properties Palette* lists the type of entity selected (i.e., Lines), the *Style* (i.e., Thin Lines) and the *Length* (i.e., 22'-6"). See Chapter 1 for more information on the *Properties Palette* and how to open it if you accidentally closed it.

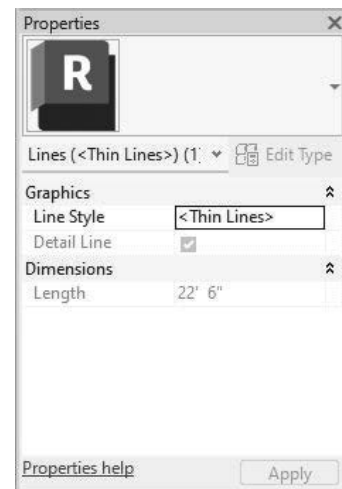

FIGURE 3-1.10 Properties Palette with diagonal line selected

Draw an 8" Line:

The next steps will walk you through drawing an 8" horizontal line. Revit provides more than one way to do this. You will try one of them now.

23. Select **Annotate** → **Detail** → **Detail Line**.
24. Pick a point somewhere in the upper left corner of the drawing window.
25. Start moving the mouse towards the right and generally horizontal until you see a dashed reference line extending in each direction of your line appear on the screen, as in Figure 3-1.11.

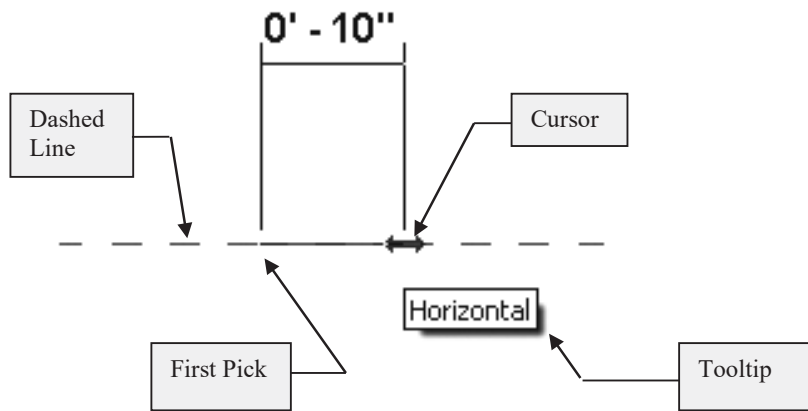

FIGURE 3-1.11 Drawing a line with the help of Revit

TIP: You will see a dashed horizontal line and a tooltip when the line is horizontal.

As you move the mouse left and right, you will notice Revit displays various dimensions that allow you to quickly draw your line at these often-used increments. See the next exercise to learn more about how to control the increments shown.

26. With the dashed line and *tooltip* visible on the screen, take your hand off the mouse, so you do not accidentally move it, and type **8"** and then press **Enter**.

TIP: Remember, you have to type the inch symbol; Revit always assumes you mean feet unless you specify otherwise. A future lesson will review the input options in more detail.

You have just drawn a line with a precise length and angle!

27. Use the **Measure** tool to verify it was drawn correctly. Click *Modify* → *Measure* → *Measure (down arrow)* → *Measure Between Two References*

28. Use the **Zoom In Region** tool to enlarge the view of the 8" line via the *Navigation Bar* (image to right).



29. Now use the **Zoom to Fit** or **Previous Pan/Zoom** tools so that both lines are visible again.

Draw a 600' Line:

- 30. Select the **Detail Line** tool and pick a point in the lower right corner of the drawing window.
- 31. Move the cursor straight up from your first point so that the line snaps to the vertical and the dashed line appears (Figure 3-1.12).
- 32. With the dashed line and *tooltip* visible on the screen, take your hand off the mouse so you do not accidentally move it; type **600** and then press **Enter**.

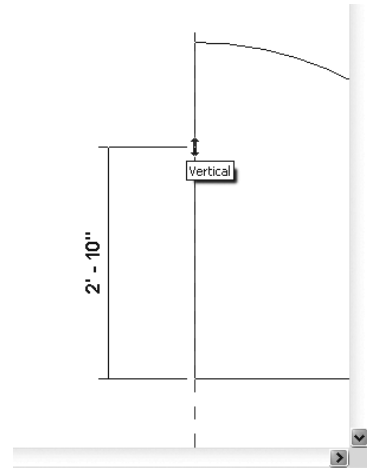

FIGURE 3-1.12 Drawing another Detail Line; 600'-0" vertical line – lower right

TIP #1: Notice this time you did not have to type the foot symbol (').

TIP #2: You do not need to get the temporary dimension close to reading 600'; the temporary dimension is ignored when you type in a value.

33. Press the **Esc** key twice to exit the *Detail Line* tool and return to the *Modify* mode.

Because the visible portion of the drawing area is only about 16' tall, you obviously would not expect to see a 600' line. You need to change the drawing's magnification by zooming out to see it.

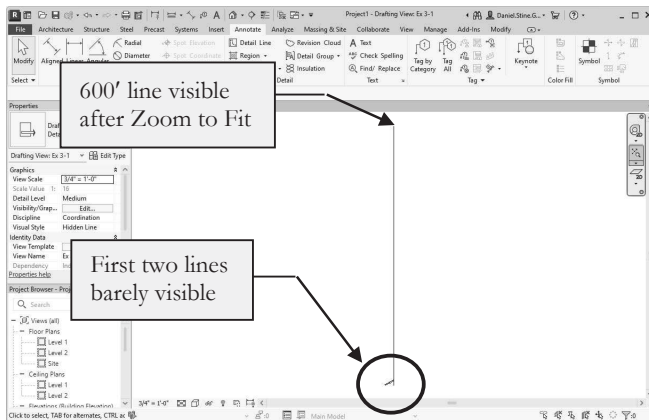

FIGURE 3-1.13 Detail view with three lines

34. Use **Zoom to Fit** to see the entire drawing (Fig. 3-1.13).

TIP: Double-click your wheel button to **Zoom Extents**.

Drawing Shapes:

Revit provides several tools to draw common shapes like squares, rectangles, circles and ellipses. These tools can be found on the *Ribbon* while the *Detail Line* tool is active. You will take a look at *Rectangle* and *Circle* now.

Creating a Rectangle:

35. Use *Previous Pan/Zoom*, or *Zoom Region*, to get back to the original view where the diagonal line spans the screen.
36. Select the *Detail Line* tool.

Notice the *Ribbon*, *Options Bar* and *Properties Palette* have changed to show various options related to *Detail Lines* (Figure 3-1.14).

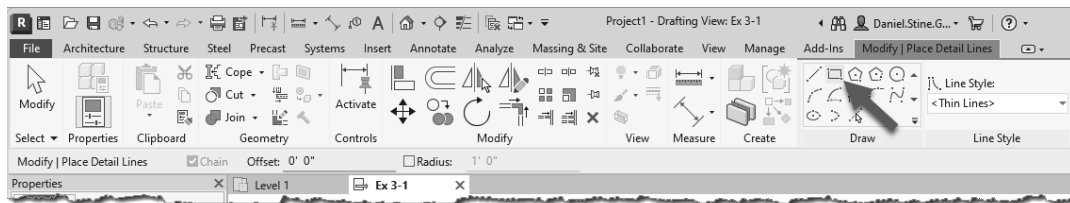

FIGURE 3-1.14 Place Detail Lines contextual Tab on Ribbon

37. Select the **Rectangle** tool from the *Ribbon*.

TIP: Hover your cursor over the icon to see tooltip until you learn what tools the icons represent.

38. Pick the “**first corner point**” somewhere near the lower center of the drawing window (Figure 3-1.15).

Notice the temporary dimensions are displaying a dimension for both the width and height. At this point you can pick a point on the screen, trying to get the dimensions correct before clicking the mouse button. If you do not get the rectangle drawn correctly, you can click on each dimension-text and change the dimension while the temporary dimensions are displayed; see the next two steps for the rectangle dimensions.

39. Draw a 2'-8" x 4'-4" rectangle using the temporary dimensions displayed on the screen; if you do not draw it correctly do the following:
 - a. Click the dimension-text for the horizontal line, then type **2'-8"** and then press **Enter**.
 - b. Type **4'-4"** and then press **Enter** for the vertical dimension.

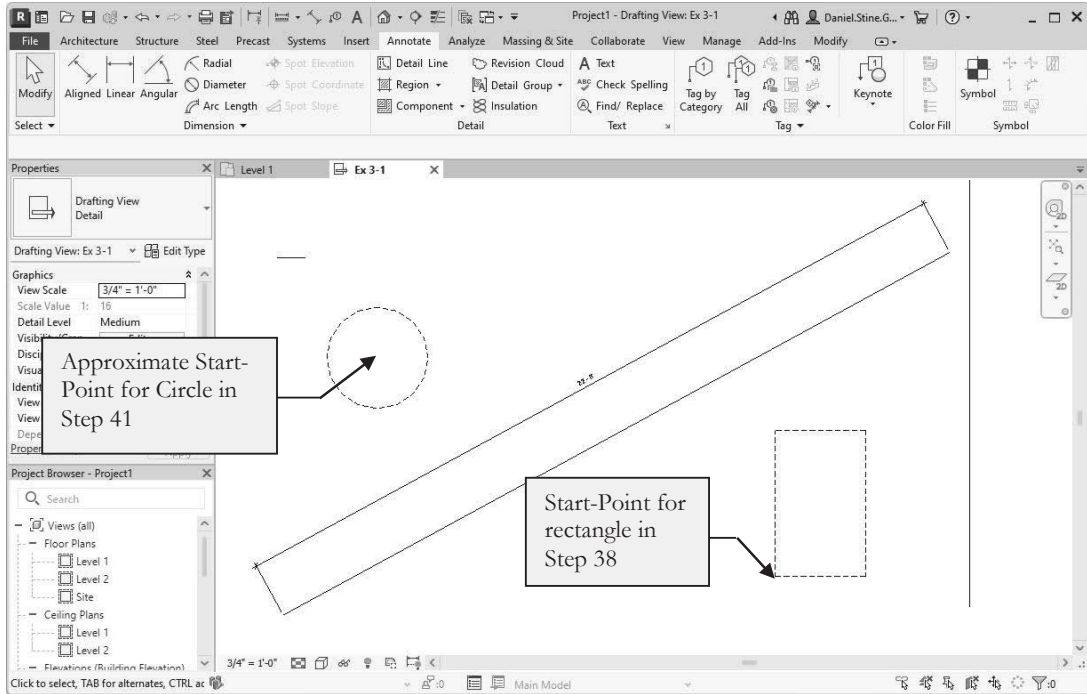

FIGURE 3-1.15 Drawing with Rectangle and Circle to be added (shown dashed for clarity)

Creating a Circle:

40. With the *Detail Line* tool active, select **Circle** from the *Ribbon* (Figure 3-1.16).
41. You are now prompted to pick the center point for the circle; pick a point approximately as shown in Figure 3-1.15.



FIGURE 3-1.16 Detail Line shapes

You should now see a dynamic circle and a temporary dimension attached to your cursor, which allows you to visually specify the circle's size. Move your mouse around to see that you could arbitrarily pick a point on the screen to create a quick circle if needed, then proceed to Step 42 where you will draw a circle with a radius of 1'-6⁵/₈".

42. Type **1 6 5/8** and then press **Enter** (Figure 3-1.17).

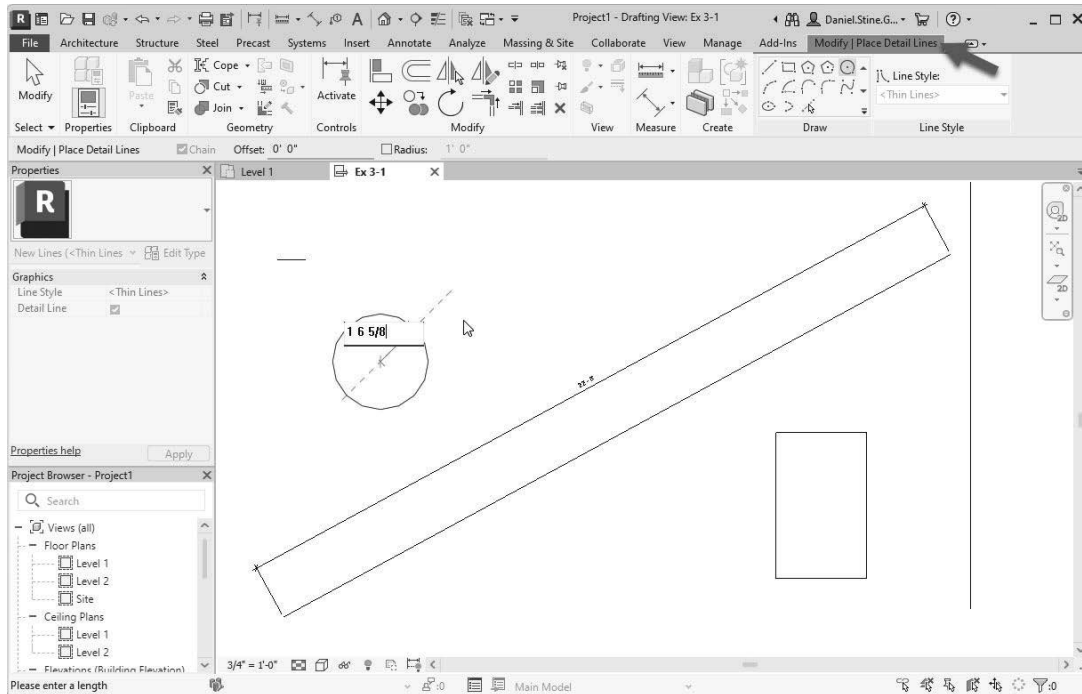

FIGURE 3-1.17 Drawing with Rectangle and Circle added

Notice in the image above, the *Detail Line* is still active because the *contextual tab*, **Modify | Place Detail Lines**, is visible and the *Status Bar* is prompting to “Click to enter circle center.” You need to press **Esc** or click *Modify* to cancel the command; clicking another command will also cancel the current command.

43. **Select the circle** and notice a temporary dimension appears indicating the circle’s radius. Press **Esc** to unselect it (Figure 3-1.18).

TIP: This temporary dimension can be used to change the radius of the circle while the circle is selected.

44. **Save** your project as “**ex3-1.rvt**”.

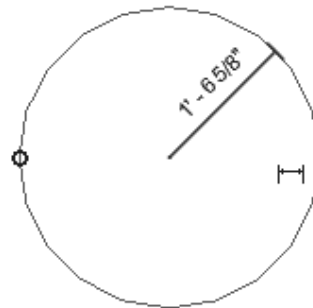

FIGURE 3-1.18
Circle selected

Exercise 3-2:

Snaps

Snaps are tools that allow you to accurately pick a point on an element. For example, when drawing a line you can use *Object Snap* to select, as the start-point, the endpoint or midpoint of another line or wall.

This feature is absolutely critical to drawing accurate technical drawings. Using this feature allows you to be confident you are creating perfect intersections, corners, etc. (Figure 3-2.1).

Object Snaps Options:

You can use *Object Snaps* in one of two ways.

- “Normal” mode
- “Temporary Override” mode

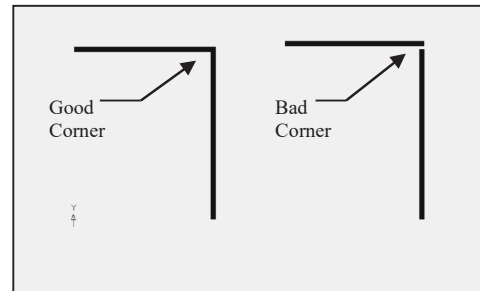

FIGURE 3-2.1 Typical problem when *Snaps* are not used

“Normal” *SNAP* mode is a feature that constantly scans the area near your cursor when Revit is looking for user input. You can configure which types of points to look for.

NOTE: The term “normal” is not a Revit term, rather it is simply a description used in this book to differentiate this portion of the *Snaps* feature from the *Temporary Override* portion discussed next.

Using a “Temporary Override” *Object Snap* for individual pick-points allows you to quickly select a particular point on an element. This option will temporarily disable the other *Object Snap* settings, which means you tell Revit to just look for the endpoint on an object, for the next pick-point only, rather than the three or four types being scanned for by the “normal” *Object Snaps* feature.

Overview of the Snaps Dialog Box:

Revit provides a *Snaps* dialog box where you specify which *Object Snaps* you want enabled. Next you will take a look at it.

1. Open project **Ex3-1** and select **Manage** → **Settings** → **Snaps**.



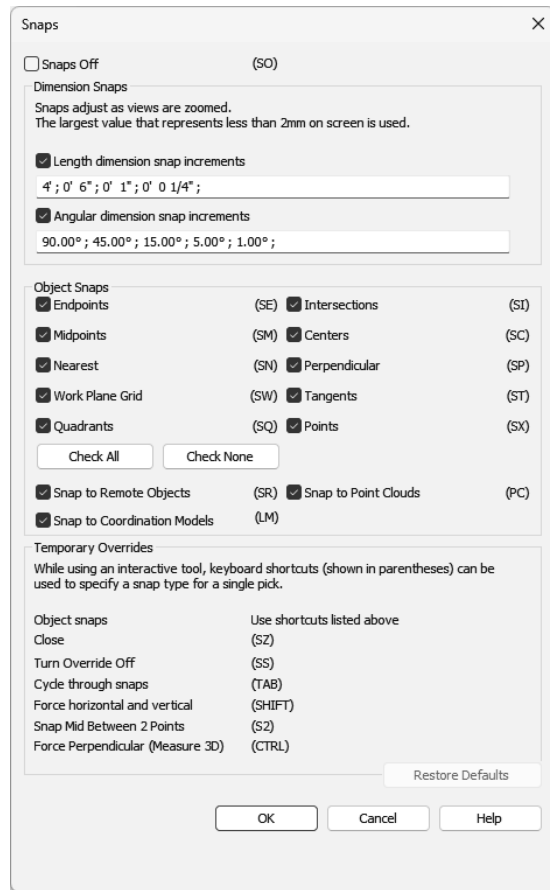

FIGURE 3-2.2 Snaps dialog box; default settings

You should now see the *Snaps* dialog box (Figure 3-2.2). Take a minute to study the various settings that you can control with this dialog box. Notice the check box at the top that allows you to turn this feature off completely.

Dimension Snaps

This controls the automatic dimensions that Revit suggests when you are drawing. Following the given format you could add or remove increments. If you are zoomed in close, only the smaller increments are used.

Object Snaps

This controls the “normal” *Object Snaps* that Revit scans for while you are drawing. Unchecking an item tells Revit not to scan for it anymore. Currently, all *Object Snaps* are enabled (Figure 3-2.2).

Temporary Overrides

This area is really just information on how to use Temporary Overrides.

While drawing you will occasionally want to tell Revit you only want to *Snap* to an Endpoint for the next pick. Instead of opening the *Snaps* dialog and un-checking every *Object Snap* except for Endpoint, you can specify a *Temporary Override* for the next pick. You do this by typing the two letters, in parentheses, in the *Object Snaps* area of the *Snaps* dialog (Figure 3-2.2).

2. Make sure the *Snaps Off* option is unchecked in the upper-left corner of the dialog box; this turns Snaps completely off.
3. Click on the **Check All** button to make sure all *Snaps* are checked.
4. Click **OK** to close the *Snaps* dialog box.

Understanding Snap Symbols:

Again, you should be well aware of the *Object Snap* symbols that Revit displays as you move your cursor about the drawing window while you are in a tool like *Wall* and Revit is awaiting your input or pick-point.

If you hold your cursor still for a moment, while a snap symbol is displayed, a tooltip will appear on the screen. However, when you become familiar with the snap symbols you can pick sooner, rather than waiting for the tooltip to display (Figure 3-2.3).

The TAB key cycles through the available snaps near your cursor.

Symbol	Position	Keyboard Shortcut
✕	Intersection	SI
□	Endpoint	SE
△	Midpoint	SM
○	Center	SC
✕	Nearest	SN
⊥	Perpendicular	SP
○	Tangent	ST

FIGURE 3-2.3 Snap symbols

Finally, typing **SO** turns all snaps off for one pick.

FYI: The Snaps shown in Figure 3-2.2 are for Revit in general, not just the current project. This is convenient; you don't have to adjust to your favorite settings for each Project or View, existing or new.

Setting Object Snaps:

You can set Revit to have just one or all Snaps running at the same time. Let us say you have Endpoint and Midpoint set to be running. While using the *Wall* tool, you move your cursor near an existing wall. When the cursor is near the end of the wall you will see the Endpoint symbol show up; when you move the cursor towards the middle of the line you will see the Midpoint symbol show up.

The next step shows you how to tell Revit which Object Snaps you want it to look for. First you will save a new copy of your project.

5. Select **File Tab** → **Save-As** → **Project**.
6. Name the project **ex3-2.rvt**.
7. As discussed previously, open the *Snaps* dialog box.
8. Make sure only the following *Snaps* are checked:
 - a. Endpoints
 - b. Midpoints
 - c. Centers
 - d. Intersections
 - e. Perpendicular

- Click **OK** to close the dialog box.

For More Information:

For more on using Snaps, search Revit's *Help System* for **Snaps**. Then double-click **Snap Points** or any other items found by the search.

Now that you have the *Snaps* adjusted, you will give this feature a try.

- Using the **Detail Line** tool, move your cursor to the lower-left portion of the diagonal line (Figure 3-2.4).

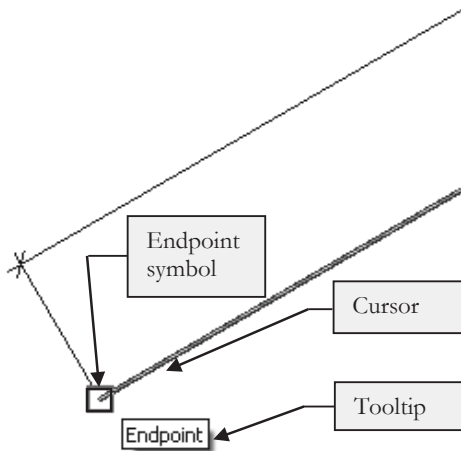

- Hover the cursor over the line's endpoint (without picking); when you see the *Endpoint* symbol you can click to select that point.

Just So You Know

It is important that you see the *SNAP* symbol before clicking. Also, once you see the symbol you should be careful not to move the mouse too much.

These steps will help to ensure accurate selections.

FIGURE 3-2.4 Endpoint SNAP symbol visible

While still in the **Detail Line** tool you will draw lines using *Snaps* to sketch accurately.

- Draw the additional lines shown in **Figure 3-2.5** using the appropriate *Object Snap*, changing the selected Snaps as required to select the required points.

TIP #1: At any point while the *Line* tool is active, you can open the *SNAP* dialog box and adjust its settings. This will not cancel the *Line* command.

TIP #2: Also, remember you can press *Tab* to cycle through the various snap options below or near your cursor.

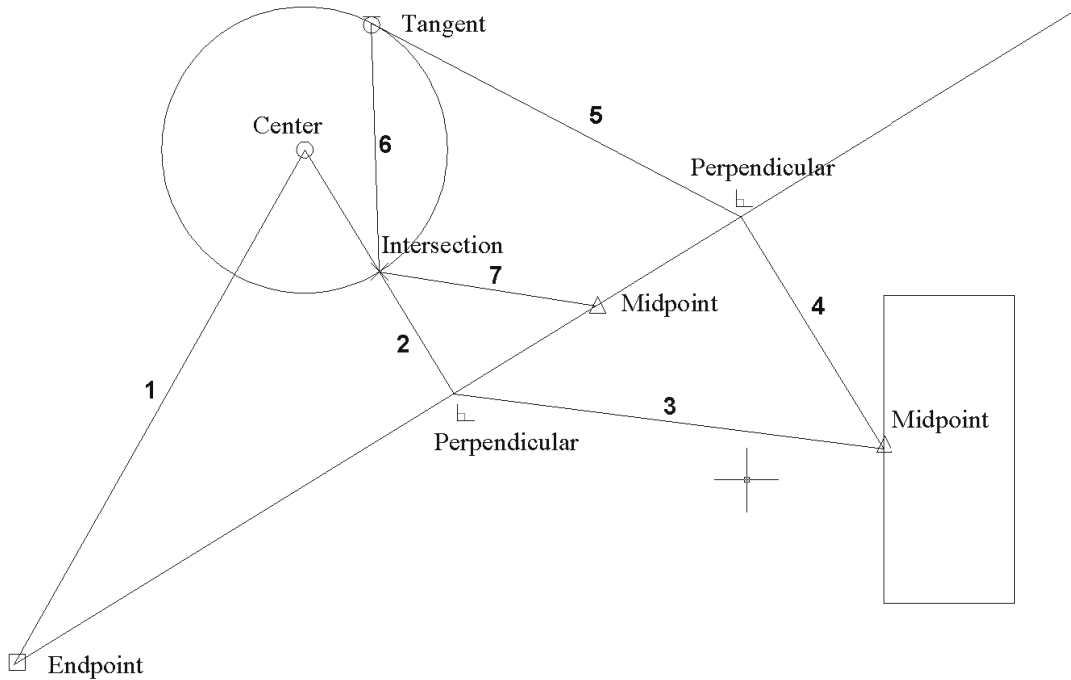

FIGURE 3-2.5 Lines to draw and Snap to use

13. **Save** your project.

Your drawing might look slightly different depending on where you drew the rectangle and circle in the previous steps.

This is a Residential Example?

OK, this is not really an architectural example yet. However, the point here is to focus on the fundamental concepts and not architecture just yet.

Save Reminders:

Revit is configured to remind you to save every 30 minutes so you do not lose any work (Figure 3-2.6).

It is recommended that you do not simply click *Cancel*, but do click the **Save the project** option.

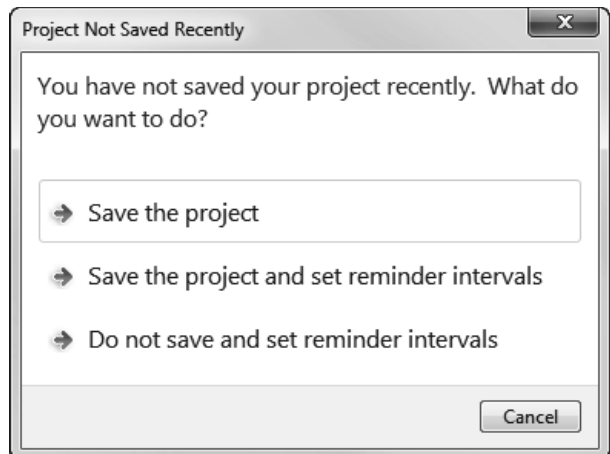

FIGURE 3-2.6 Save reminder

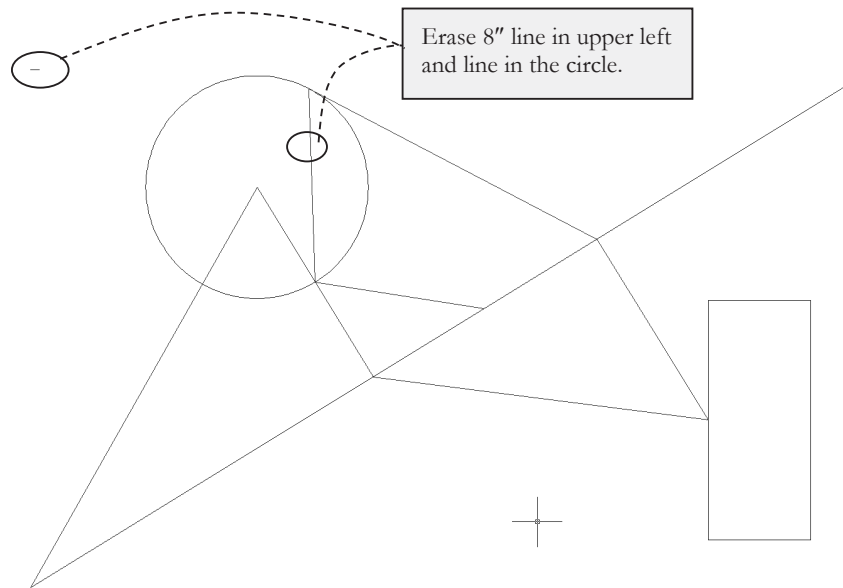

FIGURE 3-3.2 Lines to be erased

Selecting Objects:

At this time we will digress and take a quick look at the various techniques for selecting entities in Revit. Most tools work the same when it comes to selecting elements.

When selecting entities, you have two primary ways to select them:

- Individually select entities one at a time
- Select several entities at a time with a window

You can use one or a combination of both methods to select elements when using the *Copy* tool.

Individual Selections:

When prompted to select entities to copy or delete, for example, you simply move the cursor over the element and click; holding the **Ctrl** key you can select multiple objects. Then you typically click the tool you wish to use on the selected items. Press **Shift** and click on an item to subtract it from the current selection set.

Continued on next page

Window Selections:

Similarly, you can pick a *window* around several elements to select them all at once. To select a *window*, rather than selecting an object as previously described, you select one corner of the *window* you wish to define. That is, you pick a point in “space” and hold the mouse button down. Now, as you move the mouse you will see a rectangle on the screen that represents the windowed area you are selecting; when the *window* encompasses the elements you wish to select, release the mouse.

You actually have two types of windows you can select. One is called a **window** and the other is called a **crossing window**.

Window:

This option allows you to select only the objects that are completely within the *window*. Any lines that extend out of the *window* are not selected.

Crossing Window:

This option allows you to select all the entities that are completely within the *window* and any that extend outside the *window*.

Using Window versus Crossing Window:

To select a *window* you simply pick and drag from left to right to form a rectangle (Figure 3-3.3a).

Conversely, to select a *crossing window*, you pick and drag from right to left to define the two diagonal points of the window (Figure 3-3.3b).

Selecting a chain of lines (hover, tab, click):

Revit provides a quick and easy way to select a chain of lines, that is, a series of lines (or walls) whose endpoints are perfectly connected. You simply hover your cursor over one line so it highlights, then press the Tab key once, and then click the mouse button. This trick can be used to quickly select all the exterior walls on a building, for example.

Turning off **Drag Element on Selection** on the *Status Bar* helps to avoid accidentally clicking directly on an element and moving it rather than starting the intended first corner of a selection window.

Remember, all these draw, modify and select tools have direct application to working with Revit’s 3D building components, not just the 2D geometry being covered in this chapter.

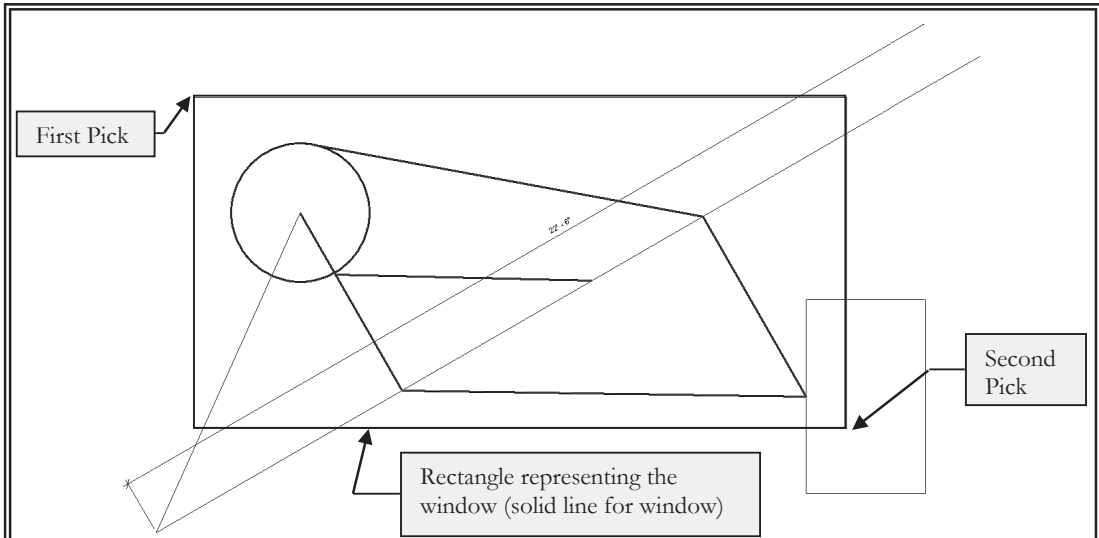

FIGURE 3-3.3A Six items selected using *window*; only the lines completely within the window are selected.

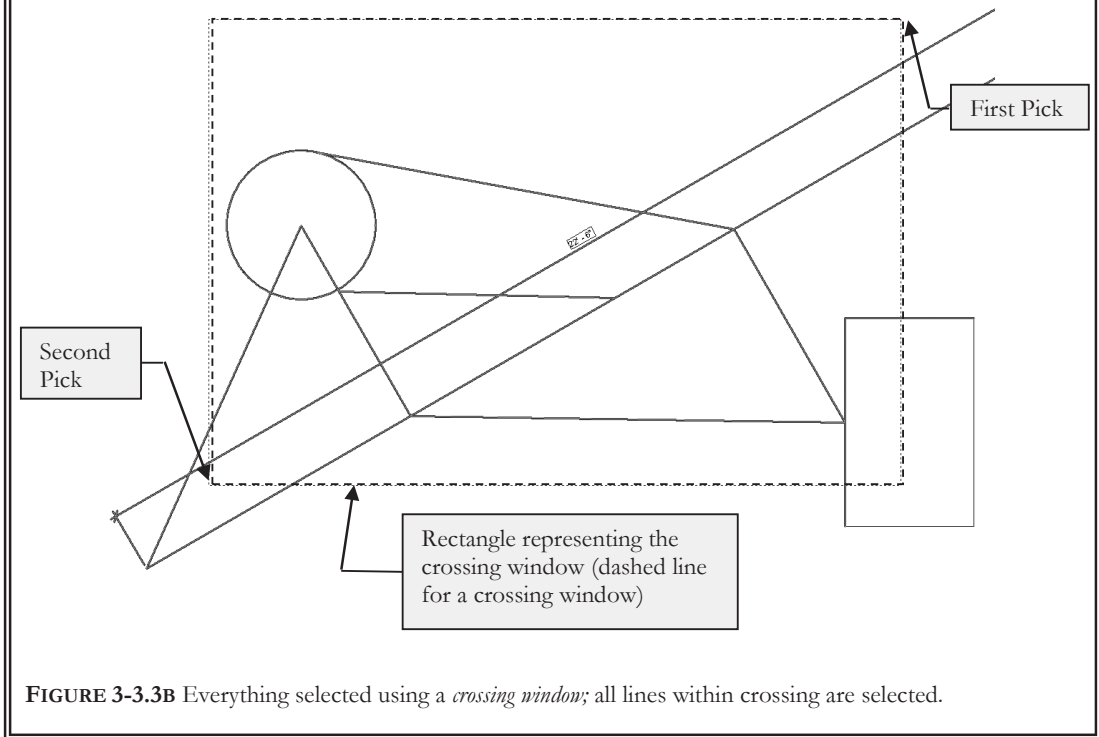

FIGURE 3-3.3B Everything selected using a *crossing window*; all lines within crossing are selected.

Copy Tool:

The *Copy* tool allows you to accurately duplicate an element(s). You select the items you want to copy and then pick two points that represent an imaginary vector, which provides both length and angle, defining the path used to copy the object. You can also type in the length if there are no convenient points to pick in the drawing. You will try both methods next.

5. Select the circle.



6. Select **Copy** from the *Ribbon*.

Notice the prompt on the Status Bar: Click to enter move start point.

7. Pick the **center** of the **circle** (Figure 3-3.4).

FYI: You actually have three different Snaps you can use here: Center, Endpoint and Intersection. All occur at the exact same point.

Notice the prompt on the Status Bar: Click to enter move end point.

8. Pick the **endpoint** of the angled line in the lower left corner (Figure 3-3.4).

FYI: If you want to make several copies of the circle, select **Multiple** on the Options Bar.

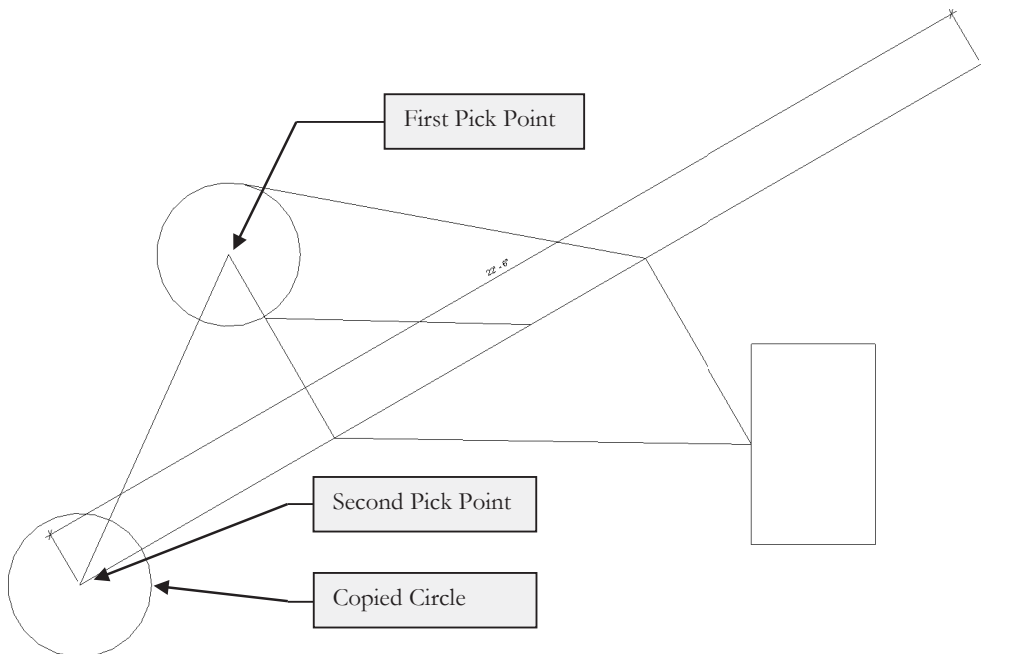

FIGURE 3-3.4 Copied circle; also indicates points selected

9. **Select the rectangle** (*all four lines*).

TIP: Try the “*hover, tab, click*” method discussed on page 3-22.

10. Select **Copy**.

11. Pick an arbitrary point on the screen. In this scenario it makes no difference where you pick; you will see why in a moment.

At this point you will move the mouse in the direction you want to copy the rectangle, until the correct angle is displayed, and then type in the distance rather than picking a second point on the screen.

12. Move the mouse towards the upper right until 45 degrees displays, then type **6'** and then press **Enter** (Figure 3-3.5).

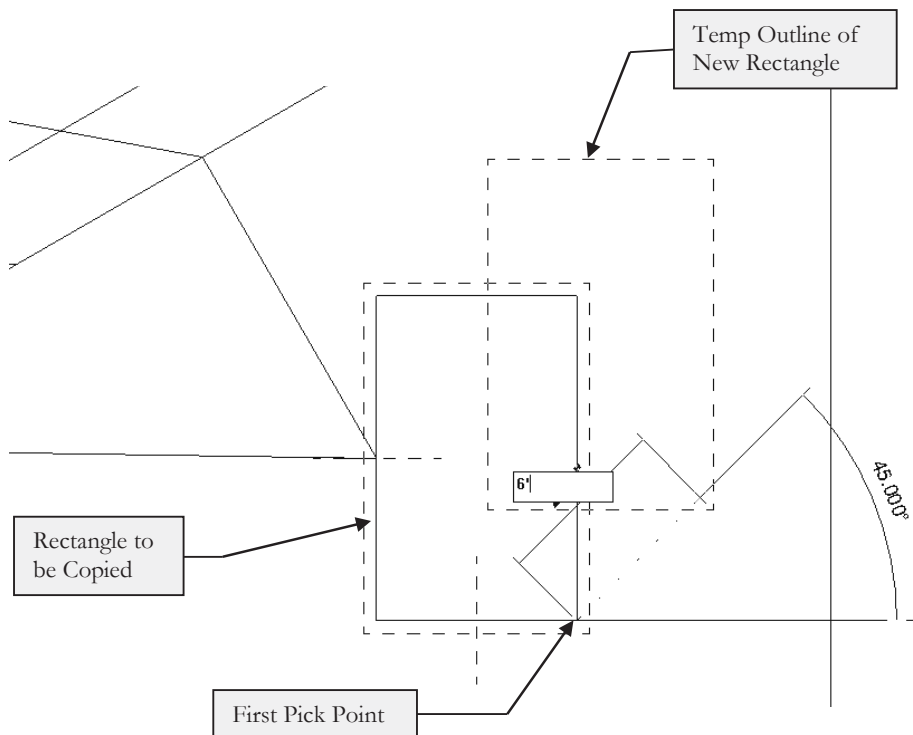

FIGURE 3-3.5 Copying rectangle; angle set visually and distance typed in

NOTE: Your drawing may look a little different than this one because your drawing is not completely to scale.

Move Tool:

The *Move* tool works exactly like the *Copy* tool except, of course, you move the element(s) rather than copy it. Given the similarity to the previous tool covered, the *Move* tool will not be covered now. You are encouraged to try it yourself; just Undo your experiments before proceeding.



Rotate Tool:

With the *Rotate* tool, you can arbitrarily or accurately rotate one or more objects in your drawing. When you need to rotate accurately, you can pick points that define the angle, assuming points exist in the drawing to pick, or you can type a specific angle.

Rotate involves the following steps:

- Select element(s) to be rotated
- Select *Rotate*
- Determine if the Center of Rotation symbol is where you want it.
 - If you want to move it:
 - Simply drag it, or
 - Click *Place* on the *Options Bar*
- Select a point to define a reference line and begin rotation.
- Pick a second point using one of the following methods:
 - By selecting other objects or using the graphic angle display *or*
 - You can type an angle and press **Enter**.

13. **Select the new rectangle** you just copied (*all four lines*).

14. Select **Rotate** on the *Ribbon*.



Notice that the “Center of Rotation” grip, by default, is located in the center of the selected elements. This is the point about which the rotation will occur. See Figure 3-3.6.

You will not change the “Center of Rotation” at this time.

15. Pick a point directly to the right of the “Center of Rotation” grip; this tells Revit you want to rotate the rectangle relative to the horizontal plane (Figure 3-3.6).

Now, as you move your mouse up or down, you will see the temporary angle dimension displayed. You can move the mouse until the desired angle is displayed and then click to complete the rotation, or you can type the desired angle and then press **Enter**. If you recall, the *Snaps* dialog box controls the increments of the angles that Revit displays; they are all whole numbers. So if you need to rotate something 22.45 degrees, you must type it as Revit will never display that number as an option.

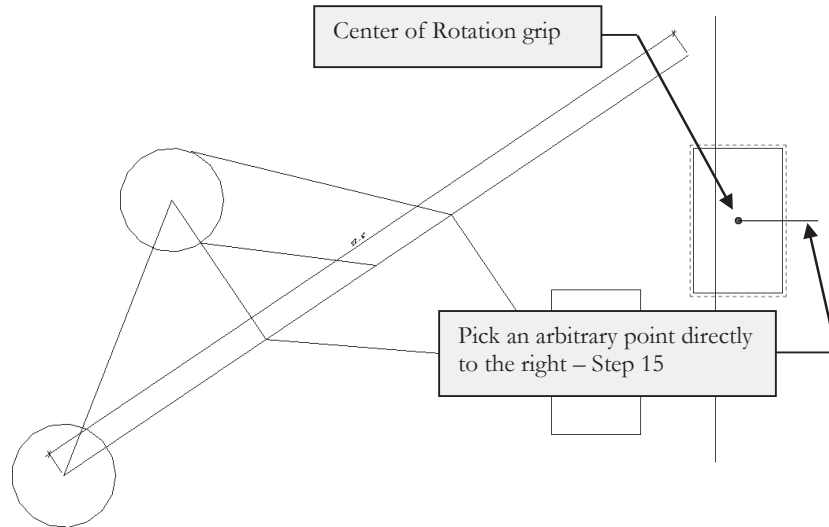

FIGURE 3-3.6 Rotate tool; first step – select lines and then click Rotate

16. Move the mouse up and to the left until 90 degrees is displayed and then click to complete the rotation (Figure 3-3.7).

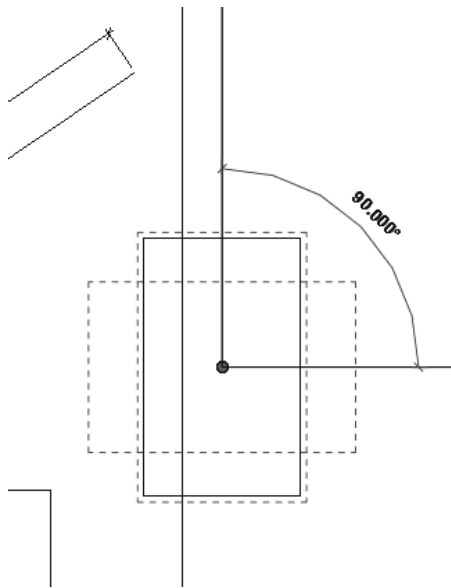

FIGURE 3-3.7 Rotate tool; last step – select angle visually or type angle

The previous steps just rotated the rectangle 90 degrees counter-clockwise about its center point (Figure 3-3.8).

17. Select the **Undo** icon. 

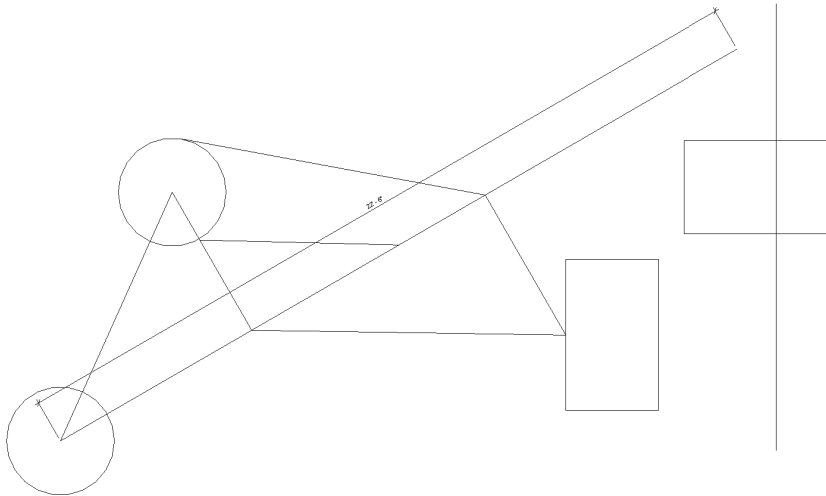

FIGURE 3-3.8 Rotate tool; rectangle rotated about its center point

Now you will do the same thing, except with a different angle and “Center of Rotation.”

18. **Select the rectangle** and then pick **Rotate**.
19. Click and drag the “Center of Rotation” grip to the left and *Snap* to the midpoint of the vertical line (Figure 3-3.9).

TIP: You can also click the **Place** button on the Options Bar.



20. Pick a point to the right, creating a horizontal reference line.
21. Start moving your mouse downward, then type **22.5** and then press **Enter** (Figure 3-3.10).

The rectangle is now rotated 22.5 degrees in the clockwise direction (Figure 3-3.11).

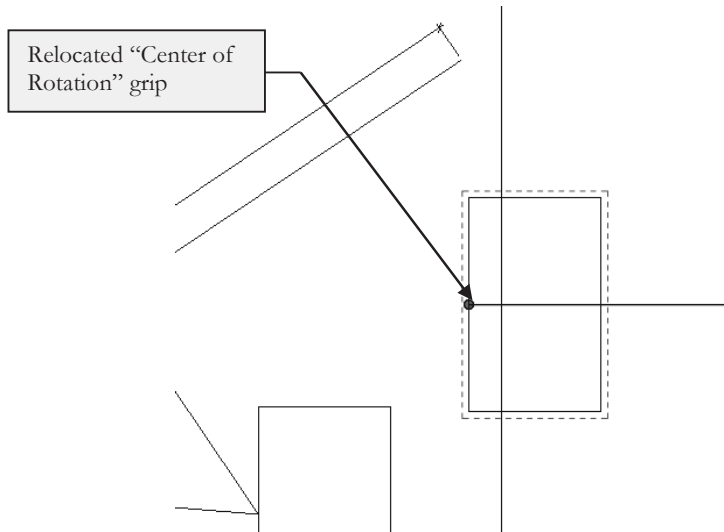

FIGURE 3-3.9 Rotate tool; relocated Center of Rotation grip

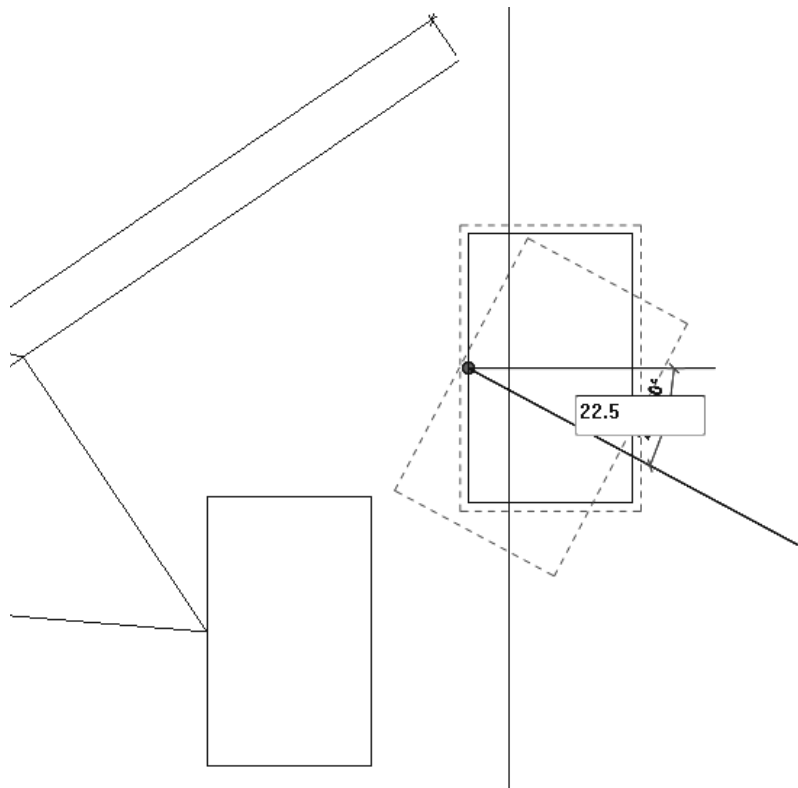

FIGURE 3-3.10 Rotate tool; typing in exact angle

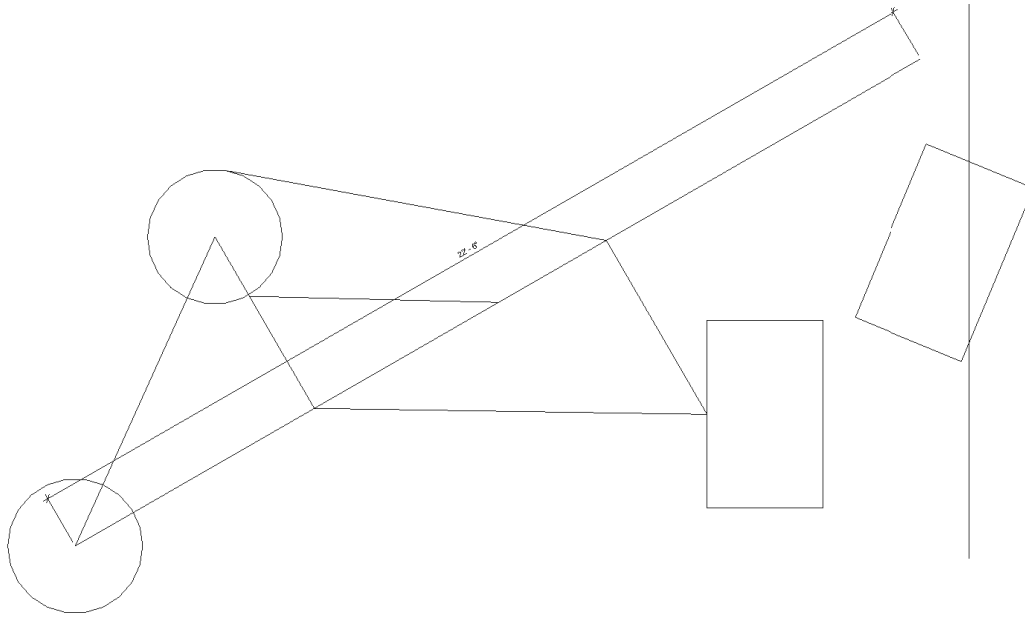

FIGURE 3-3.11 Rotate tool; rectangle rotated 22.5 degrees

Scale Tool:

The *Scale* tool has steps similar to the *Rotate* tool. First you select what you want to scale or resize, specify a scale factor and then you pick the base point. The scale factor can be provided by picks on the screen or entering a numerical scale factor (e.g., 2 or .5, where 2 would be twice the original size and .5 would be half the original size).

Next you will use the *Scale* tool to adjust the size of the circle near the bottom.

Before you resize the circle, you should use the *Modify* tool/mode to note the **diameter** of the circle. Select the circle and view its temporary dimensions. After resizing the circle, you will refer back to the temporary dimensions to note the change. This step is meant to teach you how to verify the accuracy and dimensions of entities in Revit.

22. Select the bottom circle.

23. Select the **Scale** icon from the *Ribbon*.



On the *Options Bar* you will specify a numeric scale factor of .5 to resize the circle to half its original size.

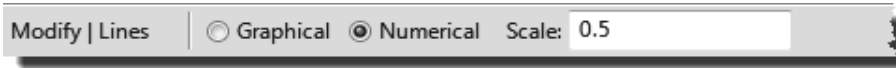

24. Click **Numerical** and then type **.5** in the textbox (*see the Options Bar above*).

You are now prompted **Click to enter origin** on the *Status Bar*. This is the base point about which the circle will be scaled; see examples in Figure 3-3.13 on the next page.

25. Click the center of the circle.

You just used the *Scale* tool to change the size of the circle from 1'-6 5/8" to 9 5/16" radius. A scale factor of .5 reduces the entities to half their original scale (Figure 3-3.12).

Selecting the Correct Center of Rotation (*Base Point*):

You need to select the appropriate *Center of Rotation*, or Base Point, for both the *Scale* and *Rotate* commands to get the results desired. A few examples are shown in Figure 3-3.13. The dashed line indicates the original position of the entity being modified. The black dot indicates the base point selected.

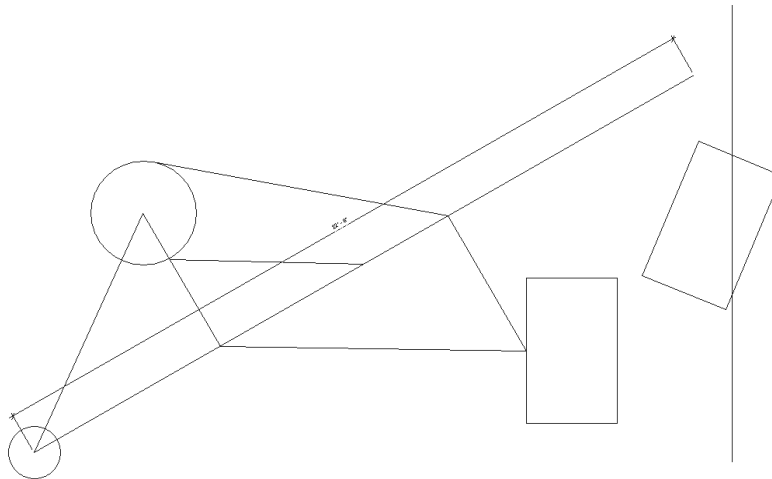

FIGURE 3-3.12 Resize circle; notice it is half the size of the other circle

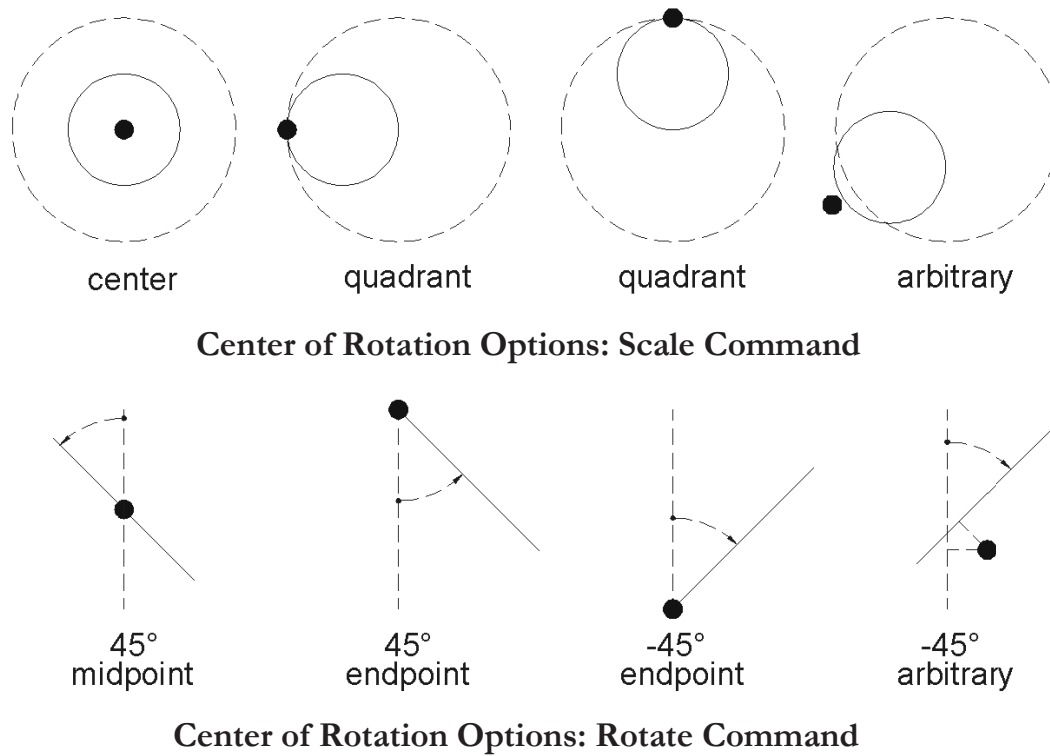

FIGURE 3-3.13 Center of Rotation Options and the various results

This will conclude the brief tour of the *Edit* tools. Do not forget, even though you are editing 2D lines, the edit tools work the same way on 3D elements such as walls, floors, roofs, etc. Exception: you cannot *Scale* walls, doors, etc.; these objects have to be modified by other methods. You would not typically change the door thickness when changing its width and height as would happen if you could use the *Scale* tool on it.

As you surely noticed, the *Modify* panel on the *Ribbon* has a few other tools that have not been investigated yet. Many of these will be covered later in this book.

26. **Save** the project. Your project should already be named “ex3-3.rvt” per Step 2 above.

Exercise 3-4:

Annotations

Annotations, or text and notes, allow the designer and technician to accurately describe the drawing. Here you will take a quick look at this feature set. There is a chapter, later in the book, dedicated to annotation which covers these tools in greater detail.

Annotations:

Adding annotations to a drawing can be as essential as the drawing itself. Often the notes describe a part of the drawing that would be difficult to discern from the drawing alone.

For example, a wall framing drawing showing a bolt may not indicate, graphically, how many bolts are needed or at what spacing. The note might say “5/8” anchor bolt at 24” O.C.”

Next you will add text to your drawing.

1. **Open** project **ex3-3.rvt** from the previous lesson.
2. **Save-As** “**ex3-4.rvt**”.
3. Use **Zoom** if required to see the entire drawing, except for the 600' line which can run off the screen.
4. Select **Annotate** → **Text** → **Text**.

Note that the *Model Text* tool on the *Architecture* tab is only for drawing 3D text; *Drafting Views* are only 2D so that command is not even an option currently.

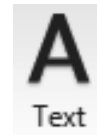

From the *Text* icon tooltip (see image to the right) you can see that the keyboard shortcut for the *Text* tool is **TX**. Thus, at any time you can type T and then X to activate the *Text* tool; if you have another command active, Revit will cancel it.

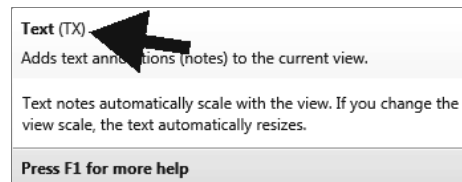

Text icon's tooltip (hover cursor over icon)

Experienced and efficient designers use a combination of keyboard shortcuts and mouse clicks to save time. For example, while your left hand is typing TX, your right hand can be moving toward the location where you want to insert the text. This process is generally more efficient than switching between tabs on the *Ribbon* and clicking icons, or fly-out icons which require yet another click of the mouse.

Notice the current *prompt* on the *Status Bar* at the bottom of the screen; you are asked to “Click to start text or click and drag rectangle to create wrapping text.” By clicking on the screen you create one line of text, starting at the point picked, and press **Enter** to create additional lines. By clicking and dragging a rectangle you specify a window, primarily for the width, which causes Revit to automatically move text to the next line. When the text no longer fits within the window it is pushed below, or what is called “text wrapping” (Figure 3-4.1).

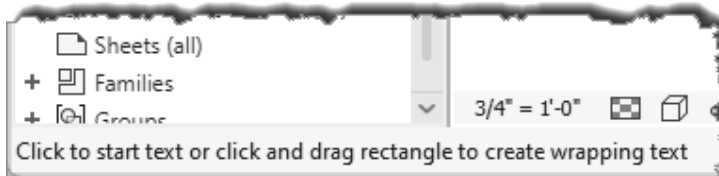

FIGURE 3-4.1 Status Bar while Text tool is active

You should also notice the various text options available on the *Ribbon* while the *Text* tool is active (Figure 3-4.2). You have two text heights loaded from the template file you started with, text justification icons (Left, Center, Right) and the option to attach leaders, or pointing arrows, to your drawings. The *Text* tool will be covered in more detail later in this book.

FYI: The text heights shown (i.e., 1/4", 3/32" via *Type Selector*) are heights the text will be when printed on paper, regardless of the view scale.

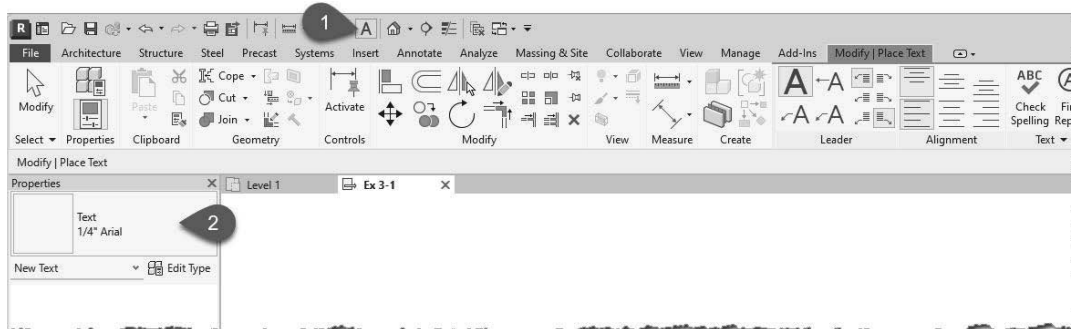

FIGURE 3-4.2 Ribbon and Properties Palette with the Text tool active

5. Pick a point in the upper left portion of the view as shown in Figure 3-4.3.
6. Type “**Learning Revit is fun!**”
7. Click anywhere in the view, except on the active text, to finish the *Text* command; pressing **Enter** will only add new lines.

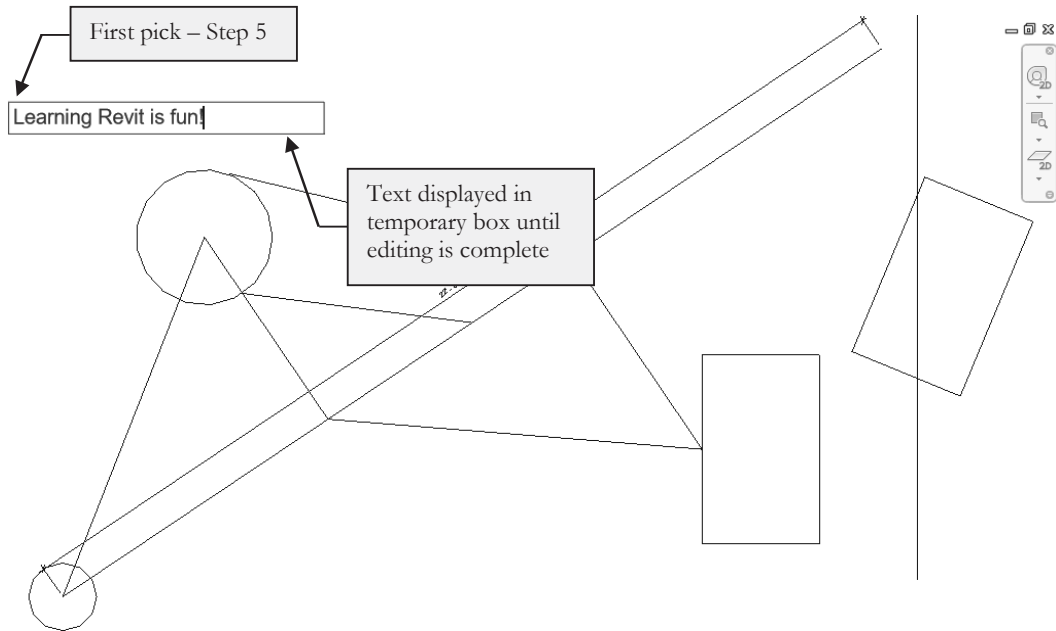

FIGURE 3-4.3 Text tool; picking first point and typing text.

As soon as you complete the text edit, the text will still be selected and the *Move* and *Rotate* symbols will be displayed near the text; this allows you to more quickly *Move* or *Rotate* the text after it is typed (Figure 3-4.4).

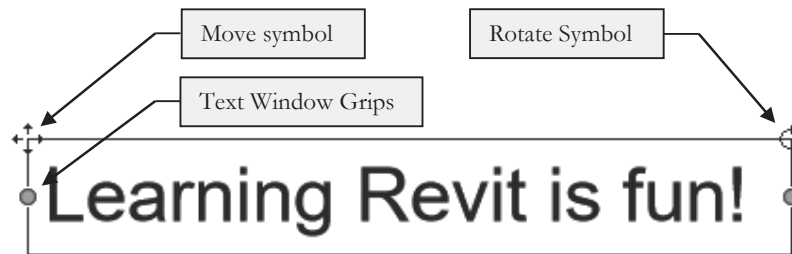

FIGURE 3-4.4 Text tool; text typed with Move and Rotate symbols showing.

8. Finish the *Text* tool completely by pressing *Modify* or clicking in the drawing.

TIP: Notice that the text is no longer selected and the symbols are gone; the contextual tab also disappears on the Ribbon.

Your text should generally look similar to Figure 3-4.5.

9. Print your drawing; refer back to page 2-15 for basic printing information. Your print should fit the page and look similar to Figure 3-4.5.

10. Save your project.

Learning Revit is fun!

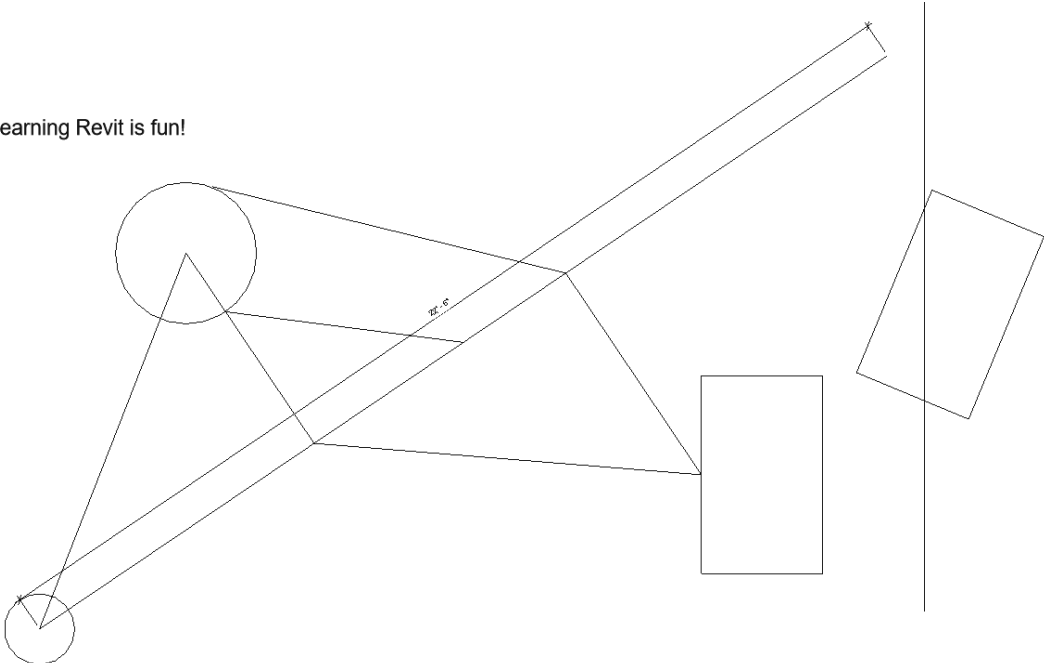

FIGURE 3-4.5 Text tool; text added to current view

Self-Exam:

The following questions can be used as a way to check your knowledge of this lesson. The answers can be found at the bottom of the page.

1. Revit is only accurate to three decimal places. (T/F)
2. The triangular shaped Snap symbol represents the Midpoint snap. (T/F)
3. You can move or rotate text via its modify symbols when text is selected. (T/F)
4. Use the _____ tool to duplicate objects.
5. When selecting objects, use the _____ to select all the objects in the selection window and all objects that extend through it.

Review Questions:

The following questions may be assigned by your instructor as a way to assess your knowledge of this section. Your instructor has the answers to the review questions.

1. Revit is a raster based program. (T/F)
2. The “Center of Rotation” you select for the *Rotate* and *Scale* commands is not important. (T/F)
3. Entering 16 for a distance actually means 16'-0" to Revit. (T/F)
4. Use the *Detail Line* tool, with _____ selected on the *Ribbon*, to create squares.
5. You can change the height of the text from the *Type Selector*. (T/F)
6. Pressing the _____ key cycles you through the snap options.
7. Where do the two predefined text heights come from? _____
8. Specifying degrees with the *Rotate* tool, you must type the number when Revit does not display the number you want; the increments shown on-screen are set in the _____ dialog box.
9. List all the Snap points available on a circle (ex. Line: endpoint, midpoint, nearest): _____.
10. The Snaps Off option must not be checked in the Snaps dialog box to automatically and accurately select snap points while drawing. (T/F)

SELF-EXAM ANSWERS:

1 – F, 2 – T, 3 – T, 4 – Copy, 5 – Crossing Window

Notes: