

# Mastering Surface Modeling with **SOLIDWORKS® 2025**

Basic through Advanced Techniques



Lani Tran, CSWE

Visit the following websites to learn more about this book:



[amazon.com](https://www.amazon.com)

[Google books](https://books.google.com)

[BARNES & NOBLE](https://www.barnesandnoble.com)

# Chapter 1: Introduction to Surfaces

## Solids or Surfaces – What is the difference

### 1. Solids vs. Surfaces:

In SOLIDWORKS, both solids and surfaces are known as Solid Bodies and Surface Bodies. They are advanced tools used to easily create complex geometry. These two entities are very similar and may even be considered the same.

Solid Bodies and Surface Bodies are made up of two types of entities: Geometry and Topology. Geometry represents shapes such as a surface, curve, line, arc, spline, or a point. Topology describes relationships such as a face, an edge, or a vertex, which connects or forms an opened or closed boundary.

The images below display two different objects that appear to be different at first glance. Geometrically they are not quite the same. However, topologically, they are alike. Both objects have eight vertices, six faces, and twelve edges.

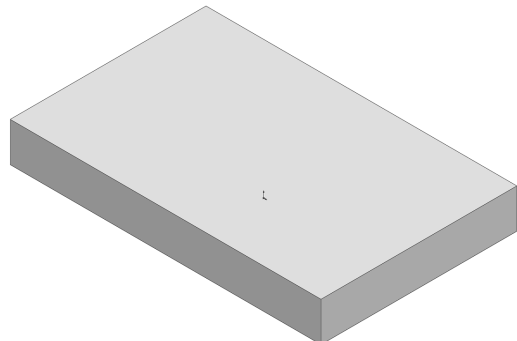
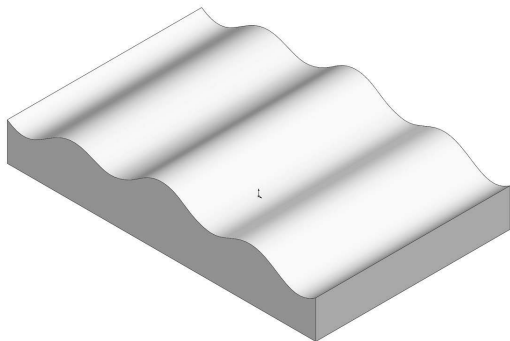

SOLIDWORKS creates surface bodies by forming a mesh of curves called U-V curves. The U curves run along a 4-sided surface and are shown in the magenta color. The curves that run perpendicular to the U curves are called the V Curves, and they are shown in the green color.

Certain commands may offer the preview mesh where these curves are also displayed.

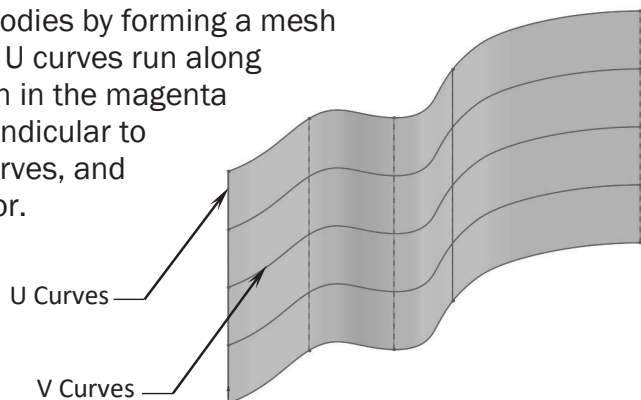

## 2. Patching with continuity:

Blending issues may often arise when creating or patching with surfaces. The three examples below showcase the common examples of patches frequently found in design work.

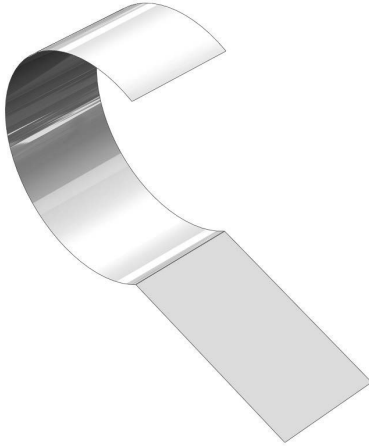

**Contact:** (also called **C0 Continuity**)

The yellow surface is in contact with the gray surface. They both share a common edge.

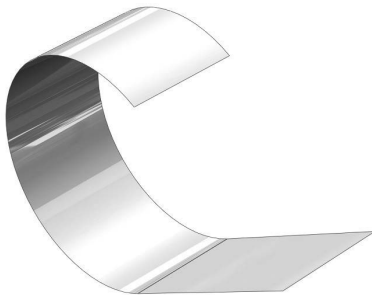
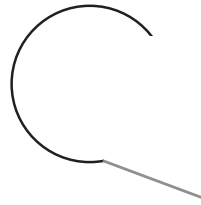

**Tangent:** (also called **C1 Continuity**)

The yellow surface is in contact with the gray surface. They share a common edge and are also tangent to each other.

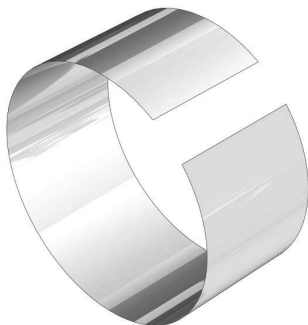
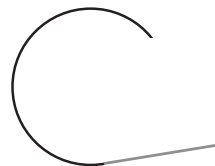

**Curvature Continuous:** (also called **C2 Curvature**)

The yellow surface is in contact with the gray surface. They are tangent and share the same curvature.



Each of the blend types has its own features to assist designers in creating the right patch for a surface model. Though every model may have unique needs, these options will provide a smooth transition between two surfaces.

### 3. When to use surfaces:

Although surface models can be more difficult to create than solid models, solid models may not be enough for all designs. This is where surfacing becomes useful with the important tools to fill in those gaps.

When determining whether to use solid features or surface features, it is helpful to remember that shapes which can be easily made with the Extrude, Sweep, or Loft commands should be made as solid features. These shapes will frequently require more than one side to be created at the same time while residing within the same feature.

A surface model, on the other hand, is created by constructing one surface at a time. This way, different methods and techniques may be used to create the surfaces, one side at a time. The surface model shown on the right is a primary example of an instance where surfaces should be used.



Surfaces can be used as reference geometry in order to assist with the construction of a model. The surfaces will then be moved into a Surface Bodies folder and become hidden when the model is complete.

### 4. When not to use surfaces:

Shapes that can be created as one feature along one direction, such as blocks and cylinders, should be made as solid features.

Solid features take less time to make. Generally, the final design of a model should be a solid model. This is because a solid model can have a material assigned to it, can be analyzed to simulate future issues, and can be used to create production drawings.

It is the best practice to combine both solid and surfacing tools (Hybrid Modeling) in order to take advantage of all the tools available and use SOLIDWORKS' powerful features to their fullest extent.

## 5. The Spline handles:

When creating the surfaces, the Spline tool is often used to create complex curves. This is because it can produce a higher quality curve than other available tools.

Spline can be modified using several controls, including spline points, spline handles, and control polygons. A single spline can have multiple through points and spans (the region between through points). Further, curvature constraints can be applied at each endpoint. At each through point, the tangency vector may be weighed and the tangency direction controlled.

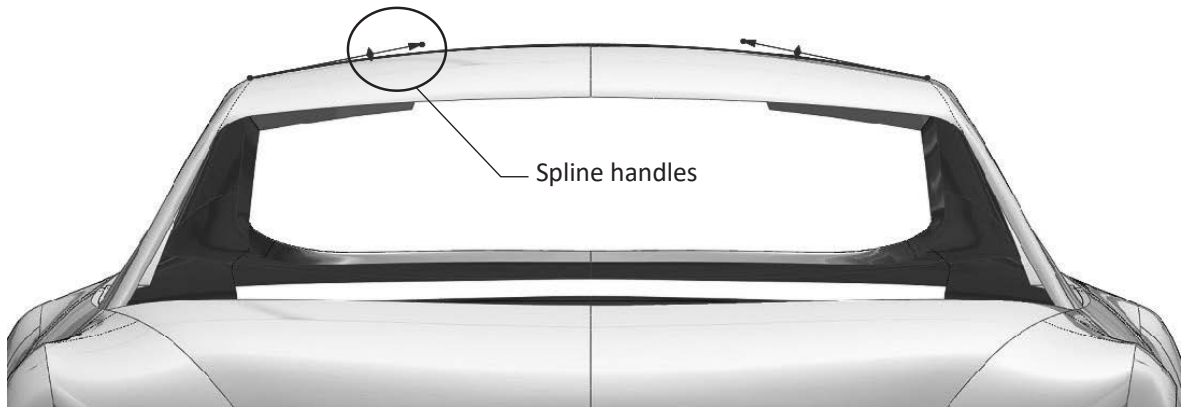

Each Spline includes a set of tools to assist with the manipulation of its curvature. These tools are:

- \* Curvature Combs
- \* Spline Handles
- \* Inflection Points
- \* Control Polygons

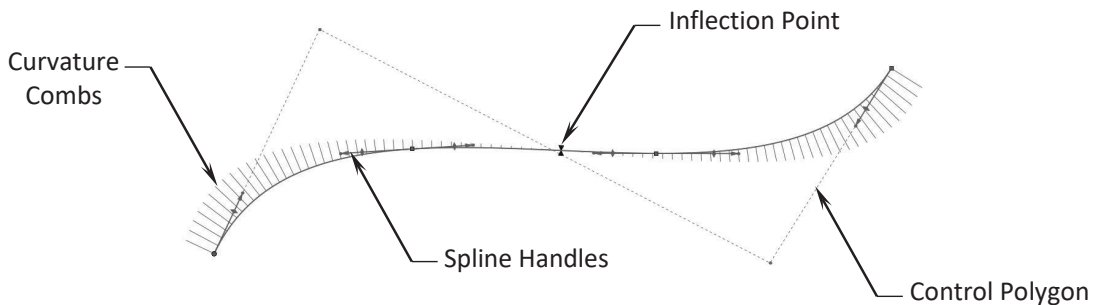
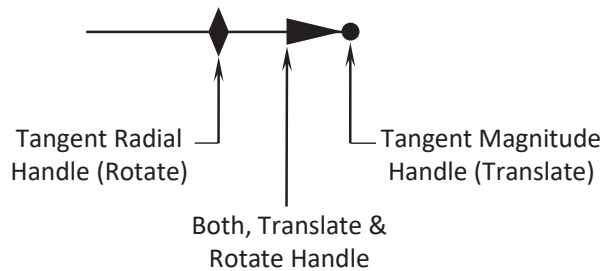

## 6. Check your surface model frequently:

Unlike solid features in which one feature may have multiple sides (i.e. an extruded block has six sides, extruded in one direction), surface models are created one face at a time in order to complete each side of the model. Further, surface models are not frequently verified as solid features.

These surfaces may have small gaps or overlapping elements that are difficult to spot. Therefore, it is important to check your surface model for errors after each feature is built.

The Check (or Check Entity) command, under the Evaluate tab, functions as a tool to check surface models and identify geometry issues. If gaps or overlaps exist in the model, the system will prevent the surfaces from knitting into a solid model. It is the best practice to check your model often to reveal any errors.

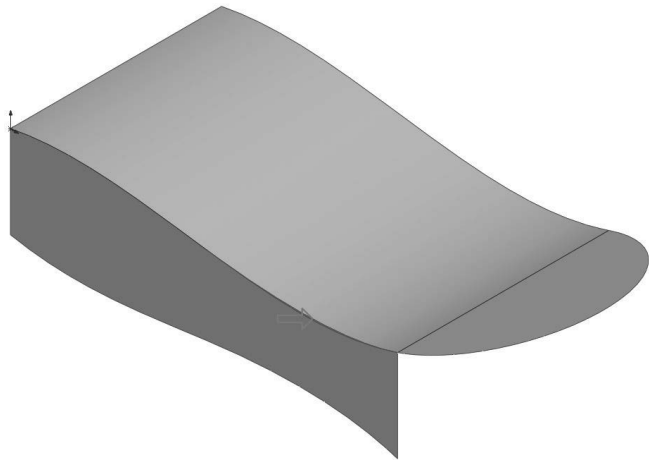
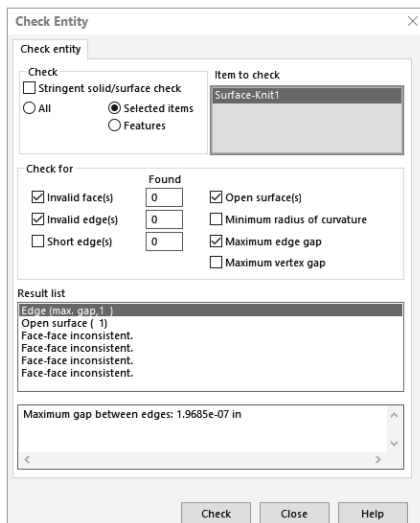

Shortcuts (or hotkeys) are often used to regenerate the surface models.

The hotkeys **Control+B** will rebuild only the new features and their related children, while **Control+Q** will force a complete rebuild of all features in the model.

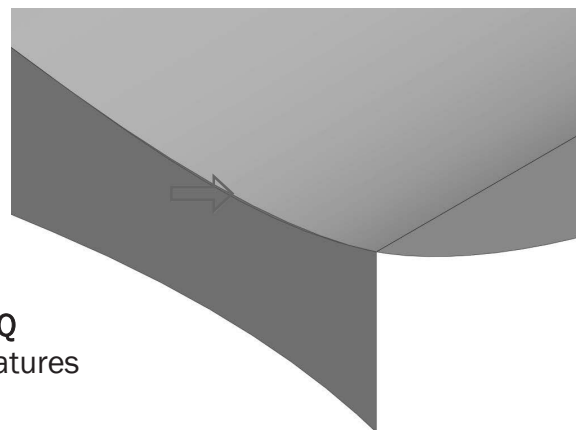

## 7. The best approach:

Combining solid and surface tools is the best approach to creating your model. Fully utilizing the collaboration of these tools allows for complex geometry and the optimization of different techniques. Techniques such as using a surface to trim a solid, replacing a surface with different surface, or splitting a solid body into multiple solid bodies, can be necessary to finalize a model.

This unique approach is called Hybrid Modeling, which is a preferred method for most advanced SOLIDWORKS users. The approach, along with other techniques, will be discussed throughout this book when creating the surface models covered in these lessons.

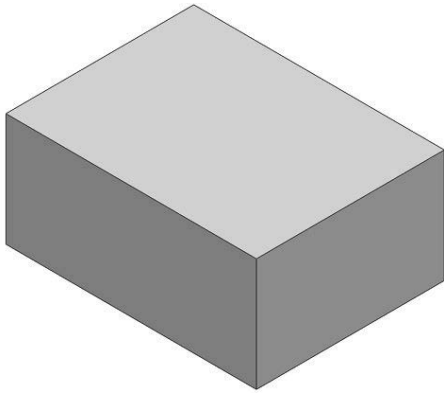

A few important factors to keep in mind from this chapter as we progress through the proceeding lessons:

Solid features are more efficient to use on simple shapes and models. Surface features should be used for complex shapes and models.

Surface features take longer to construct and should be checked frequently for errors.

After all surfaces are created, they should be knitted into one enclosed volume then thickened into a solid model. By turning the surface model into a solid model, we can now analyze for potential issues and create drawings.

