

Autodesk®

# Maya® 2027 Basics Guide

TEXT AND VIDEO INSTRUCTION

**Videos**  
Includes Video Tutorials



Kelly L. Murdock



Better Textbooks. Lower Prices.  
[www.SDCpublications.com](http://www.SDCpublications.com)



**ACCESS CODE**  
UNIQUE CODE INSIDE

Visit the following websites to learn more about this book:



[amazon.com](https://www.amazon.com)

[Google books](https://books.google.com)

[BARNES & NOBLE](https://www.barnesandnoble.com)

# Chapter 1

## Learning the Maya Interface

### IN THIS CHAPTER

- 1.1 Work with menus.
- 1.2 Use the Status Line buttons.
- 1.3 Access the Shelf.
- 1.4 Explore the Channel Box and Layer Editor.
- 1.5 Identify the animation controls, the Command Line, and the Help Line.
- 1.6 Use the Toolbox buttons.
- 1.7 Discover the marking menus.
- 1.8 Get Help

Maya is a program, created by Autodesk, used to model, animate, and render 3D scenes. 3D scenes created with Maya have appeared in movies, television, advertisements, games, product visualizations, and on the Web. With Maya, you can create and animate your own 3D scenes and render them as still images or as animation sequences.

Several versions of Maya exist and the difference between them lies in the features that are included in each. The commercial version of Maya includes everything you need to create and render 3D scenes and animations. Maya is also available in the Media and Entertainment Collection, which pairs it with other Autodesk products including Arnold, Mudbox and 3ds Max. Student versions are also available at a reduced cost.

At first glance, the Maya interface can be a little daunting, with buttons, controls, and parameters everywhere, but if you look closer, you'll realize that all of the controls are grouped into logical sets. Becoming familiar with these various sets of controls makes the interface much easier to work with.

Along the top edge of the interface are the menus and a toolbar of buttons called the **Status Line**. The menus will change depending on the mode that you're working in. Below the Status Line is a tabbed row of buttons. This row of buttons is called the **Shelf**, and it offers a convenient way to group sets of commands together. To the right of the interface is a panel of parameters called the **Channel Box**. These parameters, known as attributes, will change as different objects are selected. Under the Channel Box is the **Layer Editor**.

Along the bottom of the interface are the Time Slider, the Range Slider, and the animation controls, which are used to specify and move between the different frames of an animation sequence; also at the bottom are the **Command Line**, for entering textual commands, and the **Help Line**. Finally, the horizontal column of buttons to the left of the interface is known as the **Toolbox buttons**. These buttons are used to select and transform scene objects.

A key concept that you need to understand as you begin to work with the interface is that there are several ways to access the same command. For example, you can create a sphere using the Create, Polygon Primitives, Sphere menu command or by using the Polygon Sphere button in the Poly Modeling shelf. This design is intentional, allowing beginners an intuitive method for accessing a command, and giving advanced users an access method that lets them work quicker as they learn the shortcuts.

One of the quickest ways to access advanced-user commands is with the pop-up menus. These context-specific menus appear when you right-click in the interface. Another quick way to access commands is with keyboard shortcuts, known as **hotkeys**.

Maya gives users the option to customize the interface. Using the customization features, you can create a custom set of command icons, define keyboard shortcuts, and even alter menus. Many of the customization options are included in the Windows, Settings/Preferences menu.

There are several help features in Maya that can be used to quickly find a specific command. These include the Help menu, the Search feature and Autodesk Assistant.

## Lesson 1.1: Work with Menus

The main menu commands are the first place you should look for commands when you're new to Maya. The commands are listed as text, making them easier to find until you learn what the various buttons do. Each menu can include several submenus. Submenus are identified by a small, right-pointing arrow at the right end of the menu.

### Changing Menu Sets

The menus are dynamic and change depending on the **menu set** that is selected. You can change between the menu sets using the drop-down list that is to the very left of the Status Line, as shown in Figure 1-1. The options include Modeling, Rigging, Animation, FX, Rendering and an option to Customize the menu set drop-down list.

#### Tip

Each of the menu sets has an associated hotkey. These hotkeys are F2 for Modeling, F3 for Rigging, F4 for Animation, F5 for FX, and F6 for Rendering.

The first six menu commands: File, Edit, Create, Select, Modify, Display, and Window, are available in all menu sets. The remaining menus will change as the menu set is changed.

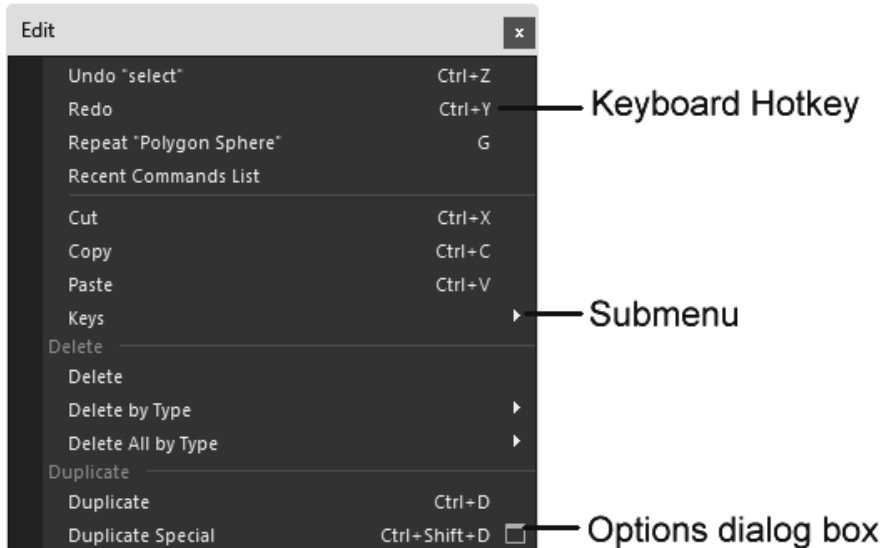

FIGURE 1-1

Menu set selection list

## Viewing Keyboard Hotkeys

Several menu commands have a keyboard hotkey listed to the right of the menu, as shown in Figure 1-2. Pressing these hotkeys on the keyboard executes the command. Hotkeys provide a quick and easy way to execute a command, and learning to use them will make you much more efficient. You can customize hotkeys using the Hotkey Editor, which you open with the Windows, Settings/Preferences, Hotkey Editor menu command.

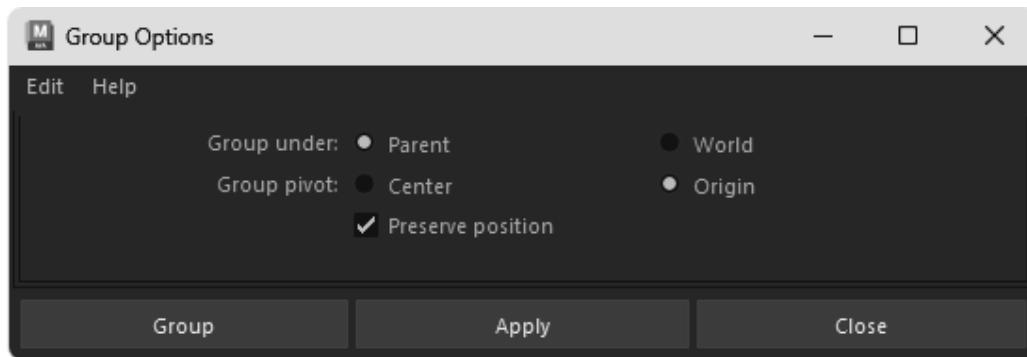

**FIGURE 1-2**

Hotkeys and option dialog boxes are displayed in the menus

## Accessing Option Dialog Boxes

Several menus also include a small box icon to the right of the menu, also shown in Figure 1-2. These box icons will open an Options dialog box for the selected command. These Options dialog boxes, such as the Group Options dialog box shown in Figure 1-3, include parameters that you can change. Clicking the operation name button, such as Group, runs the command with the given parameters. The Close button closes the Options dialog box without applying any changes. Options dialog boxes also include Apply buttons that let you apply the command with the given parameters without closing the dialog box. Using the Apply button, you can execute the command many times without having to reopen the dialog box. The **option dialog box** values are persistent. Any values that are changed will maintain their setting the next time the command is used. You can reset an options dialog box to its default values using the Edit, Reset Settings menu command in the dialog box menu.



**FIGURE 1-3**

The Group Options dialog box

---

## Using Tear-Off Menus

At the very top of most menus is a double line called the **tear-off menu**. Clicking on this line makes the menu a tear-off menu and displays it as a separate panel, like the one shown in Figure 1-4, that you can move about by dragging on its title bar. Tear-off menus are convenient because they make the menu commands accessible with one click, but you need the space to leave the tear-off menu open without covering something else. You can close an opened tear-off menu by clicking on the X button in the upper right corner.

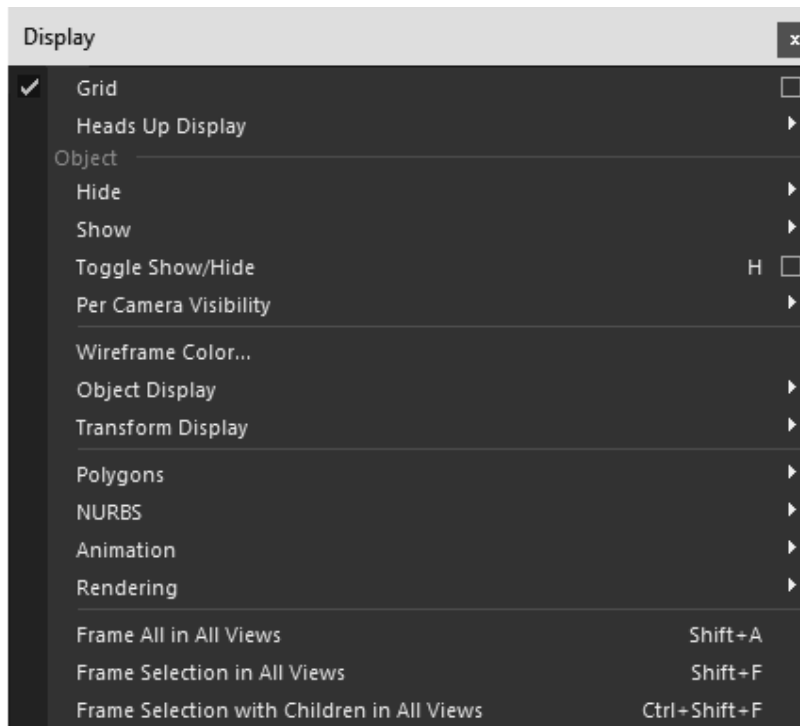
**FIGURE 1-4**

Tear-off menu

## Understanding Tools versus Actions

If you peruse the menus, you'll see many commands that end in the word *Tool*. Tools, when selected, are active until another tool is selected, but actions are only executed once. The last tool used is displayed at the bottom of the **Toolbox** for easy re-selection. Double-clicking a tool's button will open the Tool Settings dialog box, as shown for the Move tool in Figure 1-5. You can also open the Tool Settings using the Show/Hide Tool Settings button at the right end of the Status Line. Tool settings are also persistent and can be reset using the Reset Tool button at the top of the Tool Settings interface.

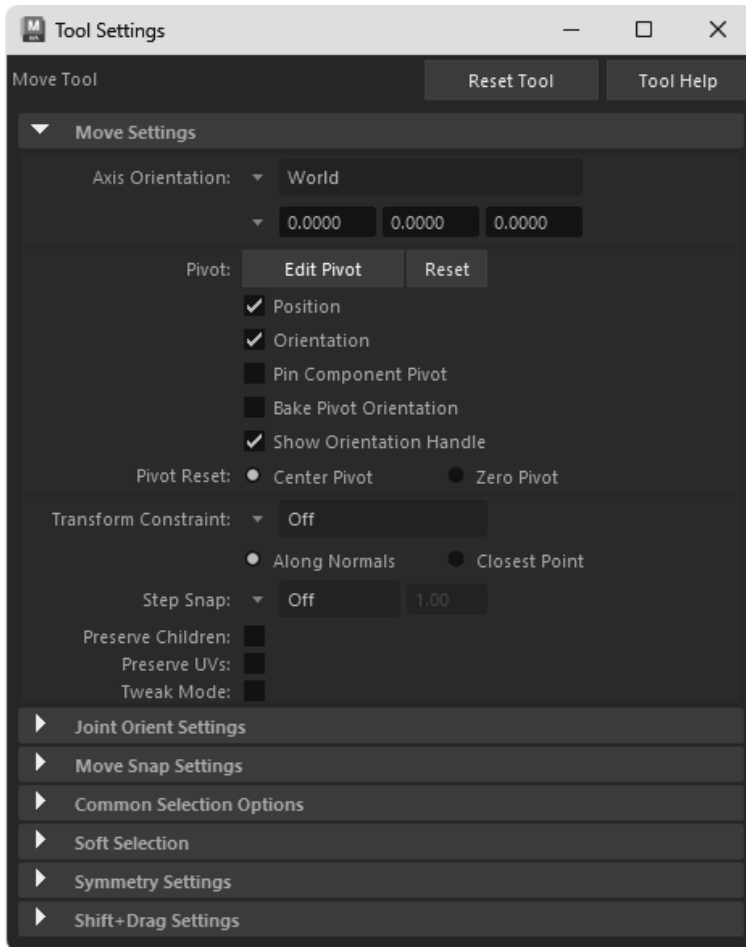
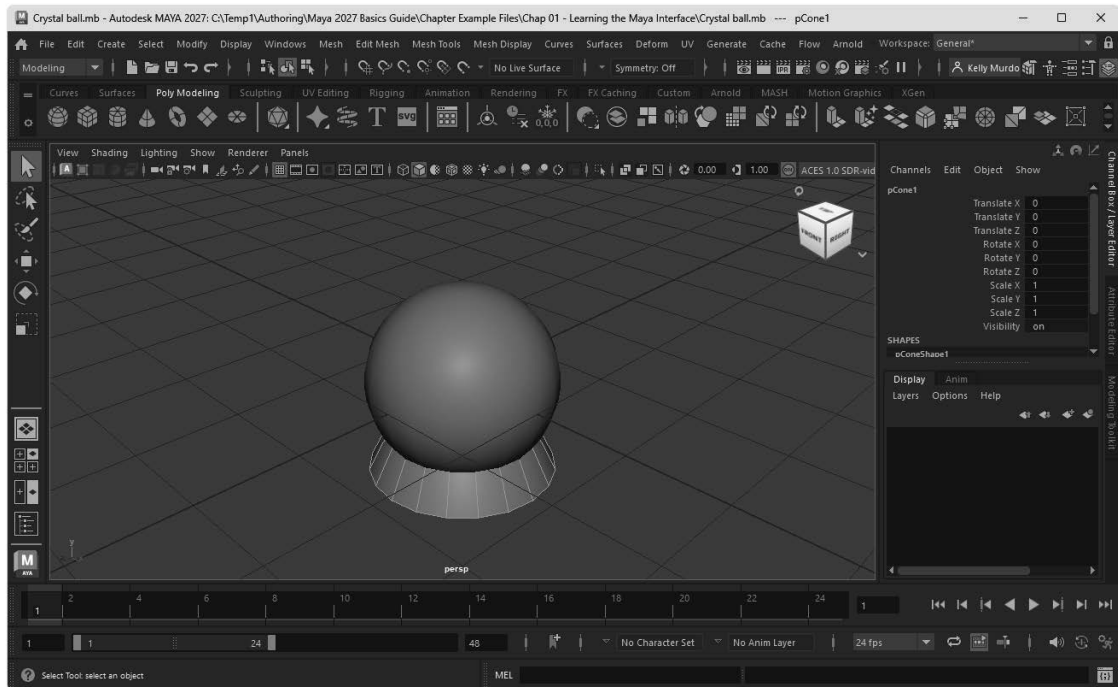

FIGURE 1-5

Tool Settings for the Move tool

### *Lesson 1.1-Tutorial 1: Use a Menu Command to Create a Polygon Sphere*

1. Click on the Create menu, and then select the Polygon Primitives submenu and click on the Options icon to the right of the Sphere menu to open the Polygon Sphere Options dialog box.
2. In the Polygon Sphere Options dialog box, click the Apply button.  
A single sphere object will appear at the origin in the view panel.
3. Click the Close button to exit the dialog box.
4. Click on the Create menu, and then select the Polygon Primitives submenu and click on the Cone menu command. A cone object is added to the scene overlapping the sphere.
5. Press the 5 key to see the objects as shaded objects, then press the F key to frame the objects. The objects resemble a simple crystal ball, as shown in Figure 1-6.
6. Select File, Save Scene As and save the file as **Crystal ball.mb**.

**FIGURE 1-6**

A simple crystal ball created with sphere and cone objects

## Lesson 1.2: Use the Status Line Buttons

Directly below the menus are a long row of buttons that are collectively known as the Status Line. These buttons are constant and cannot be changed, but you can hide them. The buttons are divided into groups that are separated by a dividing bar. Clicking on the dividing bar to the left of each group will hide and unhide the buttons. These button groups include, from left to right, the Menu Set list, File buttons, the Selection Mode menu, Selection Mode buttons, Selection Mask buttons, Snapping buttons, Enable Symmetry option, History buttons, Rendering buttons, the Transform fields, and the Show/Hide Editors buttons, as shown in Figure 1-7. Most of these button groups are presented and discussed in the lesson that corresponds to their features.

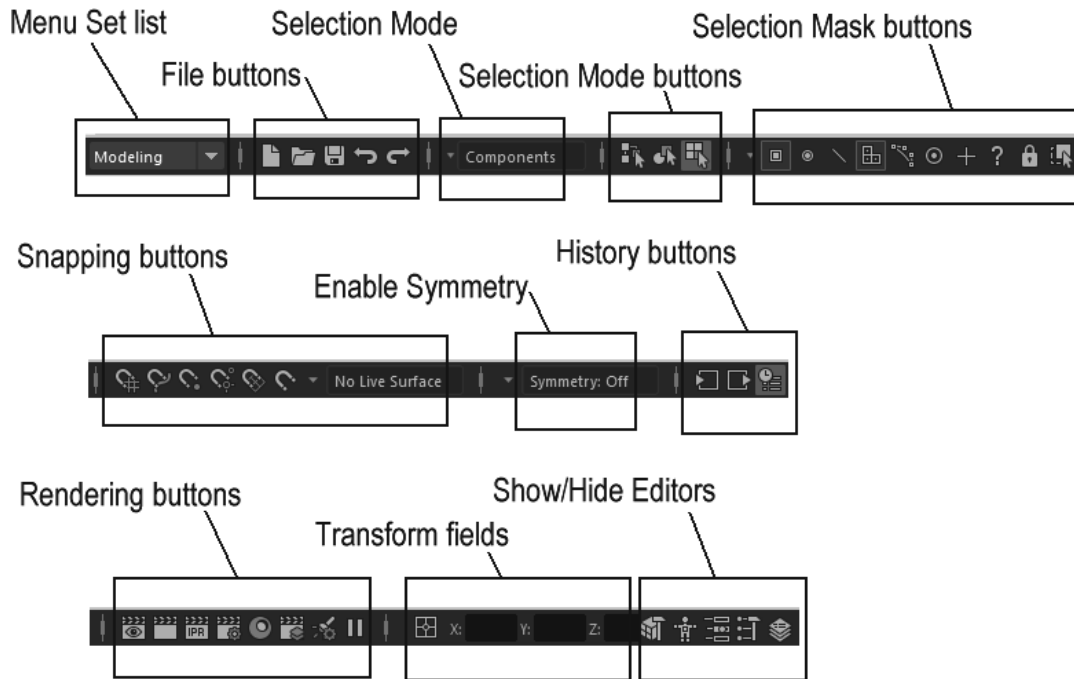

FIGURE 1-7

Status Line groups

## Using Pop-up Help

When you first begin to use the Status Line buttons, it can be tricky to know which button does what, but you can view the button's title as a **Pop-up Help** by holding the mouse cursor over the top of the button, as shown in Figure 1-8. Pop-up Help is available for all buttons in the entire interface.

### Note

If Pop-up Help starts to get annoying, you can disable it or set its Display Time using the Interface, Help panel in the Preferences dialog box opened with the Window, Settings/Preferences, Preferences menu command.

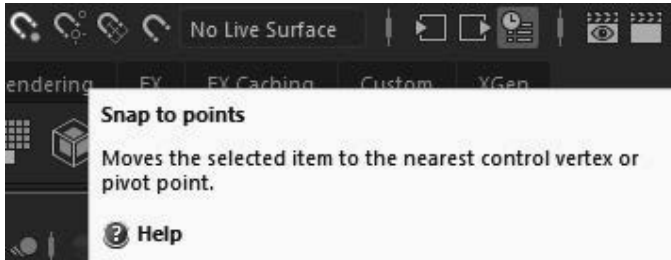

---

**FIGURE 1-8**

Pop-up Help

## Watching for Cursor Clues

Another helpful visual clue is that the cursor changes when it is over any interface button that has an available right-click pop-up menu. This new cursor displays a small menu icon under the cursor arrow, like the one shown in Figure 1-9. When this icon appears, you can right-click to access an additional menu of options. The cursor also changes when certain tools are used.



---

**FIGURE 1-9**

Cursor indicating a right-click pop-up menu

## Expanding and Collapsing Icon Button Groups

Each button group in the Status Line is divided by a vertical line with a small rectangle through its center. This divider is called the Show/Hide Bar, and if you click on it, all buttons included in that section will be hidden. Click again to make the buttons reappear. Figure 1-10 shows several collapsed and expanded button sets.





---

**FIGURE 1-10**

Expanded and collapsed button sets

## Opening and Saving a Scene

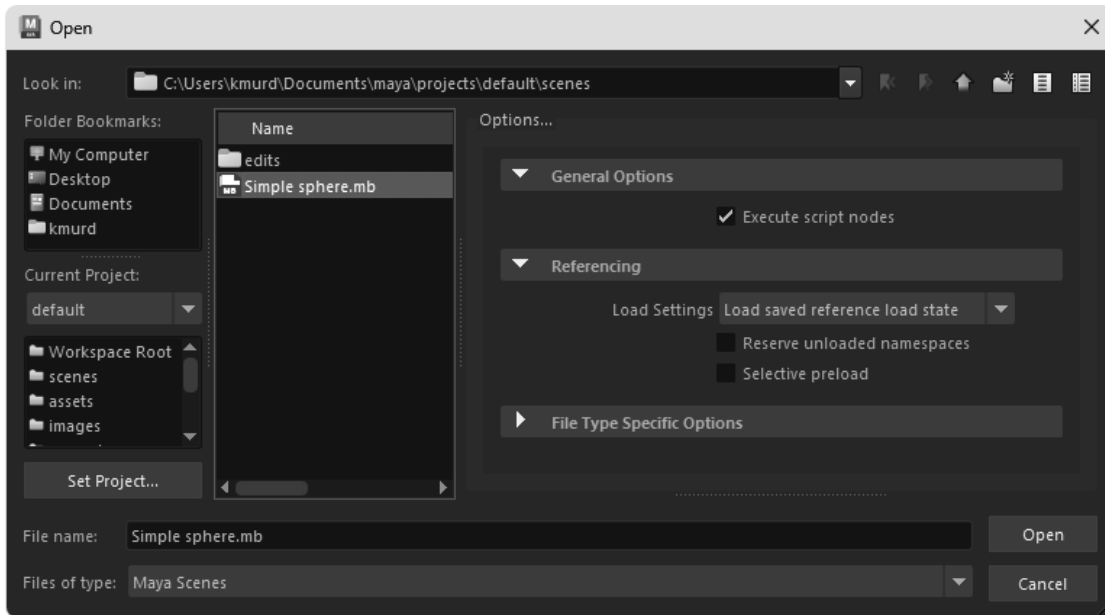
To the right of the Menu Set selection list is a set of buttons that you can use to create a new scene, open an existing scene, or save the current scene. Both the Open and Save buttons will open a file dialog box, as shown in Figure 1-11, in which you can select the directory and file name. When saved, the file name will appear on the title bar.

**FIGURE 1-11**

File dialog box for Windows

## Using the Home Screen

By default, the Maya Home Screen, shown in Figure 1-12, appears when Maya is first loaded. This Home Screen has a lot of useful information, but perhaps the most useful is the list of recently opened files and any crash recovery files. Recently opened files can be immediately opened by simply selecting them in the Home Screen.

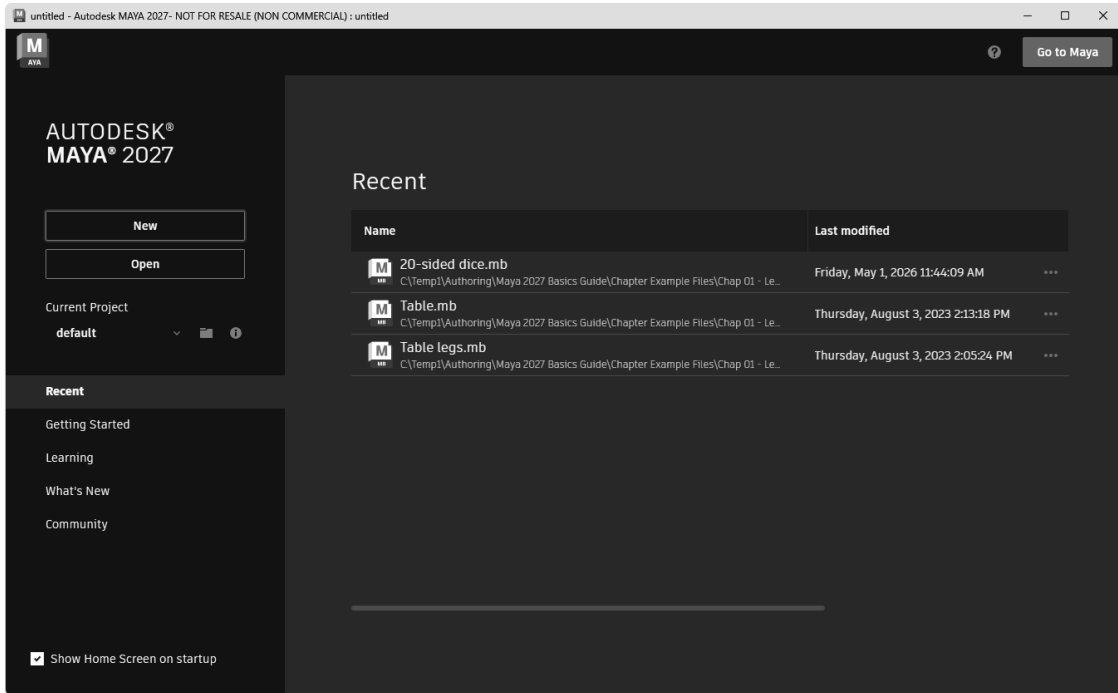

**FIGURE 1-12**

Maya Home Screen

You can move back and forth between the Maya interface and the Home Screen using the Home icon in the upper left corner of the interface on the menu bar and the Go to Maya button in the upper right corner of the Home Screen.

The Home Screen also includes options to open a new blank scene, open an existing file, set a current project, view tutorial videos or access the Community pages.

## Opening Editors

At the right side of the Status Line are several Sidebar buttons, shown in Figure 1-13, that don't belong to a button group and that are always visible. These Sidebar buttons are used to show and hide dialog boxes and sidebar panels that appear to the right of the view panel. The main ones to focus on right now are the Attribute Editor, Tool Settings, and Channel Box. There are also buttons for accessing the Modeling Toolkit and the Character Controls. The Attribute Editor lists all the attributes for the selected object, the Tool Settings will list all the configurable settings for the selected tool, and the Channel Box is a subset of attributes that can be animated, known as being *keyable*.

### Note

In the Interface, UI Elements panel of the Preferences dialog box, you can select to have each of the editors open as a separate window instead of within the main window.

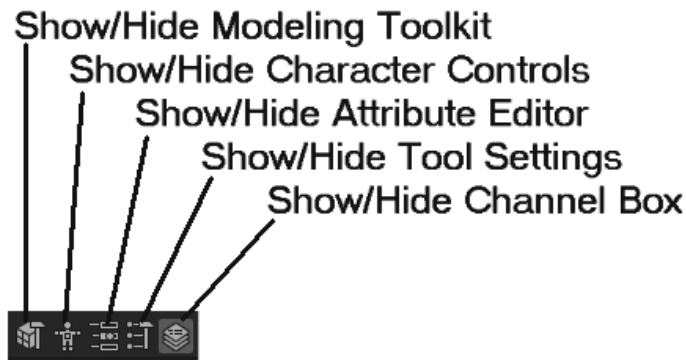

FIGURE 1-13

Sidebar buttons

## Showing and Hiding Interface Elements

You can also make any interface element into a floating toolbar by clicking on the dotted double line at the top (or to the left) of the interface element, as shown for the Status Line in Figure 1-14, and dragging it away from the interface. If you drag the element back on top of the interface, a blue line will appear where it will be dropped back into the interface. You can also close or hide a floating element by clicking on the X button in the upper right corner of the element. Use the Windows, UI Elements menu command to make any hidden interface elements visible again.

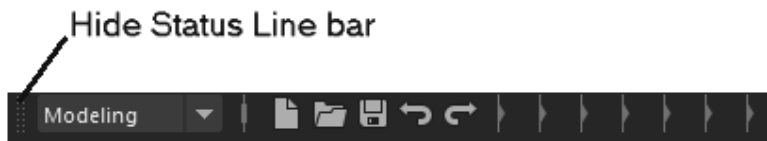

FIGURE 1-14

Hide interface element bar

### Lesson 1.2-Tutorial 1: Open a File

1. Move the mouse over the Status Line buttons at the left end until the Pop-up Help reads *Open a scene*.
2. Click on this button.
  - A file dialog box appears, similar to the one shown in Figure 1-11.
3. Locate the chapter 1 directory where the Skateboard.mb file is located.
4. Click on the Skateboard.mb file name and click the Open button.
  - The saved file is then loaded into Maya, as shown in Figure 1-15.

### Note

Before Maya opens a file, it gives you a chance to save the current file.

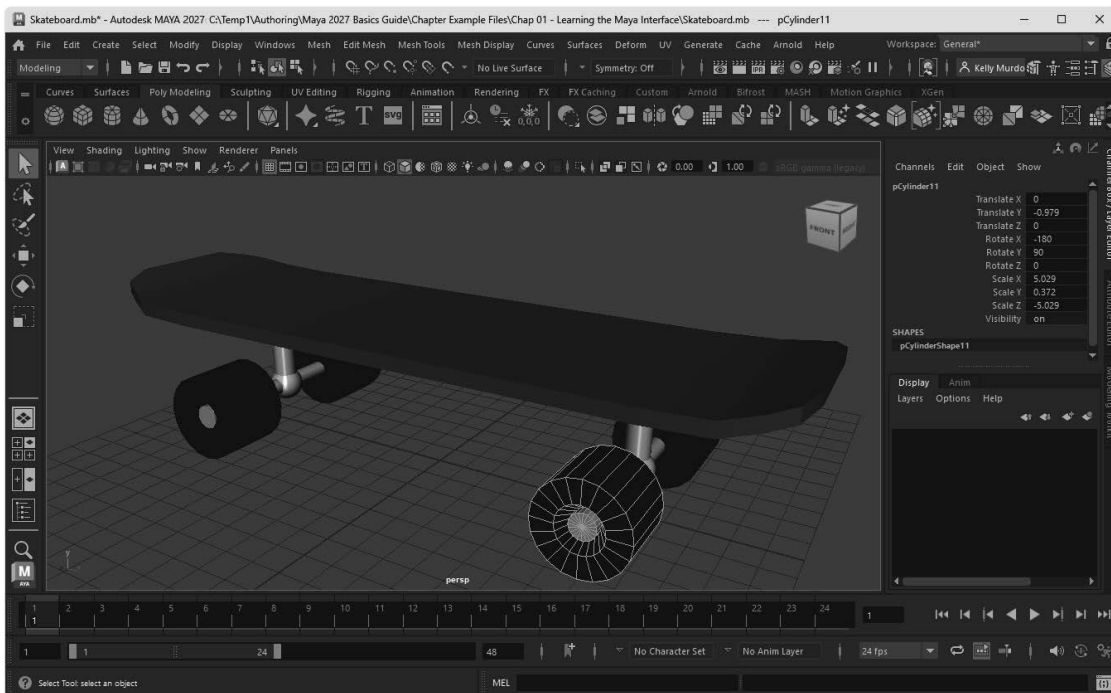

FIGURE 1-15

Opened skateboard file

### Lesson 1.2-Tutorial 2: Save a File

1. Click on the Create menu, and then select the Polygon Primitives submenu and click on the Sphere menu to add a sphere to the skateboard scene.
2. Move the mouse over the Status Line buttons at the left end until the Pop-up Help reads *Save the current scene*.
3. Click on this button.

This file is automatically saved replacing the existing file. When saved, the file name appears in the title bar.

#### Note

You can save the scenes with a new file name using the File, Save As menu command.

### Lesson 1.2-Tutorial 3: Maximize the Workspace Interface

1. Click and drag on the dotted double line on the left end of the Status Line and move it away from the interface.  
The Status Line becomes a floating control.
2. Click and drag the dashed double lines for the Shelf, and the Toolbox to make each of these interface elements floating controls.

3. Click and drag on the dashed double lines for the controls at the bottom of the interface to make them floating also. Then close all the floating controls.

All interface elements will now be floating, maximizing the Workspace, as shown in Figure 1-16.

**Tip**

A quicker way to maximize the Workspace is with the `Windows, UI Elements, Hide All UI Elements` menu command.

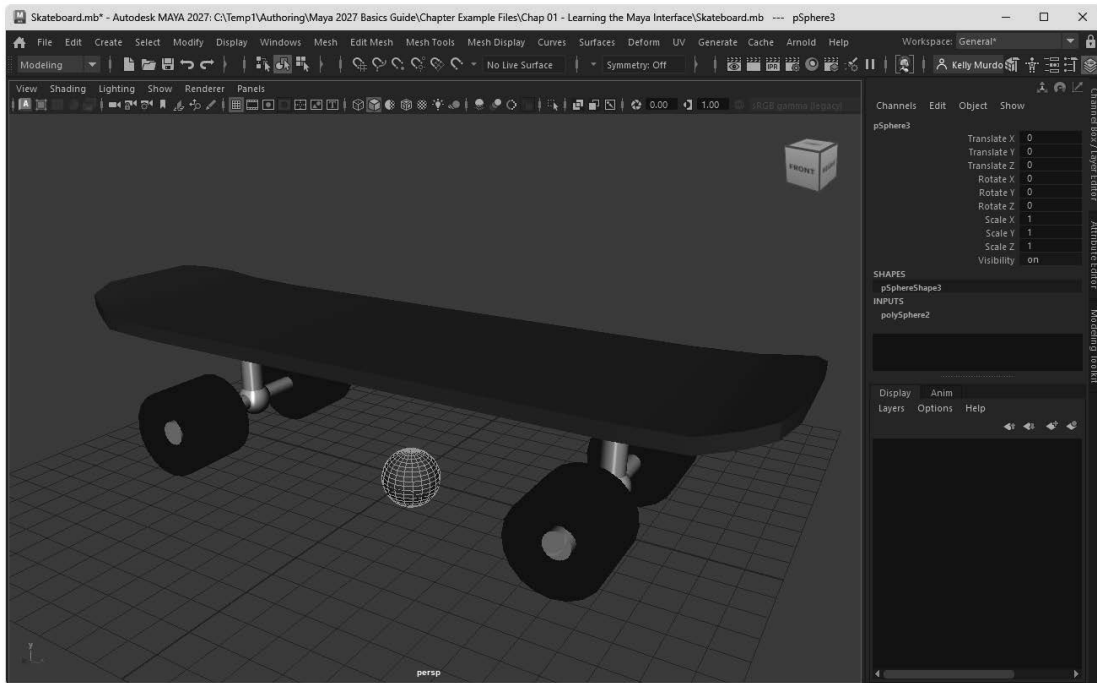

**FIGURE 1-16**

A maximized Workspace interface

4. Select the `Windows, Workspaces, Reset Workspace to Factory Default` menu command.

All the standard interface elements reappear.

## Lesson 1.3: Access the Shelf

The Shelf is like a toolbar on steroids. It includes several tabbed panels of buttons. To select a different set of buttons, just click on one of the tabs and the buttons in its set will appear. Figure 1-17 shows the buttons for the Poly Modeling tab.

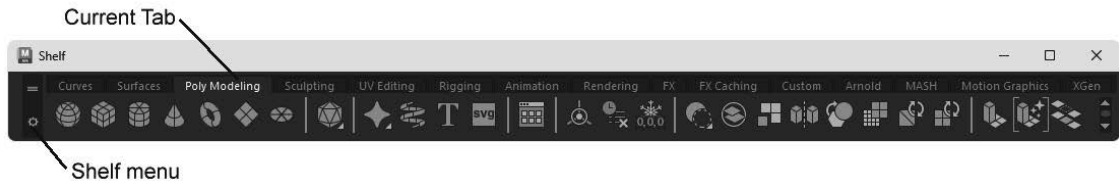

---

**FIGURE 1-17**

The Shelf

## Using the Shelf Menu

At the left end of the Shelf are two menu icons. The top one looks like a mini-tab and you can use it to select a Shelf tab from a menu. The bottom menu icon is a round star. You can use it to hide all of the Shelf tabs, open the Shelf Editor, create and delete shelves, load a custom shelf, and save all shelves. You can save some interface space by hiding the Shelf tabs. To do this, select Shelf Tabs menu command from the Shelf menu to toggle the option off.

## Creating and Deleting Shelves

The Shelf menu can also be used to create and delete shelves. The New Shelf menu command will open a simple dialog box, as shown in Figure 1-18, in which you can name the new shelf. The new empty shelf will then appear at the right end of the tabs. Selecting the Delete Shelf menu command will delete the currently selected shelf.

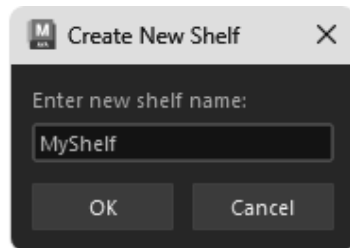

---

**FIGURE 1-18**

Create New Shelf dialog box

## Adding Icons and Menu Commands to a Shelf

You can add buttons from any shelf to another shelf by selecting the button and dragging it with the middle mouse button onto the tab of the shelf that you wish to add it to. Menu commands can also be added to the current shelf by clicking on the menu command with the Ctrl/Command and Shift keys held down. You can delete a shelf by selecting it and choosing the Delete Shelf menu from the Shelf menu.

### Note

Maya uses all three mouse buttons. If you are using a two-button mouse with a scroll wheel, the scroll wheel acts as the middle mouse button. If your two-button mouse doesn't have a scroll wheel,

you can use the Ctrl/Command (command) key and the left mouse button as the middle mouse button. For a Macintosh one-button mouse, the command key and the mouse button act as the middle mouse button and the Option key and the mouse button act as the right mouse button.

## Adding Layouts and Scripts to a Shelf

You can add custom layouts to a shelf. Just pick the shelf you want to hold the custom layout and then choose Panel Editor from the Panels menu, located at the top of the view panel. In the Layouts tab, shown in Figure 1-19, select the custom layout that you want to add to the current shelf and click the Add To Shelf button. You can drag scripts from the Script Editor with the middle mouse button and drop them into a shelf. Scripts appear on the Shelf as a button labeled 'MEL', which stands for Maya Embedded Language, Maya's scripting language. More on scripting is covered in Chapter 16, "Using MEL Scripting."

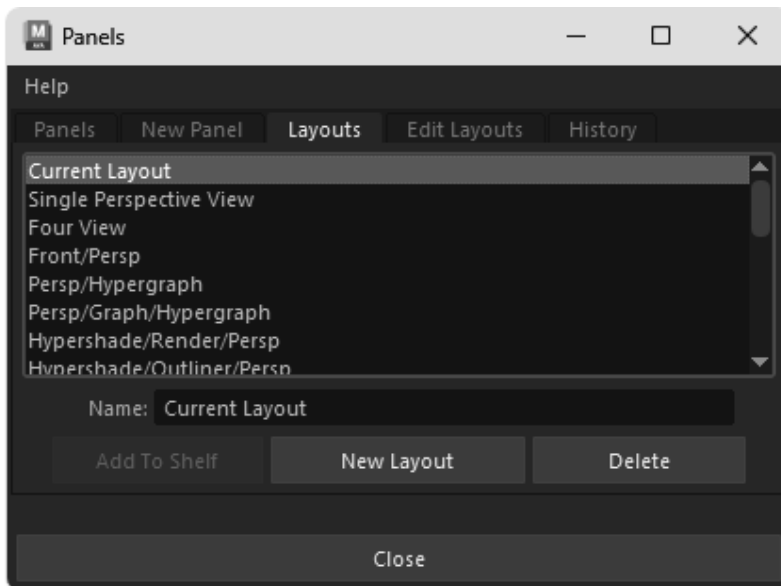

FIGURE 1-19

Panel Editor

## Using the Shelf Editor

The Shelves menu includes an option that will open the Shelf Editor dialog box. Using this editor, shown in Figure 1-20, you can reorder and rename the tabs and shelves, edit the icons within each shelf, and change the settings for the shelves.

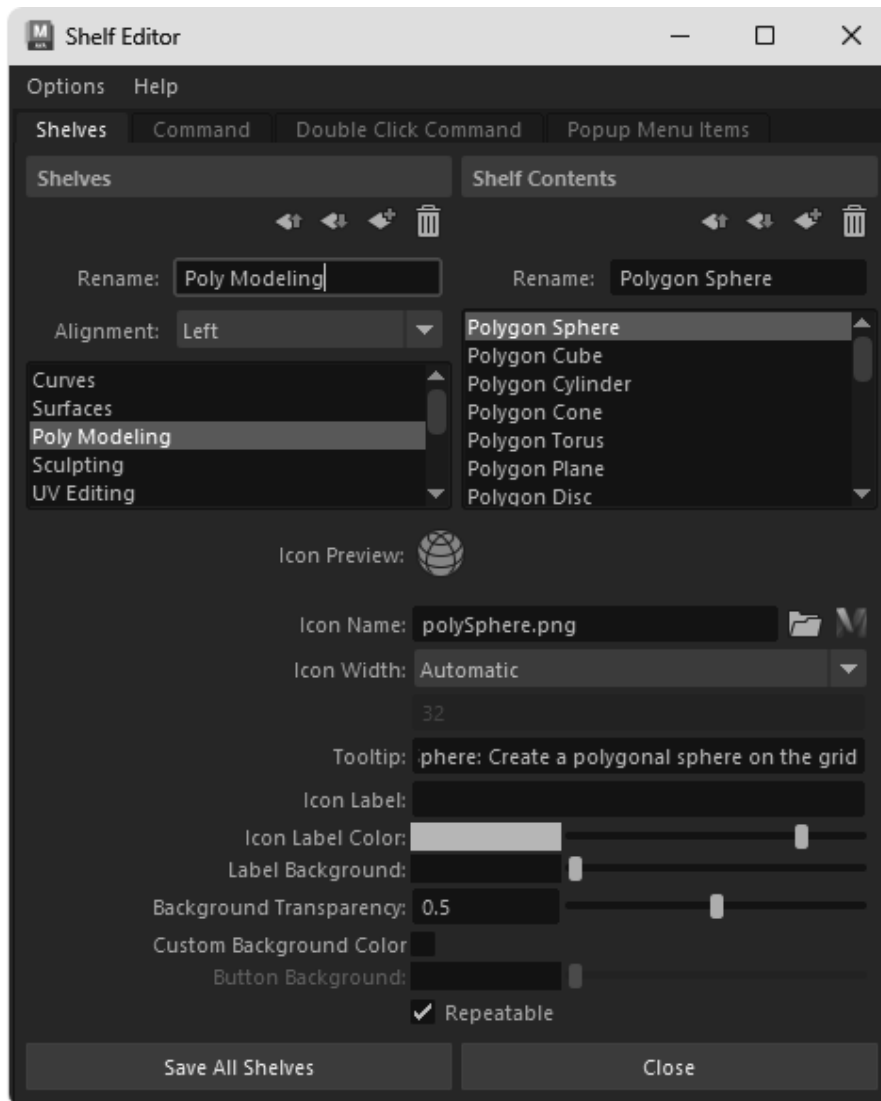

FIGURE 1-20

Shelf Editor

### Lesson 1.3-Tutorial 1: Create a New Shelf

1. Click on the Shelf menu and select New Shelf.  
The Create New Shelf dialog box appears.
2. Type the name **MyShelf** for the new shelf and click OK.  
A new tab with the typed name appears at the right end of the Shelf.

### Lesson 1.3-Tutorial 2: Populate a New Shelf

1. Select the MyShelf tab to make it active.

2. Hold down the Shift and Ctrl/Command keys and select Create, NURBS Primitives, Sphere.  
A sphere icon is added to the new shelf.
3. Repeat Step 2 with other primitive objects found in the Create menu.  
Each of the selected menu commands appears on the new shelf, as shown in Figure 1-20.
4. Select the Panels, Panel Editor panel menu command.  
The Panel Editor dialog box appears.
5. Select the Layout tab and choose the Four View option. Then, click the Add to Shelf button and then the Close button.  
When the Four View option is selected, the view window changes to show four separate views. After clicking the Add to Shelf button, a new icon appears in the current shelf.
6. Locate the Move tool in the Toolbox and drag the icon with the middle mouse button to the new shelf.  
Dragging an icon with the middle mouse button adds the icon to the current shelf. Figure 1-21 shows the new shelf.
7. Select Save All Shelves from the Shelf menu.

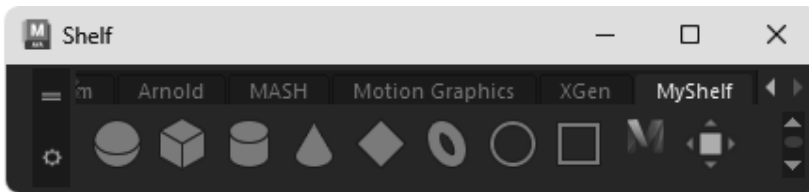

FIGURE 1-21

A custom shelf of menu commands

## Lesson 1.4: Explore the Channel Box and Layer Editor

When an object is selected, its keyable attributes (or channels) appear within the Channel Box, shown in Figure 1-22, to the right of the interface. Each attribute has a value associated with it. These values are often numbers, but they can be a state like on or off, or a color. You can change these values by selecting the channel's value, entering a different value, and pressing the Enter key.

### Tip

Drag on the left edge of the Channel Box to increase or decrease the Channel Box width. You can make the Channel Box a floating panel by dragging its tab away from the interface.

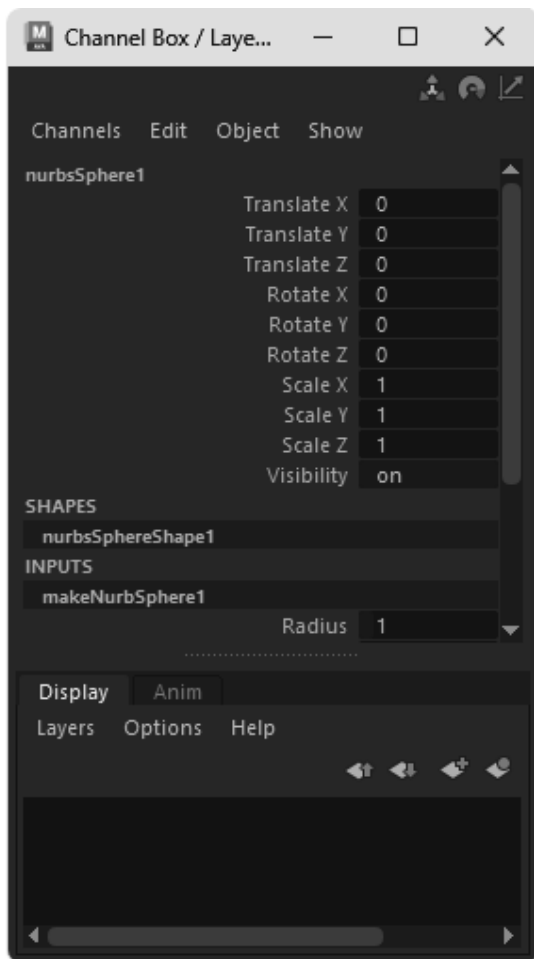
**FIGURE 1-22**

The Channel Box

## Selecting Attributes

You can select a single attribute by clicking on its title. When selected, the attribute title will be highlighted. Holding down the Ctrl/Command key while clicking on several attributes will allow you to select multiple attributes at once; you can also drag the mouse over several attributes to select them.

## Changing Attributes with the Mouse

You can interactively change attribute values by selecting an attribute in the Channel Box and then dragging with the middle mouse button in the view panel.

## Locking Attributes

Locked attributes cannot be changed. You can lock an attribute by selecting it and choosing the Lock Selected menu command from the Channels menu. Locked attributes will have a gray rectangle to the left of the channel

value, as shown in Figure 1-23. Unlock any locked attributes using the Channels, Unlock Selected menu command.

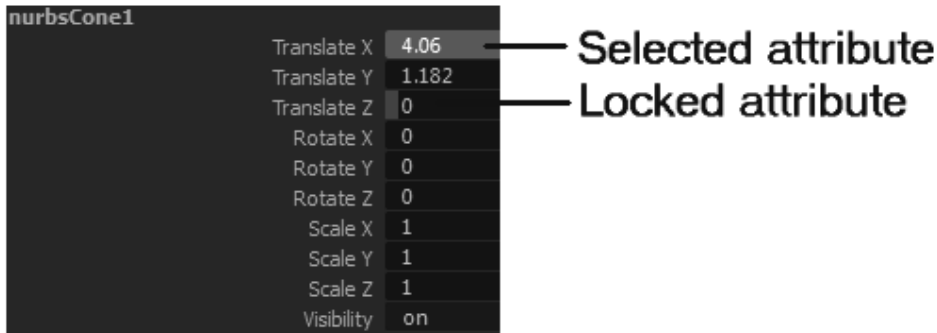

**FIGURE 1-23**

Locked attributes in the Channel Box

---

## Adding and Deleting Layers

The Layer Editor, shown in Figure 1-24, divides the scene elements up into layers, making them easy to show and hide. For example, you could place all the background objects on one layer and the main characters on another layer; then to work on the main characters, simply enable that layer and you don't have to worry about the background objects getting in the way. Clicking the Create a New Layer button in the Layer Editor creates a new layer. You can give each layer a name, display type, playback option and color. Delete layers using the Layers menu. Deleting a layer does not delete its objects. At the top of the Layer Editor are tabs for working with both Display and Animation layers.

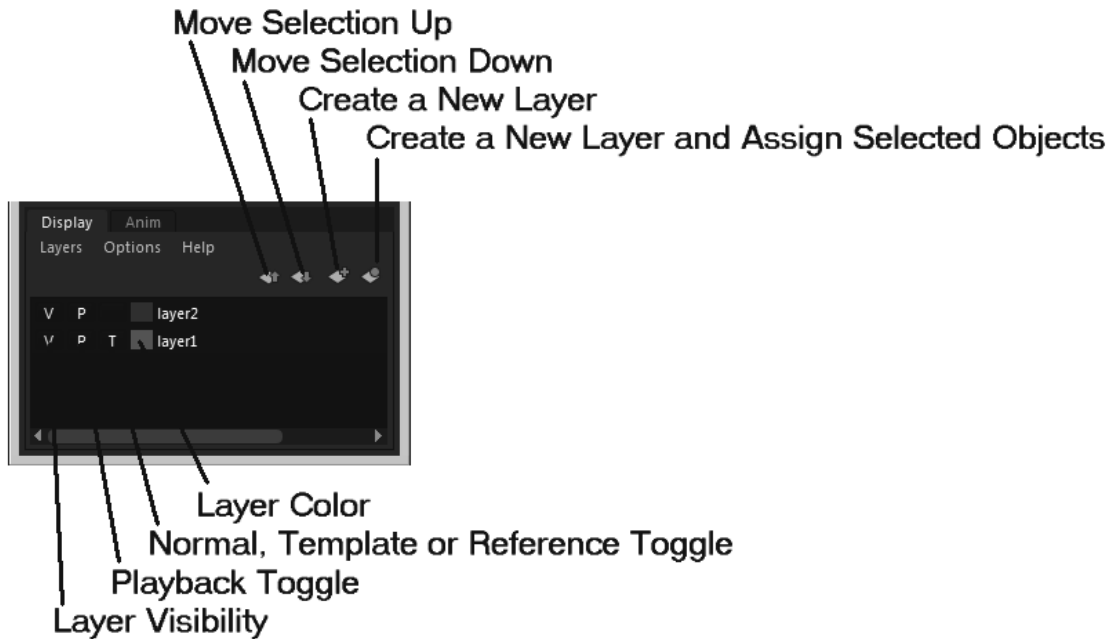

FIGURE 1-24

Layer Editor

## Adding Objects to a Layer

You can add selected objects to a layer by right clicking on that layer and selecting Add Selected Objects from the pop-up menu. You can also use the Layers menu to select all objects in a layer and to remove objects from a layer. Objects assume the layer color when viewed as wireframe and unselected.

## Hiding All Layer Objects

You can hide Layer objects by clicking the first column in the Layer Editor. This column sets the visibility for the layer objects and is a simple toggle button that you can turn on or off. The letter *V* appears when the layer objects are visible, and the column is empty when the layer objects are hidden. The second column toggles the playback of the layer objects on or off. The letter 'P' appears when playback is enabled.

## Freezing All Layer Objects

The third column can be set to Normal, Template or Reference. The letter *T* appears in this column when the layer is a template. Template layers cannot be selected or moved while they are templates. References are proxy objects that stand in for complex objects. The fourth column is the layer color. Double-clicking on this column (or on the layer name) opens the Edit Layer dialog box, shown in Figure 1-25, where you can select a new color, change the layer's attributes, or change the layer's name.

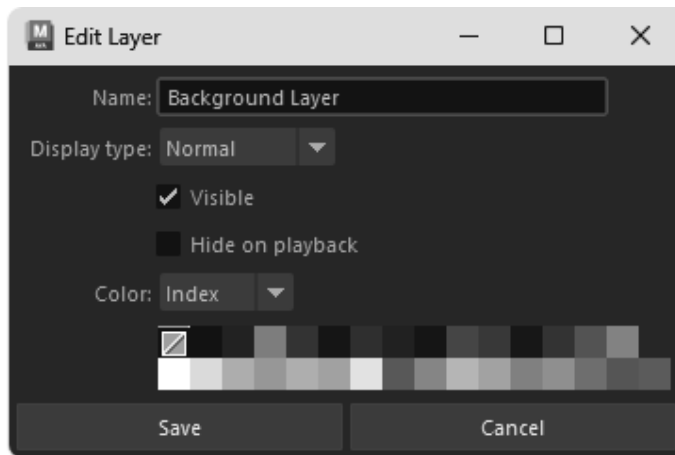

FIGURE 1-25

Edit Layer dialog box

---

### *Lesson 1.4-Tutorial 1: Change Channel Box Attributes*

1. Select File, Open Scene. Locate and open the Translated Rocket.mb file.  
This file includes a simple rocket centered about the grid origin. All attributes for the rocket object are displayed in the Channel Box.
2. Select the Select, All menu command.  
This selects all the objects that make up the rocket.
3. Enter a 5 in the Translate X attribute and press the Enter key.  
The rocket object is moved five units along the X-axis.
4. Click on the Translate Y attribute in the Channel Box and drag upward in the Workspace with the middle mouse button.  
The rocket object is moved along the Y-axis a distance equal to the amount that the mouse was dragged and the attribute value is changed, as shown in Figure 1-26.
5. Select File, Save Scene As and save the file as **Translated rocket.mb**.

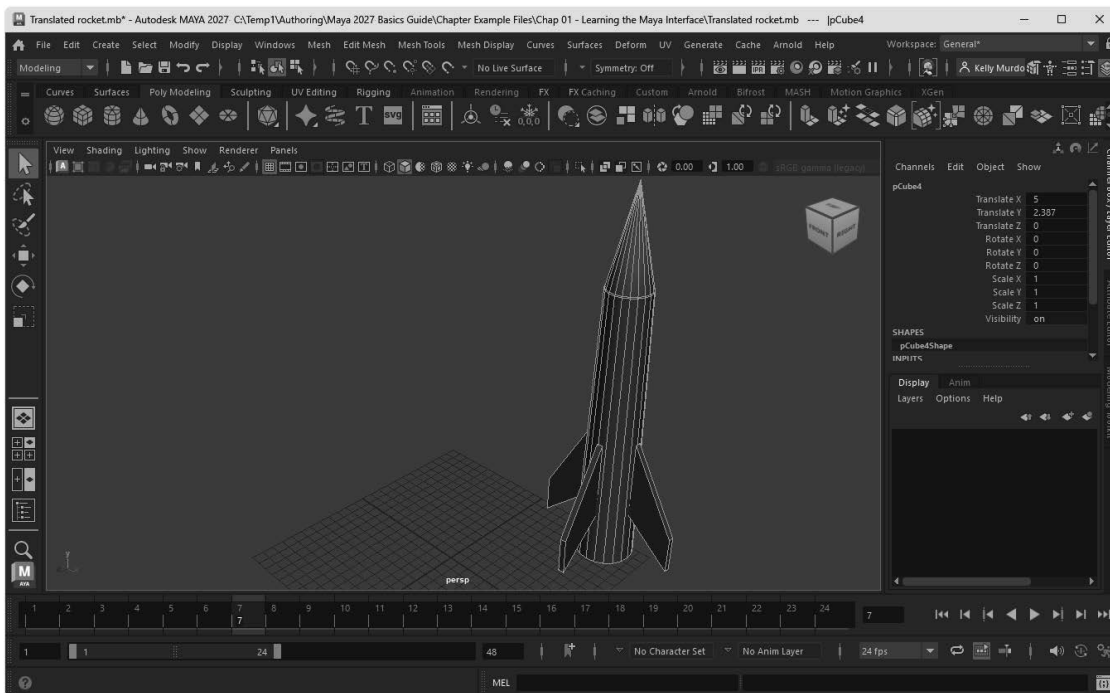

FIGURE 1-26

Translated rocket

### Lesson 1.4-Tutorial 2: Create and Rename a New Layer

1. Click the Create a new layer button in the Layer Editor.  
A new layer appears in the Layer Editor.
2. Double-click on the layer to open the Edit Layer dialog box.
3. Type in a name for the new layer and click the Save button.

### Lesson 1.4-Tutorial 3: Add Objects to a New Layer

1. Select Create, Polygon Primitives, Sphere to create a sphere object.
2. In the Layer Editor, right click on the new layer and select Add Selected Objects from the pop-up menu.  
The sphere object is added to the new layer.
3. In the Layer Editor, click on the first column in which the V is displayed.  
All objects on the layer are hidden.

## Lesson 1.5: Identify the Animation Controls, the Command Line, and the Help Line

At the bottom of the interface are several interface controls that are used to move through the various animation frames. Below these is a Command Line where you can type in commands to be executed. At the very bottom of the interface is a Help Line where context-specific information is displayed.

## Selecting an Animation Frame

All current animation frames are displayed on the Time Slider at the bottom of the interface, as shown in Figure 1-27. You move between the different frames by dragging the gray time marker or by entering the frame number in the field to the right of the Time Slider.

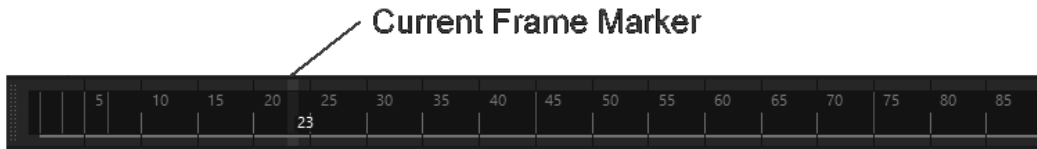
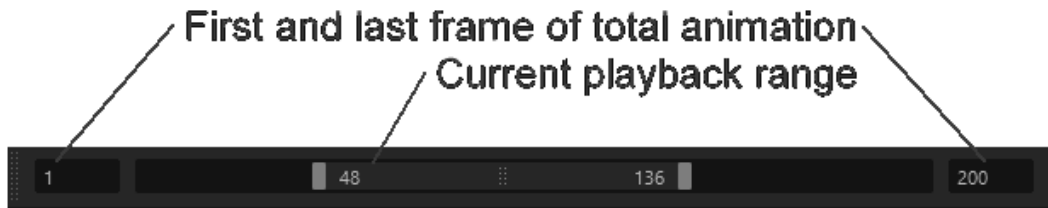

**FIGURE 1-27**

Time Slider

## Setting an Animation Range

Below the Time Slider is the Range Slider, as shown in Figure 1-28. Using this slider, you can focus on a specific range of animation frames. The total number of frames selected in the Range Slider are shown in the Time Slider. The Time Slider changes as the Range Slider is moved. You can extend the total number of animation frames by increasing the Last Frame of Total Animation value to the right of the Range Slider.

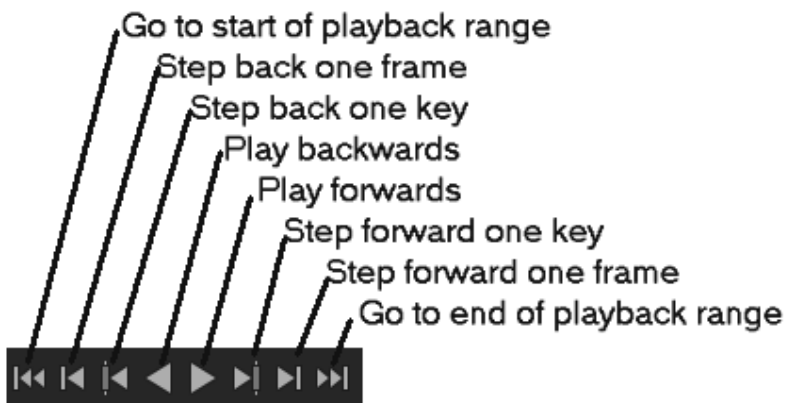

**FIGURE 1-28**

Range Slider

## Playing an Animation

To the right of the animation frame value are several controls for playing, rewinding, and moving through the animation frames, as shown in Figure 1-29. Using these buttons, you can jump to the animation start (or end), step back (or forward) one frame, step back (or forward) one key, or play the animation forward (or backward).



---

**FIGURE 1-29**

Animation controls

## Accessing the Animation Preferences

Beneath the Go to End button is a button, shown in Figure 1-30, that will open the Preferences dialog box, as shown in Figure 1-31. This dialog box includes all of the preferences for Maya, but when it is opened using this button the Time Slider category is selected, allowing you to change the animation preferences.



---

**FIGURE 1-30**

Animation Preferences button

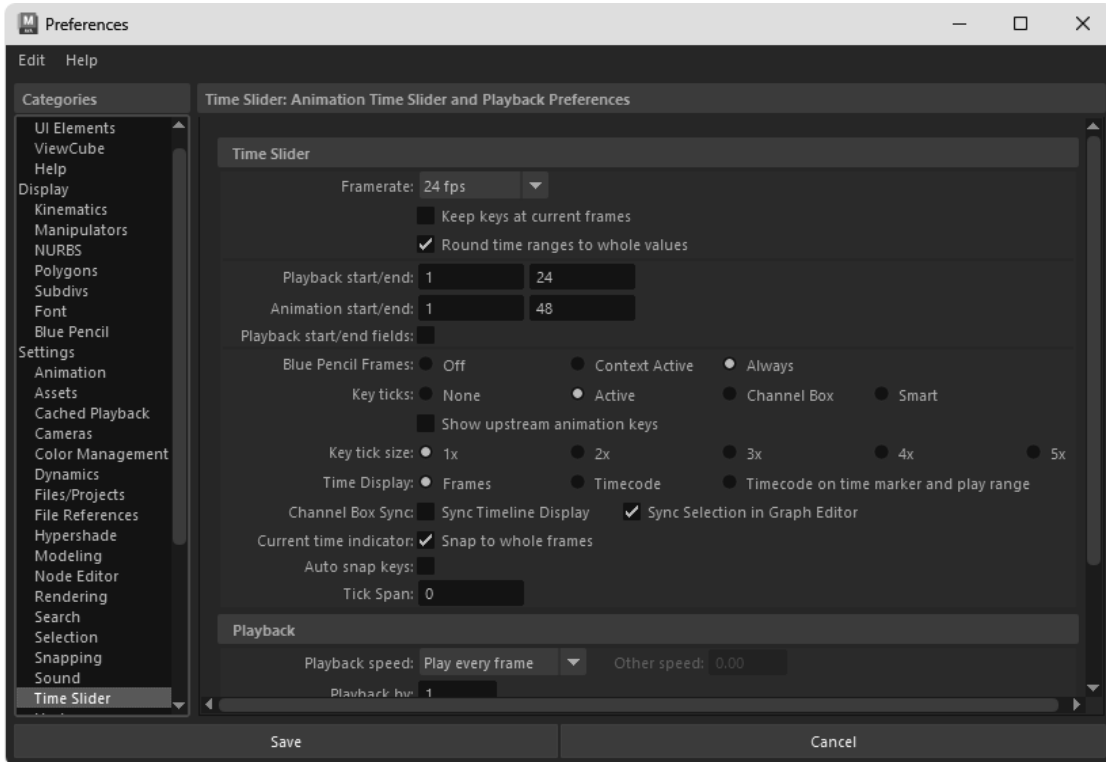

FIGURE 1-31

Preferences dialog box

## Using the Command Line

In the Command Line, you can enter textual commands to be executed. All commands should end with a semicolon. The results of these commands are displayed in the dark-colored Results line to the right of the Command Line. To the right of the Results line is the Script Editor button, shown in Figure 1-32, that opens the Script Editor, where you can enter more detailed scripts. More on the Script Editor is covered in Chapter 16, “Using MEL Scripting.”

### Tip

All commands that are entered into the Command Line are saved in a buffer. Using the Up and Down Arrow keys, you can scroll back and forth through the existing commands. Pressing the Enter key executes the listed command.

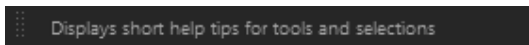

FIGURE 1-32

Script Editor button

## Viewing the Help Line

At the very bottom of the interface is the Help Line, as shown in Figure 1-33. Within this line, Maya lists instructions that it expects to happen next based on the selected tool or mode. If you're stuck on what to do next, take a look at the Help Line.

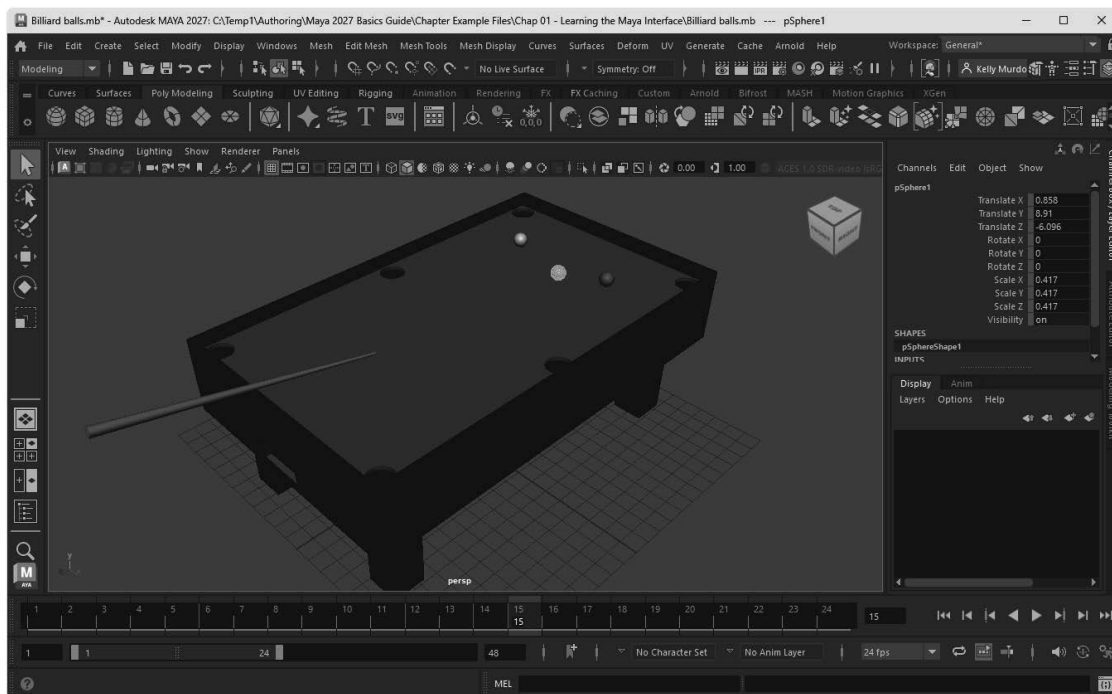

**FIGURE 1-33**

Help Line

### Lesson 1.5-Tutorial 1: Play an Animation

1. Select File, Open Scene and open the Billiard balls.mb file.  
This file includes a simple animated scene.
2. Click on the time marker in the Time Slider and drag it to the left.  
The objects in the scene will move as the frames are increased. A frame of the animation sequence is shown in Figure 1-34.



**FIGURE 1-34**

Animated billiard table

3. Click the Play Forwards button.  
The entire animation sequence will play over and over.
4. Click the Stop button to pause the animation.

### Lesson 1.5-Tutorial 2: Enter a Command

1. Select Create, Polygon Primitives, Sphere to create a sphere object.
2. Click on the view panel away from the sphere to deselect it.
3. In the Command Line, type **select pSphere1;** and press the Enter key.  
The sphere object is selected.
4. In the Command Line, type, **move -z 10;**  
The sphere is moved ten units along the z-axis.
5. Select File, Save Scene As and save the file as **Command line sphere.mb.**

## Lesson 1.6: Use the Toolbox

On the left side of the interface is a column of buttons collectively known as the Toolbox, as shown in Figure 1-35.

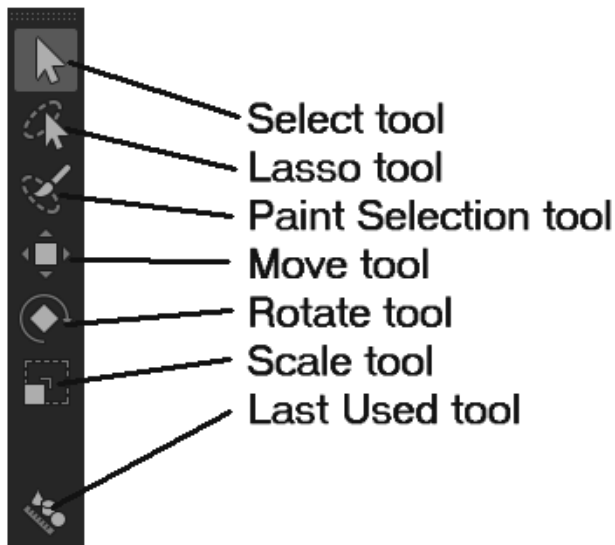

FIGURE 1-35

Toolbox

## Selecting Objects

The first three buttons in the Toolbox are used to select objects in the scene. These are the Select Objects tool, the Lasso tool and the Paint Selection tool. The Select Object tool lets you select objects by clicking on objects or by dragging a rectangular border. The Lasso tool lets you drag a freehand outline over the object you want to select. The Paint Selection tool lets you drag or paint over components (such as vertices) to select them.

Holding down the Shift key while clicking on objects with the Select Objects tool will add objects to the selection set. All selected objects will appear white except for the last object selected, which will appear light green. This light green object is known as the *key object*. More details on selecting objects are covered in Chapter 4, "Working with Objects."

## Using the Transform Tools

The Toolbox also includes the Move, Rotate, and Scale tools. When any of these tools are selected, a manipulator will appear at the center (pivot point) of the selected object. With these tools, you can transform the selected object. The manipulator lets you transform the tool along a single axis or within a single plane, as shown for the Move tool in Figure 1-36. You can also click on the transform values displayed on the Status Line or in the Channel Box and enter new values using the keyboard.

### Tip

Once a transform handle on one of the transform tools is selected, it turns yellow. You can then drag the selected handle using the middle mouse button.

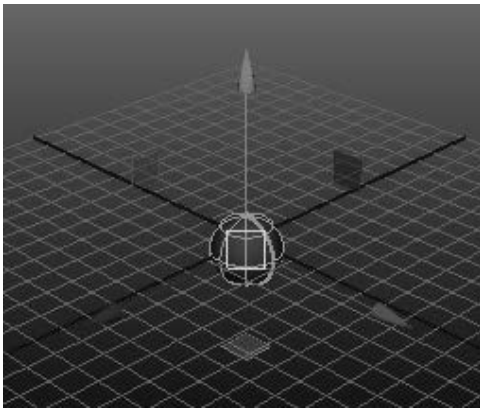

FIGURE 1-36

Manipulator controls for the Move tool

## Understanding Manipulators

Each of the transform manipulators has color-coded components that will let you constrain a transform to a single axis—red is for the X-axis, green is for the Y-axis, and blue is for the Z-axis, as shown in Figure 1-37. The selected manipulator axis will turn yellow and dragging will transform the object along the selected axis.

### Tip

The Hotkeys for the transform tools are q for Select Object, w for Move, e for Rotate, and r for Scale.

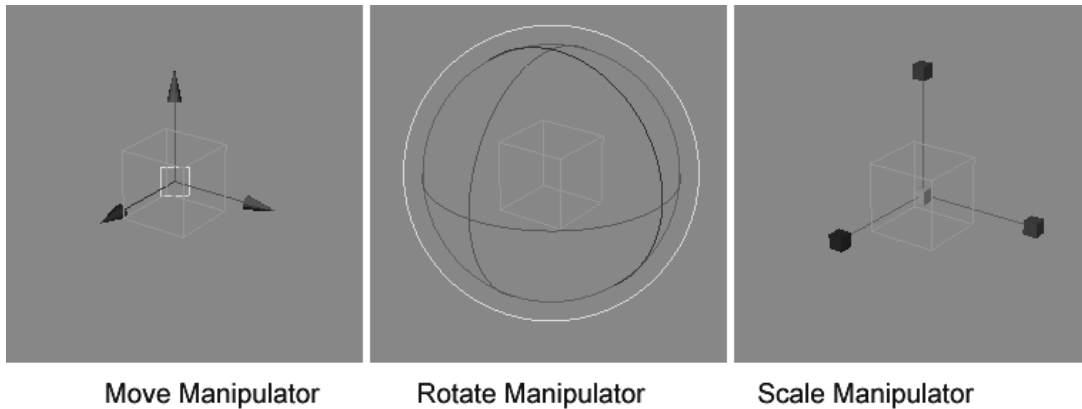

---

**FIGURE 1-37**

Transform Manipulators

There are many other manipulators besides the transform manipulators. For example, when a spotlight object is selected, you can enable a manipulator that lets you alter its light properties such as its falloff cone, direction and intensity by dragging in the view.

Beneath the Scale tool button in the Toolbox is another button that holds the last tool that was used. Remember that any menu item or button that includes the word *Tool* in its name will remain active until another tool is selected and will appear at the bottom of the Toolbox.

**Note**

The last slot in the Toolbox is reserved for tools selected from the menus. The Toolbox tools will not occupy this slot.

**Lesson 1.6-Tutorial 1: Select Objects**

1. Open the Table parts.mb file.  
This file includes five box objects that are used to make a table.
2. Click on the Select tool and click on one of the cube objects.  
The selected cube in the scene turns light green and its attributes appear in the Channel Box.
3. Hold down the Shift key and click on the other cubes in the scene.  
All cubes in the scene are selected and the last cube clicked on will be light green.
4. With all 4 cubes selected, enter a value of 6 in the Scale Y attribute in the Channel Box.  
All cubes in the scene are scaled along their Y-axis to create the legs of a table, as shown in Figure 1-38.

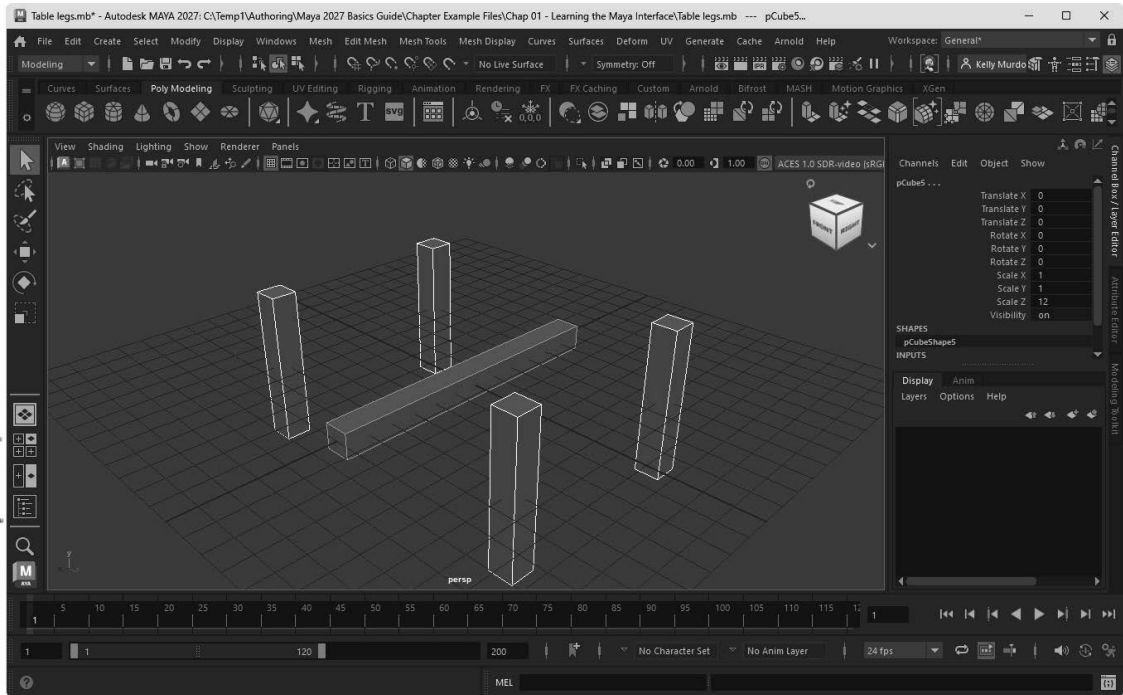

FIGURE 1-38

Selected objects

### Lesson 1.6-Tutorial 2: Transform an Object

1. Open the Table.legs.mb file again.
2. Click on the Select tool and click on the stretched box object in the center of the scene.
3. Click the Move tool in the Toolbox and drag the green (Y-axis) upward until it is above the four leg objects.  
The box object moves upward in the scene.
4. Click the Scale tool in the Toolbox and drag the red (X-axis) to the right until it covers the four leg objects to create a table.  
The box object is elongated along the X-axis, as shown in Figure 1-39.
5. Select File, Save Scene As and save the file as **Table.mb**.

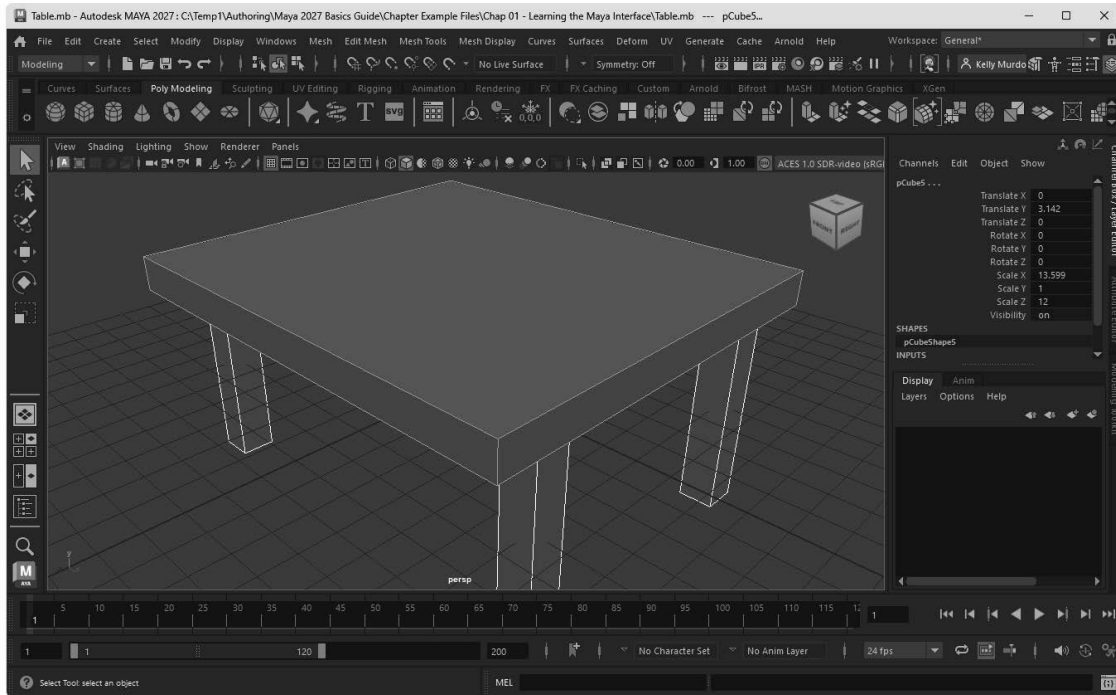

FIGURE 1-39  
Transformed objects

## Lesson 1.7: Discover the Marking Menu

Once you get used to the menu commands, you can learn to work faster using the hidden marking menus. These menus will pop-up different commands when you right-click on objects in the scene.

### Accessing the Marking Menus

For quick access to many common commands, you can open a **marking menu** by right-clicking in the view panel and holding the mouse button down until the menu appears. You can then move the cursor between the different menu options and release the mouse button to select the desired menu command. Figure 1-40 shows the marking menu for a polygon sphere object.

#### Tip

You can access a marking menu of selection options by holding down the `q` key while clicking in the view panel. You can access other custom marking menus in a similar manner such as Move Tool options (`w`), Rotate Tool options (`e`), Scale Tool options (`r`), and Polygon Brush options (`o`).

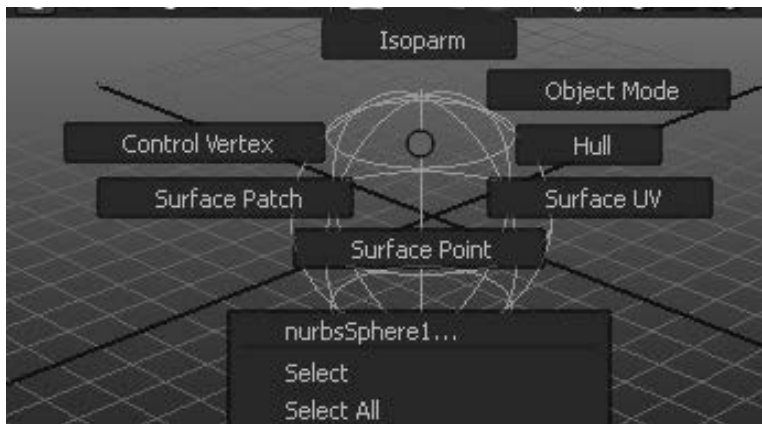

**FIGURE 1-40**

Marking menu

## Customizing Marking Menus

You can alter the contents of a marking menu, assign a hotkey to a marking menu, or add a marking menu to the **Hotbox** using the Marking Menu Settings dialog box, shown in Figure 1-41. You access this dialog box using the Windows, Settings/Preferences, Marking Menu Editor menu command.

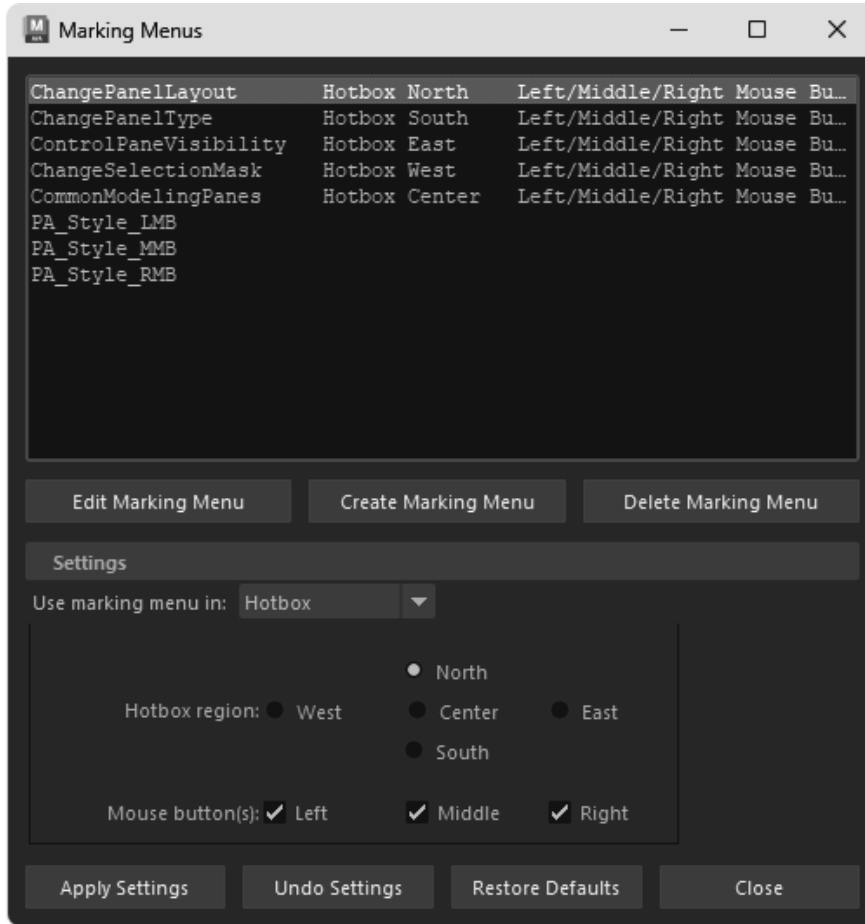

FIGURE 1-41

Marking Menus Settings dialog box

## Using the Hotbox

The Hotbox, shown in Figure 1-42, is a complete set of customizable menus that you can access by pressing and holding the Spacebar. Using the Hotbox Controls option in the Hotbox, you can select which menu commands appear in the Hotbox.

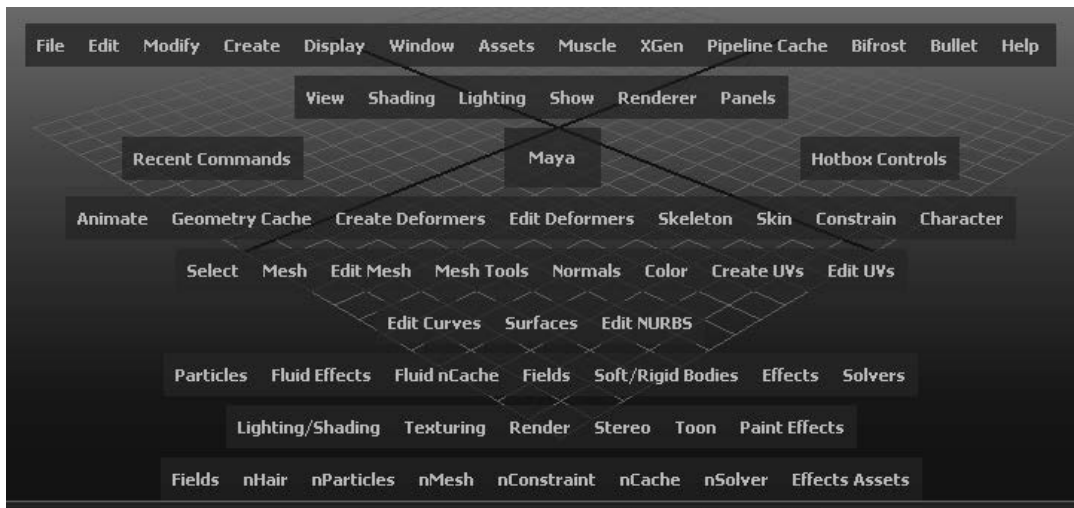

FIGURE 1-42

Hotbox

## Customizing the Hotbox

If you select the Hotbox Controls option from the Hotbox, you can select which menu sets to include in the Hotbox. You can also select to Show or Hide all menus.

### *Lesson 1.7-Tutorial 1: Access a Marking Menu*

1. Select Create, Polygon Primitives, Sphere to create a sphere object.
2. Click on the view panel away from the sphere to deselect it.
3. Right-click on the sphere and choose Select from the pop-up marking menu.  
The sphere object is selected.

### *Lesson 1.7-Tutorial 2: Use the Hotbox*

1. Move the cursor to the center of the view panel and press and hold the Spacebar.  
The Hotbox appears centered around where the cursor is located, as shown in Figure 1-43.
2. Drag the cursor to the Create button and select the Polygon Primitives, Sphere command.  
The sphere object appears in the view panel.
3. Release the Spacebar.

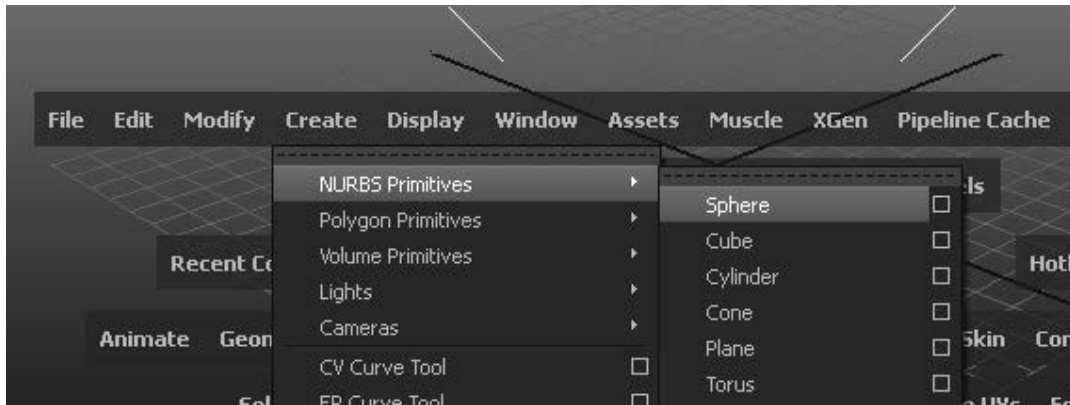

FIGURE 1-43

The Hotbox

## Lesson 1.8: Get Help

Maya is a complex piece of software with tons of features, and it is easy to get lost when looking for a specific command. To help navigate all these features, there are several resources to try out including the Help menu, The Search box and Autodesk Assistant.

### Accessing the Help menu

At the very right end of the menu is a Help menu. Included in this menu are commands to access the Maya Help documents with the F1 key. These help files open within a web browser, as shown in Figure 1-44. There are also options to take a Quick Tour, view Interactive Tutorials and link to the YouTube Learning Channel. The Scripting Reference command includes help files for MEL and Python. You can also give feedback on Maya to Autodesk directly.

#### Tip

At the bottom of the Toolbox and Layout buttons is a Maya logo button. This button opens the Maya Help files in a web browser.

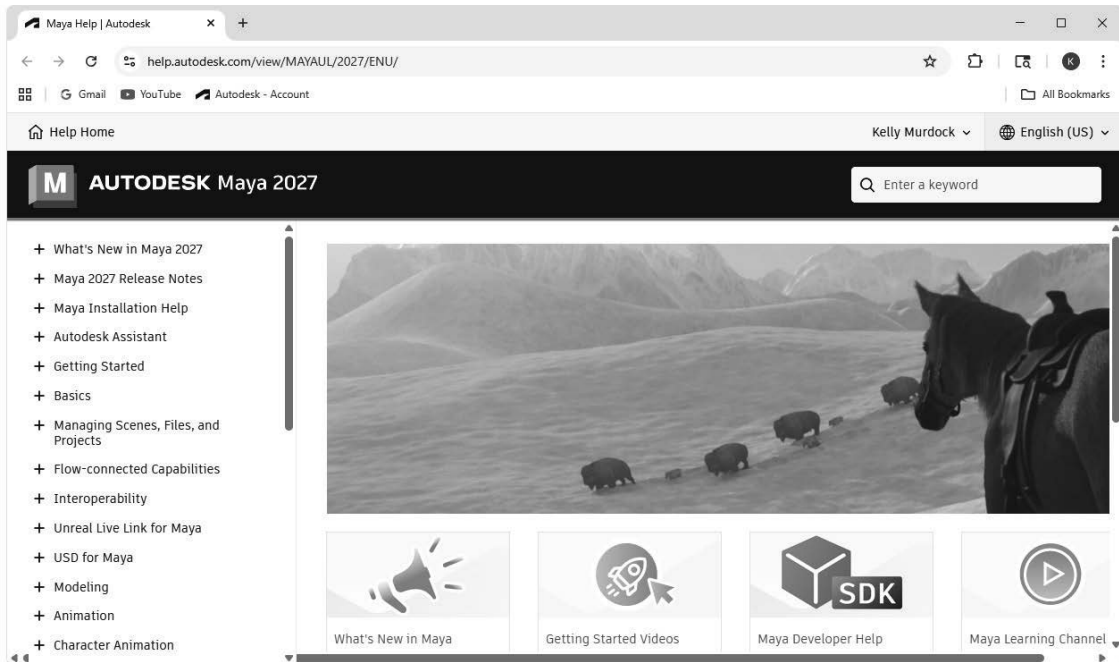

FIGURE 1-44

The Maya help files

## Searching Commands, Tools and Scene Objects

Underneath the layout buttons is a Search button with a magnifying glass icon. You can open this Search text field by clicking on this icon, selecting Search from the Help menu, or by pressing the Command/Ctrl + F key. If you open the pop-up menu under the Search icon, you can choose from Search (for tools and commands), Select (for selecting scene objects), MEL (for searching or running MEL commands), and Python (for searching or running Python commands). At the right end of the Search field is a Filter icon that can be used to filter the search list to specific topics such as Animation, Modeling, Curves, etc.

If you type into the Search field, Maya will present a list of all the commands or tools that match the entered text. For example, if you enter 'extrude' in the Search field, Maya presents a list of commands to extrude curves, to extrude components and the Wedge command, as shown in Figure 1-45. If you select the extrude components command from the Search list, the Edit Mesh, Extrude command is automatically selected just as if you selected it from the menu and you can use it right away. Also, notice that the Search feature does context searching and will find something similar to what you requested without matching the exact text such as the Wedge command in the above example.

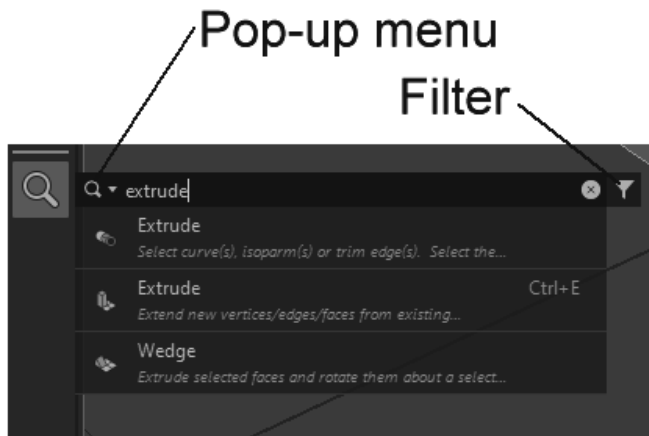

**FIGURE 1-45**

Search tools and commands

If you select the Select option from the pop-up menu, then any scene objects that match the typed text are immediately selected. This provides another quick way to select objects without having to open the Outliner.

The MEL and Python search options let you search for specific scripting commands and if you select a command from the search list, the command is automatically executed.

## Using Autodesk Assistant

At the bottom of Help menu is a command to access the Autodesk Assistant. This feature opens a dialog box, shown in Figure 1-46, where you can use an AI assistant to get specific step-by-step commands on performing a specific task. For example, if I ask the assistant how to “lathe a curve over 180 degrees,” it gives me the specific steps to do this. It also gives me steps to edit the sweep angle after creation, the Maya and Python scripts to do the same, and links to the help pages for more information.

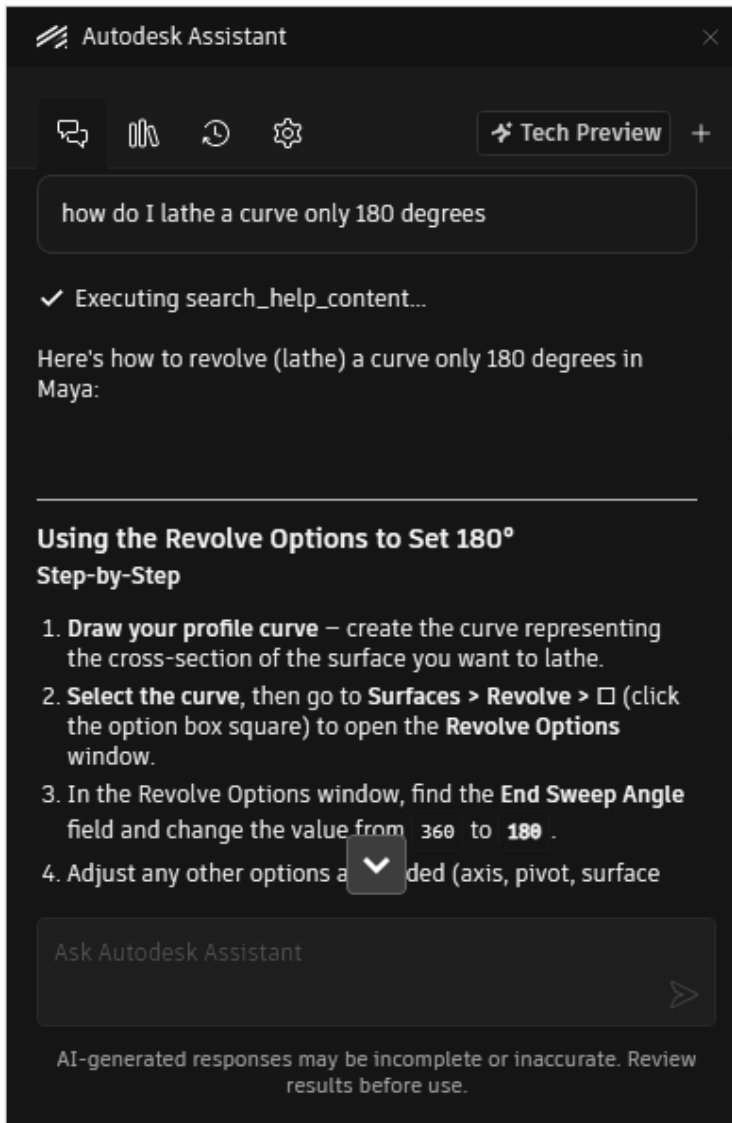

**FIGURE 1-46**

Autodesk Assistant gives step-by-step commands for specific tasks.

### *Lesson 1.8-Tutorial 1: Search for a Command*

1. Select the File, Open Scene menu command and select the Billiard balls.mb file to open.  
A perspective view of the billiard table object is displayed.
2. Underneath the Quick Layout buttons, click on the Search button. In the Search field that appears, type Blue Pencil.  
A list of commands appears.
3. Select the first option in the list and press Enter.  
The Blue Pencil mode is selected then its toolbar appears.

4. Mark up the scene with the Blue Pencil tools, as shown in Figure 1-47.
5. Select File, Save Scene As and name the new scene **Billiard balls with notes**.

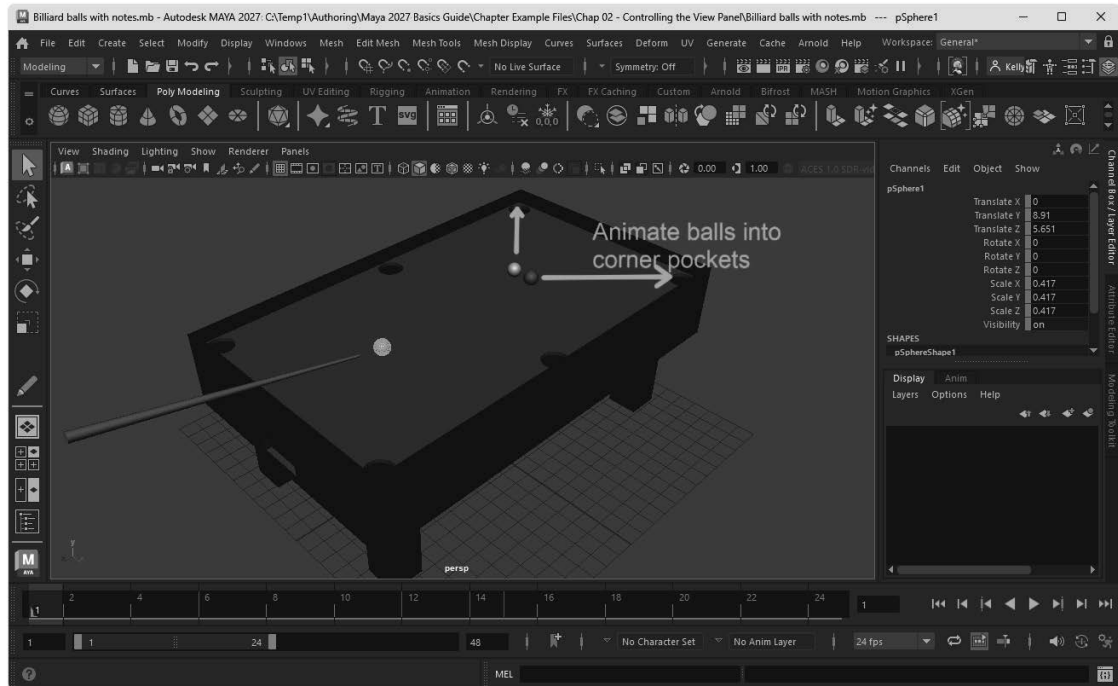

FIGURE 1-47

Billiard balls scene with notes

### Lesson 1.8-Tutorial 2: Use Autodesk Assistant

1. Select the Help, Autodesk Assistant menu command.  
The Autodesk Assistant dialog box opens.
2. In the Ask Autodesk Assistant text box type in the question, “**How do I create a 20-sided dice?**”  
A list of commands appears.
3. Locate and copy the MEL Script text, then paste this script into the MEL field at the bottom of the Maya interface and press the Enter key.  
A 20-sided object appears in the View panel.
4. Press the F key to frame the selected object.  
The object’s size fills the View panel, as shown in Figure 1-48.
5. Select File, Save Scene As and name the new scene **20-sided dice**.

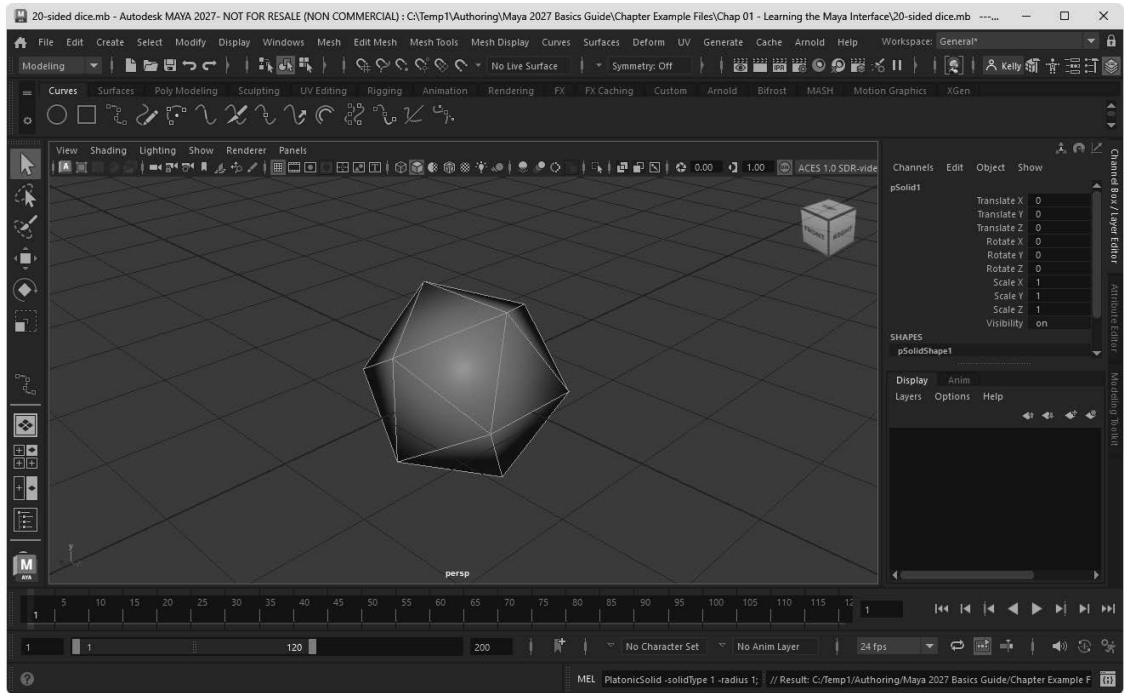

FIGURE 1-48

20-sided dice created with Autodesk Assistant

## Chapter Summary

This chapter takes you through a tour of the Maya interface, covering the basic interface elements, including the menus, the Status Line buttons, the Shelf, the Channel Box, the Layer Editor, the Animation Controls, the Command Line, the Help Line, and the Toolbox buttons. This chapter also explains how to work with these various interface elements and presents the marking menus and the Hotbox as other ways to work with the interface. The chapter concludes with some ideas on resources for getting help.

## What You Have Learned

In this chapter, you learned

- \* How to switch between the different menu sets.
- \* How to use keyboard hotkeys.
- \* How to access option dialog boxes from menus.
- \* How to tear off menus.
- \* The difference between tools and actions.
- \* How to use pop-up help to identify buttons.
- \* How to identify a change in the cursor denoting right-click menus.

- \* How to expand and contract button sets.
- \* How to open and save scene files.
- \* How to show and hide the different interface elements.
- \* How to use the Shelf.
- \* How to add and delete items from a Shelf.
- \* How to use parameters in the Channel Box.
- \* How to use the Layer Editor.
- \* How to work with the animation controls.
- \* How to use the Command and Help Lines.
- \* How to select and transform objects using the Toolbox tools.
- \* How to use and customize the marking menus and the Hotbox.
- \* How to search for commands, tools and scene objects.
- \* How to use the AI-powered Autodesk Assistant.

## Key Terms From This Chapter

- \* **Menu set.** A dynamic set of menu options selected from a drop-down list at the top left of the interface.
- \* **Hotkey.** A keyboard shortcut that executes a command when pressed.
- \* **Option dialog box.** A dialog box with additional options opened using the icon found to the right of specific menu options.
- \* **Tear-off menu.** A panel of menu options that is removed to float freely from the interface.
- \* **Status Line.** A set of toolbar icons located at the top of the interface.
- \* **Pop-up help.** A small text title that appears when the cursor is held over the top of an icon.
- \* **Shelf.** A customizable set of buttons organized into separate groups.
- \* **Channel Box.** A panel of editable parameters that relate to the current selection.
- \* **Layer.** A selection of objects grouped together into a set that can be easily selected.
- \* **Animation controls.** A set of buttons used to control animation frames.

- \* **Command Line.** A text field where you can enter text commands.
- \* **Help Line.** A text field that presents the next action that is expected.
- \* **Toolbox.** A set of selection and transformation icons located to the left of the interface.
- \* **Marking menu.** A dynamic set of menus accessible by right-clicking on an object.
- \* **Hotbox.** A comprehensive set of menu options accessible by pressing the Spacebar.
- \* **Autodesk Assistant.** An AI-powered help resource that lets you use normal language statements to get step-by-step instructions for completing a task.

