

Autodesk®

3ds Max® 2027 Basics Guide

TEXT AND VIDEO INSTRUCTION

Videos
Includes Video Tutorials



Kelly L. Murdock



Better Textbooks. Lower Prices.
www.SDCpublications.com



ACCESS CODE
UNIQUE CODE INSIDE

Visit the following websites to learn more about this book:



[amazon.com](https://www.amazon.com)

[Google books](https://books.google.com)

[BARNES & NOBLE](https://www.barnesandnoble.com)

Chapter 2

Controlling and Configuring the Viewports

IN THIS CHAPTER

Understanding 3D space

Using the ViewCube and the SteeringWheels

Navigating with the mouse and the Viewport Navigation Control buttons

Changing the visual style of the viewports

Changing viewport layouts and adding information to the viewports

Displaying materials, lighting, and shadows

Loading a viewport background image

Controlling the display settings with the Viewport Settings dialog box

Although the Autodesk® 3ds Max®2027 software consists of many different interface elements, such as panels, dialog boxes, and menus, the viewports are the main areas that will catch your attention. The four main viewports make up the bulk of the interface. You can think of the viewports as looking at the television screen instead of the remote. Learning to control and use the viewports can make a huge difference in your comfort level with 3ds Max. Nothing is more frustrating than not being able to rotate, pan, and zoom the view.

The viewports have numerous settings and controls that you can use to provide thousands of different ways to look at your scene, and beginners can feel frustrated at not being able to control what they see. 3ds Max includes several handy little gizmos that make navigating the viewports much easier. This chapter includes all the details you need to make the viewports reveal their secrets.

If the Viewport Navigation Controls help define what you see, the Viewport Configuration dialog box helps define how you see objects in the viewports. You can configure each viewport using this dialog box.

Understanding 3D Space

It seems silly to be talking about 3D space because we live and move in 3D space. If we stop and think about it, 3D space is natural to us. For example, consider trying to locate your kids at the swimming pool. If you're standing poolside, the kids could be to your left or right, in front of you or behind you, or in the water below you or on the high dive above you. Each of these sets of directions represents a dimension in 3D space.

Now imagine that you're drawing a map that pinpoints a kid's location at the swimming pool. Using the drawing (which is 2D), you can describe the kid's position on the map as left, right, top, or bottom, but the descriptions of above and below have been lost. By moving from a 3D reference to a 2D one, the number of dimensions has decreased.

The conundrum that 3D computer artists face is this: How do you represent 3D objects on a 2D device such as a computer screen? The answer that 3ds Max provides is to present several views, called *viewports*, of the

scene. A viewport is a small window that displays the scene from one perspective. These viewports are the windows into the software's 3D world. Each viewport has numerous settings and viewing options.

Learning Axonometric versus Perspective

When it comes to views in the 3D world, two different types exist: axonometric and perspective. Axonometric views are common in the CAD world, where the viewer is set at an infinite distance from the object such that all parallel lines remain parallel. A perspective view simulates how our eyes actually work and converges all points to a single location off in the distance.

You can see the difference between these two types of views clearly if you look at a long line of objects. For example, if you were to look down a long row of trees lining a road, the trees would eventually merge on the horizon. In axonometric views, lines stay parallel as they recede into the distance. Figure 2.1 shows this example with the axonometric view on the left and the perspective view on the right.

FIGURE 2.1

Axonometric and perspective views

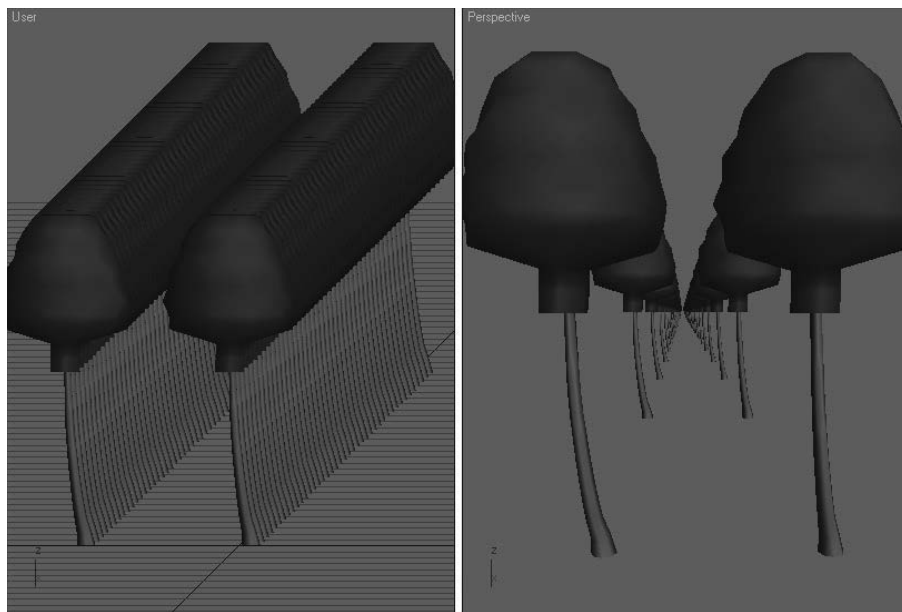

Learning orthographic and isometric views

If you dig a little deeper into axonometric views, you find two different types: orthographic and isometric. Orthographic views are displayed from the perspective of looking straight down an axis at an object. This reveals a view in only one plane. Because orthographic viewports are constrained to one plane, they show the actual height and width of the object, which is why the CAD world uses orthographic views extensively. Isometric views are not constrained to a single axis and can view the scene from any location, but all dimensions are still maintained. The words *isometric* and *orthographic* are often interchanged, but they refer to a view that has consistent dimensions.

Discovering the viewports in 3ds Max

Available orthographic viewports in 3ds Max include Front, Back, Top, Bottom, Left, and Right. 3ds Max starts up with the Top, Front, and Left orthographic viewports visible. The left label in the top-left corner of the viewport displays the viewport name. This label is called the Point-of-View viewport label. The fourth default viewport is a perspective view. Only one viewport, known as the *active viewport*, is enabled at a time. A yellow border highlights the active viewport.

Figure 2.2 shows the viewports with a cartoon chicken. You can see the model from a different direction in each viewport. If you want to measure the chicken's beak, you could get an accurate measurement using the Top or Right viewport, whereas you can use the Front and Right viewports to measure its precise height. Using these different viewports, you can accurately work with all object dimensions.

FIGURE 2.2

The 3ds Max interface includes four viewports, each with a different view.

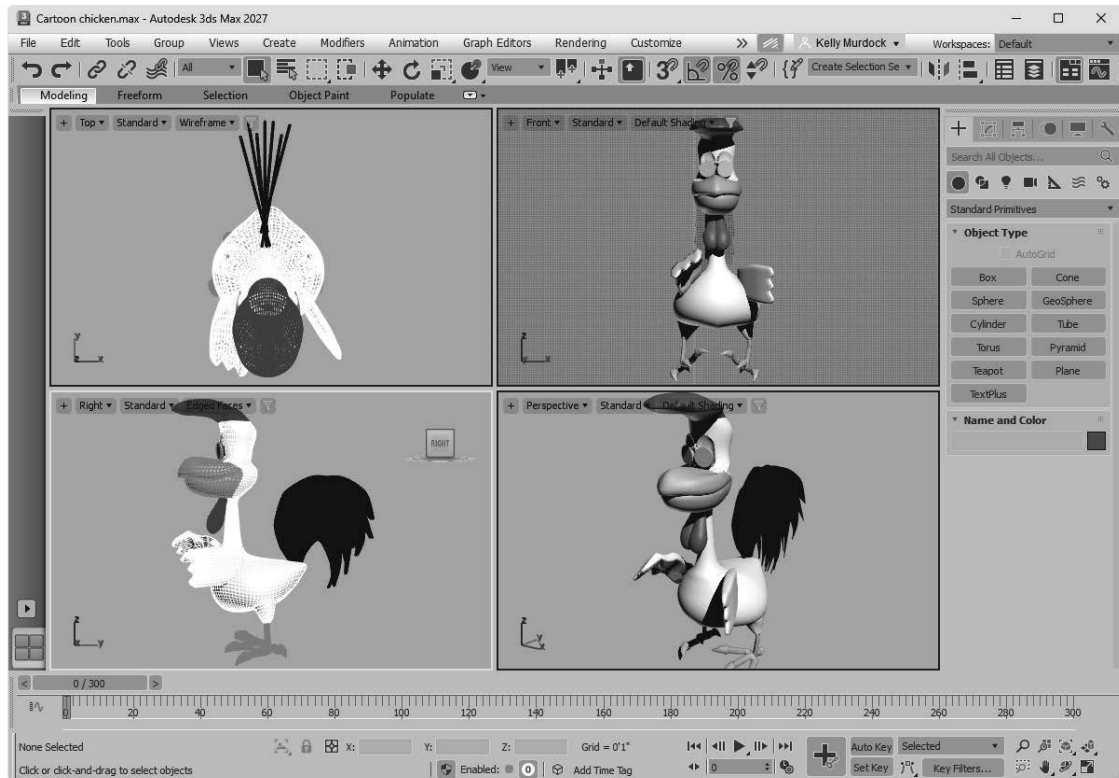

Isometric views in 3ds Max are called orthographic viewports. You can create an orthographic viewport by rotating any of the default non-perspective views.

Tip

3ds Max includes several keyboard shortcuts for quickly changing the view in the active viewport, including T (Top view), B (Bottom view), F (Front view), L (Left view), C (Camera view), \$ (Spotlight view), P (Perspective view), and U (Orthographic User view). Pressing the V key opens a quad menu that lets you select a new view.

Using the Navigation Gizmos

One of the key advantages of working in 3D is that you can view your models from an endless number of viewpoints, but you won't be able to switch to these endless viewpoints until you learn to navigate the viewports. Being able to quickly navigate the viewports is essential to working in 3ds Max and one of the first skills you should master.

To make the process of navigating within the viewports and switching among the various views easier, 3ds Max has some navigation gizmos that make this chore easy. These semitransparent gizmos hover in the

upper-right corner of each viewport and provide a way to change the view without having to access a tool, select a menu, or even use a keyboard shortcut.

Working with the ViewCube

The ViewCube consists of a 3D cube that is labeled on each side and centered in a ring aligned with the ground plane. Its purpose is to show the current orientation of the viewport, but it is also interactive and provides a way to quickly move among the different views.

If you drag the cursor over the top of the ViewCube, shown in Figure 2.3, you'll notice that the cube's faces, corners, and edges are highlighted as the cursor moves over them. If you click when any of the cube's parts are highlighted, the viewport is animated and moves to the new view, so it's positioned as if it's pointing at the selected part. By slowly animating the transition to the new view, you get a better idea of the size and shape of the model. It also makes it easy to reorient the model if it gets twisted around to an odd angle. For example, if you click the cube's face labeled Top, the view moves from its current view to the same orientation as the top view.

FIGURE 2.3

The ViewCube lets you quickly change the current view.

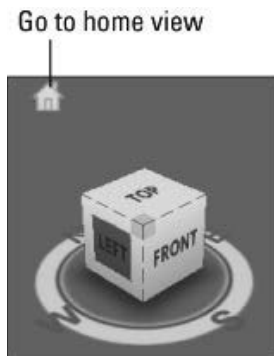

The ViewCube also lets you click and drag on the cube to rotate the view around. The scene rotates along with the ViewCube. You also can click and drag on the base ring to spin the model about its current orientation. When you hover over the ViewCube, a small house icon appears. Clicking this icon changes the view to the defined home view. You can set the Home view by right-clicking the ViewCube and selecting the Set Current View as Home option from the pop-up menu. These same menu options also are available in the Views→ViewCube menu and as an option in the General Viewport label (the small plus sign located in the upper-left corner of each viewport). If the ViewCube isn't visible, you can enable it using the Views→ViewCube→Show For Active View. Another option is to Show For All Views.

Other pop-up menu options let you switch the view between orthographic and perspective views. You also can set the current view as Front, reset the Front view, and open the ViewCube panel that is located in the Viewport Configuration dialog box with the Configure option.

The ViewCube panel in the Viewport Configuration dialog box includes settings for turning the ViewCube on and off In All Views in Active Layout or In Only the Active View. You also can set the ViewCube size and its inactive opacity.

Tip

If you like the ViewCube but feel that it takes up too much of the viewport, you can change its size to Small or Tiny, or you can set its inactive opacity to 0. When its inactive opacity is set to 0, the ViewCube isn't visible at all until you move the cursor over its location, causing it to appear.

The ViewCube panel in the Viewport Configuration dialog box also has options to control what happens when you click or drag the ViewCube. You can snap to the closest view when dragging the ViewCube, and you have options to automatically make the models fit to the view when the view changes, to use animated transitions, and to keep the scene upright. If you find that the view keeps ending up at odd angles when you drag the ViewCube, try enabling the Keep Scene Upright option. Finally, you have an option to display the compass under the ViewCube and a setting for the Angle of North so you can change the compass' orientation. The compass is helpful in being able to spin the model around, but if your model is something like a planet that doesn't have a top or bottom, disabling the compass makes sense.

Using the SteeringWheels

The ViewCube is great for switching between the default views and for rotating the current view, but there are many additional navigation tools that aren't covered with the ViewCube. To handle many of these other navigation tools, such as zooming and panning, 3ds Max includes the SteeringWheels, another gizmo for navigating the viewports.

When 3ds Max is first started, the SteeringWheels are turned off, but you can enable this gizmo with the Views→SteeringWheels menu, the SteeringWheels→Toggle SteeringWheels menu in the General Viewport menu or by pressing the Shift+W shortcut. The SteeringWheels menu also is found in the General Viewport label (the + sign label), located in the upper-left corner of the viewport. Once enabled, this gizmo follows your mouse cursor around as it moves about the viewport, and different parts of the wheel are highlighted when you move over them. If you click and drag while a section of the SteeringWheels is highlighted, you can access that control. Right-clicking at any time will open the SteeringWheels menu and pressing the Escape key will toggle the SteeringWheels off again. There are several different modes for the SteeringWheels in both full-size and mini versions, including the Full Navigation Wheel, with all commands; the View Object Wheel, with commands for navigating about objects; and the Tour Building Wheel, for walking through buildings. The Full Navigation Wheel, shown in Figure 2.4, includes the following modes:

FIGURE 2.4

The SteeringWheel gizmo includes several different ways to navigate the viewports.

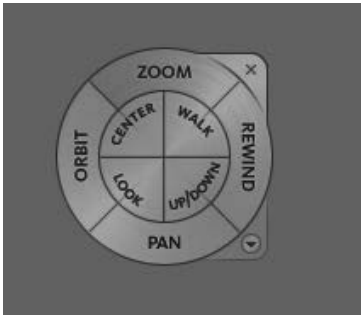

- * **Zoom:** This causes the view to zoom in and out of the scene about the pivot. The Zoom pivot is set at the position of the mouse cursor in the scene when you click the Zoom button.
- * **Orbit:** This causes the view to orbit about the pivot. The pivot is set by clicking and dragging on the Center button.
- * **Pan:** This causes the view to pan in the direction that you drag the cursor.
- * **Rewind:** As you change the scene, 3ds Max remembers each view where you stop and keeps these views in a buffer. The Rewind mode displays these views as small thumbnails, as shown in Figure 2.5, and lets you move through them by dragging the mouse. This allows you to rewind and move forward through the buffered views.

Tip

Moving between the buffered thumbnail views with the Rewind feature gradually animates the transition between adjacent thumbnails and allows you to click to change the view to one that is between two buffered views.

FIGURE 2.5

Rewind mode lets you move back and forth through recent views.

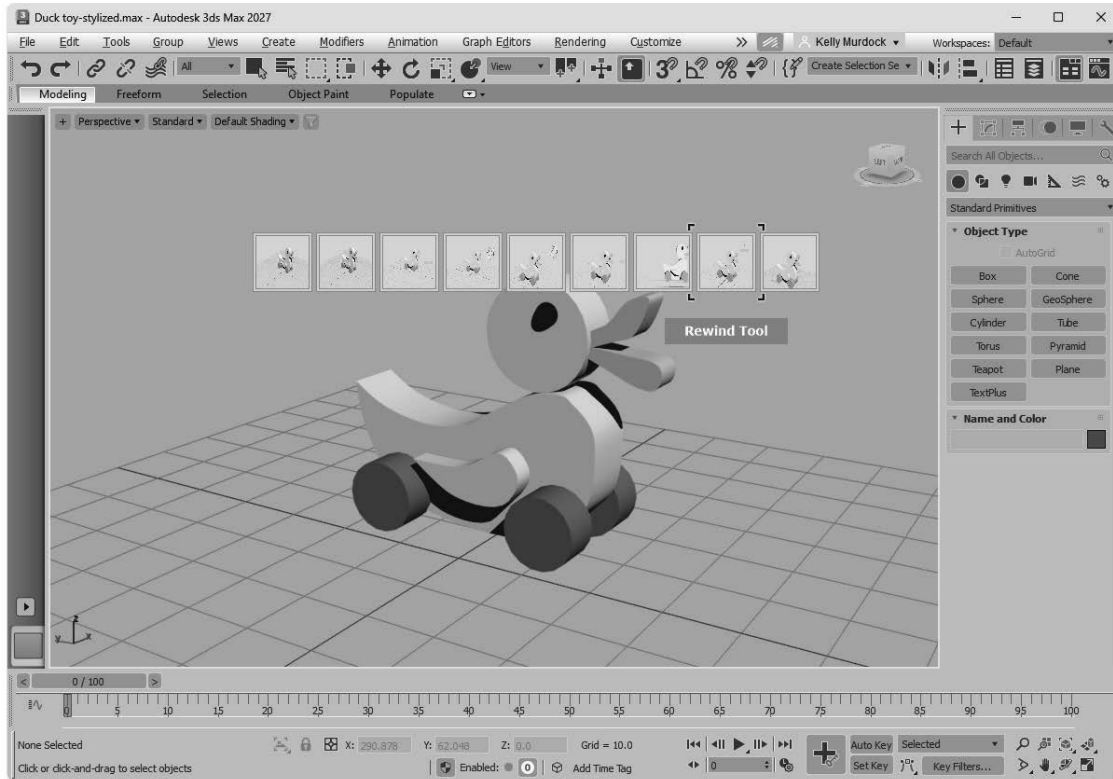

- * **Center:** This lets you click an object to be the pivot center for zooming and orbiting.
- * **Walk:** This moves you forward through the scene as if you were walking through it by holding down the left mouse button and moving the mouse.
- * **Look:** This causes the camera to rotate side to side as if looking to the side.
- * **Up/Down:** This moves the view up and down from the current location.

Note

It is covered later in the chapter, but you can maximize the active viewport by clicking the Maximize Viewport Toggle button (the button in the lower-right corner of the interface) or by pressing Alt+W.

In the upper-right corner of the wheel is a small X icon. This icon is used to close the SteeringWheels gizmo. In the lower-right corner of the wheel is a small down arrow. This icon opens a pop-up menu. Using the pop-up menu, you can select a different wheel type, go to the Home view as defined by the ViewCube, increase or decrease the walk speed, restore the original center, or open the SteeringWheels panel in the Viewport Configuration dialog box. These same options are also available in the SteeringWheels menu in the General viewport label, along with an option to Toggle the SteeringWheels on and off (Shift+W).

Using the SteeringWheels panel in the Viewport Configuration dialog box, you can set the size and opacity of the SteeringWheels. Settings for controlling many of the different modes are available as well.

Tutorial: Navigating the active viewport

Over time, navigating the viewports becomes second nature to you, but you need to practice to get to that point. In this tutorial, you get a chance to take the viewports for a spin—literally.

To practice navigating a viewport, follow these steps:

1. Open the Little Dragon.max file from the Chap 02 directory in the downloaded content set. This file includes a model of a cartoon dragon. It provides a reference as you navigate the viewport. The active viewport is the Perspective viewport.
2. Click the Maximize Viewport Toggle button (or press Alt+W) to make the Perspective viewport fill the space of all four viewports.
3. Click the Front face in the ViewCube to transition the view to the front view. Then move the cursor over the upper-right corner of the ViewCube, and click to return the view to an angled view.
4. Select the SteeringWheels→Toggle SteeringWheels from the General viewport menu in the upper left corner of the active viewport; then hold down the Ctrl key when over the Zoom section of the Steering Wheel and click on little dragon's head to set the pivot. Then move the cursor over the Zoom button, and drag until the head fills the viewport.
5. With the SteeringWheels still active, move the cursor over the Pan button, and drag the window until the dragon's head is centered evenly in the viewport, as shown in Figure 2.6. Click on the small X button in the upper right corner of the Steering Wheel to toggle the SteeringWheels gizmo off.

FIGURE 2.6

The Perspective viewport is zoomed in on the dragon's head using the Zoom and Pan controls.

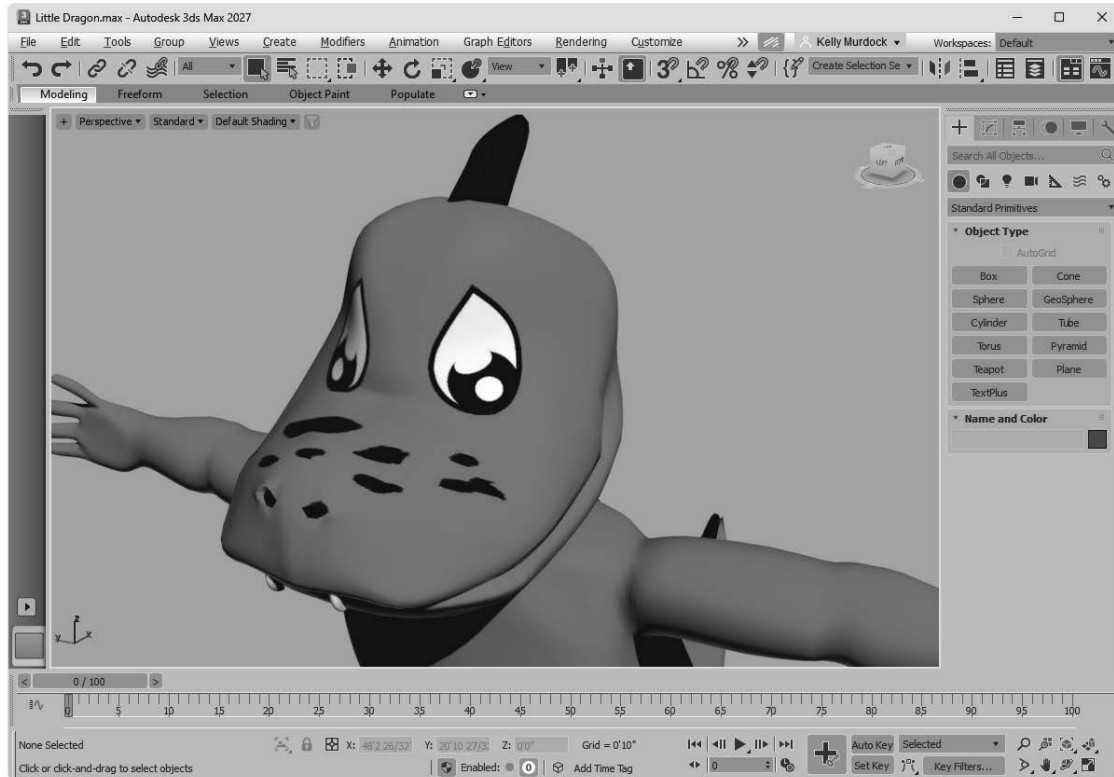

Controlling Viewports with a Scroll Wheel Mouse

Now that I've explained the viewport navigation gizmos, I'll explain another easy way to control the viewports. Often, the quickest way to control the viewports is with the mouse. To really get the benefit of the mouse, you need to use a mouse with a scroll wheel (which also acts as a middle mouse button).

Rolling the scroll wheel in the active viewport zooms in to and out of the viewport by steps just like the bracket keys ([and]). You can zoom gradually by holding down Ctrl+Alt while dragging the scroll wheel.

Clicking and dragging the scroll wheel button pans the active viewport. Clicking and dragging the scroll wheel button with the Alt button held down rotates the active viewport.

Caution









Be careful when zooming in with the scroll wheel. If you zoom in too far, the zooming becomes unstable. If this happens, you can select the Undo View Change (Shift+Z) command to undo the zoom or use the Zoom Extents button.

Using the Viewport Navigation Controls

Although the ViewCube, the SteeringWheels, and the scroll wheel make navigating the viewports easy, you can still use the standard navigation tools located in the bottom-right corner of the interface. The standard viewports show you several different views of your current project, but within each viewport, you can zoom in on certain objects, pan the view, or rotate about the center of the viewport. Clicking a viewport with any

of the Viewport Navigation Controls automatically makes the selected viewport the active viewport. In Table 2.1, the keyboard shortcut for each button is listed in parentheses next to its name.

TABLE 2.1 Viewport Navigation Controls

Toolbar Button	Name	Description
	Zoom (Alt+Z or [or])	Moves closer to or farther from the objects in the active viewport by dragging the mouse or zooming by steps with the bracket keys.
	Zoom All	Zooms in to or out of all the viewports simultaneously by dragging the mouse.
	Zoom Extents (Ctrl+Alt+Z), Zoom Extents Selected (Z)	Zooms in on all objects or just the selected object until it fills the active viewport.
	Zoom Extents All (Ctrl+Shift+Z), Zoom Extents All Selected	Zooms in on all objects or just the selected object until it fills all the viewports.
	Field of View, Zoom Region (Ctrl+W)	The Field of View button (available only in the perspective view) controls the width of the view. The Zoom Region button zooms in to the region selected by dragging the mouse.
	Pan View (Ctrl+P or I), 2D Pan Zoom, Walk Through (Up arrow)	Moves the view to the left, to the right, up, or down by dragging the mouse or by moving the mouse while holding down the I key. The Walk Through feature moves through the scene using the arrow keys or a mouse like a first-person video game.
	Orbit (Ctrl+R), Orbit Selected, Orbit SubObject, Orbit Point of Interest	Rotates the view around the global axis, selected object, subobject, or point of interest by dragging the mouse.
	Maximize Viewport Toggle (Alt+W)	Makes the active viewport fill the screen, replacing the four separate viewports. Clicking this button a second time shows all four viewports again.

Caution

When one of the Viewport Navigation buttons is selected, it is highlighted light blue. You cannot select, create, or transform objects while one of these buttons is highlighted. Right-clicking in the active viewport or clicking the Select Objects tool reverts to select object mode.

Zooming a view

You can zoom into and out of the scene in several ways. Clicking the Zoom (Alt+Z) button enters zoom mode, where you can zoom into and out of a viewport by dragging the mouse. This works in whichever viewport you drag in. To the right of the Zoom button is the Zoom All button, which does the same thing as the Zoom button, only to all four viewports at once. If you hold down the Ctrl key while dragging in Zoom mode, the zoom action happens more quickly, requiring only a small mouse movement to get a large zoom amount. Holding down the Alt key while dragging in Zoom mode has the opposite effect; the zoom happens much more slowly, and a large mouse move is required for a small zoom amount. This is helpful for fine-tuning the zoom.

The Zoom Extents (Ctrl+Alt+Z) button zooms the active viewport so that all objects (or the selected objects with the Zoom Extents Selected button) are visible in the viewport. A Zoom Extents All (Ctrl+Shift+Z) button is available for zooming in all viewports to all objects' extents; the most popular zoom command

(and the easiest to remember) is Zoom Extents Selected (Z), which is for zooming in to the extents of the selected objects in the active viewport.

You can use the brackets keys to zoom in ([) and out (]) by steps. Each key press zooms in (or out) another step. The Zoom Region (Ctrl+W) button lets you drag over the region that you want to zoom in on. If you select a non-orthogonal view, such as the Perspective view, the Zoom Region button has a flyout called the Field of View. Using this button, you can control how wide or narrow the view is. This is like using a wide angle or telephoto lens on your camera. This feature is different from zoom in that the perspective is distorted as the Field of View is increased.

Field of View is covered in more detail in Chapter 18, “Configuring Cameras and Environments.”

Panning a view

The Viewport Navigation Controls also offer two ways to pan in a viewport. In Pan View mode (Ctrl+P), dragging in a viewport pans the view. Note that this doesn't move the objects, only the view. In addition, the Ctrl and Alt keys can be held down to speed or slow the panning motions. The second way to pan is to hold down the I key while moving the mouse. This is known as an *interactive* pan.

Walking through a view

The Walk Through button (instantly accessed with the Up arrow button), found as a flyout button under the Pan View button, allows you to move through the scene in the Perspective or Camera viewport using the arrow keys or the mouse just as you would if you were playing a first-person computer game. When this button is active, the cursor changes to a small circle with an arrow inside it that points in the direction you are moving. You need to click in the viewport before you can use the arrow keys.

Caution

The Pan View button is a flyout only if the Perspective view or a Camera view is selected.

The Walk Through feature includes several keystrokes for controlling the camera's movement. The arrow keys move the camera forward, left, back, and right (or you can use the W, A, S, and D keys). You can toggle the speed of the motion with the Q (speed up) and Z (speed down) keys or with the [(decrease step size) and] (increase step size) keys. The E and C keys (or the Shift+up and Shift+down arrows) are used to move up and down in the scene. The Shift+spacebar key causes the camera to be set level. Dragging the mouse while the camera is moving changes the direction in which the camera points.

Caution

To use the W, A, S, and D keys for walk-through mode, make sure that the Keyboard Shortcut Override Toggle on the main toolbar is enabled.

A handy alternative to Walk Through mode is the Walkthrough Assistant, which is found on the Animation menu. This utility opens a dialog box that includes buttons for creating and adding a camera to a path. It also has controls for turning the view side to side as the camera moves along the path.

The Walkthrough Assistant is covered in more detail in Chapter 23, “Animating with Constraints and Simple Controllers.”

Rotating a view

Rotating the view can be the most revealing of all the view changes. When the Orbit (Ctrl+R) button is selected, a rotation guide appears in the active viewport, as shown in Figure 2.7. This rotation guide is a circle with a square located at each quadrant. Clicking and dragging the left or right squares rotates the view side to side; the same action with the top and bottom squares rotates the view up and down. Clicking within the circle and dragging rotates within a single plane, and clicking and dragging outside the circle rotates the view about the circle's center either clockwise or counterclockwise. If you get confused, look at the cursor,

which changes depending on the type of rotation. The Ctrl and Alt keys also can speed and slow the rotating view.

Within the Viewport Navigation Controls are several flyout options for rotating the scene. Using the Orbit Selection mode, you can orbit about the selected object. There are also options for orbiting about the selected subobject and about the cursor's location (known as the point of interest).

Note

The Orbit keyboard shortcut (Ctrl+R) selects whichever Orbit tool was the last to be used.

FIGURE 2.7

The rotation guide appears whenever the Orbit tool is selected.

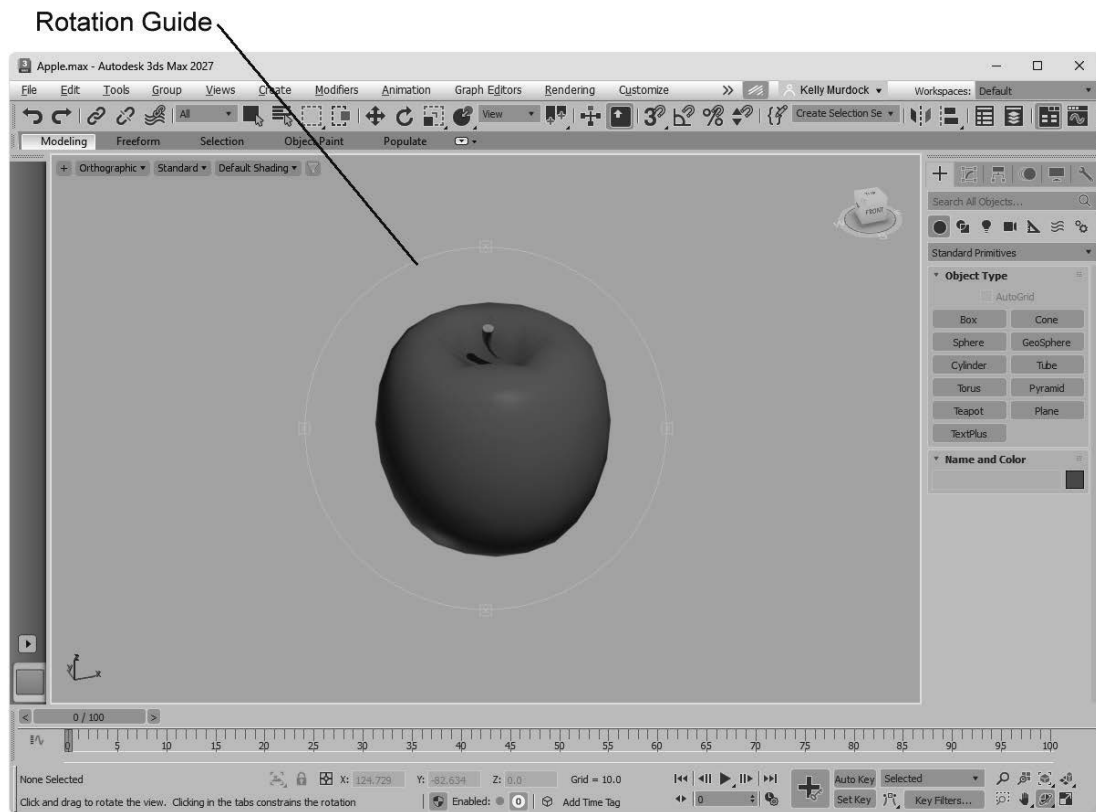

Note

If you rotate one of the default non-perspective views, it automatically becomes an orthographic view, but you can undo the change using the Undo View Change command in the Views menu or the Shift+Z shortcut.

Maximizing the active viewport

Sooner or later, the viewports will feel too small. When this happens, you have several ways to increase the size of your viewports. The first trick to try is to change the viewport sizes by clicking and dragging any of the viewport borders. Dragging on the intersection of the viewports resizes all the viewports. Figure 2.8 shows the viewports after being dynamically resized.

Tip

You can return to the original layout by right-clicking any of the viewport borders and selecting Reset Layout from the pop-up menu.

FIGURE 2.8

You can dynamically resize viewports by dragging their borders.

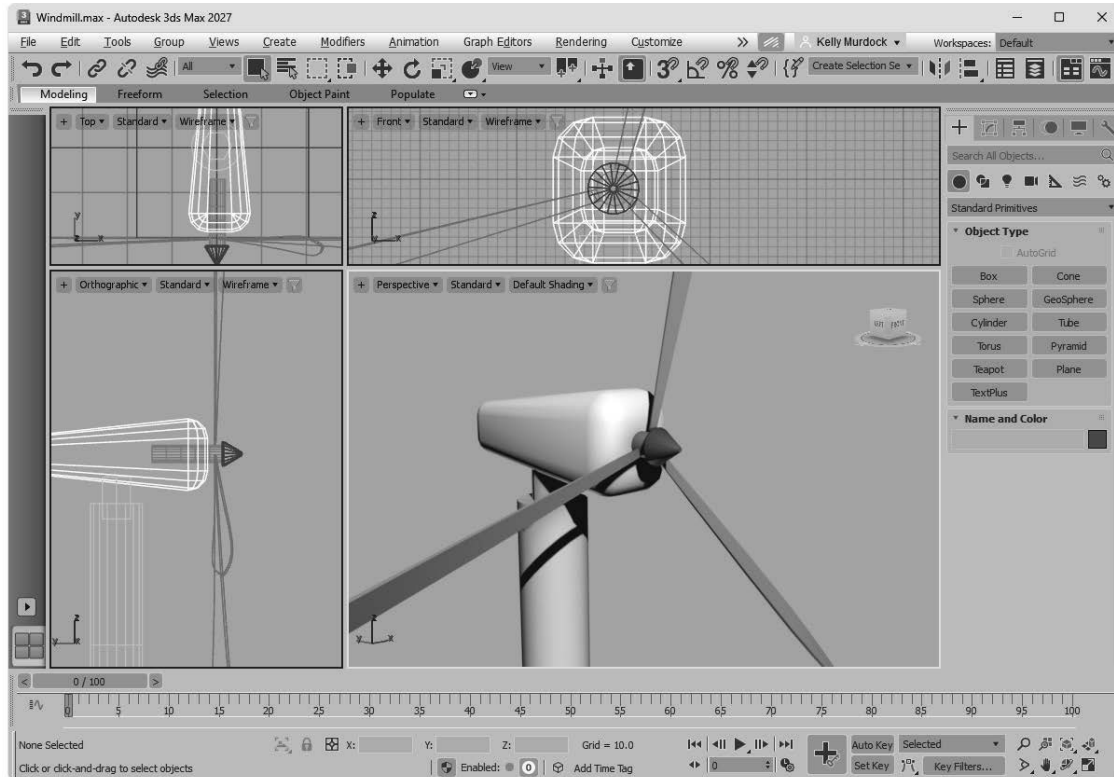

The second trick is to use the Maximize Viewport Toggle (Alt+W) to expand the active viewport to fill the space reserved for all four viewports. Clicking the Maximize Viewport Toggle (or pressing Alt+W) a second time returns to the defined layout.

Maximizing the viewport helps temporarily, but you can take another step before convincing your boss that you need a larger monitor. You can enter Expert Mode by choosing Views→Expert Mode (Ctrl+X). It maximizes the viewport space by removing the main toolbar, the Command Panel, and most of the lower interface bar.

With most of the interface elements gone, you'll need to rely on the menus, keyboard shortcuts, and quad menus to execute commands. To re-enable the default interface, select the Views→Expert Mode menu again (or press Ctrl+X again). Figure 2.9 shows the interface in Expert Mode.

FIGURE 2.9

Expert Mode maximizes the viewports by eliminating most of the interface elements.

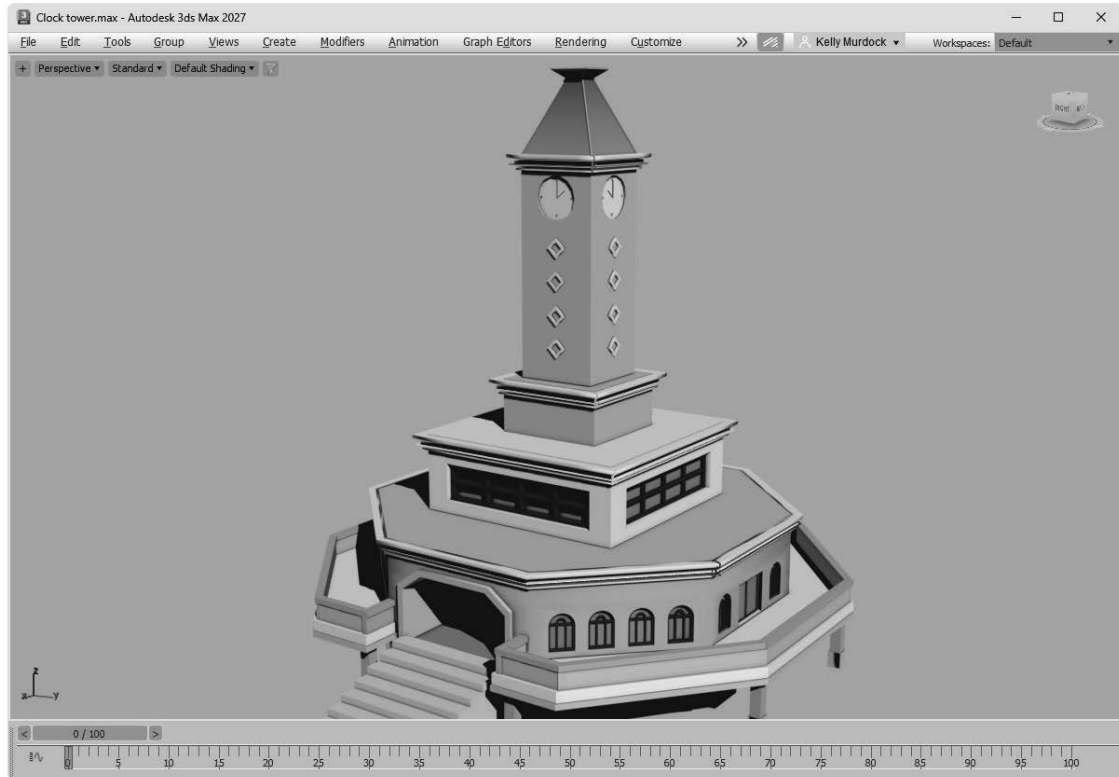

Controlling camera and spotlight views

You can set any viewport to be a camera view (C) or a spotlight view (\$) if a camera or a spotlight exists in the scene. When either of these views is active, the Viewport Navigation Control buttons change. In camera view, controls for dolly, roll, truck, pan, orbit, and field of view become active. A light view includes controls for the falloff and hotspots.

Chapter 18, “Configuring Cameras and Environments,” and Chapter 19, “Using Lights and Basic Lighting Techniques,” cover these changes in more detail.

Setting the navigation controls to match Maya

In many studios, you’ll find both 3ds Max and Maya. These software packages have different navigation controls, but you can set 3ds Max to mimic the Maya controls using the Interaction Mode panel in the Preference Settings dialog box. This panel includes a simple drop-down box for switching the viewport navigation controls between 3ds Max and Maya. If you make the change, the designated controls will be used automatically the next time you start up the software.

Table 2.2 shows the basic keyboard and mouse navigation controls for both 3ds Max and Maya.

TABLE 2.2 Viewport Navigation Controls for 3ds Max and Maya

Viewport Navigation Control	3ds Max	Maya
Rotate View	Alt+middle mouse button	Alt+left mouse button
Pan View	middle mouse button	Alt+middle mouse button
Zoom View	scrub scroll wheel	Alt+right mouse button
Zoom Extents Selected	Z	F
Zoom Extents All	Shift+Ctrl+Z	A
Maximize Viewport	Alt+W	spacebar
Undo/Redo Viewport Change	Shift+Z/Shift+Y	Alt+Z/Alt+Y

Changing the Viewport Display

Although the Viewport Navigation Controls are focused on controlling what is visible in the viewports, a number of useful commands are available in the Views menu and in the viewport labels at the top-left corner of each viewport that directly affect the viewports. The four viewport labels, shown in Figure 2.10, include the General viewport label (which is a simple plus sign), the Point-of-View viewport label, the Shading Quality viewport label and the Per-View Preference viewport label. The last two labels show the current setting.

Within the Views menu and the viewport labels are options to configure the viewports using the Viewport Configuration dialog box.

FIGURE 2.10

Viewport labels in the upper-left corner of each viewport hold settings for that particular viewport.

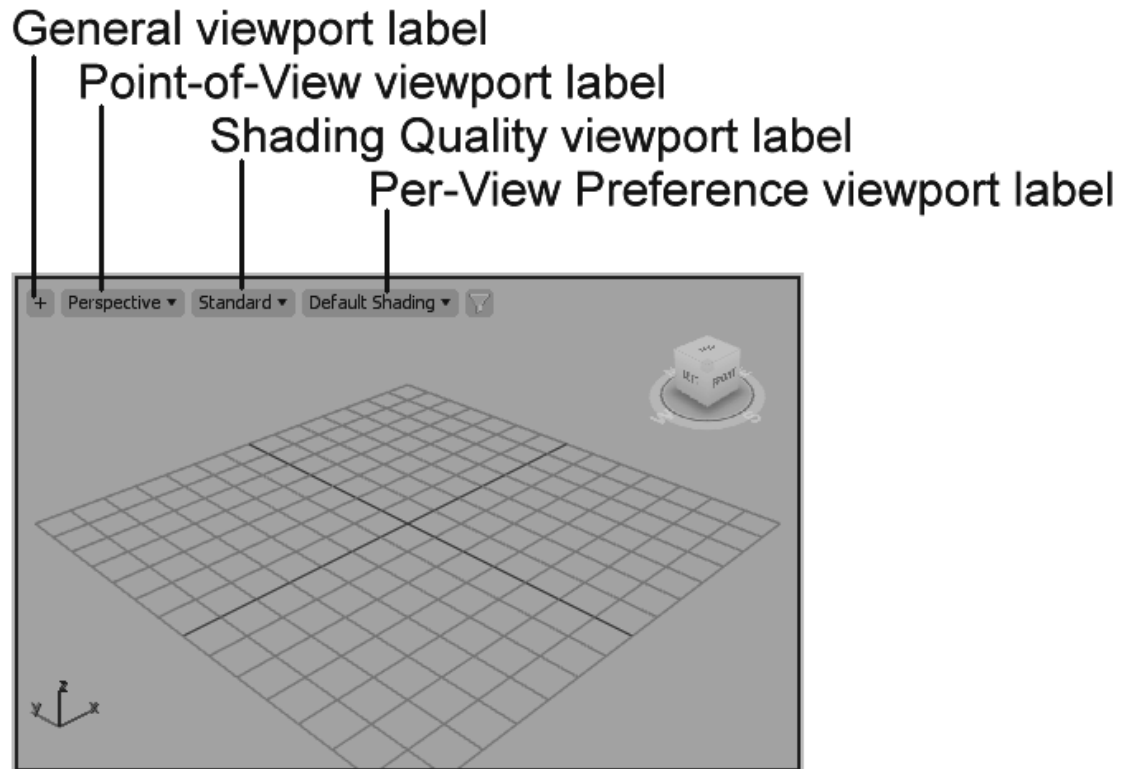

Undoing and saving viewport changes

If you get lost in your view, you can undo and redo viewport changes with Undo View Change (Shift+Z) and Redo View Change (Shift+Y). These same commands also are available at the bottom of the Point-of-View viewport label. These commands are different from the Edit→Undo and Edit→Redo commands, which can undo or redo geometry changes.

You can save changes made to a viewport by using the Save Active Viewport menu command in the Views viewport menu. This command saves the Viewport Navigation settings for recall. To restore these settings, use Restore Active Viewport.

Note

The Save and Restore Active Viewport commands do not save any viewport configuration settings, just the navigated view. Saving an active view uses a buffer, so it remembers only one view for each viewport.

Disabling and refreshing viewports

If your scene gets too complicated, you can experience some slowdown waiting for each viewport to be updated with changes, but fear not, because several options will come to your rescue. The first option to try is to disable a viewport.

You can disable a viewport by clicking the General viewport label and selecting the Disable View menu command from the pop-up menu, or you can press the keyboard shortcut, Shift+Ctrl+D. When a disabled viewport is active, it is updated as normal; when it is inactive, the viewport is not updated at all until it

becomes active again. Disabled viewports are identified by the word *Disabled*, which appears next to the viewport's labels in the upper-left corner.

Another trick to increase the viewport update speed is to disable the Views→Update During Spinner Drag menu option. Changing parameter spinners can cause a slowdown by requiring every viewport to update as the spinner changes. If the spinner is changing rapidly, it can really slow even a powerful system. Disabling this option causes the viewport to wait for the spinner to stop changing before updating.

Sometimes when changes are made, the viewports aren't completely refreshed. This typically happens when dialog boxes from other programs are moved in front of the viewports or as objects get moved around, because they often mask one another and lines disappear. If this happens, you can force 3ds Max to refresh all the viewports with the Views→Redraw All Views (keyboard shortcut, `) menu command. The Redraw All Views command refreshes each viewport and makes everything visible again.

Floating viewports

At the bottom of the viewport's General label menu are three options to make the current viewport floating in the Float Viewport menu. This option doesn't remove the current docked viewport, but simply makes a copy of the current viewport and makes it floating. Floating viewports can be moved as needed and still have the same configuration menu options.

Setting the viewport visual style

Complex scenes take longer to display and render. The renderer used for the viewports is highly optimized to be very quick, but if you're working on a huge model with lots of complex textures and every viewport is set to display the highest-quality view, updating each viewport can slow the program to a crawl.

By default, all the orthographic views are set to wireframe, and only the perspective view is set to show shading, but the Per-View Preference viewport label includes several options that let you set the visual style settings for the current viewport.

Tip

If you ever get stuck waiting for 3ds Max to complete a task, such as redrawing the viewports, you can always press the Escape key to suspend any task immediately and return control to the interface.

Note

These settings have no effect on the final rendering specified using the Rendering menu. They affect only the display in the viewport.

The Rendering Level options include the following:

- * **Default Shading:** Shows smooth surfaces with lighting highlights
- * **Facets:** Shows each face as a flat surface without smoothing the edges
- * **Bounding Box:** Shows a box that would enclose the object
- * **Flat Color:** Shows the entire object with minimal lighting
- * **Hidden Line:** Shows only polygon edges facing the camera
- * **Clay:** Shows the surface as red modeling clay, which is helpful for seeing deformations
- * **Model Assist:** Shades each face to see the flow of the object, but only works for Editable Poly objects.
- * **Stylized:** Includes artistic options such as Graphite, Color Pencil, Ink, Color Ink, Acrylic, Pastel, and Tech
- * **Wireframe Override:** Shows the scene as wireframes.
- * **Edged Faces:** An option applied in addition to the shading method that shows all edge segments.

Although they really aren't a rendering method, the Wireframe Override and Edged Faces options can be used to enhance the selected shading method. The Wireframe Override option toggles all the wireframe lines

on and off, and the Edged Faces option shows the edges for each face when a shaded rendering method is selected. You can enable and disable the Edged Faces option with the F4 keyboard shortcut. Figure 2.11 shows, side by side, all the various viewport rendering methods applied to a simple sphere.

FIGURE 2.11

The viewport rendering methods are shown from left to right. First row: Default, Shaded, Flat Color, Facets, and Hidden Line. Second row: Wireframe, Bounding Box, Clay, and Edged Faces applied to Shaded.

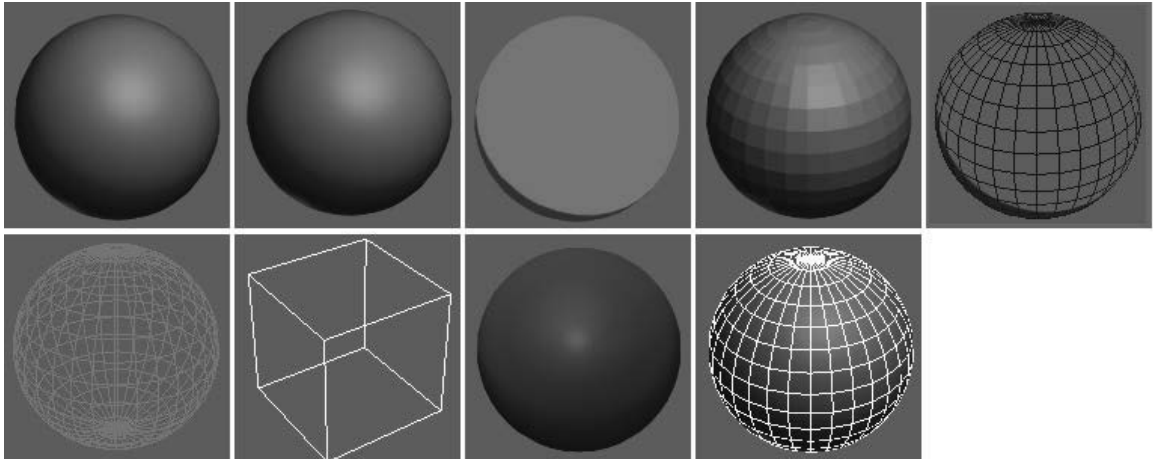

The default shading method uses any applied textures and high-quality lighting and shadows. The Flat Color method displays the entire object using a single color without any shading. The simplest rendering setting that represents the shape of the object is Wireframe. It gives a good representation of the object while redrawing very quickly. By default, the Top, Front, and Left viewports are set to Wireframe, and the Perspective viewport is set to Default Shading. The Bounding Box method shows only the limits of the object as a rectangular box.

Note

Many material effects, such as bump and displacement maps, cannot be seen in the viewport and show up only in the final render.

Viewing stylized scenes

Stylized non-photorealistic effects often are not as computationally complex as realistic renderings, and as such, they can be enabled and displayed within the viewports as well as rendered images. Although you probably would not want to work in one of these stylized display modes, you can use the Per-View Preference viewport label to access a menu of available stylized display options.

The options include Graphite, Color Pencil, Ink, Color Ink, Acrylic, Pastel, and Tech. Figure 2.12 shows the clock tower model with the Color Ink option.

FIGURE 2.12

The clock tower scene is displayed using the Colored Ink display style.

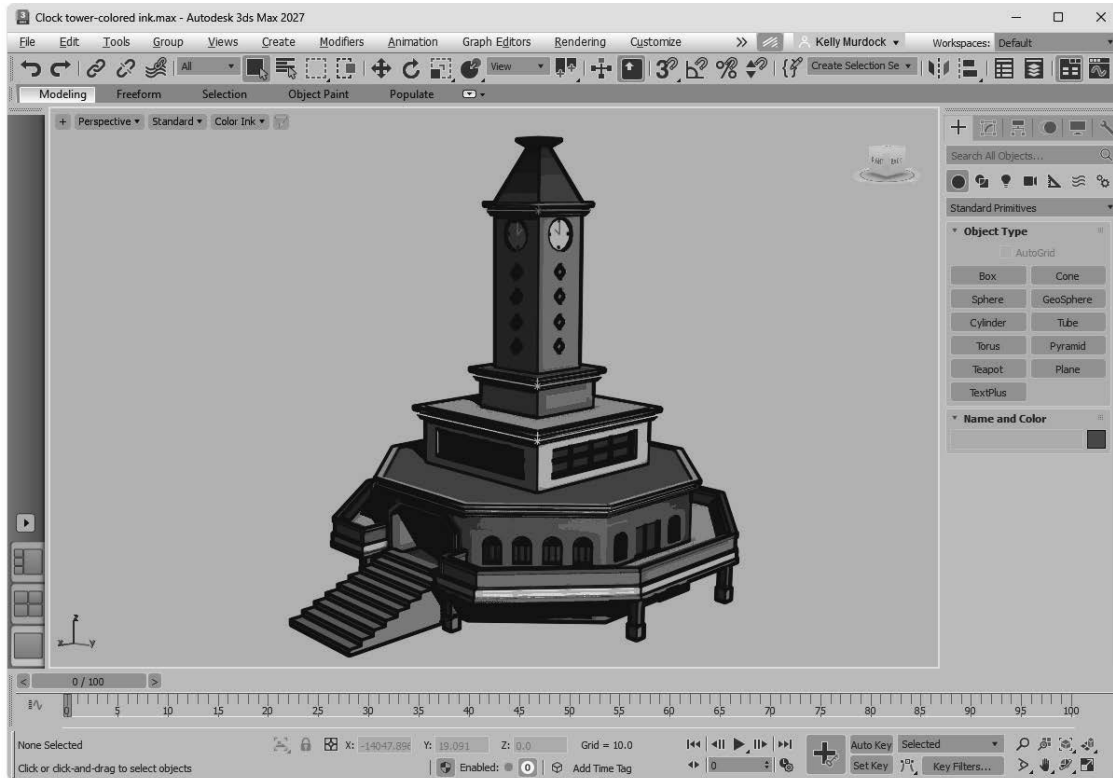

The various stylized display options also can be set in the Preferences panel in the Viewport Settings dialog box.

Enhancing the Viewport

In addition to changing the viewport display, several options allow for changing the viewport layout or adding information that will help during modeling and animating, such as xView, clipping view, and safe frames. These enhancements help the viewports be even more helpful by presenting information that you need.

Changing the viewport layout

So far, we've used only the default four-pane layout and the maximized viewport, but you can change the viewport layout to have one, two, three, or four panes orientated on top of one another or side by side. The easiest way to switch between the different layouts is with the Viewport Layout Tabs toolbar.

This toolbar is opened by right-clicking on the two lines to the left or top of any toolbar and selecting it from the pop-up menu. You can also access this pop-up menu by right clicking on the menu bar. The toolbar appears by default vertically at the left edge of the viewports, as shown in Figure 2.13. Clicking the Create a New Viewport Layout Tab button opens a panel of several layout options. Selecting one switches the current layout and places the selected layout in the toolbar, where it can quickly be selected again.

FIGURE 2.13

The Viewport Layout Tabs toolbar lets you quickly change between different layouts.

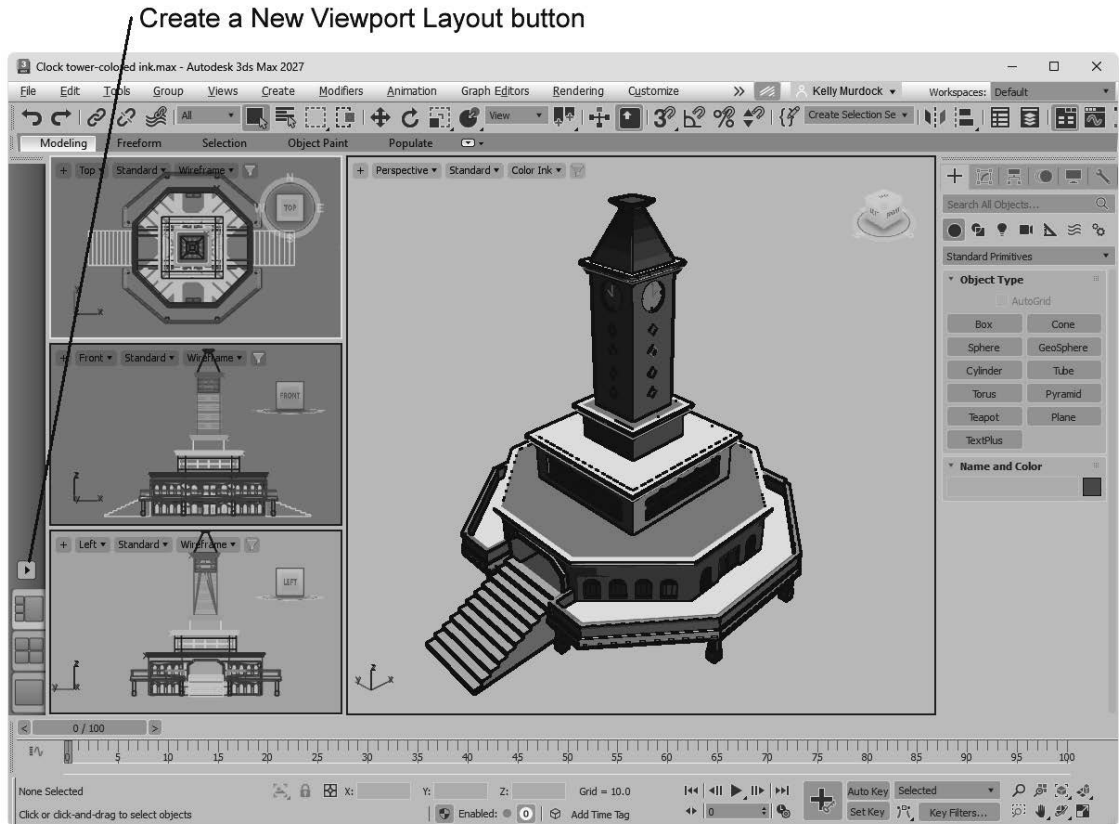

For more options, including the ability to change the view type for each pane, open the Viewport Configuration dialog box using the Views menu, and select the Layout panel. This panel lets you configure each viewport.

The Layout panel, shown in Figure 2.14, in the Viewpoint Configuration dialog box, offers several layouts as alternatives to the default layout (not that there is anything wrong with the default and its four equally sized viewports).

FIGURE 2.14

The Layout panel offers many layout options.

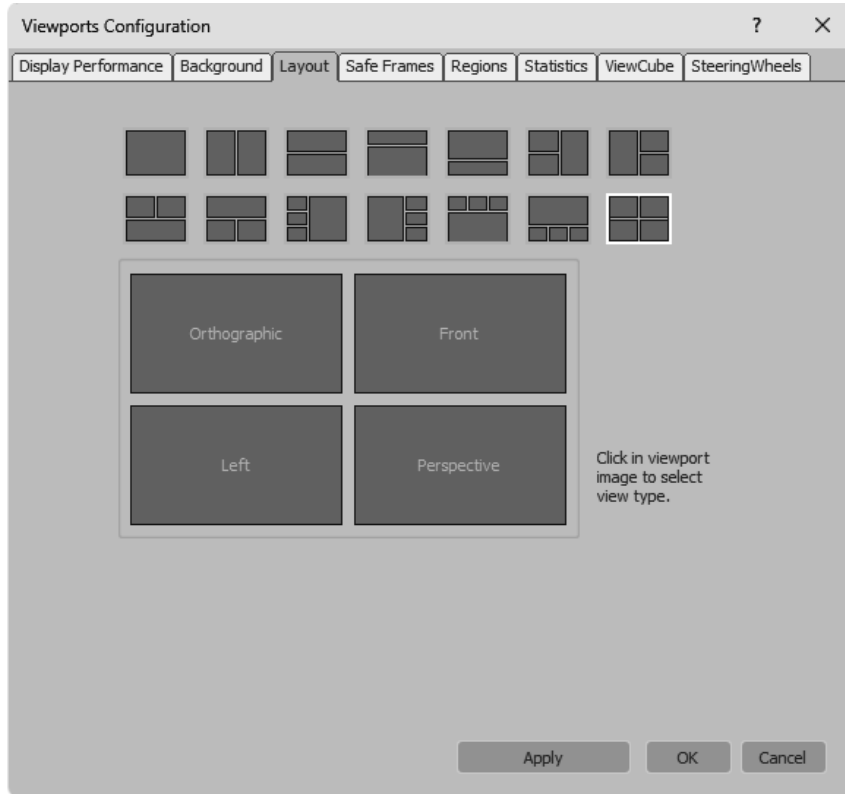

After selecting a layout from the options at the top of the panel, you can assign each individual viewport a different view by clicking each viewport in the Layout panel and choosing a view from the pop-up menu. The view options include the standard Orthographic (such as Top, Front, and Left) and Perspective views, but it also includes options to replace the view with an interface element such as the Track View, the Scene Explorer, or the Material Explorer. These view options are also available by clicking the viewport Point-of-View label in the upper-left corner of the viewport. Figure 2.15 shows a viewport layout with the Track view, Schematic view, Asset Browser, and Perspective views open.

FIGURE 2.15

Other interfaces such as the Track View, Schematic View, and Scene Explorer can be opened within a viewport.

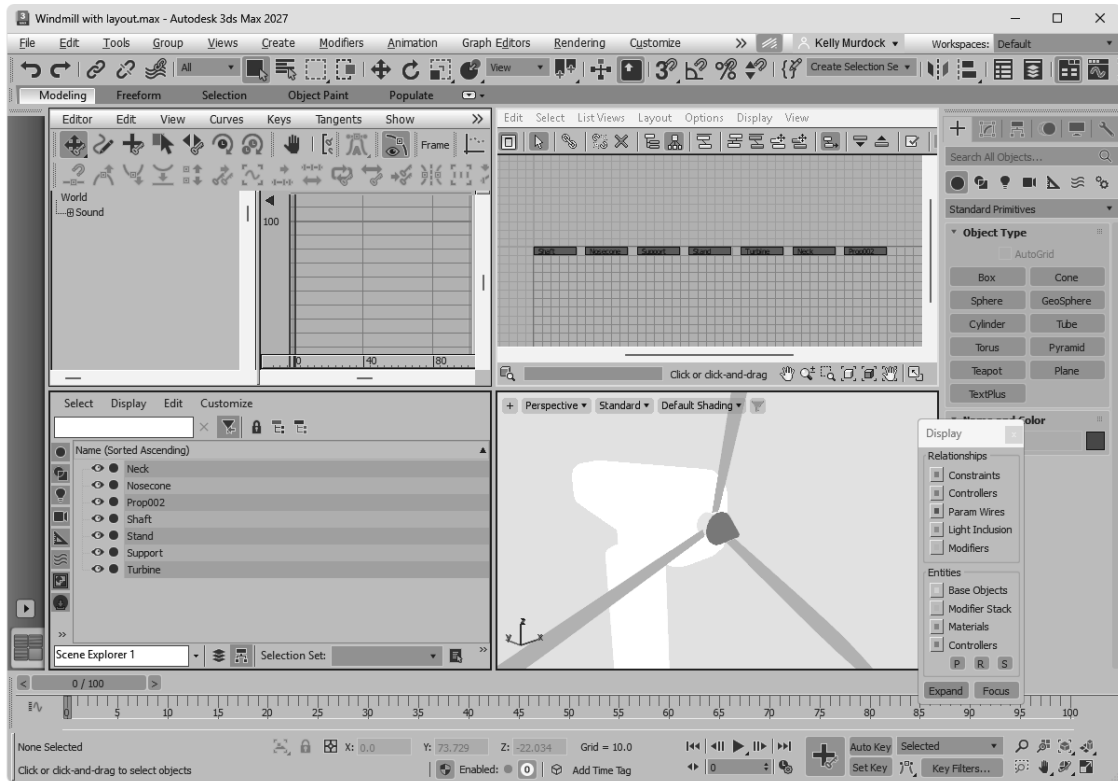

Views also can be set to Cameras and Lights if they exist in the scene. Each camera and light that exists is listed by name at the top of the pop-up menu.

Locating mesh problems with xView

When modeling or importing mesh objects, a number of problems with the geometry can cause rendering artifacts such as flipped normals, overlapping faces, and open edges. Locating these problem areas can be tricky, requiring multiple renders to get it right. Within the viewports is a powerful analysis feature for locating a number of specific problem areas. This feature is called xView, and you can access it from the Views menu and the General viewport label.

The xView analysis tool can locate and highlight the following anomalies:

- * **Show Statistics (7):** Displays the number of Polys, Tris, Edges, Verts, and Frames per Second (FPS) for the entire scene and for the selected object. You can enable/disable each of these stats in the Statistics panel of the Viewport Configuration dialog box.
- * **Face Orientation:** Highlights the back side of the faces in the current selection to quickly identify faces with flipped normals.
- * **Overlapping Faces:** Highlights any faces that are stacked on top of each other, which can cause render problems.
- * **Open Edges:** Identifies unwanted holes in the geometry.
- * **Multiple Edges:** Checks for edges that are stacked on each other. Each edge should be connected to only two faces.

- * **Isolated Vertices:** Highlights vertices that aren't connected to anything. These vertices just take up space.
- * **Overlapping Vertices:** Flags vertices that are within a given tolerance.
- * **T-Vertices:** Highlights vertices where three edges meet. This can terminate an edge loop.
- * **Missing UVW Coordinates:** Shows any faces that have no UVW coordinates for applying textures.
- * **Flipped UVW Faces:** Highlights any faces that are flipped with opposite-pointing normals.
- * **Overlapping UVW Faces:** Displays any faces where the textures are overlapping.

Whichever option is selected is listed at the bottom of the viewport in green, along with the number of offending subobjects, such as Isolated Vertices: 12 Vertices. The xView menu also includes options to Select Results, which provides a way to quickly select and delete problem subobjects like isolated vertices. If the selected option has a setting such as the Tolerance of overlapping edges, you can select the Configure option to set this setting or click the Click Here to Configure text at the bottom of the viewport. Additional menu options allow you to See Through the model, Auto Update the results, and display the results at the top of the viewport.

Tip

If any xView data is displayed in the viewport, you can click it to select another data option. This lets you quickly view all the potential problems with the current object.

By enabling the Show Statistics option, the selected statistics are overlaid on the active viewport, as shown in Figure 2.16. This is helpful for knowing how complex your model is and how many polygons it includes.

FIGURE 2.16

The active viewport can be set to display the selected statistics.

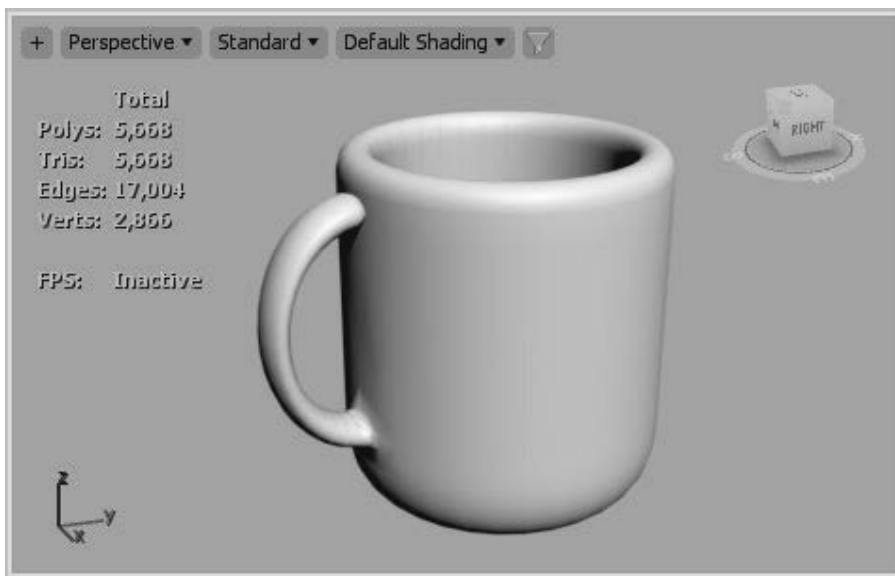

Using clipping planes

Clipping planes define an invisible barrier beyond which all objects are invisible. For example, if you have a scene with many detailed mountain objects in the background, working with an object in front of the scene can be difficult. By setting the clipping plane between the two, you can work on the front objects without having to redraw the mountain objects every time you update the scene. This affects only the viewport, not the rendered output.

Enabling the Viewport Clipping option in the viewport Point-of-View label menu places a light blue line with two arrows on the right side of the viewport, as shown in Figure 2.17. The top arrow represents the back clipping plane, and the bottom arrow is the front clipping plane. Drag the arrows up and down to set the clipping planes.

FIGURE 2.17

The clipping planes can be used to show the interior of this plane model.

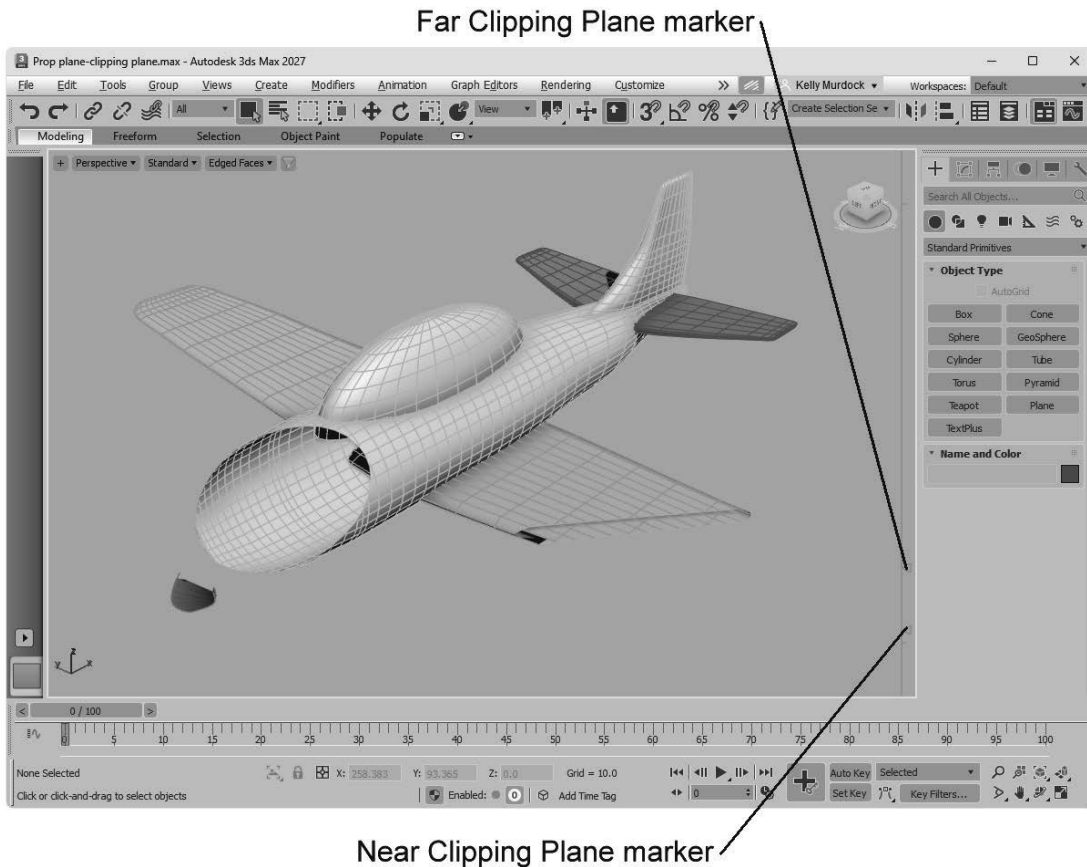

Tutorial: Viewing the interior of a tooth with clipping planes

You can use the Viewport Clipping option in the Point-of-View viewport label to view the interior of a model, such as this tooth model.

To view the interior of a tooth model, follow these steps:

1. Open the Tooth.max file from the Chap 02 directory in the downloaded content set.
2. In the Point-of-View viewport label in the upper-left corner of the viewport, enable the Viewport Clipping option.

The clipping plane markers appear along the right edge of the viewport. The top marker controls the back clipping plane, and the bottom marker controls the front clipping plane.

3. Drag the bottom clipping plane marker upward to slice through the tooth model to reveal its interior, as shown in Figure 2.18.

FIGURE 2.18

By using clipping planes, you can reveal the interior of a model.

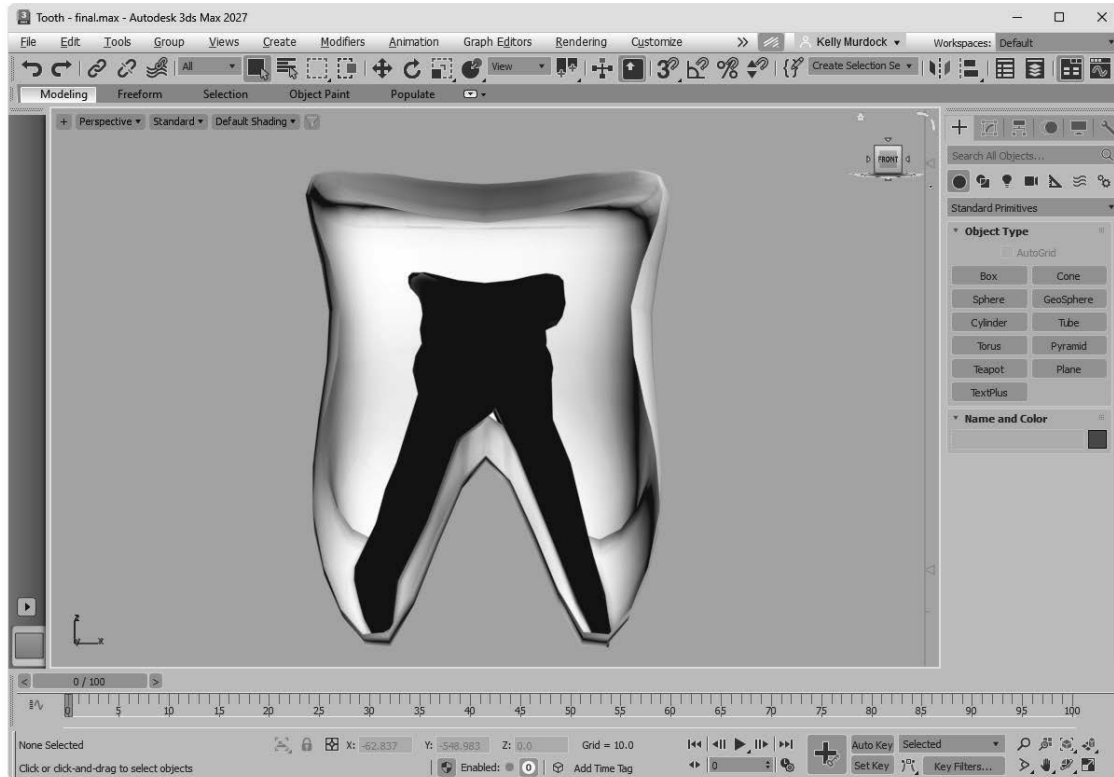

Using Safe Frames

Completing an animation and converting it to some broadcast medium, only to see that the whole left side of the animation is being cut off in the final screening, can be discouraging. If you rely on the size of the active viewport to show the edges of the final output, you could be way off. Using the Safe Frames feature, you can display some guides within the viewport that show where the content must be to avoid such problems.

The Safe Frames panel of the Viewport Configuration dialog box lets you define several safe frame options, as shown in Figure 2.19, including the following:

- * **Live Area:** Marks the area that will be rendered, shown as yellow lines. If a background image is added to the viewport and the Match Rendering Output option is selected, the background image will fit within the Live Area.
- * **Region:** Shows the borders of the defined region rendering limits.
- * **Action Safe:** The area ensured to be visible in the final rendered file, marked with light blue lines; objects outside this area will be at the edge of the monitor and could be distorted.
- * **Title Safe:** The area where the title can safely appear without distortion or bleeding, marked with orange lines.
- * **User Safe:** The output area defined by the user, marked with magenta lines.
- * **12-Field Grid:** Displays a grid in the viewport, marked with a pink grid.

FIGURE 2.19

The Safe Frames panel lets you specify areas to render.

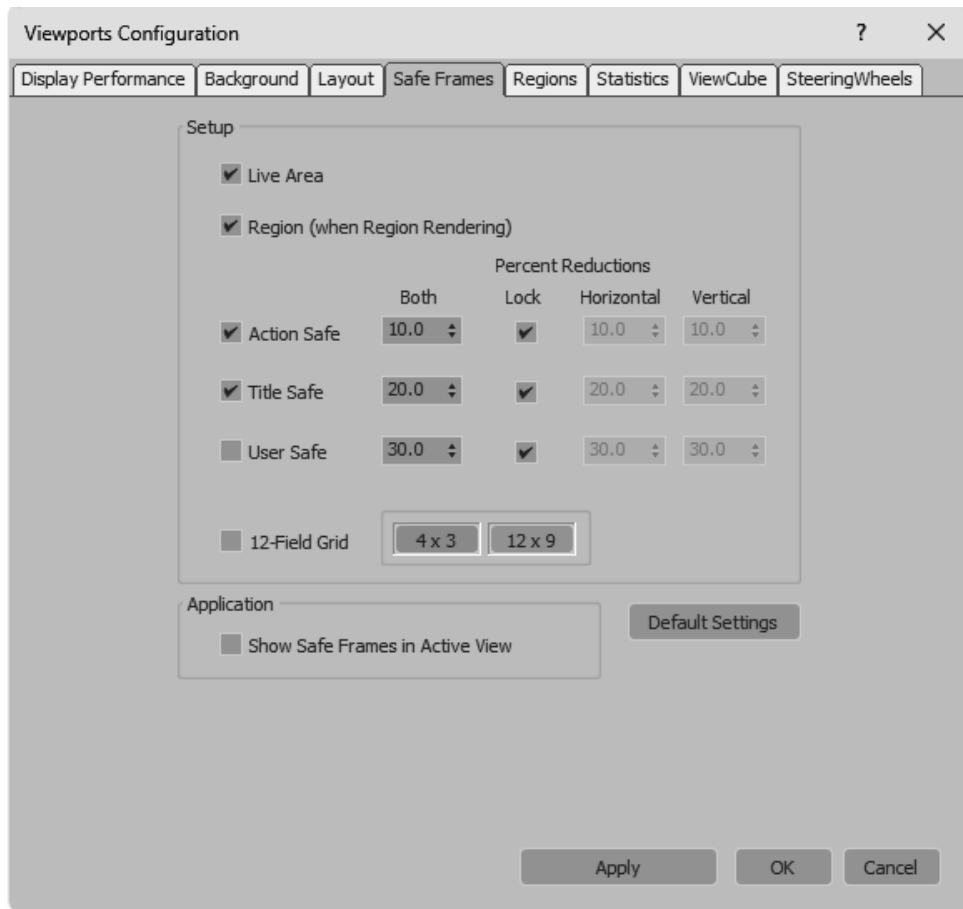

For each type of safe frame, you can set the percent reduction by entering values in the Horizontal, Vertical, or Both fields. The 12-Field Grid option offers 4 x 3 and 12 x 9 layout grids.

The Show Safe Frames in Active View option displays the Safe Frame borders in the active viewport. You can quickly enable or disable Safe Frames by right-clicking the viewport Point-of-View label and choosing Show Safe Frame in the pop-up menu (or you can use the Shift+F keyboard shortcut).

Figure 2.20 shows an elongated Perspective viewport with all the safe frame guides enabled. The Safe Frames show the border where the bottom of my clock tower will be cut off when rendered.

FIGURE 2.20

Safe frames provide guides that help you see when the scene objects are out of bounds.

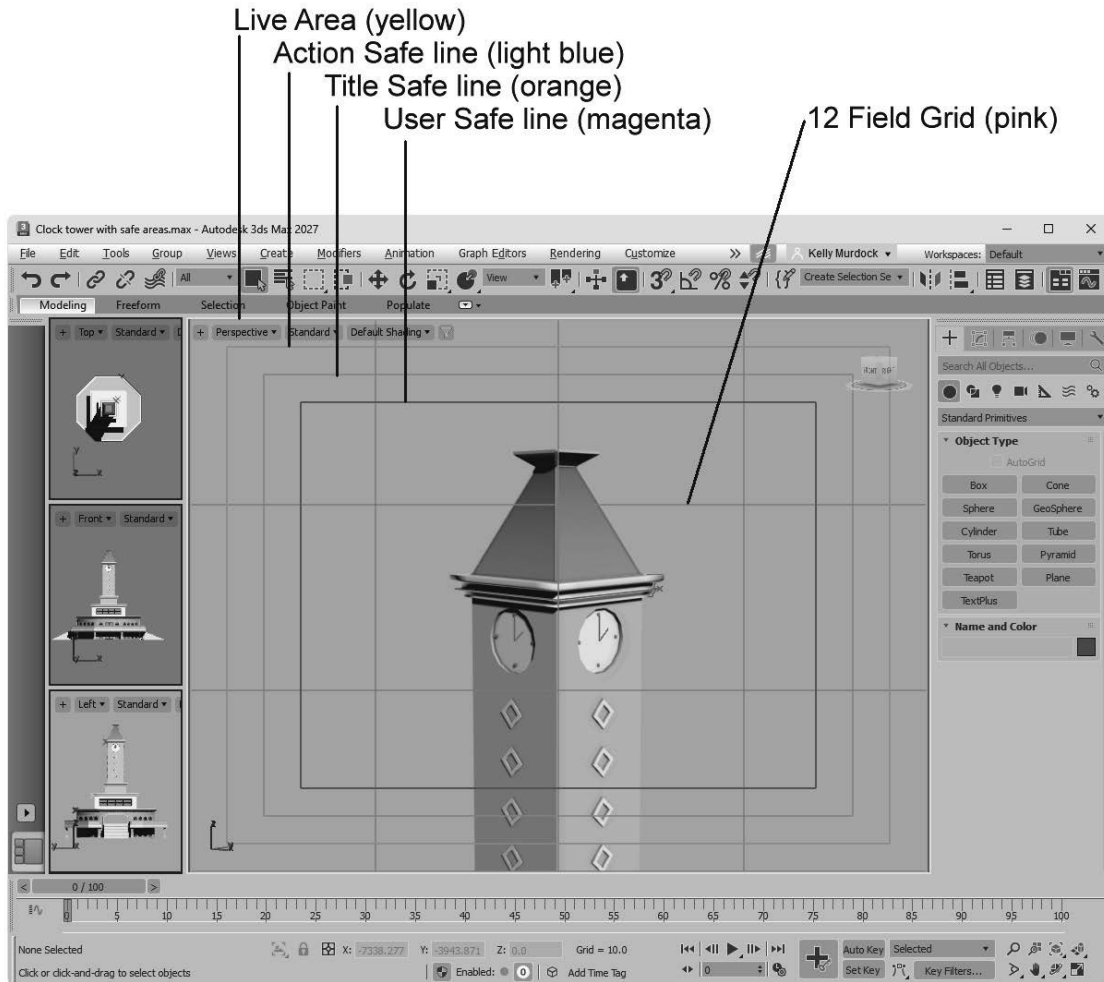

Displaying Materials, Lighting, and Shadows in the Viewport

The difference between what is seen in the viewport and the final render is often the details like materials, lighting, and shadows. Over time, the viewport has gotten stronger and better at being able to display these details without slowing down the system, especially with the latest display drivers. If you are working on a complex scene, you can turn down or turn off these details in order to work faster with the scene.

Viewing materials in the viewports

The Views menu and the Shading Quality viewport label also include several commands for making scene details such as materials, lighting, and shadows visible in the viewports. Each of these options can slow down the refresh rate, but they provide immediate feedback, which is often helpful.

Texture maps also can take up lots of memory. The Materials→Shaded Materials with Maps command in the Shading Quality viewport label shows all applied texture maps in the viewports. If you don't need to see the texture maps, switching to Materials→Shaded Materials without Maps will speed up the display. The option

to use Realistic Materials without Maps and Realistic Materials with Maps uses the video card's memory to display the applied textures. The Materials menu also includes a toggle to Enable Transparency in the viewport.

More on applying texture maps is covered in Chapter 16, "Adding Material Details with Maps."

Overriding materials

Beneath the material options in the Materials menu are several override options. These options will display in the viewport several other visual representations that you might need temporarily. The Override with UV Checker, shown in Figure 2.21, replaces all textures with a UV grid map that helps you identify mapping errors. The Override with Fast Shader shows all objects in a quick flat color designed to render quickly. This provides a quick way to check highlights. The Override with Rendering Setting option replaces the materials with the render quality results. You can remove any of these override options in the viewport with the Override Off option.

FIGURE 2.21

The Override with UV Checker lets you quickly view all textures with a UV grid to see potential problems.



Displaying lighting and shadows in the viewports

Options for enabling lighting and shadow effects within the viewports are located in the Shading Quality viewport label menu. By default, both shadows and ambient occlusion are enabled when the High Quality preset mode is selected, but you can disable them using the toggle menu options under the Lighting and Shadows menu. You also have an option to Illuminate the scene using Scene Lights or Default Lights. Default Lights are simply one or two lights added to the scene if no other lights are present to make sure the scene objects are visible. Figure 2.22 shows an example of viewport shadows and Ambient Occlusion.

FIGURE 2.22

Viewport Shading shown with shadows enabled

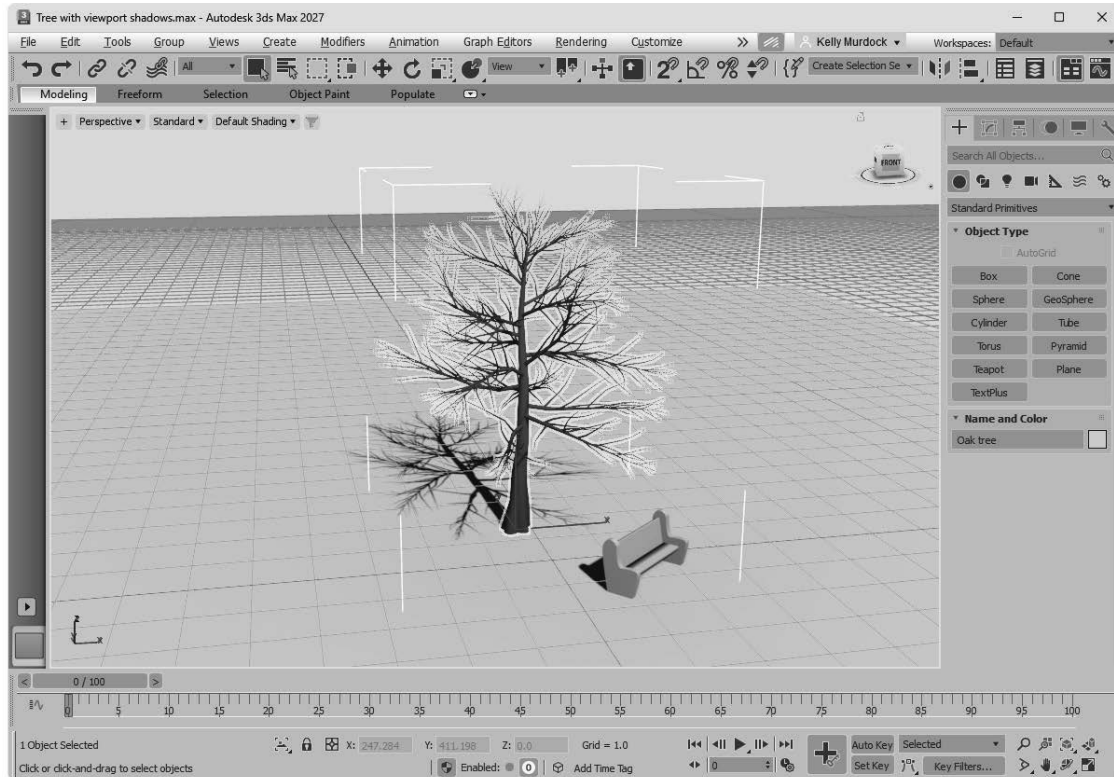

Ambient Occlusion is a lighting effect that adds to the realism of a scene by making objects cast shadows on surrounding objects based on how they block the light. Objects that are close to one another spread a soft shadow onto nearby objects. Within the Settings panel of the Views→Active Viewport Settings, you can turn Ambient Occlusion (AO) for the viewport on and off. You can also set the Radius value, which sets how far the AO spreads and the AO Intensity/Fade, which sets how dark the shadows get.

Figure 2.23 gives a good example of ambient occlusion. The columns in the left viewport have ambient occlusion turned off, but the right columns have it turned on. Notice how the columns on the right cast a light shadow onto the walls and onto the areas around the column caps.

FIGURE 2.23

Ambient Occlusion can often be used as an alternative to full shadows.

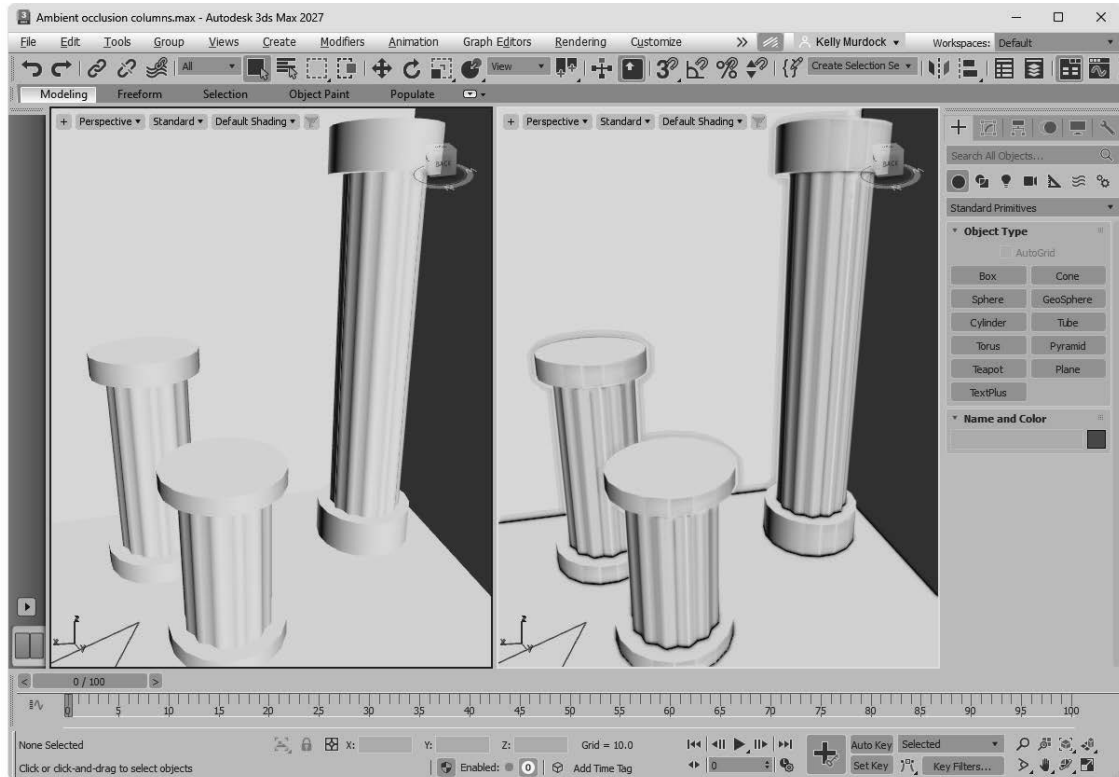

Tutorial: Enabling viewport shadows

To enable and configure lighting and shadows in the viewports, follow these steps:

1. Open the Duck toy.max file from the Chap 02 directory in the downloaded content set.
This file includes a duck pull toy. An Omni light is added to the scene as well.
2. Click in the Shading Quality viewport label, and check the Lighting and Shadows→Shadows option to make sure it is enabled. Then select the Views→Active Viewport Settings menu to open the Settings panel.
3. Enable the Ambient Occlusion setting with a Radius of 10 and an Intensity/Fade value of 1. Select the Point Lights/Soft-Edged Shadows option in the Lighting and Shadows Quality setting. Then close the Viewport Settings dialog box.
4. Click the Select and Move toolbar button, and drag the light object about the scene.
The shadows under the duck toy are automatically updated as the light is moved, as shown in Figure 2.24. Notice that the shadows are soft.

FIGURE 2.24

Lights and shadows are updated in real time when the light is moved about the scene.

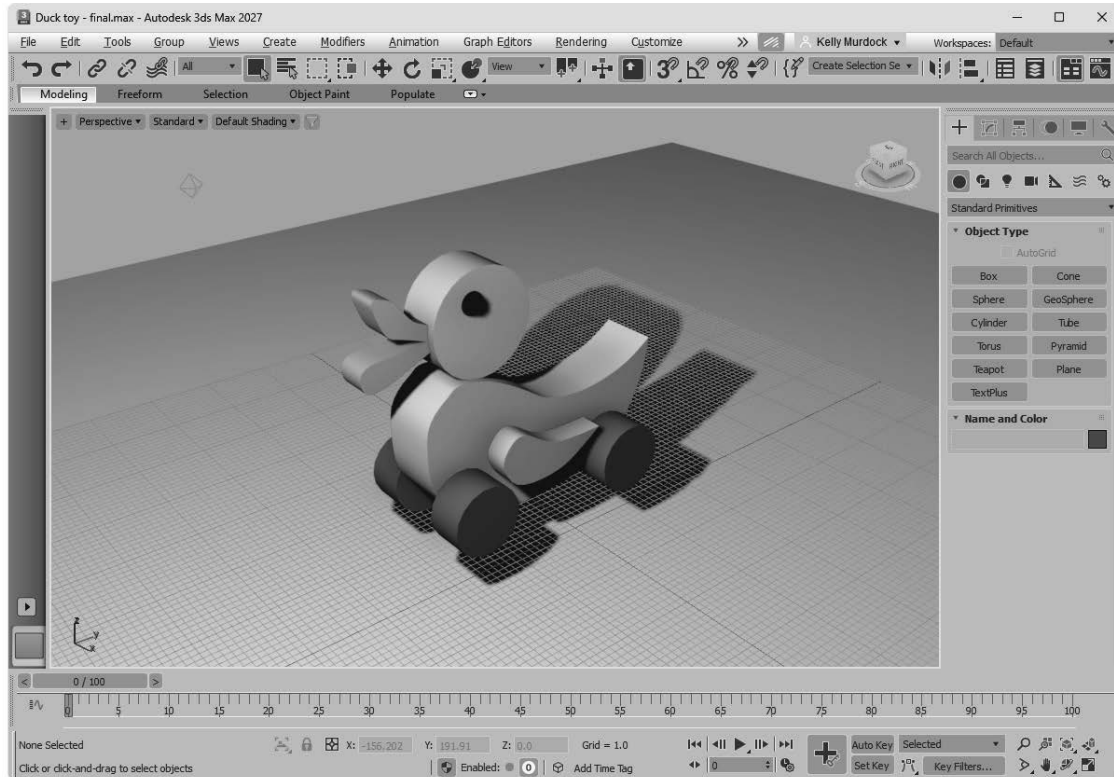

Configuring viewport lighting and shadows

The Settings panel of the Active Viewport Settings dialog box includes a number of settings for the viewport lighting and shadows. This panel includes options to illuminate the scene with Default lights (either one or two) or with Scene lights, just like the viewport Shading label menu. The one-light option creates a single light positioned behind the viewer and at an angle to the scene. Scenes with one light update more quickly than scenes with two lights.

The Default Lights option deactivates your current scene lights and uses the default lights. This option can be helpful when you're trying to view objects in a dark setting because the default lighting illuminates the entire scene without requiring you to remove or turn off lights.

The Lighting and Shadows Quality drop-down list lets you select from several different quality settings. The options include Point Lights/Hard Shadows, Point Lights/Soft-Edged Shadows and quality levels from 0.125X-Very Low to 16X-Very High Quality. The higher quality options can take longer to render and use area lights to improve the quality.

Beneath the Lighting and Shadows Quality setting is an option to turn lighting Highlights on or off and an option to Auto Display Selected Lights. This option also is available in the Lighting and Shadows menu in the Shading Quality viewport label. It is helpful when you're placing and aiming lights in the scene. It causes the selected light to be displayed in the shaded viewport automatically. There is also an option to turn on the environment reflections. The option to enable a Progressive Skylight is another way to add lighting to the viewport scene. For outdoor scenes, this skylight shows realistically accurate shadows in the viewport, but it can cause a flicker effect. To control how quickly the progressive skylight is rendered in the viewport, you can set the Progressive Fade-In Time slider.

Within the Shadows section are options to set the number of Samples, adjust the Intensity/Fade value for shadows and the Radius and Intensity/Fade amount of the Ambient Occlusion effect. These values are used to override the Viewport Shadow Intensity to dim the shadows if they are too dark. The Radius value sets how close objects need to be in order to be included in the ambient occlusion solution.

Configuring viewport preferences

Viewport specific preferences are located in the Viewports panel of the Preference Settings dialog box. The Use Dual Planes option enables a method designed to speed up viewport redraws. Objects close to the scene are included in a front plane, and objects farther back are included in a back plane. When this option is enabled, only the objects on the front plane are redrawn.

In subobject mode, the default is to display vertices as small plus signs. The Show Vertices as Dots option displays vertices as either Small or Large dots. The Draw Links as Lines option shows all displayed links as lines that connect the two linked objects.

Caution

I've found that keeping the Draw Links as Lines option turned on can make it confusing to see objects clearly, so I tend to keep it turned off, but it is occasionally useful when trying to determine which objects are linked and to which other object.

When the Backface Cull on Object Creation option is enabled, the backside of an object in wireframe mode is not displayed. If disabled, you can see the wireframe lines that make up the backside of the object. The Backface Cull option setting is determined when the object is created, so some objects in your scene may be backface culled and others may not be. Figure 2.25 includes a sphere and a cube on the left that are not backface culled and a sphere and cube on the right that are.

Note

The Object Properties dialog box also contains a Backface Cull option.

FIGURE 2.25

Backface culling simplifies objects by hiding their backsides.

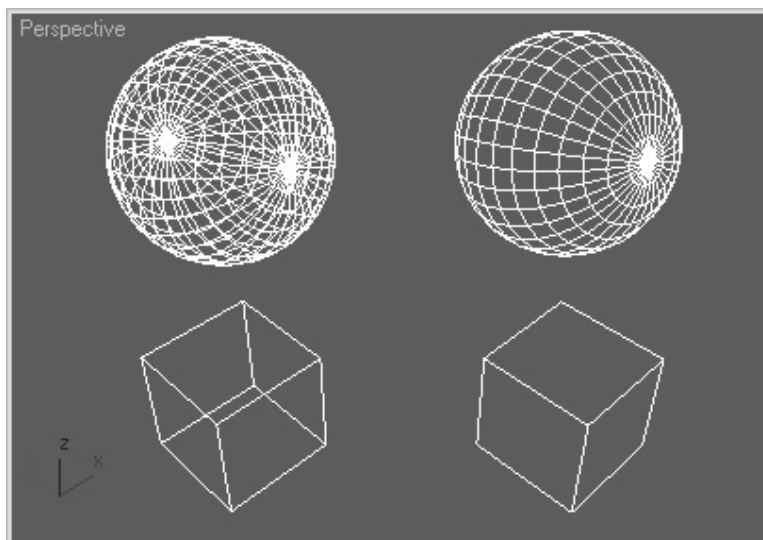

The Attenuate Lights option causes objects farther back in a viewport to appear darker. Attenuation is the property that causes lights to diminish over distance.

In the Viewport Configuration dialog box, you can set Safe Regions, which are borders that the renderer includes. The Mask Viewport to Safe Region option causes the objects beyond the Safe Region border to be invisible.

The Update Background While Playing option causes viewport background bitmaps to be updated while an animation sequence plays. Viewport backgrounds can be filtered if the Filter Environment Background option is enabled, but this slows the update time. If this option is disabled, the background image appears aliased and pixelated.

The Display World Axis option displays the axes in the lower-left corner of each viewport. This can be helpful as you learn to navigate in 3D space. The Grid Nudge Distance is the distance that an object moves when Grid Nudge (+ and – on the numeric keypad) keys are used. Objects without scale, such as lights and cameras, appear in the scene according to the Non-Scaling Object Size value. Making this value large makes lights and camera objects very obvious.

Working with Viewport Backgrounds

Remember in grade school when you realized that you could immediately draw really well using tracing paper (where all you needed to do was follow the lines)? Well, it's not quite tracing paper, but you can load background reference images into a viewport that can help as you create and position your objects.

Changing the viewport background

The Views→Viewport Background menu command includes submenus for switching the viewport background between a gradient and solid color. You also have options to display the Environment Background or a custom image file.

The default gradient is set to display dark gray at the top of the viewport and gradually changes to a lighter gray at the bottom. You can alter the displayed colors using the Colors panel in the Customize User Interface dialog box opened using the Customize menu. Look for the Viewport Background, Viewport Gradient Background Bottom, and Viewport Gradient Background Top entries.

Loading viewport background images

To create a background image to be rendered along with the scene, you need to choose the Environment Background option and specify the background in the Environment dialog box, opened using the Rendering→Environment (keyboard shortcut, 8) menu command. If an environment map is already loaded into the Environment dialog box, you can simply click the Use Map option. Keep in mind that the background image will not be rendered unless it is used as an Environment map.

Environment maps are covered in Chapter 18, "Configuring Cameras and Environments."

To load images into the viewport background, select the Custom Image File option in the Views→Viewport Background menu, and then use the Views→Viewport Background→Configure Viewport Background menu command (Alt+B) to open a dialog box, shown in Figure 2.26, where you can select an image or animation to appear behind a viewport. Each viewport can have a different background image. The displayed background image is helpful for aligning objects in a scene, but it is for display purposes only and will not be rendered.

FIGURE 2.26

The Background panel in the Viewport Configuration dialog box lets you select a background source image or animation.

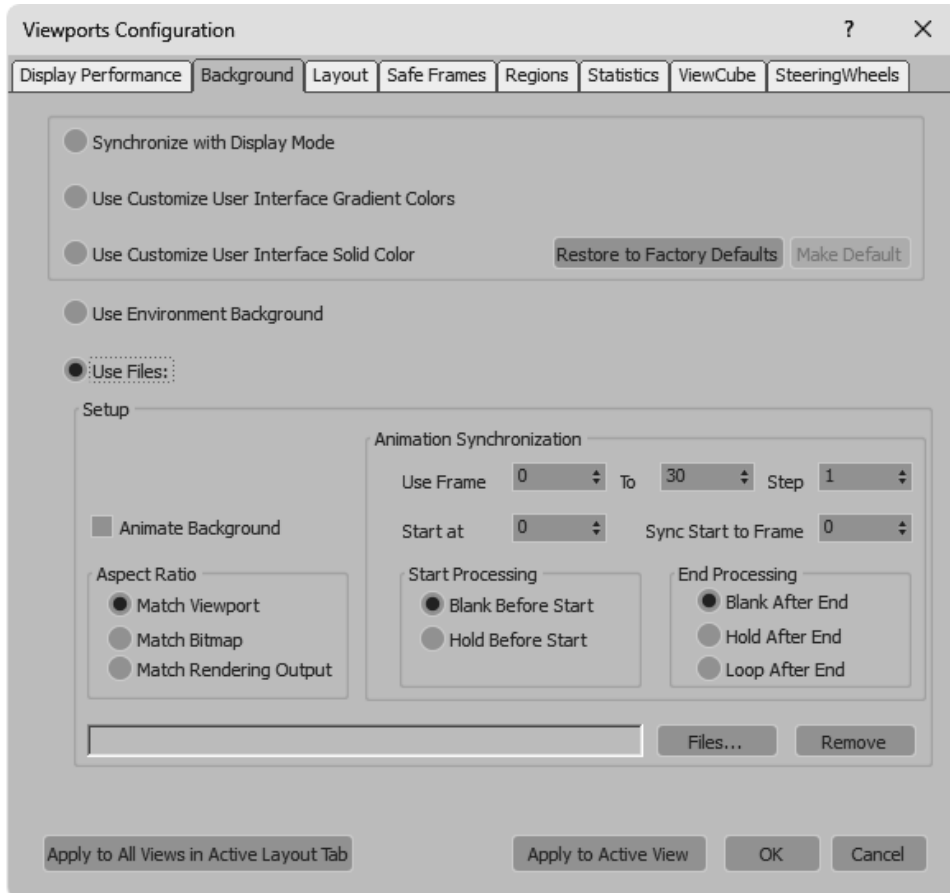

The Environment Background is set using the Background color swatch and Environment Map button located in the Environment and Effects dialog box. You can open this panel with the Rendering→Environment menu or by pressing the 8 key. The benefit of using an environment background is that it renders with the scene objects where viewport background images are not.

The Files button in the Background panel of the Viewport Configuration dialog box opens the Select Background Image dialog box, where you can select the image to load. Once an image is selected, its path is added to the Background panel of the Viewport Configuration dialog box. You can remove the designated file path by clicking the Remove button. The Aspect Ratio section offers options for setting the size of the background image. You can select to Match Viewport, Match Bitmap, or Match Rendering Output.

Loading viewport background animations

The Animation Synchronization section of the Background panel lets you set which frames of a background animation sequence are displayed. The Use Frame and To values determine which frames of the loaded animation are used. The Step value trims the number of frames that are to be used by selecting every Nth frame. For example, a Step value of 4 would use every fourth frame.

Tip

Loading an animation sequence as a viewport background can really help as you begin to animate complex motions, like a running horse. By stepping through the frames of the animation, you can line up your model with the background image for realistic animations.

The Start At value is the frame in the current scene where this background animation would first appear. The Sync Start to Frame value is the frame of the background animation that should appear first. The Start and End Processing options let you determine what appears before the Start and End frames. Options include displaying a blank, holding the current frame, and looping. Make sure to enable the Animate Background option in order to play the background animation when the animation plays.

You can set the Apply to All Views in the Active Layout Tab or the Apply to Active View option to display the background in All Views or in the active viewport only.

Tutorial: Loading reference images for modeling

When modeling a physical object, you can get a jump on the project by taking pictures with a digital camera of the front, top, and left views of the object and then loading them as background images in the respective viewports. The background images can then be a reference for your work. This is especially helpful with models that need to be precise. You can even work from CAD drawings.

To load the background images of a brass swan, follow these steps:

1. Choose File→New (or press Ctrl+N) to open a blank scene file. Select New All in the New Scene dialog box.
2. Right-click the Front viewport to make it the active viewport, and choose Views→Viewport Background→Configure Viewport Background (or press Alt+B).
The Background panel of the Viewport Configuration dialog box opens.
3. Enable the Use Files option, click the Files button, and in the Select Background Image dialog box that opens, select the Brass swan-front view.jpg image from the Chap 02 directory in the downloaded content set. Then click Open.
4. Select the Match Bitmap option and click the Apply to Active View button, then click OK to close the dialog box.
The image now appears in the background of the Front viewport.
5. Repeat Steps 2 through 4 for the Top and Left viewports.
6. Zoom and pan each view until the image is centered in the background.

Figure 2.27 shows the 3ds Max interface with background images loaded in the Front, Top, and Left viewports.

FIGURE 2.27

Adding a background image to a viewport can help as you begin to model objects.

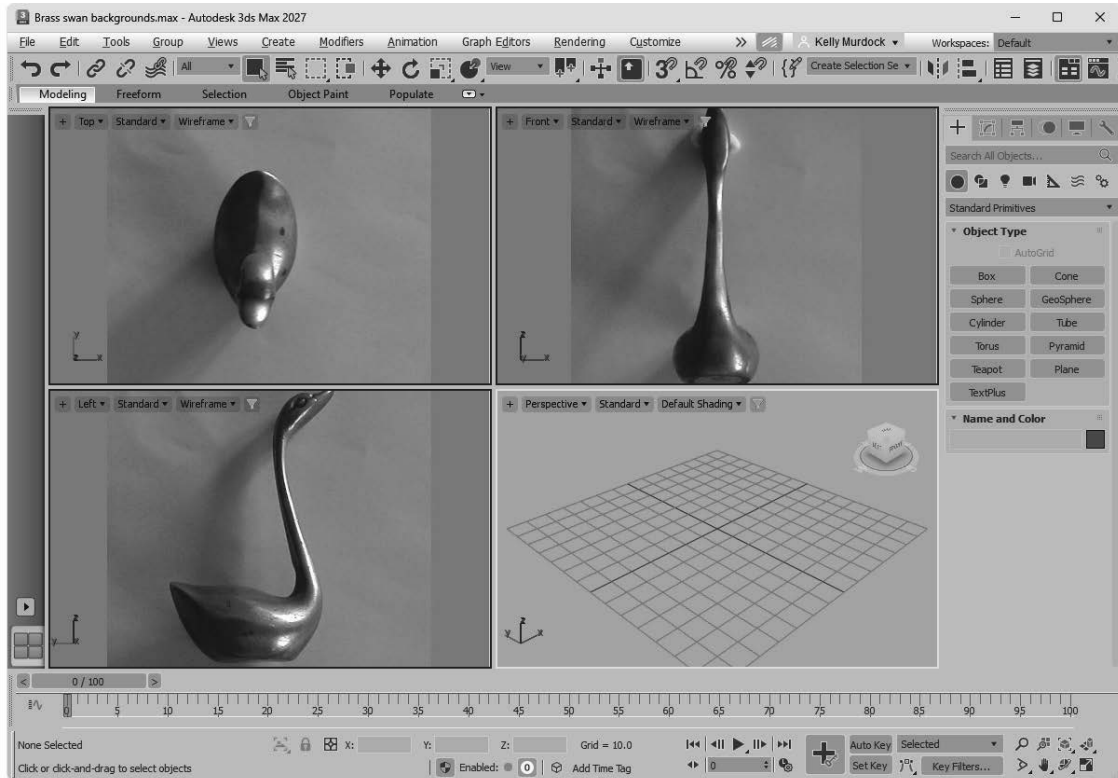

Setting Viewport Visual Style and Appearance

The Active Viewport Setting dialog box, shown in Figure 2.28, holds all the visual settings of the viewports. It also holds several presets that you can quickly select. You can access it using the Views→Active Viewport Settings menu. It is also accessible from the Shading Quality viewport label menus. Using this dialog box, you can configure how the scene objects are rendered within the viewports.

The Active Viewport Setting dialog box is divided into three panels-- Settings, Preferences, and Filter. There is an option at the bottom of the dialog box that lets you apply the changes to all views. This lets you make changes to many viewports at once.

FIGURE 2.28

The Active Viewport Settings dialog box (split in half for figure) sets how the scene objects are displayed.

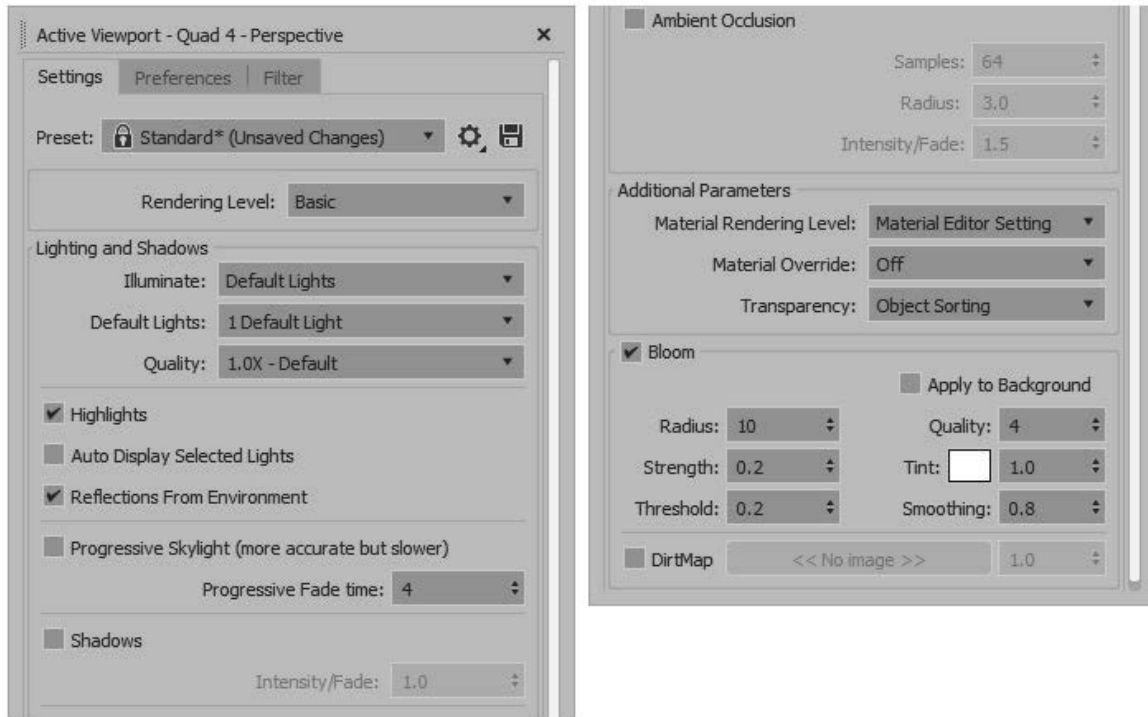

At the top of the Settings panel is a drop-down list of several presets including High-Quality, Standard, Performance and DX Mode. The High-Quality setting uses scene lights, shadows, ambient occlusion, Progressive Skylight, and reflections. The Standard preset disables shadows, skylights, and ambient occlusion, but keeps reflections enabled and uses the default lights. The Performance preset also uses default lights and skylights but disables reflections and uses basic materials on all objects. The DX Mode preset uses DirectX shader materials. You can also configure and save your own custom presets. The Rendering Level setting can be set to Advanced, Basic or DX.

Using the Rendering levels

The Preference drop-down list in the Preferences panel includes all the shading options found in the Shading viewport label, including all the Stylized non-photorealistic options.

Tip

If you ever get stuck waiting for 3ds Max to complete a task, such as redrawing the viewports, you can always press the Escape key to suspend any task immediately and return control to the interface.

Note

These settings have no effect on the final rendering specified using the Render Setup dialog box. They affect only the display in the viewport.

Figure 2.29 shows some stylized display options.

FIGURE 2.29

Stylized renders here include Pastel and Color Pencil along the top and Tech and Color Ink along the bottom.

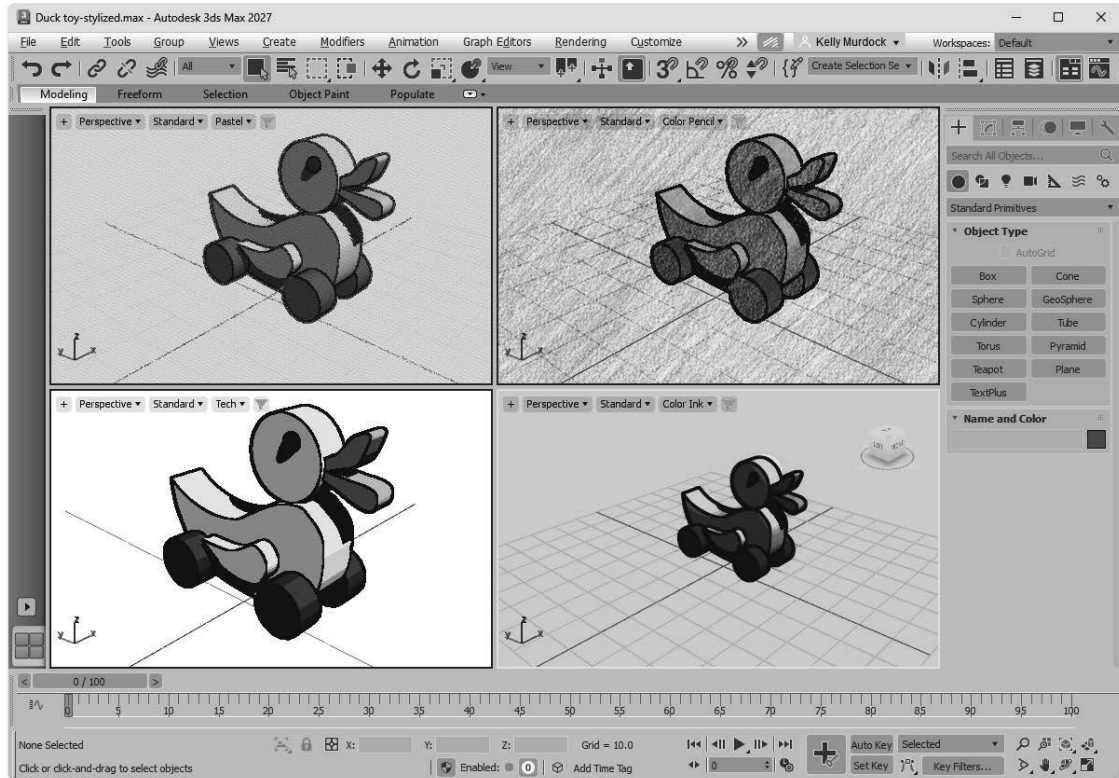

Viewing transparency

In addition to these shading types, you also can set the viewport to display objects that contain transparency (which is set in the Material Editor). The Enable Transparency option is found in the Materials submenu for the Views menu and the Shading Quality viewport label. The Stochastic Transparency option is located in the Settings panel of the Active Viewport Settings dialog box. Figure 2.30 shows the transparency option disabled and enabled with the help of a hungry little animated creature and his ghostly rival.

FIGURE 2.30

Transparency in the viewport can be enabled using the Materials menu in the Shading Quality viewport label.

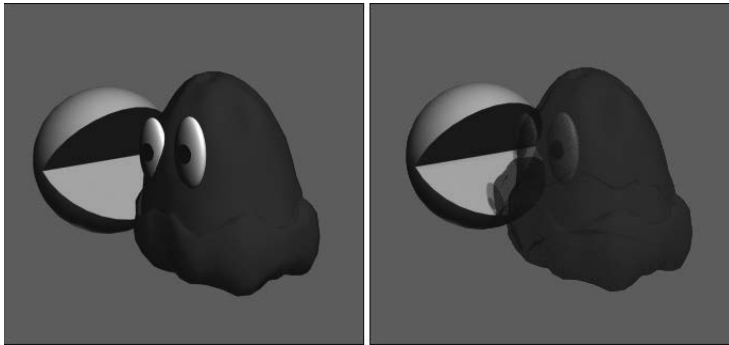

Other rendering options

Within the Preference panel of the Active Viewport Settings dialog box are several options that make it easier to see the selected object and/or subobjects. The Selection Brackets option displays white corners around the current selection. Selection brackets are useful for helping you see the entire size of a grouped object but can be annoying if left on with many objects selected. Uncheck this option to make these brackets disappear. The option to Display Selected with Edged Faces helps to highlight the selected object. If this option is enabled, the edges of the current selection are displayed regardless of whether the Edged Faces check box is enabled. Figure 2.31 shows the beak of a cartoon chicken selected with the Use Selection Brackets options enabled. These options make the current selection easy to see.

FIGURE 2.31

The Display Selected with Edged Faces and Use Selection Brackets options make identifying the current selection easy.

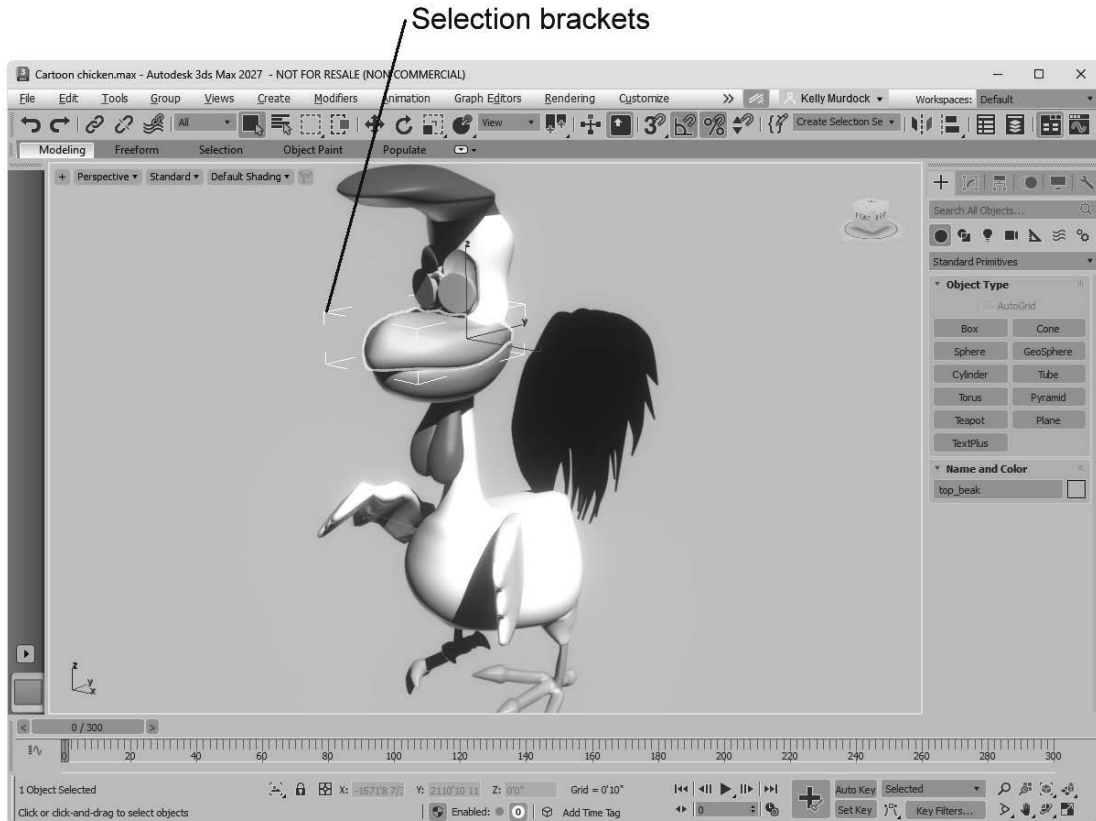

You can use Shade Selected Faces (F2) option to shade selected subobject faces in red, making them easy to see. The Shade Selected Objects option causes the selected object to be shaded. This is noticeable only if the render level is set to Wireframe or Hidden Line. It causes the selected object to be shaded.

Note

The Shade Selected Faces (F2) option, which shades selected subobject faces, is different from the Views→Shade Selected menu command, which turns on shading for the selected object in all viewports.

Setting the Field of View

You also can alter the Field of View (FOV) for the Perspective viewport in the Preferences panel of the Active Viewport Settings dialog box. To create a fish-eye view, decrease the FOV setting to 10 or less. The maximum FOV value is 180, and the default value is 45. You also can change the Field of View using the Field of View button in the Viewport Navigation Controls. The setting in the Preferences panel, however, lets you enter precise values.

See Chapter 18, “Configuring Cameras and Environments,” for more coverage on Field of View.

Grabbing a viewport image

It’s not rendering, but you can grab an image of the active viewport using Tools→Preview - Grab Viewport→Capture Still Image. This option is also available in the Create Preview menu in the General

Viewport label. Before grabbing the image, a simple dialog box appears asking you to add a label to the grabbed image. The image is loaded into the Rendered Frame Window, and its label appears in the lower-right corner of the image. The Tools→Preview - Grab Viewport menu also includes options for creating, viewing, and renaming animated sequence files, which provides a quick way to create animation previews.

Tip

If you want to save the image loaded in the Rendered Frame Window, simply click the Save Image button. You also can copy, clone, and print from this same window.

More on working with animation previews is covered in Chapter 21, “Understanding Animation and Keyframes.”

Setting Display Performance

Within the Display Performance panel of the Viewport Configuration dialog box, shown in Figure 2.32, are a couple of simple settings. The Improve Quality Progressively setting causes a rough approximation of the viewport update to be rendered immediately, and gradually the details are added to improve the displayed results as time progresses. This progressive update doesn't slow you down but provides more detail if there is time to add it before the next update.

You also can set the display resolution used on procedural maps. Higher resolution values have more detail, and lower resolution maps render and are updated more quickly.

FIGURE 2.32

The Display Performance panel offers only a few simple settings.

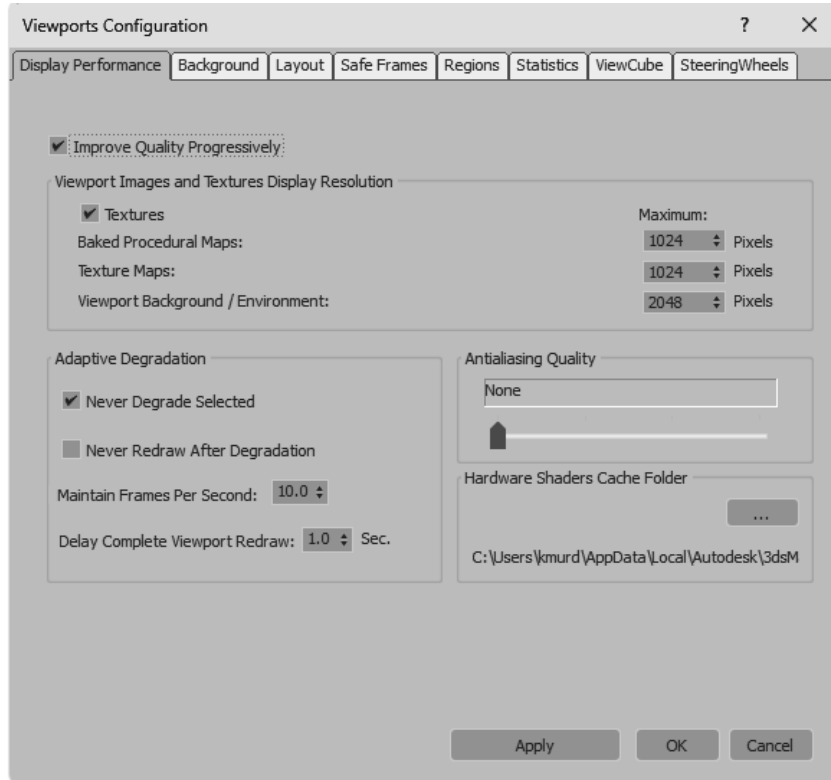

You can enable Progressive Display option using the Views→Progressive Display menu command. You also can turn Adaptive Degradation on and off with a button located at the bottom of the interface between the Prompt Bar and the Add Time Tag (or by pressing the O key). The Adaptive Degradation button looks like a simple cube.

Tip

Right-clicking the Progressive Display button opens the Display Performance panel in the Viewport Configuration dialog box.

Defining Regions

The Regions panel enables you to define regions and focus your rendering energies on a smaller area. Complex scenes can take considerable time and machine power to render. Sometimes, you want to test render only a portion of a viewport to check material assignment, texture map placement, or lighting.

You can define the size of the various regions in the Regions panel of the Viewport Configuration dialog box, shown in Figure 2.33.

FIGURE 2.33

The Regions panel enables you to work with smaller regions within your scene.

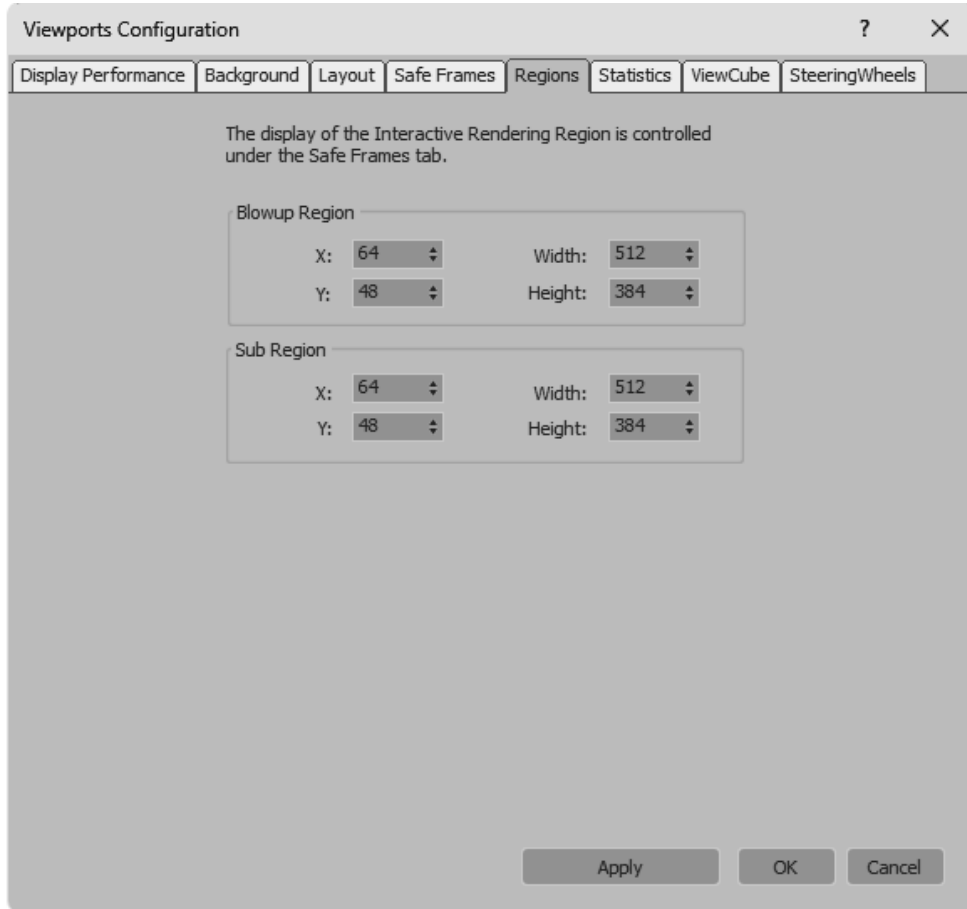

After you've specified a Blowup Region or a Sub Region, you can select to render using these regions by selecting Region or Blowup from the Render Frame Window and clicking the Render button. If you click the Edit Region button, the specified region is displayed as an outline in the viewport. You can move this outline to reposition it, or drag its edge or corner handles to resize the region. The new position and dimension values are updated in the Regions panel for next time. Click the Render button to begin the rendering process.

The difference between these two regions is that the Sub Region displays the Rendered Frame Window in black, except for the specified sub-region. The Blowup Region fills the entire Rendered Frame Window using the specified dimensions.

You can learn more about Render Types and the Rendered Frame Window in Chapter 20, "Rendering a Scene and Working with Arnold."

FIGURE 2.34

This image was rendered using the Sub Region option, which renders only a portion of the scene.

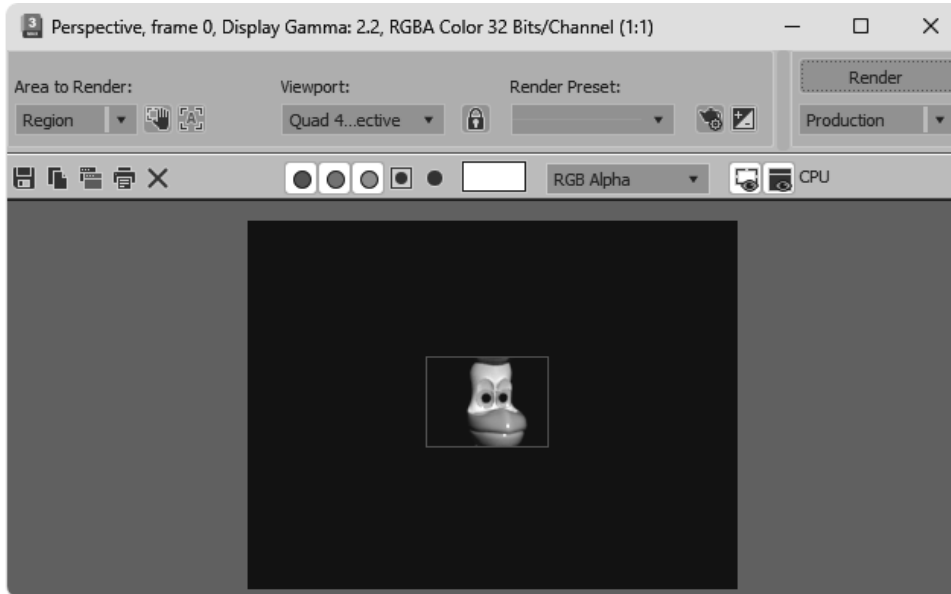

Summary

Viewports are the windows into the 3ds Max world. Remember that if you can't see it, you can't work with it, so you need to learn to use the viewports. You also can configure viewports to display just the way you desire. Most of the commands for working with the viewports are located in the Views menu and in the various viewport labels, but all the configuration settings are located in the Viewport Configuration dialog box. Using these settings, you can configure viewports to display just the way you desire.

This chapter covered the following topics:

- * Understanding 3D space and the various viewport points-of-view
- * Navigating with the ViewCube, the SteeringWheels, and the scroll wheel
- * Using the various Viewport Navigation Control buttons
- * Changing the visual style of the viewport
- * Changing the viewport layout, xView, clipping planes, and safe frames
- * Turning materials, lighting, and shadows on and off in the viewport
- * Working with viewport background colors, gradients, and images
- * Changing settings in the Active Viewport Settings dialog box
- * Discovering the other panels of the Viewport Configuration dialog box that allow you to change the display performance, regions, and statistics

In the next chapter, you find out all the details about working with files, including loading, saving, and merging scene files. The next chapter also covers import and export scene files for interfacing with other software packages.

